

Full Color PLCC4 LED

OVSARGB3R8

- Surface mount device packaged in 8mm tape on 7" diameter reel
- Compatible with automatic placement equipment
- Compatible with infrared and vapor phase reflow solder
- Pb-free, RoHS-compliant
- Dimensions: 3.5x2.8x1.9mm
- 120° viewing angle



The OVSARGB3R8 provides full color light output from a single package, 3-die design. This surface mount package is an efficient solution in modular applications that require uniform brightness and color-on-demand. Light output is optimized by an interior reflector and the wide viewing angle adds flexibility for applications ranging from hand-held appliances to automotive interiors.

Applications

- RGB+White Full-color Indoor and Outdoor Displays
- Backlighting
- Coupling into Lightguides
- Automotive Interiors
- Entertainment Equipment

Part Number	Chip				Lens Color
	Type	Material	Emitted Color	Intensity Typ. mcd	
OVSARGB3R8	R	AlInGaP	Red	300	Water Clear
	G	InGaN	Green	450	
	B	InGaN	Blue	110	

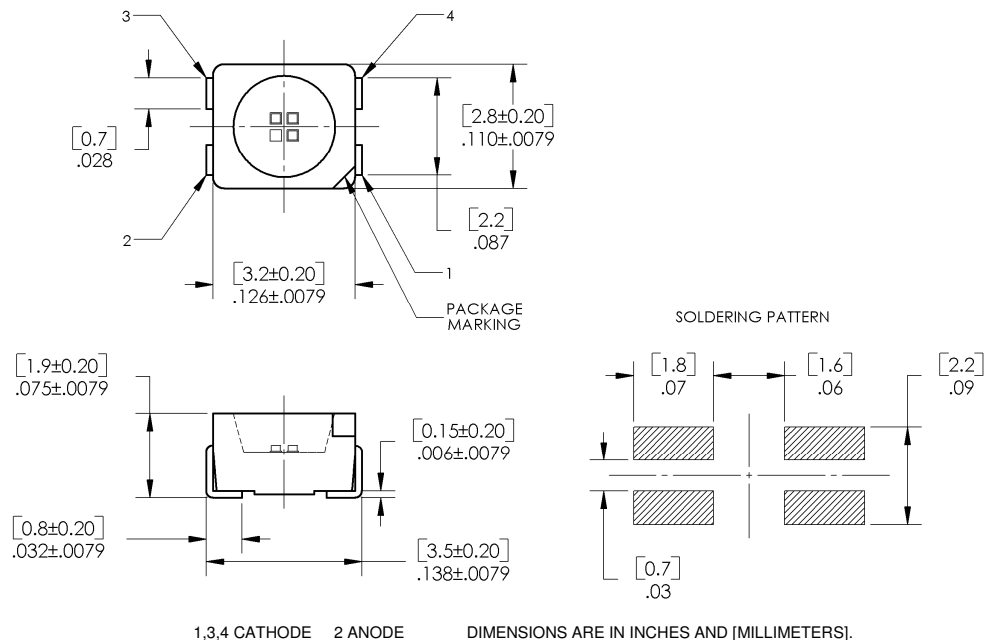

Data is subject to change without prior notice.

Full-Color PLCC4 LED

OVSARGB3R8



Absolute Maximum Ratings

$T_A = 25^\circ\text{C}$ unless otherwise noted

PARAMETER	RATING			UNIT
	R	G	B	
Storage Temperature	-40 ~ +100			$^\circ\text{C}$
Operating Temperature	-40 ~ +100			$^\circ\text{C}$
Reverse Voltage	5			V
Continuous Forward Current ¹	50	25	25	mA
Peak Forward Current (10% Duty Cycle, PW \leq 100 μsec)	200	100	100	mA
Power Dissipation	130	105	105	mW
Junction Temperature	110	110	110	$^\circ\text{C}$
Junction/ambient (1 chip on ²)	450	400	450	$^\circ\text{C}/\text{W}$
Junction/ambient (3 chips on ²)	650	580	680	$^\circ\text{C}/\text{W}$
Junction/solder point (1 chip on)	300	280	300	$^\circ\text{C}/\text{W}$
Junction/solder point (3 chips on)	450	430	480	$^\circ\text{C}/\text{W}$

Notes:

1. Single color light
2. Rth test condition: Mounted on PC Board FR 4 (pad size \geq 16mm²)

Electrical Characteristics

$T_A = 25^\circ\text{C}$ unless otherwise noted

SYMBOL	PARAMETER	VALUES			UNIT	CONDITIONS	
		R	G	B			
I_V	Luminous Intensity	Min	180	280	71	mcd	$I_F = 20\text{mA}$
		Typ	300	450	110		
V_F	Forward Voltage	Typ	2.3	3.6	3.6	V	$I_F = 20\text{mA}$
		Max	2.6	4.2	4.2		
I_R	Reverse Current (max)	10	10	10	μA	$V_R = 5\text{V}$	
λ_D	Dominant Wavelength	612–625	520–540	460–480	nm	$I_F = 20\text{mA}$	
λ_P	Wavelength at Peak Emission	620	520	465	nm	$I_F = 20\text{mA}$	
$2\Theta_{1/2}$	50% Power Angle	120	120	120	deg	$I_F = 20\text{mA}$	
$\Delta\lambda$	Spectrum Radiation Bandwidth	24	38	28	nm	$I_F = 20\text{mA}$	

Full-Color PLCC4 LED

OVSARGB3R8

Standard Bins ($I_F=20\text{mA}$)

Lamps are sorted to luminous intensity (I_V) and dominant wavelength (λ_D) bins shown. Orders for OVSARGB3R8 may be filled with any or all bins contained as below.

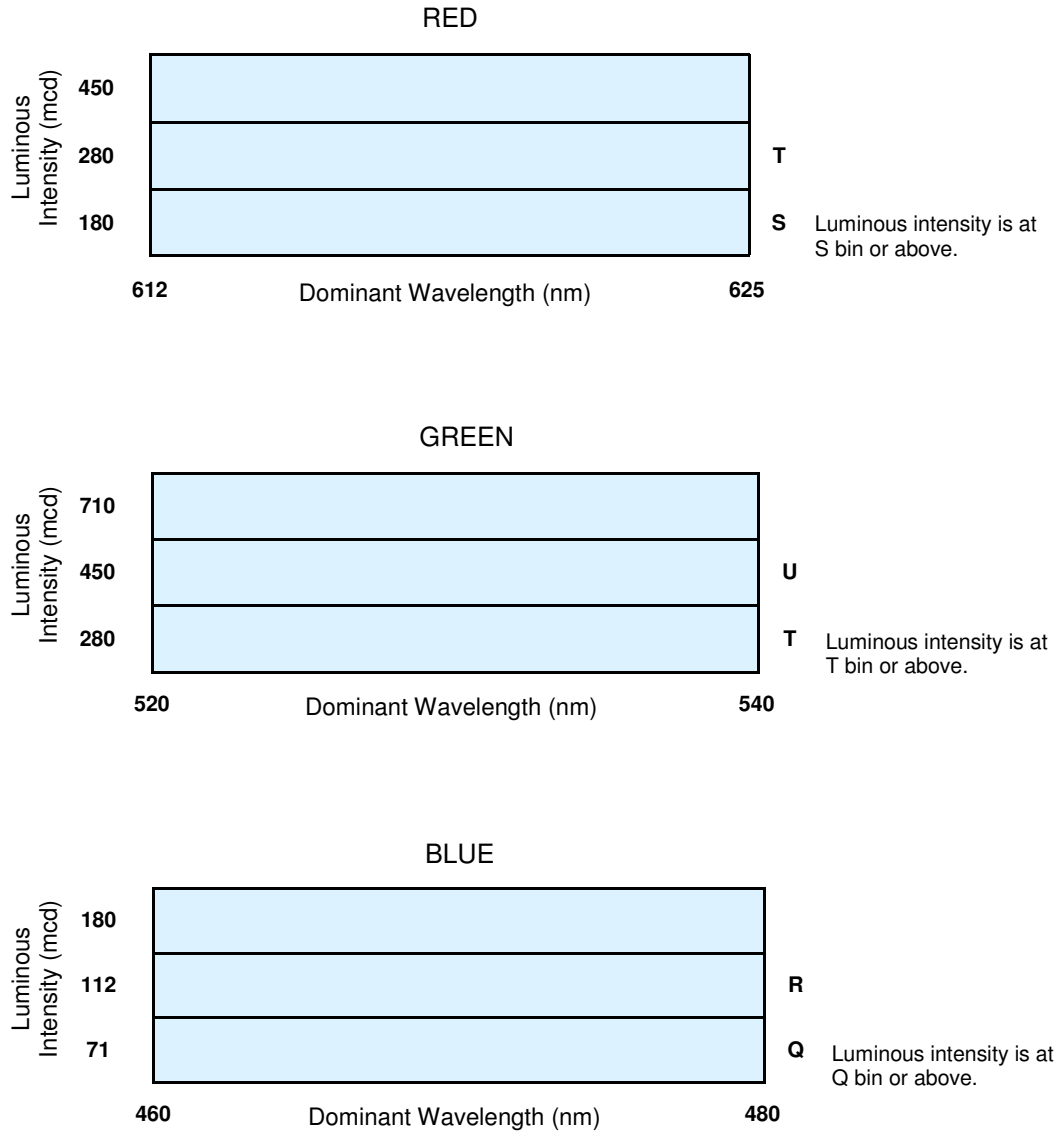

Important Notes:

1. All ranks will be included per delivery, rank ratio will be based on the chip distribution.
2. Tolerance of measurement of luminous intensity is $\pm 10\%$.
3. Tolerance of measurement of dominant wavelength is $\pm 1\text{nm}$.
4. Tolerance of measurement of V_F is $\pm 0.05\text{V}$.

Typical Electro-Optical Characteristics Curves

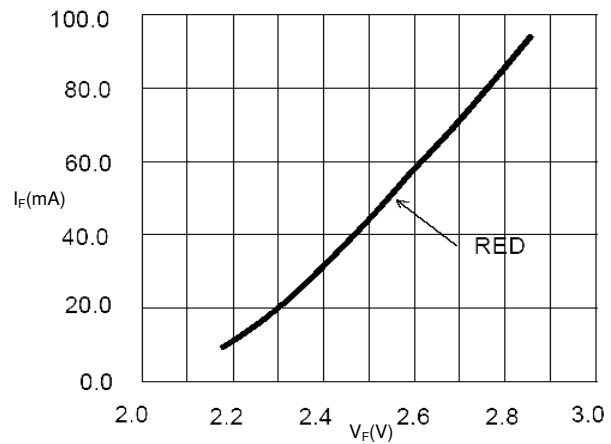
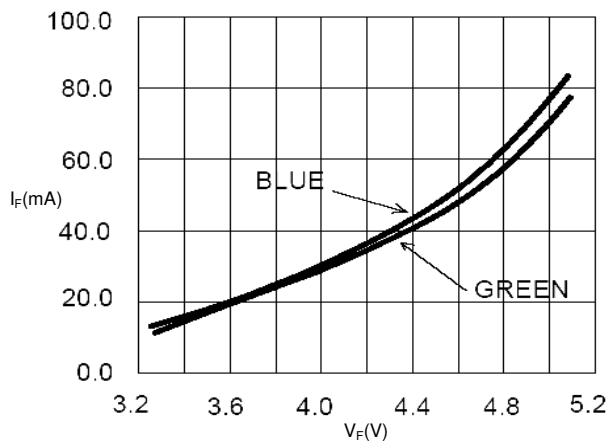
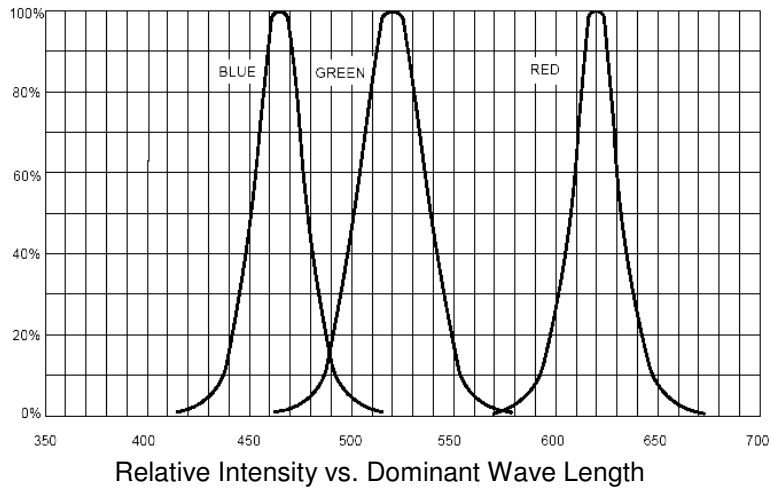

Forward Current vs. Forward Voltage

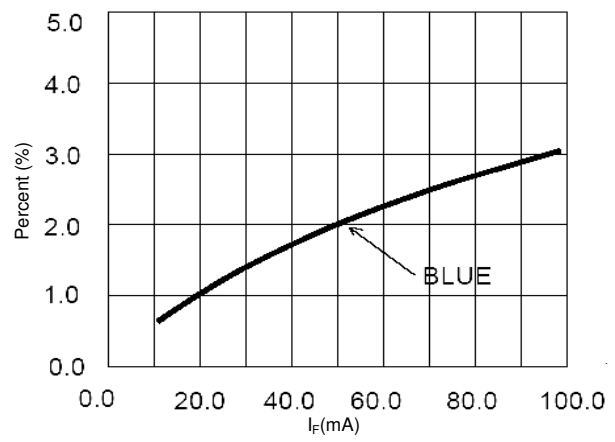
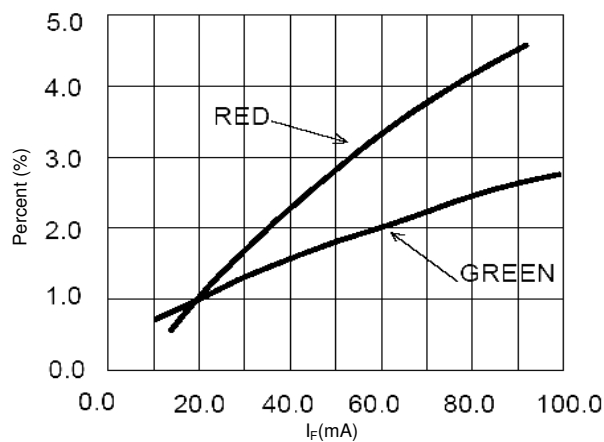

Relative Luminous Intensity vs. Forward Current

Typical Electro-Optical Characteristics Curves

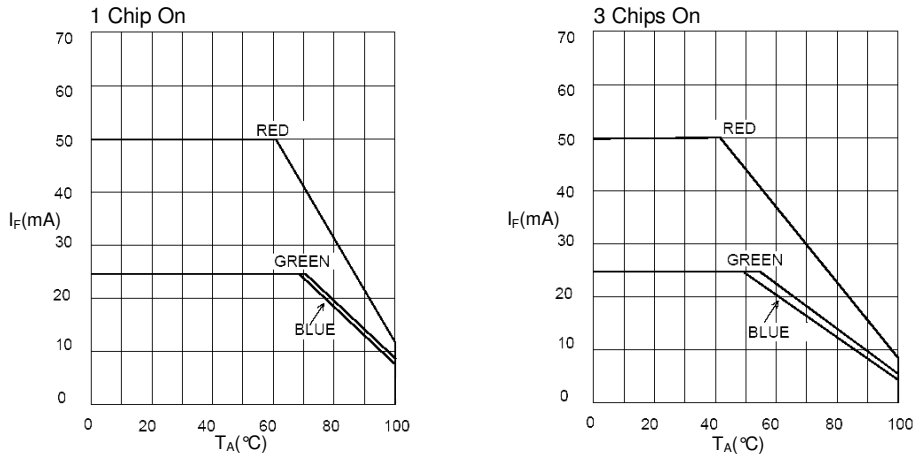

Maximum Forward DC Current vs. Solder Point Temperature

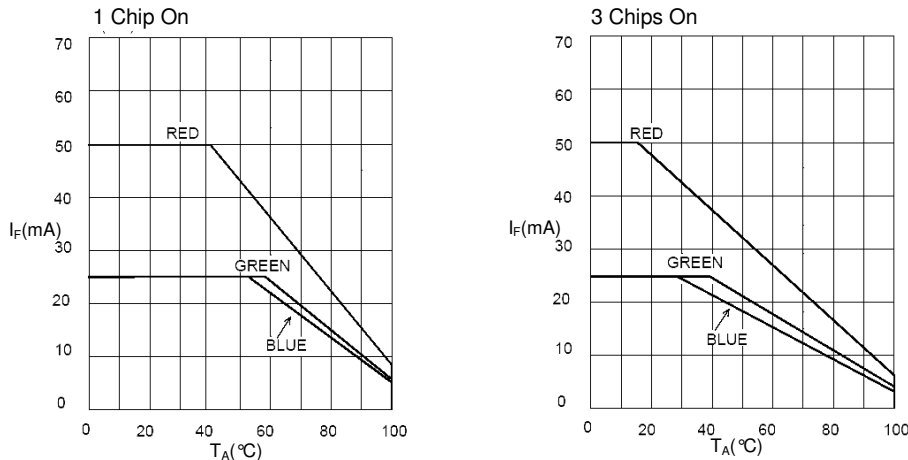

Maximum Forward DC Current vs. Ambient Temperature

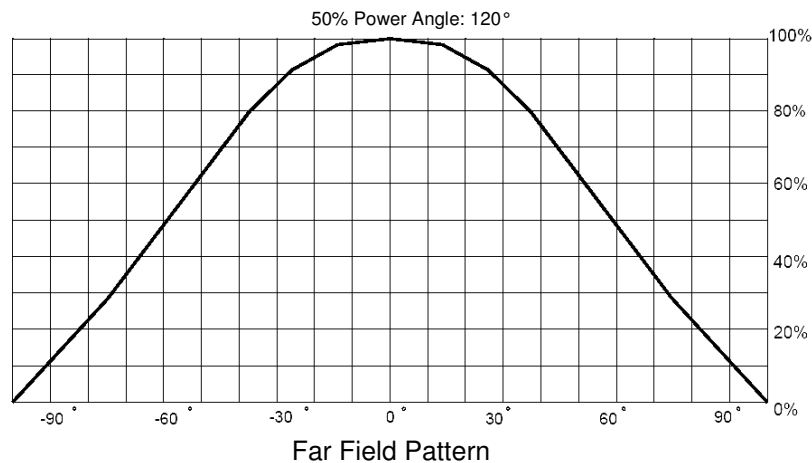

CIE Graph

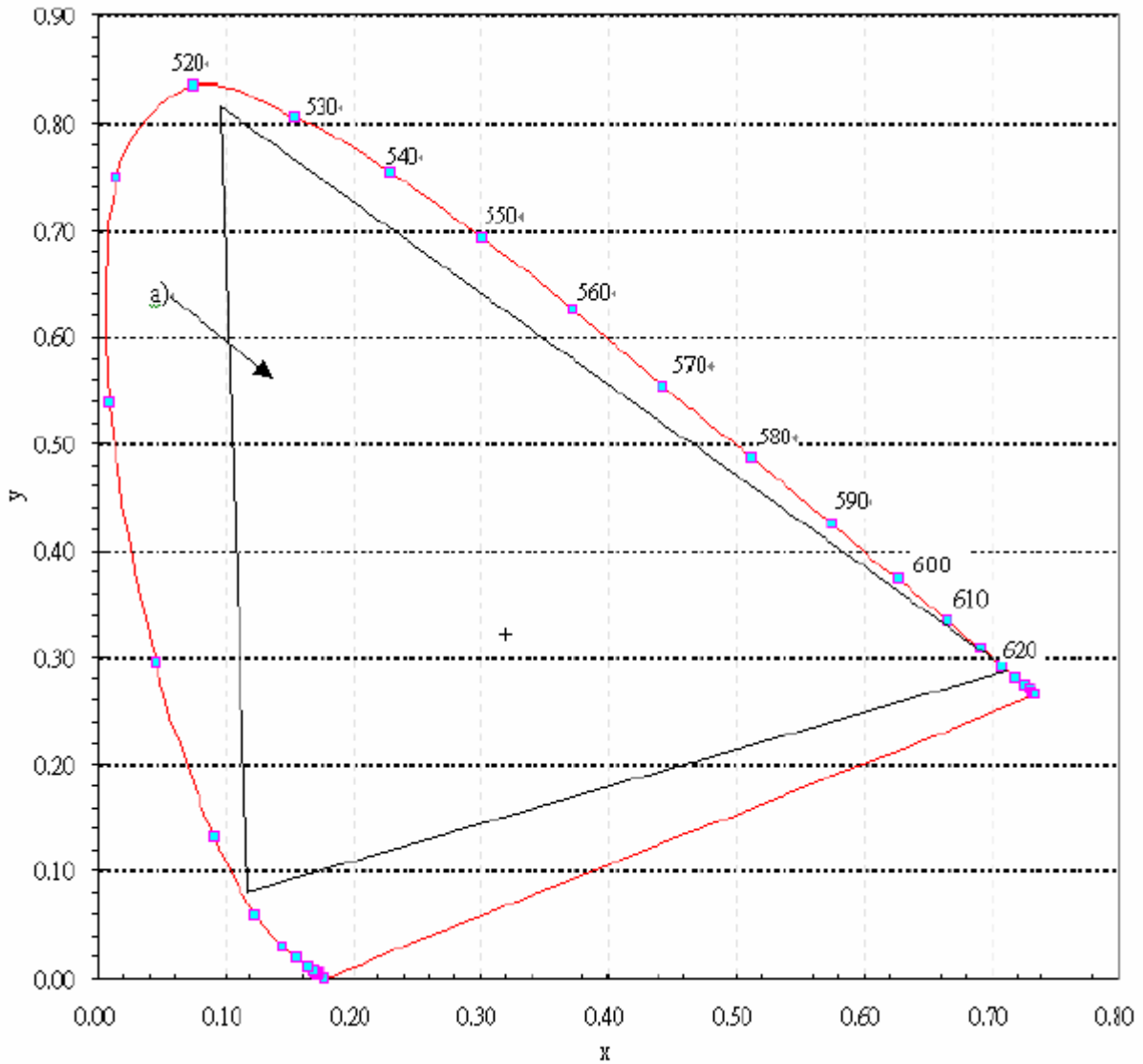

The color coordinates of the mixed light can be expected within the area of the color triangle marked a).
The achromatic point ($x = 0.33, y = 0.33$) is marked "+".

Full-Color PLCC4 LED OVSARGB3R8

Reel Dimensions (7 Inch)

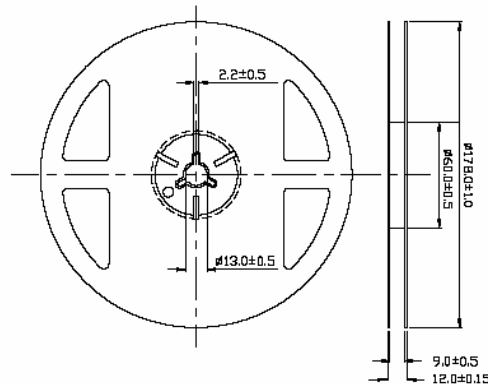

Carrier Tape Dimensions: Loaded Quantity 2000 PCS per Reel

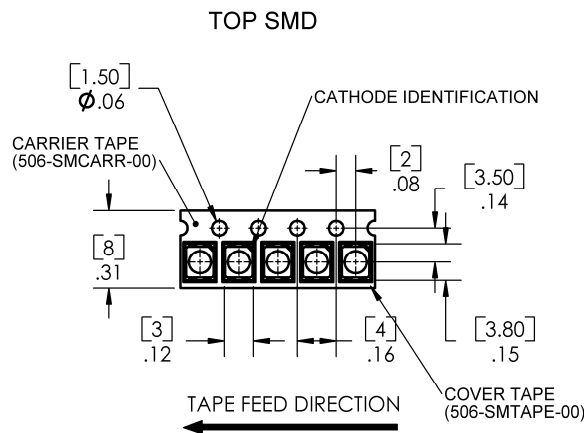

Moisture Resistant Packaging

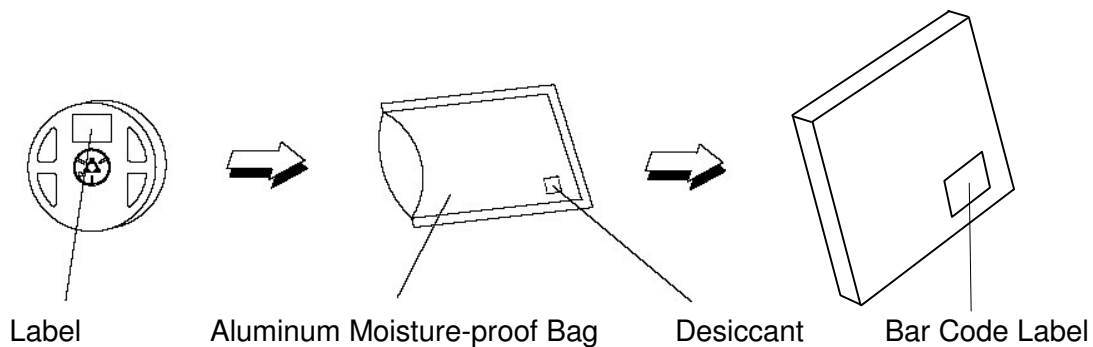

Issue	Change Description	Approval	Date
1.0	Initial Release	J. Haynie	6/30/05