

# φ5.0(T-1 3/4) Circular Type High Brightness Type <Viewing Angle 2θ1/2 : 40°>



## SLA-560 Series

Emitting Color	Blue				Green	Green(Yellowish Green)	Red	
Material	InGaN on SiC					GaP	GaAlAs on GaAs	
Emitting Surface Dimension(mm)								
Part No.	SLA560BC4T	SLA560BC7T	SLA560BCT	SLA560BD2T	SLA560EC4T	SLA560ECT	SLA-560MT	SLA-560LT

Note) "-" will be taken out for emitting color B/E series.

### Absolute Maximum Ratings (Ta=25°C)

Part No.	Emitting color	Power dissipation P <sub>D</sub> (mW)	Forward current I <sub>F</sub> (mA)	Peak forward current I <sub>FP</sub> (mA)	Reverse voltage V <sub>R</sub> (V)	Operating temperature T <sub>opr</sub> (°C)	Storage temperature T <sub>stg</sub> (°C)
SLA560BC4T	Blue	120	30	100 *1	5	-20 to +80	-30 to +100
SLA560BC7T		105	25				
SLA560BCT							
SLA560BD2T							
SLA560EC4T	Green	120	30				
SLA560ECT							
SLA-560MT	Green (Yellowish Green)	75	25	60 *2	4	-25 to +85	
SLA-560LT	Red	100	50	75 *2			

\*1:Duty ≤ 1/ 10, 1kHz

\*2:Duty ≤ 1/ 5, pulse width ≤ 1ms.

### Dimensions (Unit:mm)

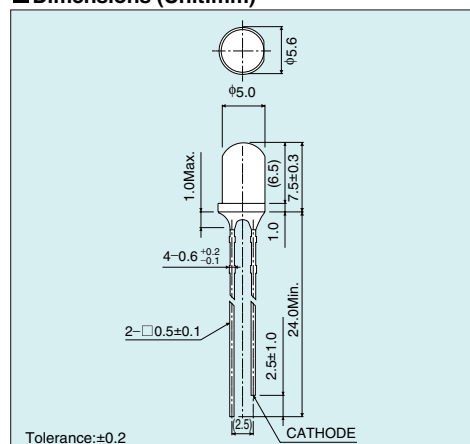

### Electrical Optical Characteristics (Ta=25°C)

Part No.	Resin Color	Forward voltage V <sub>F</sub>		Reverse current I <sub>R</sub>		Light wavelength			Brightness I <sub>v</sub>			
		Typ. (V)	I <sub>F</sub> (mA)	Max. (μA)	V <sub>R</sub> (V)	Peak λ <sub>p</sub> (nm)	Half-wave Δλ (nm)	I <sub>F</sub> (mA)	Min. (mcd)	Typ. (mcd)	I <sub>F</sub> (mA)	
SLA560BC4T	Transparent Colorless	3.2	20	100	5	468	26	20	200	470	20	
SLA560BC7T		330							680			
SLA560BCT		200							600			
SLA560BD2T		1000							2200			
SLA560EC4T		523							36	610		1500
SLA560ECT		518							35			2000
SLA-560MT	2.3		10	4	563	40		42	100			
SLA-560LT	1.75		100		660	25						

### Directivity (Typ.)

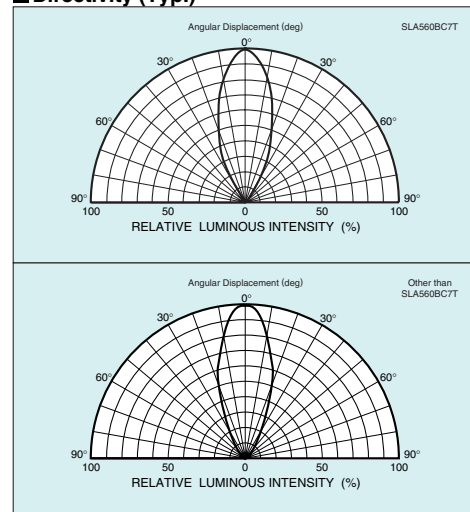

### Recommended Pad Layout

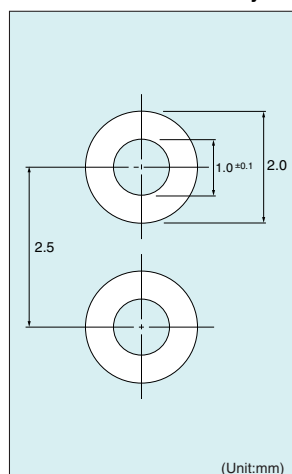

### Packaging Specifications (Unit:mm)

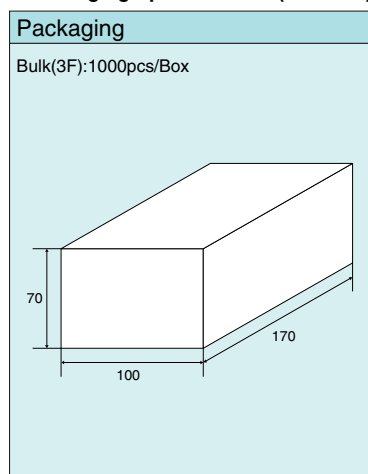

Note) The design and specifications are subject to change without prior notice. Before ordering or using, please check the latest technical specifications.

Rev.D

## Electrical Characteristic Curves

### Forward Current - Forward Voltage

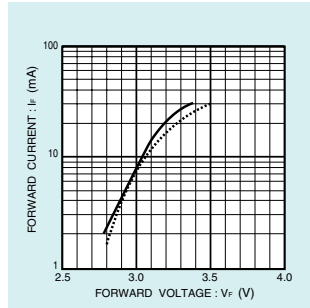

..... SLA560BCT  
 SLA560ECT  
 — SLA560BC4T  
 SLA560EC4T

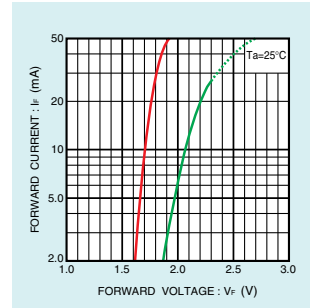

— SLA-560MT  
 — SLA-560LT

### Relative Luminous Intensity - Case Temperature

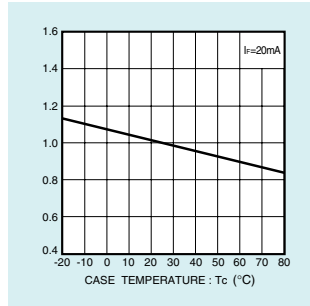

— SLA560BCT  
 SLA560ECT  
 SLA560BC4T  
 SLA560EC4T

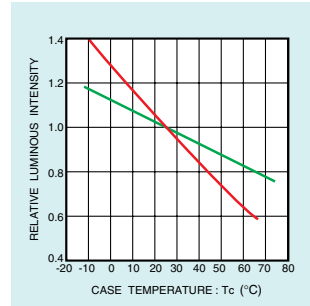

— SLA-560MT  
 — SLA-560LT

### Relative Luminous Intensity - Forward Current

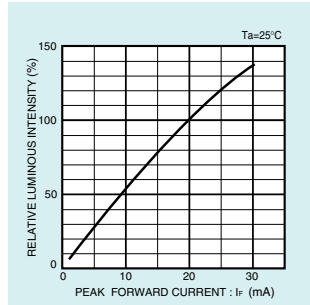

— SLA560BCT  
 SLA560ECT  
 SLA560BC4T  
 SLA560EC4T

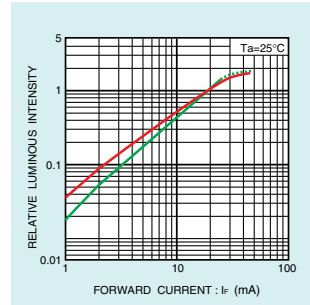

— SLA-560MT  
 — SLA-560LT

### Ratio of Maximum Tolerable Peak Current - Pulse Duration

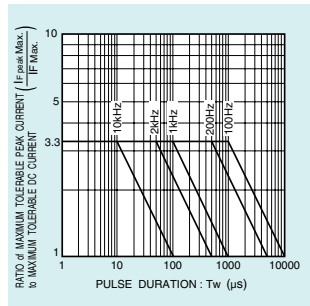

— SLA560BCT  
 SLA560ECT  
 SLA560BC4T  
 SLA560EC4T

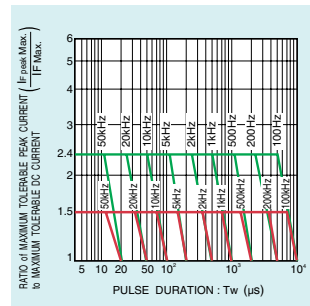

— SLA-560MT  
 — SLA-560LT

### Derating

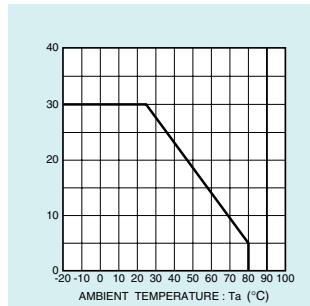

— SLA560BCT  
 SLA560ECT  
 SLA560BC4T  
 SLA560EC4T

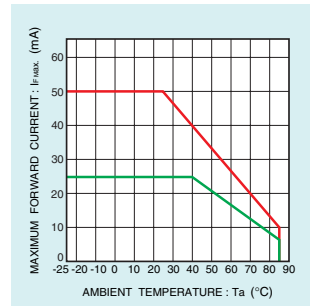

— SLA-560MT  
 — SLA-560LT

\*Note : Characteristics data of SLA560BC7T & SLA560BD2T are under preparation.

### Notes

- No technical content pages of this document may be reproduced in any form or transmitted by any means without prior permission of ROHM CO.,LTD.
- The contents described herein are subject to change without notice. The specifications for the product described in this document are for reference only. Upon actual use, therefore, please request that specifications to be separately delivered.
- Application circuit diagrams and circuit constants contained herein are shown as examples of standard use and operation. Please pay careful attention to the peripheral conditions when designing circuits and deciding upon circuit constants in the set.
- Any data, including, but not limited to application circuit diagrams information, described herein are intended only as illustrations of such devices and not as the specifications for such devices. ROHM CO.,LTD. disclaims any warranty that any use of such devices shall be free from infringement of any third party's intellectual property rights or other proprietary rights, and further, assumes no liability of whatsoever nature in the event of any such infringement, or arising from or connected with or related to the use of such devices.
- Upon the sale of any such devices, other than for buyer's right to use such devices itself, resell or otherwise dispose of the same, no express or implied right or license to practice or commercially exploit any intellectual property rights or other proprietary rights owned or controlled by
- ROHM CO., LTD. is granted to any such buyer.
- Products listed in this document are no antiradiation design.

The products listed in this document are designed to be used with ordinary electronic equipment or devices (such as audio visual equipment, office-automation equipment, communications devices, electrical appliances and electronic toys).

Should you intend to use these products with equipment or devices which require an extremely high level of reliability and the malfunction of which would directly endanger human life (such as medical instruments, transportation equipment, aerospace machinery, nuclear-reactor controllers, fuel controllers and other safety devices), please be sure to consult with our sales representative in advance.

It is our top priority to supply products with the utmost quality and reliability. However, there is always a chance of failure due to unexpected factors. Therefore, please take into account the derating characteristics and allow for sufficient safety features, such as extra margin, anti-flammability, and fail-safe measures when designing in order to prevent possible accidents that may result in bodily harm or fire caused by component failure. ROHM cannot be held responsible for any damages arising from the use of the products under conditions out of the range of the specifications or due to non-compliance with the NOTES specified in this catalog.

Thank you for your accessing to ROHM product informations.

More detail product informations and catalogs are available, please contact your nearest sales office.

**ROHM** Customer Support System

THE AMERICAS / EUROPE / ASIA / JAPAN

[www.rohm.com](http://www.rohm.com)

Contact us : [webmaster@rohm.co.jp](mailto:webmaster@rohm.co.jp)