

UNCONTROLLED DOCUMENT

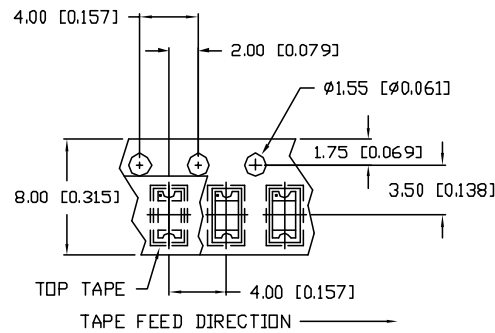

\*UNLESS OTHERWISE SPECIFIED TOLERANCES PER DECIMAL PRECISION ARE: X=±1 (±0.039), XX=±0.5 (±0.020), XXX=±0.25 (±0.010), XXXX=±0.127 (±0.005).

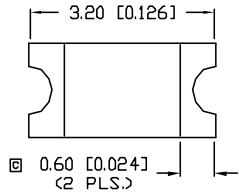
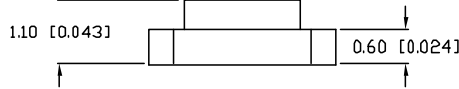
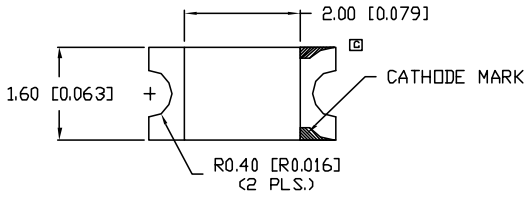
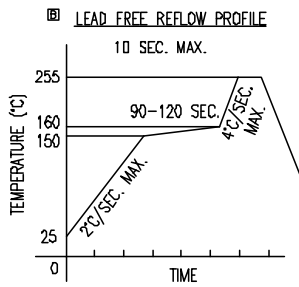
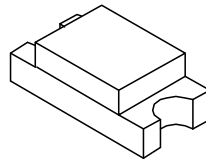

TOTAL TIME ABOVE 220°C IS 60 SECONDS MAX.

RECOMMENDED SOLDER PAD LAYOUT

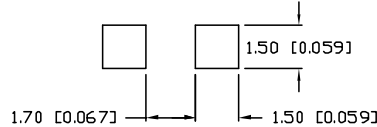

PART NUMBER		REV.
SML-LX1206SUGC-TR		C
REV.	E.C.N. NUMBER AND REVISION COMMENTS	DATE
A	E.C.N. #10967.	3.14.03
B	E.C.N. #11148.	6.5.05
C	E.C.N. #11466.	12.28.07

ELECTRO-OPTICAL CHARACTERISTICS $T_A=25^\circ\text{C}$ $I_f=20\text{mA}$					
PARAMETER	MIN	TYP	MAX	UNITS	TEST COND
PEAK WAVELENGTH		574		nm	
FORWARD VOLTAGE		2.2	2.6	$V_f$	
REVERSE VOLTAGE	5.0			$V_r$	$I_f=100\mu\text{A}$
AXIAL INTENSITY		45		mcad	$I_f=20\text{mA}$
VIEWING ANGLE		140		2x theta	
EMITTED COLOR:	GREEN				
EPOXY LENS FINISH:	WATER CLEAR				

LIMITS OF SAFE OPERATION AT 25°C		
PARAMETER	MAX	UNITS
PEAK FORWARD CURRENT*	160	mA
STEADY CURRENT	25	mA
POWER DISSIPATION	100	mW
DERATE FROM 25°C	-1.2	mW/°C
OPERATING TEMP.	-30 TO +85	°C
STORAGE TEMP.	-40 TO +85	°C

NOTES:

1. THE POLARITY MARK IS ORIENTED TOWARDS THE TAPE SPROCKET HOLE.

CAUTION: MOISTURE SENSITIVE DEVICE  
PER JEDEC LEVEL 4 STANDARDS

UNCONTROLLED DOCUMENT

REV.	PART NUMBER
C	SML-LX1206SUGC-TR

3.2mm x 1.6mm PCB SURFACE MOUNT LED,  
574nm SUPER ULTRA GREEN LED,  
WATER CLEAR LENS, TAPE AND REEL

CONFIDENTIAL INFORMATION  
THE INFORMATION CONTAINED IN THIS DOCUMENT IS THE PROPERTY OF LUMEX INC. EXCEPT AS SPECIFICALLY AUTHORIZED IN WRITING BY LUMEX INC., THE HOLDER OF THIS DOCUMENT SHALL KEEP ALL INFORMATION CONTAINED HEREIN CONFIDENTIAL AND SHALL PROTECT SAME IN WHOLE OR IN PART FROM DISCLOSURE AND DISSEMINATION TO ALL THIRD PARTIES.

RELIABILITY NOTE  
OUR MANY YEARS OF EXPERIENCE DATA ACCUMULATION INDICATE THAT SOLDER HEAT IS A MAJOR CAUSE OF EARLY AND FUTURE FAILURE. PLEASE PAY ATTENTION TO YOUR SOLDERING PROCESS.



290 E. HELEN ROAD  
PALATINE, IL 60067-6976  
PHONE: +1.847.359.2790  
US WEB: www.lumex.com  
TW WEB: www.lumex.com.tw

DRAWN BY:	CHECKED BY:	APPROVED BY:	DATE:
BC			1.8.01
			PAGE: 1 OF 1
			SCALE: N/A