

ASMT-Rx45-xxxxx

0.45mm Leadframe-Based Surface Mount ChipLED



Data Sheet



Lead (Pb) Free
RoHS 6 fully
compliant

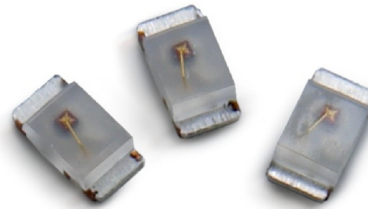

Description

Avago's ultra-thin ASMT-Rx45 ChipLEDs were developed based on the industrial standard ChipLED 0603 platform which requires less board space. These ChipLEDs provide a wide viewing angle of 130 degrees to improve visibility in bright sunlight.

In addition to the high-brightness and compact size, Avago's ASMT-Rx45 ChipLEDs provide two significant advantages in the production environment: They can be easily soldered using IR solder reflow process, and the package is qualified to a Joint Electronic Device Engineering Council (JEDEC) moisture sensitive level (MSL) rating of 2a. For manufacturers, this rating means that these ChipLEDs can be kept in the open air (30 degrees C, 60 percent relative humidity) for up to four weeks after being removed from its sealed package without the need to remove absorbed moisture.

Avago's ultra-thin Leadframe ChipLED available in Red, Orange, Yellow Green and Amber colors, the ASMT-Rx45 series is ideal for use by lighting designers developing backlighting for dashboards and entertainment consoles in automobiles, backlighting of industrial switches and buttons, and small pixel indoor signs.

Features

- Industrial 0603 platform – 1.6 x 0.8 x 0.45mm
- Automotive qualified
- Super wide 145 deg viewing angle
- JEDEC MSL 2a.
- Robust Operating Temperature from - 40 to +100°C
- Junction Temperature $T_j = 110^\circ\text{C}$
- Available in 4000 parts per reel
- RoHS & IR Reflow compatible

Applications

- Interior Automotive
 - Navigation backlighting
 - Audio panel backlighting
 - Push Button backlighting
- Office Automation, home appliances, industrial equipment
 - Front panel backlighting
 - Push Button backlighting
 - LCD backlighting
 - Switches backlighting
 - Navigation backlighting

CAUTION: ASMT-Rx45 LEDs are Class 1C ESD sensitive per JESD22-A114C.01. Please observe appropriate precautions during handling and processing. Refer to Application Note AN-1142 for additional details.

Package Dimensions

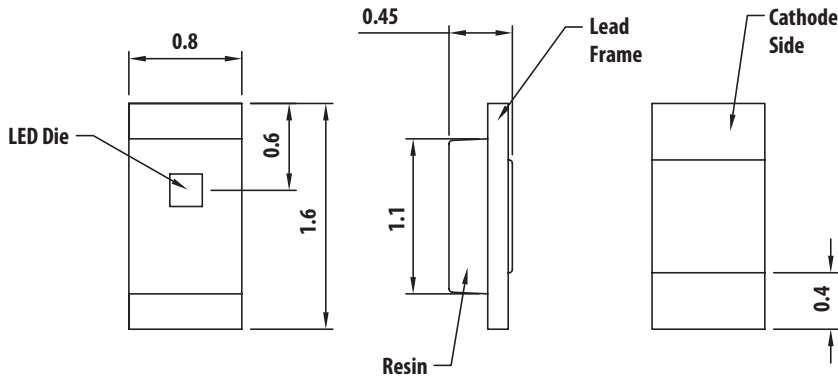

NOTES:

1. All Dimensions in millimeters.
2. Tolerance is ± 0.1 mm unless otherwise specified.

Device Selection Guide

Part Number	Min. I_v (mcd)	Typ. I_v (mcd)	Test Current (mA)	Colors	Dice Technology	Package Description
ASMT-RR45-AQ902	90.0	120.0	20	Red	AllnGaP	Untinted, Diffused
ASMT-RJ45-AQ502	71.5	130.0	20	Orange	AllnGaP	Untinted, Diffused
ASMT-RF45-AN002	28.0	60.0	20	Yellow Green	AllnGaP	Untinted, Diffused
ASMT-RA45-AP932	57.0	90.0	20	Amber	AllnGaP	Untinted, Diffused

Notes:

1. The luminous intensity I_v is measured at the peak of the spatial radiation pattern which may not be aligned with the mechanical axis of the LED package.
2. Tolerance: $\pm 15\%$

Part Numbering System

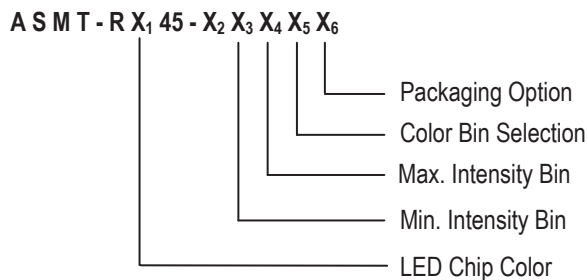

Absolute Maximum Ratings at $T_A = 25^\circ\text{C}$

Parameter	ASMT-Rx45	Units
DC Forward Current ^[1]	20	mA
Power Dissipation	48	mW
Reverse Voltage ($I_R = 100\mu\text{A}$)	5	V
LED Junction Temperature	110	$^\circ\text{C}$
Operating Temperature Range	-40 to +100	$^\circ\text{C}$
Storage Temperature Range	-40 to +100	$^\circ\text{C}$

Notes:

1. Applies when single LED is lit up.

Electrical Characteristics at $T_A = 25^\circ\text{C}$

Part Number	Forward Voltage, V_F (Volts) ^[1] @ $I_F = 20\text{mA}$			Reverse Breakdown V_R (Volts) @ $I_R = 100\mu\text{A}$	Thermal Resistance $R\theta_{J-PIN}$ ($^\circ\text{C}/\text{W}$)
	Min.	Typ.	Max.	Min.	Typical
ASMT-RR45-AQ902	1.6	2.0	2.4	5	246
ASMT-RJ45-AQ502	1.6	2.0	2.4	5	246
ASMT-RF45-AN002	1.6	2.0	2.4	5	246
ASMT-RA45-AP932	1.6	2.0	2.4	5	246

Notes:

1. V_F Tolerance: $\pm 0.1\text{V}$

Optical Characteristics at $T_A = 25^\circ\text{C}$

Part Number	Color	Peak Wavelength λ_{peak} (nm)	Dominant Wavelength λ_d ^[2] (nm)	Viewing Angle $2\theta_{1/2}$ ^[3] (Degrees)
		Typical	Typical	Typical
ASMT-RR45-AQ902	Red	636	622	145
ASMT-RJ45-AQ502	Orange	612	605	145
ASMT-RF45-AN002	Yellow Green	574	573	145
ASMT-RA45-AP932	Amber	593	591	145

Notes:

1. The dominant wavelength, λ_d , is derived from the CIE Chromaticity Diagram and represents the perceived color of the device.
2. $\theta_{1/2}$ is the off-axis angle where the luminous intensity is $1/2$ the peak intensity.

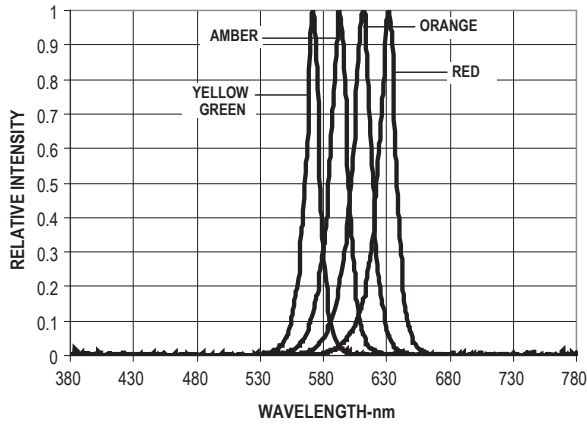

Figure 1. Relative intensity vs. wavelength.

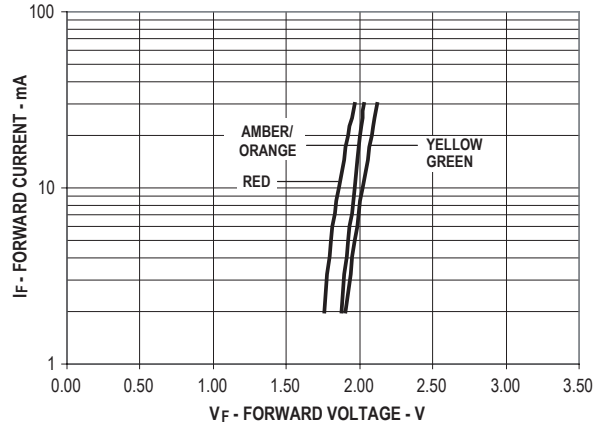

Figure 2. Forward current vs. forward voltage.

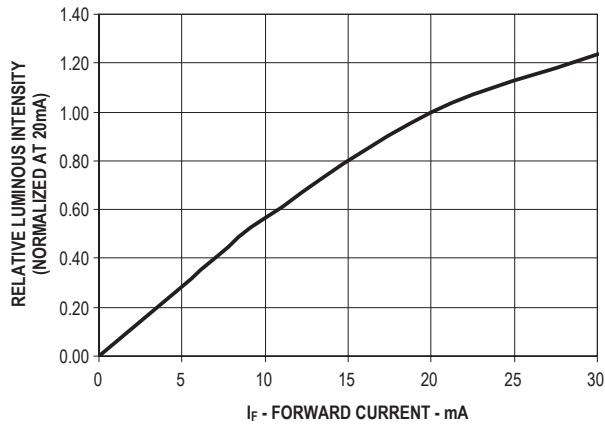

Figure 3. Luminous intensity vs. forward current.

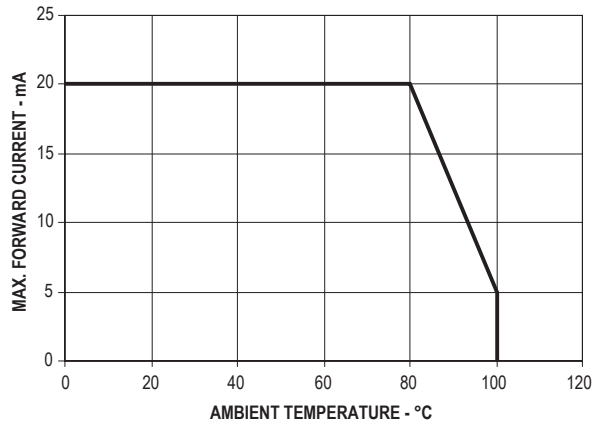

Figure 4. Maximum forward current vs. ambient temperature.
Derated based on $T_{JMAX} = 110^{\circ}C$, $R\theta_{JA} = 465^{\circ}C/W$

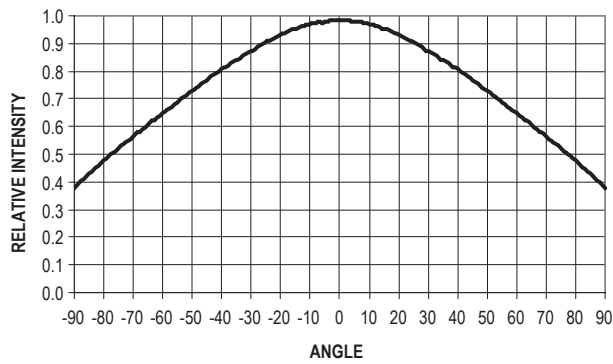

Figure 5. Radiation pattern.

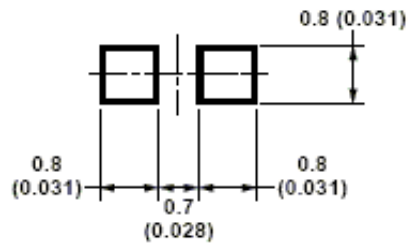

Figure 6. Recommended soldering land pattern.

Notes:

1. All dimensions are in millimeters (inches).
2. Tolerance is $\pm 0.1\text{mm}$ ($\pm 0.004\text{in.}$) unless otherwise specified.

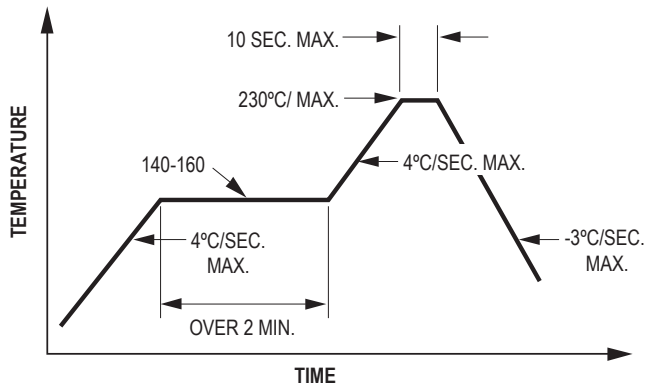

Figure 7a. Recommended reflow soldering profile.

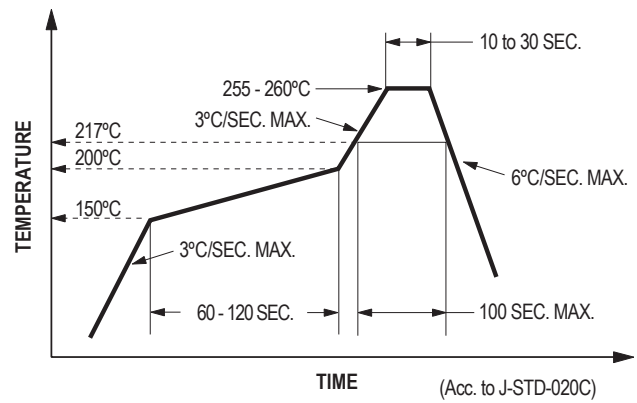

Figure 7b. Recommended Pb-free reflow soldering profile.

Notes:

For detail information on reflow soldering of Avago surface mount LEDs, do refer to Avago Application Note AN 1060 Surface Mounting SMT LED Indicator Components.

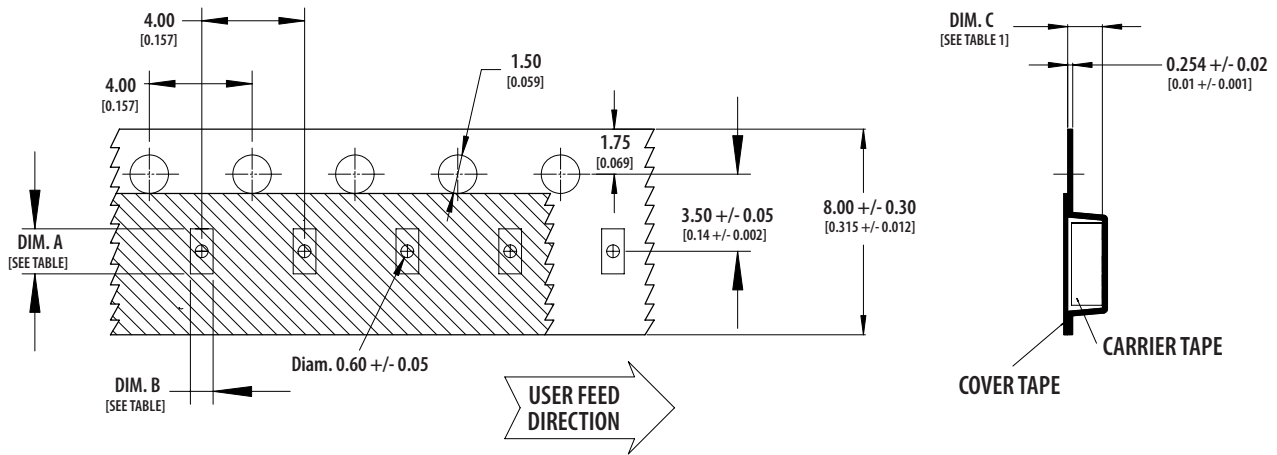

Figure 8. Tape Dimensions.

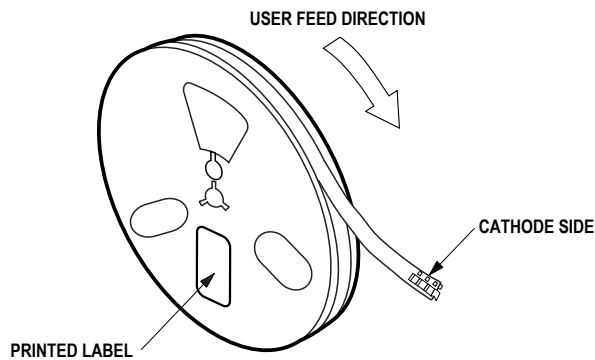

Figure 9. Reeling Orientation.

Intensity Bin Select (X_3X_4)

Individual reel will contain parts from one half bin only

X_3	Min I_V Bin
X_4	
0	Full Distribution
2	2 half bins starting from X_31
3	3 half bins starting from X_31
4	4 half bins starting from X_31
5	5 half bins starting from X_31
6	2 half bins starting from X_32
7	3 half bins starting from X_32
8	4 half bins starting from X_32
9	5 half bins starting from X_32

Light Intensity (I_V) Bin Limits

Bin ID	Intensity (mcd)	
	Min.	Max.
A1	0.11	0.14
A2	0.14	0.18
B1	0.18	0.23
B2	0.23	0.29
C1	0.29	0.36
C2	0.36	0.45
D1	0.45	0.57
D2	0.57	0.72
E1	0.72	0.90
E2	0.90	1.10
F1	1.10	1.41
F2	1.41	1.80
G1	1.80	2.24
G2	2.24	2.80
H1	2.80	3.55
H2	3.55	4.50
J1	4.50	5.70
J2	5.70	7.20
K1	7.20	9.00
K2	9.00	11.20
L1	11.20	14.20
L2	14.20	18.00
M1	18.00	22.50
M2	22.50	28.00
N1	28.00	36.00
N2	36.00	45.00
P1	45.00	57.00
P2	57.00	71.50
Q1	71.50	90.00
Q2	90.00	113.00
R1	113.00	142.00
R2	142.00	180.00
S1	180.00	227.00
S2	227.00	285.00

Tolerance: $\pm 15\%$

Color Bin Select (X₅)

Individual reel will contain parts from one full bin only.

X ₅	
0	Full Distribution
Z	A and B only
Y	B and C only
W	C and D only
V	D and E only
U	E and F only
T	F and G only
S	G and H only
Q	A, B and C only
P	B, C and D only
N	C, D and E only
M	D, E and F only
L	E, F and G only
K	F, G and H only
J	Special Color Bin
1	A, B, C and D only
2	E, F, G and H only
3	B, C, D and E only
4	C, D, E and F only
5	A, B, C, D and E only
6	B, C, D, E, and F only

Packaging Option (X₆)

Option	Test Current	Package Type	Reel Size
2	20 mA	Top Mount	7 Inch
H	2 mA	Top Mount	7 Inch
K	5 mA	Top Mount	7 Inch

Forward Voltage (V_F) Bin Limits

Bin ID	Forward Voltage (V)	
	Minimum	Maximum
1	1.60	1.80
2	1.80	2.00
3	2.00	2.20
4	2.20	2.40

Tolerance: ±0.1V

Color Bin Limits

Yellow Green Color Bin

Bin ID	Dominant Wavelength (nm)	
	Min.	Max.
E	564.5	567.5
F	567.5	570.5
G	570.5	573.5
H	573.5	576.5

Yellow/Amber Color Bin

Bin ID	Dominant Wavelength (nm)	
	Min.	Max.
A	582.0	584.5
B	584.5	587.0
C	587.0	589.5
D	589.5	592.0
E	592.0	594.5
F	594.5	597.0

Orange Color Bin

Bin ID	Dominant Wavelength (nm)	
	Min	Max
A	597.0	600.0
B	600.0	603.0
C	603.0	606.0
D	606.0	609.0
E	609.0	612.0

Red Color Bin

Bin ID	Dominant Wavelength (nm)	
	Min.	Max.
Full Distribution	620.0	635.0

Tolerance: ±1nm

Moisture Sensitivity

This product is qualified as Moisture Sensitive Level 2a per Jedec J-STD-020. Precautions when handling this moisture sensitive product is important to ensure the reliability of the product. Do refer to Avago Application Note AN5305 Handling of Moisture Sensitive Surface Mount Devices for details.

A. Storage before use

- Unopen moisture barrier bag (MBB) can be stored at <40°C/90%RH for 12 months. If the actual shelf life has exceeded 12 months and the HIC indicates that baking is not required, then it is safe to reflow the LEDs per the original MSL rating.
- It is not recommended to open the MBB prior to assembly (e.g. for IQC).

B. Control after opening the MBB

- The humidity indicator card (HIC) shall be read immediately upon opening of MBB.
- The LEDs must be kept at <30°C/60%RH at all time and all high temperature related process including soldering, curing or rework need to be completed within 672 hours.

C. Control for unfinished reel

- For any unuse LEDs, they need to be stored in sealed MBB with desiccant or desiccator at <5%RH.

D. Control of assembled boards

- If the PCB soldered with the LEDs is to be subjected to other high temperature processes, the PCB need to be stored in sealed MBB with desiccant or desiccator at <5%RH to ensure no LEDs have exceeded their floor life of 672 hours.

E. Baking is required if:

- “10%” or “15%” HIC indicator turns pink.
- The LEDs are exposed to condition of >30°C/60% RH at any time.
- The LEDs floor life exceeded 672 hours.

Recommended baking condition: 60±5°C for 20 hours.

For product information and a complete list of distributors, please go to our web site: www.avagotech.com

Avago, Avago Technologies, and the A logo are trademarks of Avago Technologies in the United States and other countries. Data subject to change. Copyright © 2005-2008 Avago Technologies. All rights reserved. AV02-0378EN - December 23, 2008

