

High Intensity LED, Ø 5 mm Untinted Non-Diffused

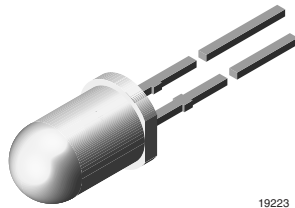

19223

DESCRIPTION

The TLH.51.. series is a clear, non diffused 5 mm LED for outdoor application.

These clear lamps utilize the highly developed technologies like AlInGaP and GaP.

The lens and the viewing angle is optimized to achieve best performance of light output and visibility.

FEATURES

- Untinted non diffused lens
- Choice of four colors
- TLH.5100 for cost effective design
- Medium viewing angle
- Compliant to RoHS directive 2002/95/EC and in accordance to WEEE 2002/96/EC

RoHS
COMPLIANT

APPLICATIONS

- Outdoor LED panels
- Central high mounted stop lights (CHMSL) for motor vehicles
- Instrumentation and front panel indicators
- Light guide design
- Traffic signals

PRODUCT GROUP AND PACKAGE DATA

- Product group: LED
- Package: 5 mm
- Product series: standard
- Angle of half intensity: $\pm 9^\circ$

PARTS TABLE

PART	COLOR, LUMINOUS INTENSITY	TECHNOLOGY
TLHK5100	Red, $I_V > 320$ mcd	AllnGaP on GaAs
TLHE5100	Yellow, $I_V > 750$ mcd	AllnGaP on GaAs
TLHG5100	Green, $I_V > 240$ mcd	GaP on GaP

ABSOLUTE MAXIMUM RATINGS ¹⁾ TLHK51.. , TLHE51.. , TLHG51..

PARAMETER	TEST CONDITION	SYMBOL	VALUE	UNIT
Reverse voltage		V_R	6	V
DC Forward current	$T_{amb} \leq 65^\circ\text{C}$	I_F	30	mA
Surge forward current	$t_p \leq 10 \mu\text{s}$	I_{FSM}	1	A
Power dissipation	$T_{amb} \leq 65^\circ\text{C}$	P_V	100	mW
Junction temperature		T_J	100	$^\circ\text{C}$
Operating temperature range		T_{amb}	- 40 to + 100	$^\circ\text{C}$
Storage temperature range		T_{stg}	- 55 to + 100	$^\circ\text{C}$
Soldering temperature	$t \leq 5$ s, 2 mm from body	T_{sd}	260	$^\circ\text{C}$
Thermal resistance junction/ ambient		R_{thJA}	350	K/W

Note:

¹⁾ $T_{amb} = 25^\circ\text{C}$, unless otherwise specified

OPTICAL AND ELECTRICAL CHARACTERISTICS ¹⁾ TLHK510., RED						
PARAMETER	TEST CONDITION	SYMBOL	MIN.	TYP.	MAX.	UNIT
Luminous intensity ²⁾	$I_F = 20 \text{ mA}$	I_V	320			mcd
Dominant wavelength	$I_F = 10 \text{ mA}$	λ_d	626	630	639	nm
Peak wavelength	$I_F = 10 \text{ mA}$	λ_p		643		nm
Angle of half intensity	$I_F = 10 \text{ mA}$	φ		± 9		deg
Forward voltage	$I_F = 20 \text{ mA}$	V_F		1.9	2.6	V
Reverse voltage	$I_R = 10 \mu\text{A}$	V_R	5			V
Junction capacitance	$V_R = 0, f = 1 \text{ MHz}$	C_j		15		pF

Notes:

¹⁾ $T_{amb} = 25 \text{ }^\circ\text{C}$, unless otherwise specified

²⁾ In one packing unit $I_{Vmin.}/I_{Vmax.} \leq 0.5$

OPTICAL AND ELECTRICAL CHARACTERISTICS ¹⁾ TLHE510., YELLOW						
PARAMETER	TEST CONDITION	SYMBOL	MIN.	TYP.	MAX.	UNIT
Luminous intensity ²⁾	$I_F = 20 \text{ mA}$	I_V	750			mcd
Dominant wavelength	$I_F = 10 \text{ mA}$	λ_d	581	588	594	nm
Peak wavelength	$I_F = 10 \text{ mA}$	λ_p		590		nm
Angle of half intensity	$I_F = 10 \text{ mA}$	φ		± 9		deg
Forward voltage	$I_F = 20 \text{ mA}$	V_F		2	2.6	V
Reverse voltage	$I_R = 10 \mu\text{A}$	V_R	5			V
Junction capacitance	$V_R = 0, f = 1 \text{ MHz}$	C_j		15		pF

Notes:

¹⁾ $T_{amb} = 25 \text{ }^\circ\text{C}$, unless otherwise specified

²⁾ In one packing unit $I_{Vmin.}/I_{Vmax.} \leq 0.5$

OPTICAL AND ELECTRICAL CHARACTERISTICS ¹⁾ TLHG510., GREEN						
PARAMETER	TEST CONDITION	SYMBOL	MIN.	TYP.	MAX.	UNIT
Luminous intensity ²⁾	$I_F = 20 \text{ mA}$	I_V	240			mcd
Dominant wavelength	$I_F = 10 \text{ mA}$	λ_d	562		575	nm
Peak wavelength	$I_F = 10 \text{ mA}$	λ_p		565		nm
Angle of half intensity	$I_F = 10 \text{ mA}$	φ		± 9		deg
Forward voltage	$I_F = 20 \text{ mA}$	V_F		2.4	3	V
Reverse voltage	$I_R = 10 \mu\text{A}$	V_R	6	15		V
Junction capacitance	$V_R = 0, f = 1 \text{ MHz}$	C_j		50		pF

Notes:

¹⁾ $T_{amb} = 25 \text{ }^\circ\text{C}$, unless otherwise specified

²⁾ In one packing unit $I_{Vmin.}/I_{Vmax.} \leq 0.5$

LUMINOUS INTENSITY CLASSIFICATION		
GROUP STANDARD	LUMINOUS INTENSITY (mcd)	
	MIN.	MAX.
Z	240	480
AA	320	640
BB	430	860
CC	575	1150
DD	750	1500
EE	1000	2000
FF	1350	2700
GG	1800	3600
HH	2400	4800
II	3200	6400
KK	4300	8600

Note:

Luminous intensity is tested at a current pulse duration of 25 ms and an accuracy of $\pm 11\%$.

The above type numbers represent the order groups which include only a few brightness groups. Only one group will be shipped on each bag (there will be no mixing of two groups on each bag).

In order to ensure availability, single brightness groups will not be orderable.

In a similar manner for colors where wavelength groups are measured and binned, single wavelength groups will be shipped in any one bag.

In order to ensure availability, single wavelength groups will not be orderable.

TYPICAL CHARACTERISTICS

$T_{amb} = 25\text{ }^{\circ}\text{C}$, unless otherwise specified

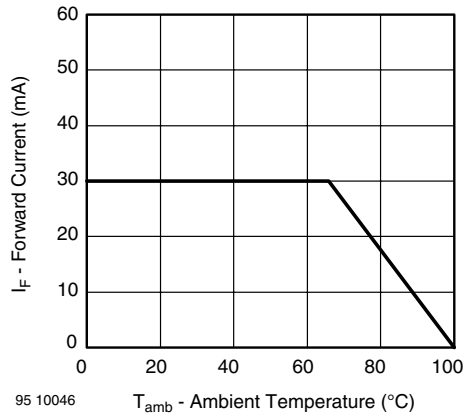

Figure 1. Forward Current vs. Ambient Temperature

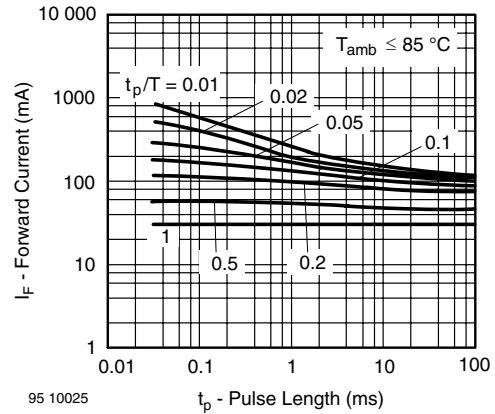

Figure 2. Forward Current vs. Pulse Length

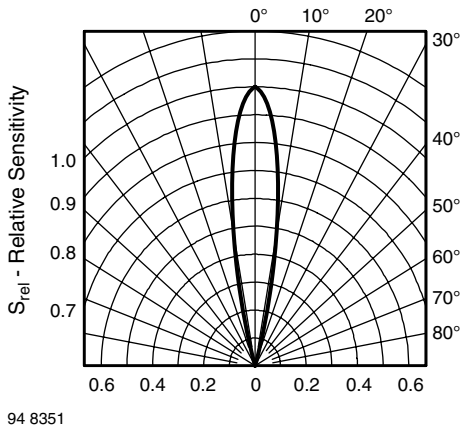

Figure 3. Relative Radiant Sensitivity vs. Angular Displacement

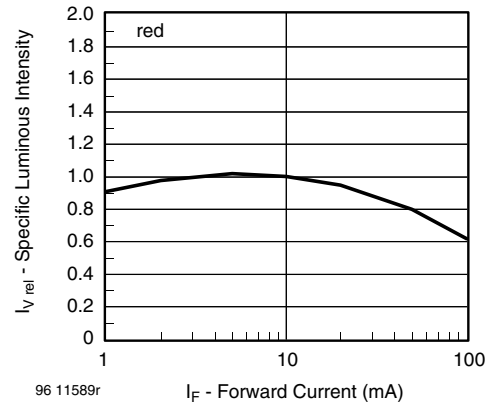

Figure 6. Specific Luminous Intensity vs. Forward Current

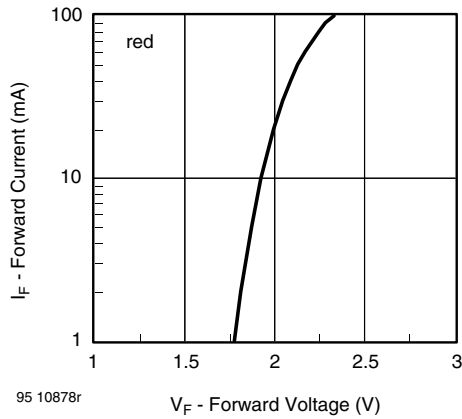

Figure 4. Forward Current vs. Forward Voltage

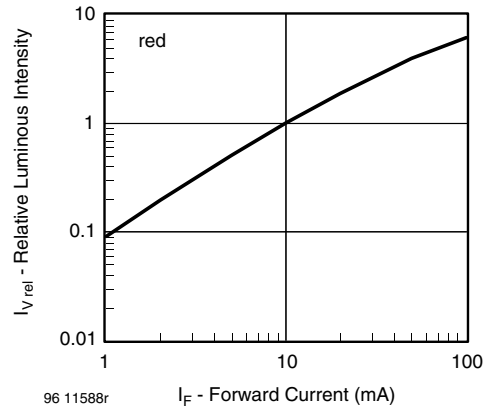

Figure 7. Relative Luminous Intensity vs. Forward Current

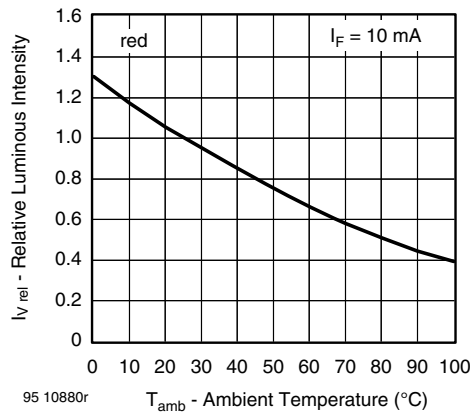

Figure 5. Rel. Luminous Intensity vs. Ambient Temperature

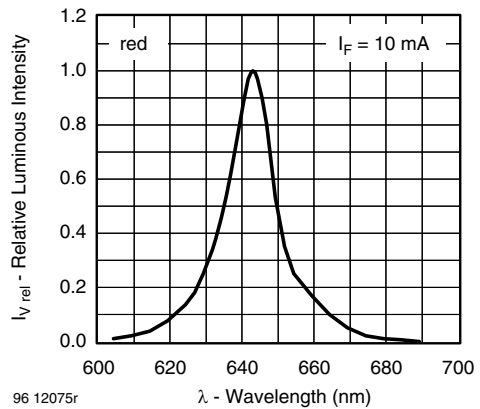

Figure 8. Relative Intensity vs. Wavelength

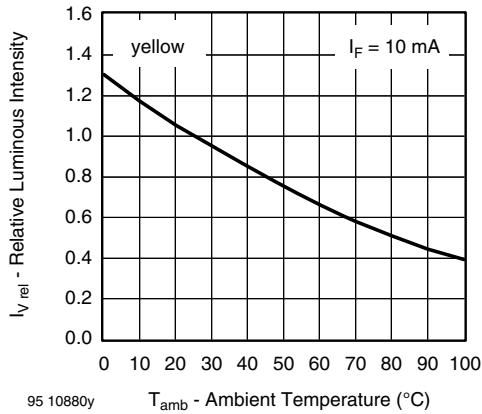

Figure 9. Rel. Luminous Intensity vs. Ambient Temperature

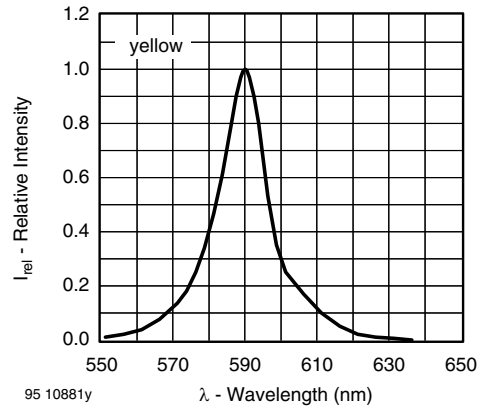

Figure 12. Relative Intensity vs. Wavelength

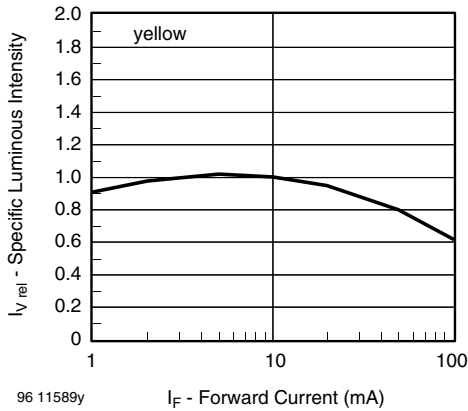

Figure 10. Specific Luminous Intensity vs. Forward Current

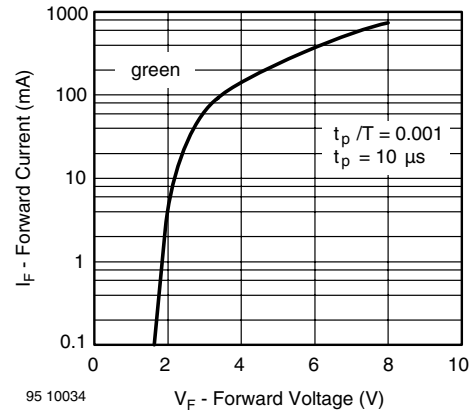

Figure 13. Forward Current vs. Forward Voltage

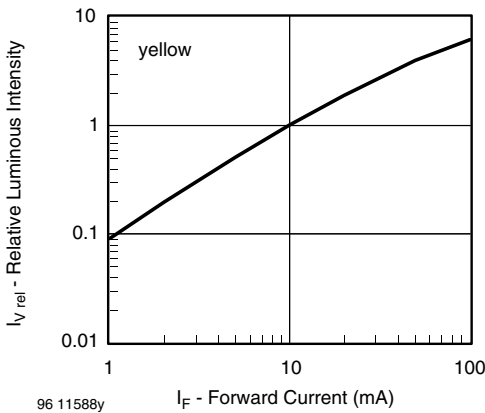

Figure 11. Relative Luminous Intensity vs. Forward Current

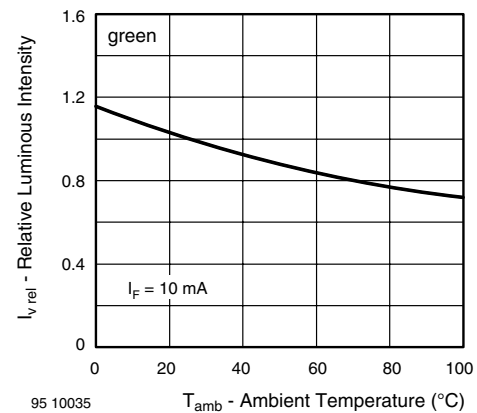

Figure 14. Rel. Luminous Intensity vs. Ambient Temperature

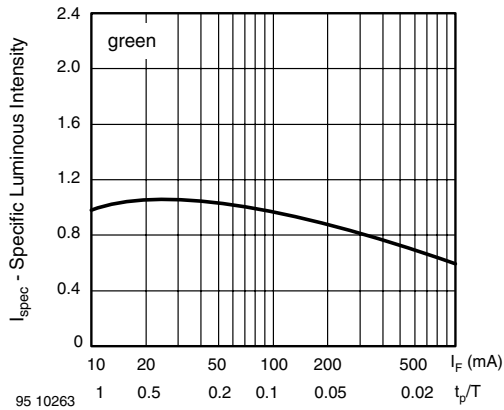

Figure 15. Specific Luminous Intensity vs. Forward Current

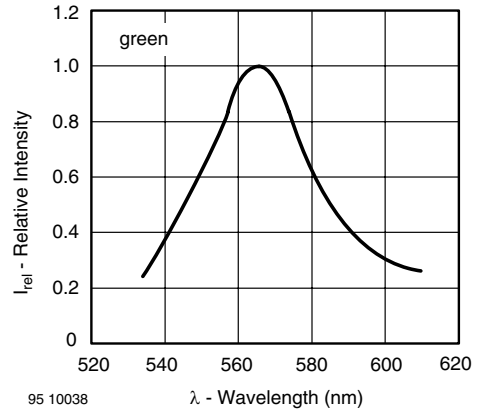

Figure 17. Relative Intensity vs. Wavelength

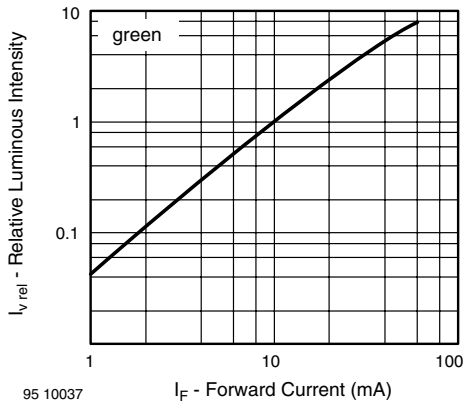
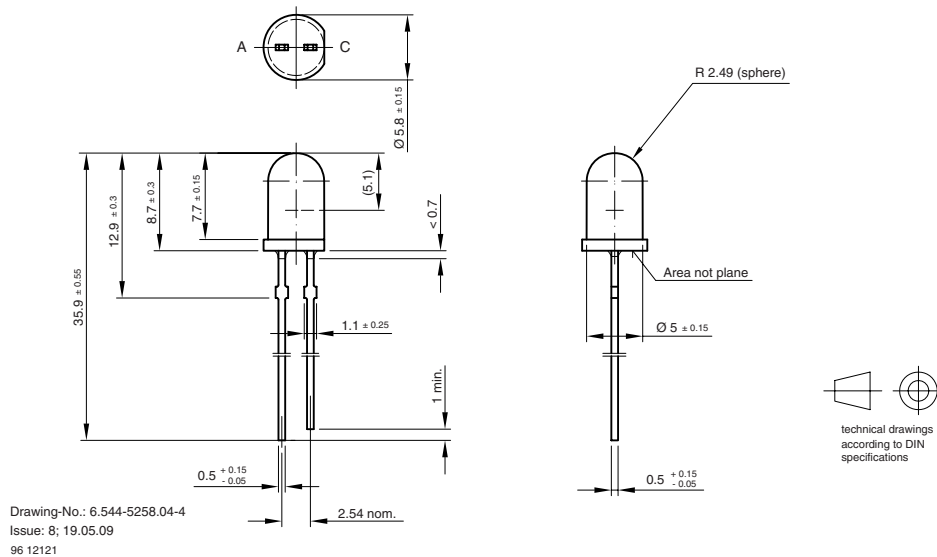

Figure 16. Relative Luminous Intensity vs. Forward Current

PACKAGE DIMENSIONS in millimeters





Disclaimer

ALL PRODUCT, PRODUCT SPECIFICATIONS AND DATA ARE SUBJECT TO CHANGE WITHOUT NOTICE TO IMPROVE RELIABILITY, FUNCTION OR DESIGN OR OTHERWISE.

Vishay Intertechnology, Inc., its affiliates, agents, and employees, and all persons acting on its or their behalf (collectively, "Vishay"), disclaim any and all liability for any errors, inaccuracies or incompleteness contained in any datasheet or in any other disclosure relating to any product.

Vishay makes no warranty, representation or guarantee regarding the suitability of the products for any particular purpose or the continuing production of any product. To the maximum extent permitted by applicable law, Vishay disclaims (i) any and all liability arising out of the application or use of any product, (ii) any and all liability, including without limitation special, consequential or incidental damages, and (iii) any and all implied warranties, including warranties of fitness for particular purpose, non-infringement and merchantability.

Statements regarding the suitability of products for certain types of applications are based on Vishay's knowledge of typical requirements that are often placed on Vishay products in generic applications. Such statements are not binding statements about the suitability of products for a particular application. It is the customer's responsibility to validate that a particular product with the properties described in the product specification is suitable for use in a particular application. Parameters provided in datasheets and/or specifications may vary in different applications and performance may vary over time. All operating parameters, including typical parameters, must be validated for each customer application by the customer's technical experts. Product specifications do not expand or otherwise modify Vishay's terms and conditions of purchase, including but not limited to the warranty expressed therein.

Except as expressly indicated in writing, Vishay products are not designed for use in medical, life-saving, or life-sustaining applications or for any other application in which the failure of the Vishay product could result in personal injury or death. Customers using or selling Vishay products not expressly indicated for use in such applications do so at their own risk and agree to fully indemnify and hold Vishay and its distributors harmless from and against any and all claims, liabilities, expenses and damages arising or resulting in connection with such use or sale, including attorneys fees, even if such claim alleges that Vishay or its distributor was negligent regarding the design or manufacture of the part. Please contact authorized Vishay personnel to obtain written terms and conditions regarding products designed for such applications.

No license, express or implied, by estoppel or otherwise, to any intellectual property rights is granted by this document or by any conduct of Vishay. Product names and markings noted herein may be trademarks of their respective owners.