

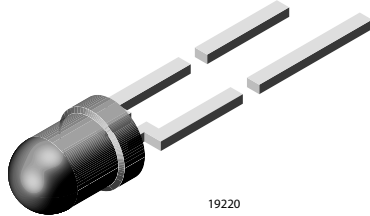

High Efficiency LED in Ø 3 mm Tinted Diffused Package



FEATURES

- Standard Ø 3 (T-1) package
Small mechanical tolerances
Suitable for DC and high peak current
Wide viewing angle
Luminous intensity categorized
Yellow and green color categorized
Compliant to RoHS Directive 2002/95/EC and in accordance to WEEE 2002/96/EC



DESCRIPTION

The TLH.44.. series was developed for standard applications like general indicating and lighting purposes. It is housed in a 3 mm tinted diffused plastic package. The wide viewing angle of these devices provides a high on-off contrast. Several selection types with different luminous intensities are offered. All LEDs are categorized in luminous intensity groups. The green and yellow LEDs are categorized additionally in wavelength groups. That allows users to assemble LEDs with uniform appearance.

APPLICATIONS

- Status lights
Off/on indicator
Background illumination
Readout lights
Maintenance lights
Legend light

PRODUCT GROUP AND PACKAGE DATA

- Product group: LED
Package: 3 mm
Product series: standard
Angle of half intensity: ± 30°

Table with 3 columns: PART, COLOR, LUMINOUS INTENSITY, TECHNOLOGY. Lists various LED models and their specifications.

\*\* Please see document "Vishay Material Category Policy": www.vishay.com/doc?99902

PARTS TABLE		
TLHO4400	Soft orange, $I_V > 1.6$ mcd	GaAsP on GaP
TLHO4400-AS12Z	Soft orange, $I_V > 1.6$ mcd	GaAsP on GaP
TLHO4400-MS12Z	Soft orange, $I_V > 1.6$ mcd	GaAsP on GaP
TLHR4400	Red, $I_V > 1.6$ mcd	GaAsP on GaP
TLHR4400-AS12	Red, $I_V > 1.6$ mcd	GaAsP on GaP
TLHR4400-AS21	Red, $I_V > 1.6$ mcd	GaAsP on GaP
TLHR4400-AS12Z	Red, $I_V > 1.6$ mcd	GaAsP on GaP
TLHR4400-AS21Z	Red, $I_V > 1.6$ mcd	GaAsP on GaP
TLHR4400-MS12Z	Red, $I_V > 1.6$ mcd	GaAsP on GaP
TLHR4401	Red, $I_V > 2.5$ mcd	GaAsP on GaP
TLHR4401-AS12Z	Red, $I_V > 2.5$ mcd	GaAsP on GaP
TLHR4401-LS12Z	Red, $I_V > 2.5$ mcd	GaAsP on GaP
TLHR4405	Red, $I_V > 6.3$ mcd	GaAsP on GaP
TLHR4405-AS12	Red, $I_V > 6.3$ mcd	GaAsP on GaP
TLHR4405-AS21	Red, $I_V > 6.3$ mcd	GaAsP on GaP
TLHR4407	Red, $I_V = (4 \text{ to } 12.5)$ mcd	GaAsP on GaP
TLHR4407-MS12Z	Red, $I_V = (4 \text{ to } 12.5)$ mcd	GaAsP on GaP

ABSOLUTE MAXIMUM RATINGS ( $T_{amb} = 25$ °C, unless otherwise specified) TLHG440. , TLHO440. , TLHP440. , TLHR440. , TLHY440.				
PARAMETER	TEST CONDITION	SYMBOL	VALUE	UNIT
Reverse voltage		$V_R$	6	V
DC Forward current		$I_F$	30	mA
Surge forward current	$t_p \leq 10$ $\mu$ s	$I_{FSM}$	1	A
Power dissipation	$T_{amb} \leq 60$ °C	$P_V$	100	mW
Junction temperature		$T_j$	100	°C
Operating temperature range		$T_{amb}$	- 40 to + 100	°C
Storage temperature range		$T_{stg}$	- 55 to + 100	°C
Soldering temperature	$t \leq 5$ s, 2 mm from body	$T_{sd}$	260	°C
Thermal resistance junction/ambient		$R_{thJA}$	400	K/W

OPTICAL AND ELECTRICAL CHARACTERISTICS ( $T_{amb} = 25$ °C, unless otherwise specified) TLHR440., RED							
PARAMETER	TEST CONDITION	PART	SYMBOL	MIN.	TYP.	MAX.	UNIT
Luminous intensity <sup>1)</sup>	$I_F = 10$ mA	TLHR4400	$I_V$	1.6	3		mcd
		TLHR4401	$I_V$	2.5	5		mcd
		TLHR4405	$I_V$	6.3	10		mcd
		TLHR4407	$I_V$	4		12.5	mcd
Dominant wavelength	$I_F = 10$ mA		$\lambda_d$	612		625	nm
Peak wavelength	$I_F = 10$ mA		$\lambda_p$		635		nm
Angle of half intensity	$I_F = 10$ mA		$\varphi$		$\pm 30$		deg
Forward voltage	$I_F = 20$ mA		$V_F$		2	3	V
Reverse voltage	$I_R = 10$ $\mu$ A		$V_R$	6	15		V
Junction capacitance	$V_R = 0$ , $f = 1$ MHz		$C_j$		50		pF

Note:

<sup>1)</sup> In one packing unit  $I_{Vmin.}/I_{Vmax.} \leq 0.5$



<b>OPTICAL AND ELECTRICAL CHARACTERISTICS</b> ( $T_{amb} = 25\text{ }^{\circ}\text{C}$ , unless otherwise specified) <b>TLHO440, SOFT ORANGE</b>							
PARAMETER	TEST CONDITION	PART	SYMBOL	MIN.	TYP.	MAX.	UNIT
Luminous intensity <sup>1)</sup>	$I_F = 10\text{ mA}$	TLHO4400	$I_V$	1.6	4		mcd
Dominant wavelength	$I_F = 10\text{ mA}$		$\lambda_d$	598		611	nm
Peak wavelength	$I_F = 10\text{ mA}$		$\lambda_p$		605		nm
Angle of half intensity	$I_F = 10\text{ mA}$		$\phi$		$\pm 30$		deg
Forward voltage	$I_F = 20\text{ mA}$		$V_F$		2.4	3	V
Reverse voltage	$I_R = 10\text{ }\mu\text{A}$		$V_R$	6	15		V
Junction capacitance	$V_R = 0, f = 1\text{ MHz}$		$C_j$		15		pF

Note:

<sup>1)</sup> In one packing unit  $I_{Vmin.}/I_{Vmax.} \leq 0.5$

<b>OPTICAL AND ELECTRICAL CHARACTERISTICS</b> ( $T_{amb} = 25\text{ }^{\circ}\text{C}$ , unless otherwise specified) <b>TLHY440., YELLOW</b>							
PARAMETER	TEST CONDITION	PART	SYMBOL	MIN.	TYP.	MAX.	UNIT
Luminous intensity <sup>1)</sup>	$I_F = 10\text{ mA}$	TLHY4400	$I_V$	1.6	3		mcd
		TLHY4401	$I_V$	2.5	5		mcd
		TLHY4405	$I_V$	6.3	10		mcd
Dominant wavelength	$I_F = 10\text{ mA}$		$\lambda_d$	581		594	nm
Peak wavelength	$I_F = 10\text{ mA}$		$\lambda_p$		585		nm
Angle of half intensity	$I_F = 10\text{ mA}$		$\phi$		$\pm 30$		deg
Forward voltage	$I_F = 20\text{ mA}$		$V_F$		2.4	3	V
Reverse voltage	$I_R = 10\text{ }\mu\text{A}$		$V_R$	6	15		V
Junction capacitance	$V_R = 0, f = 1\text{ MHz}$		$C_j$		50		pF

Note:

<sup>1)</sup> In one packing unit  $I_{Vmin.}/I_{Vmax.} \leq 0.5$

<b>OPTICAL AND ELECTRICAL CHARACTERISTICS</b> ( $T_{amb} = 25\text{ }^{\circ}\text{C}$ , unless otherwise specified) <b>TLHG440., GREEN</b>							
PARAMETER	TEST CONDITION	PART	SYMBOL	MIN.	TYP.	MAX.	UNIT
Luminous intensity <sup>1)</sup>	$I_F = 10\text{ mA}$	TLHG4400	$I_V$	2.5	4		mcd
		TLHG4401	$I_V$	4	6		mcd
		TLHG4405	$I_V$	6.3	12		mcd
Dominant wavelength	$I_F = 10\text{ mA}$		$\lambda_d$	562		575	nm
Peak wavelength	$I_F = 10\text{ mA}$		$\lambda_p$		565		nm
Angle of half intensity	$I_F = 10\text{ mA}$		$\phi$		$\pm 30$		deg
Forward voltage	$I_F = 20\text{ mA}$		$V_F$		2.4	3	V
Reverse voltage	$I_R = 10\text{ }\mu\text{A}$		$V_R$	6	15		V
Junction capacitance	$V_R = 0, f = 1\text{ MHz}$		$C_j$		50		pF

Note:

<sup>1)</sup> In one packing unit  $I_{Vmin.}/I_{Vmax.} \leq 0.5$

<b>OPTICAL AND ELECTRICAL CHARACTERISTICS</b> ( $T_{amb} = 25\text{ }^{\circ}\text{C}$ , unless otherwise specified)							
<b>TLHP440., PURE GREEN</b>							
PARAMETER	TEST CONDITION	PART	SYMBOL	MIN.	TYP.	MAX.	UNIT
Luminous intensity <sup>1)</sup>	$I_F = 10\text{ mA}$	TLHP4401	$I_V$	1	3		mcd
Dominant wavelength	$I_F = 10\text{ mA}$		$\lambda_d$	555		565	nm
Peak wavelength	$I_F = 10\text{ mA}$		$\lambda_p$		555		nm
Angle of half intensity	$I_F = 10\text{ mA}$		$\varphi$		$\pm 30$		deg
Forward voltage	$I_F = 20\text{ mA}$		$V_F$		2.4	3	V
Reverse voltage	$I_R = 10\text{ }\mu\text{A}$		$V_R$	6	15		V
Junction capacitance	$V_R = 0, f = 1\text{ MHz}$		$C_j$		50		pF

Note:

<sup>1)</sup> In one packing unit  $I_{Vmin.}/I_{Vmax.} \leq 0.5$

<b>LUMINOUS INTENSITY CLASSIFICATION</b>		
GROUP	LIGHT INTENSITY (mcd)	
	MIN.	MAX.
STANDARD		
L	1	2
M	1.6	3.2
N	2.5	5
P	4	8
Q	6.3	12.5
R	10	20
S	16	32
T	25	50
U	40	80

Note:

Luminous intensity is tested at a current pulse duration of 25 ms and an accuracy of  $\pm 11\%$ .

The above type numbers represent the order groups which include only a few brightness groups. Only one group will be shipped on each bag (there will be no mixing of two groups on each bag).

In order to ensure availability, single brightness groups will not be orderable.

In a similar manner for colors where wavelength groups are measured and binned, single wavelength groups will be shipped on any one bag. In order to ensure availability, single wavelength groups will not be orderable.

<b>COLOR CLASSIFICATION</b>						
GROUP	DOM. WAVELENGTH (nm)					
	YELLOW		GREEN		PURE GREEN	
	MIN.	MAX.	MIN.	MAX.	MIN.	MAX.
0					555	559
1	581	584			558	561
2	583	586			560	563
3	585	588	562	565	562	565
4	587	590	564	567		
5	589	592	566	569		
6	591	594	568	571		
7			570	573		
8			572	575		

Note:

Wavelengths are tested at a current pulse duration of 25 ms.

**TYPICAL CHARACTERISTICS** ( $T_{amb} = 25\text{ }^{\circ}\text{C}$ , unless otherwise specified)

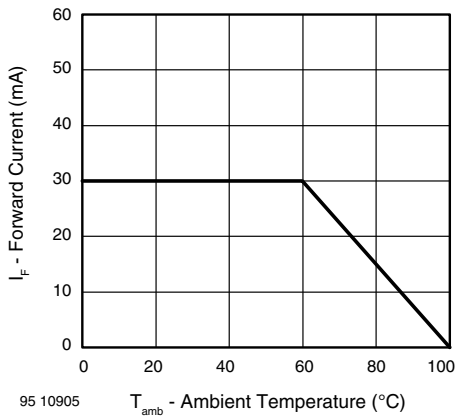

Figure 1. Forward Current vs. Ambient Temperature for InGaN

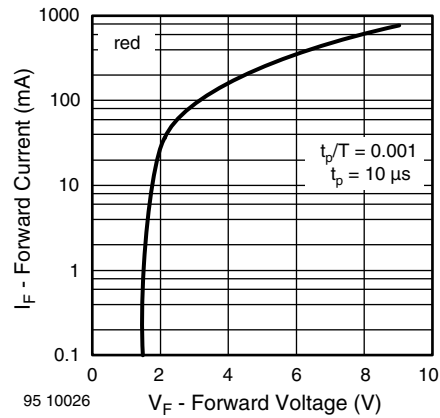

Figure 4. Forward Current vs. Forward Voltage

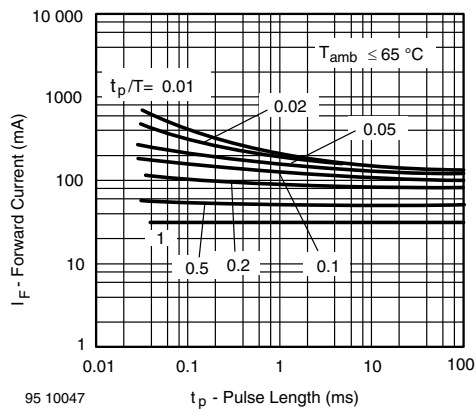

Figure 2. Forward Current vs. Pulse Length

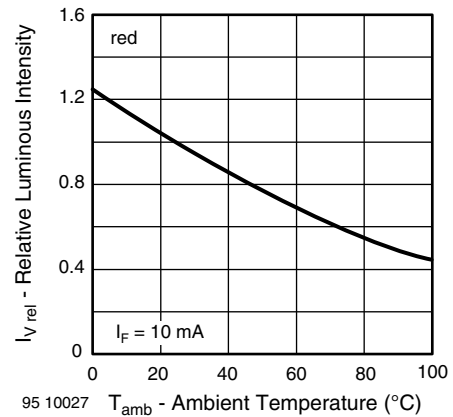

Figure 5. Rel. Luminous Intensity vs. Ambient Temperature

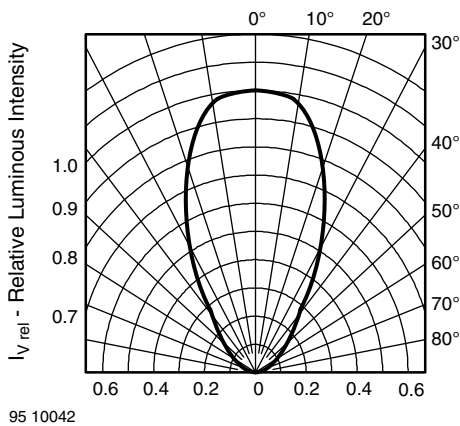

Figure 3. Rel. Luminous Intensity vs. Angular Displacement

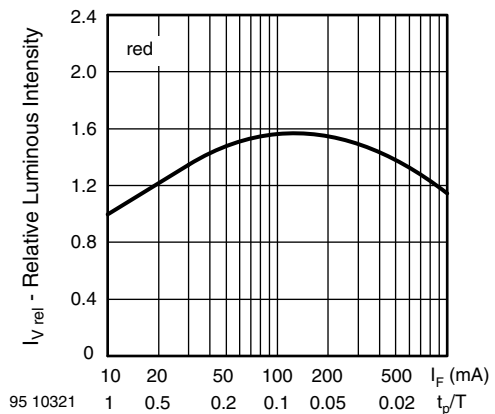

Figure 6. Rel. Lumin. Intensity vs. Forw. Current/Duty Cycle

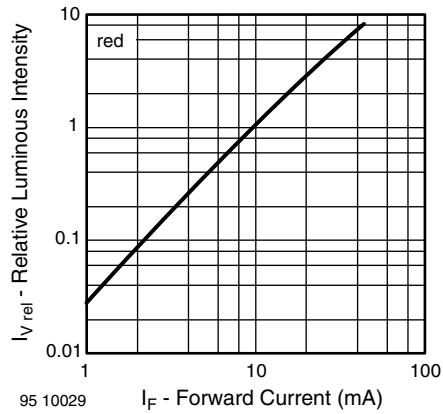

Figure 7. Relative Luminous Intensity vs. Forward Current

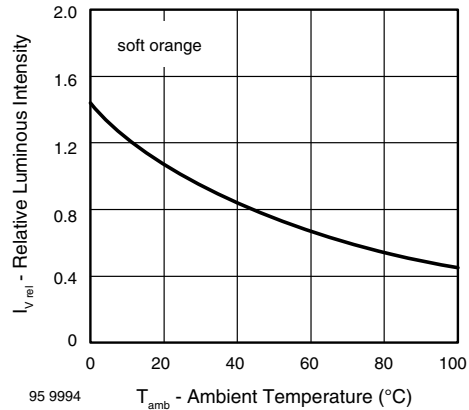

Figure 10. Rel. Luminous Intensity vs. Ambient Temperature

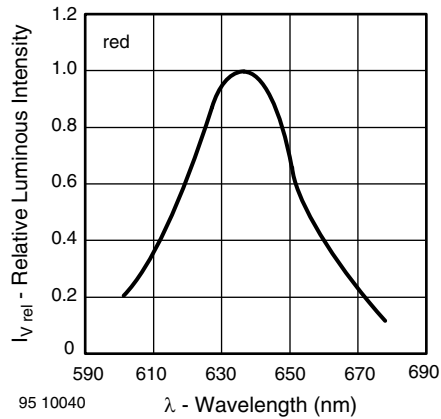

Figure 8. Relative Intensity vs. Wavelength

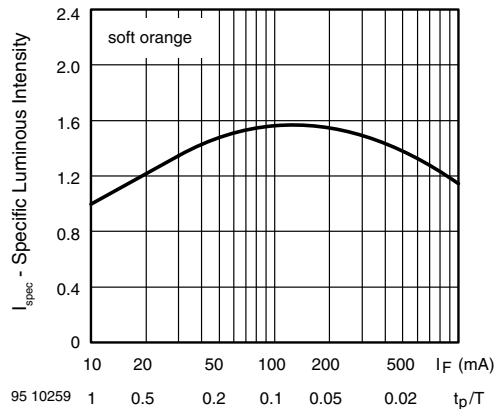

Figure 11. Rel. Lumin. Intensity vs. Forw. Current/Duty Cycle

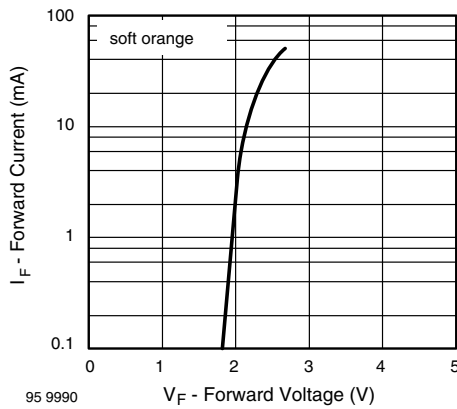

Figure 9. Forward Current vs. Forward Voltage

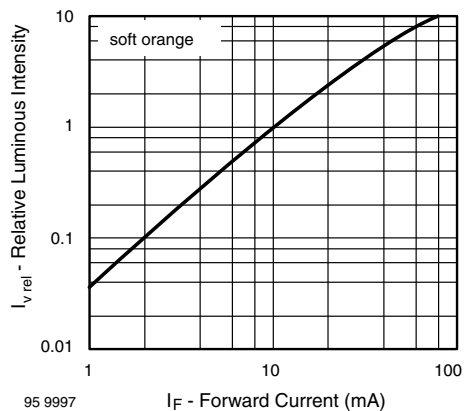

Figure 12. Relative Luminous Intensity vs. Forward Current

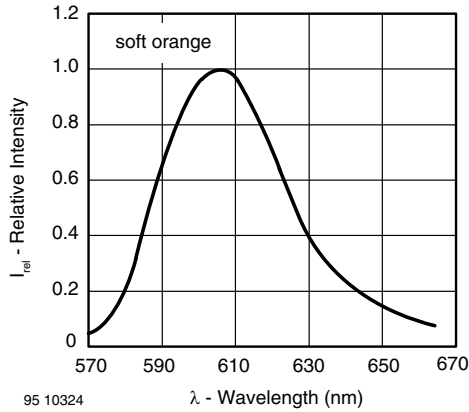

Figure 13. Relative Intensity vs. Wavelength

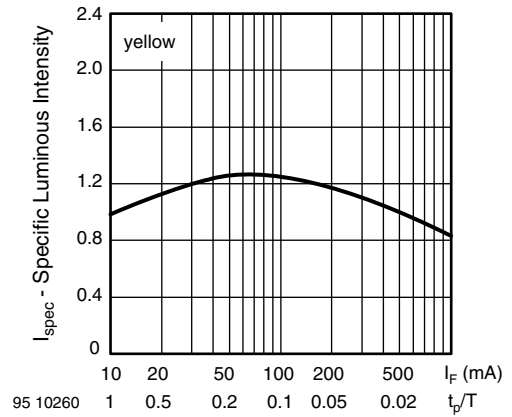

Figure 16. Rel. Lumin. Intensity vs. Forw. Current/Duty Cycle

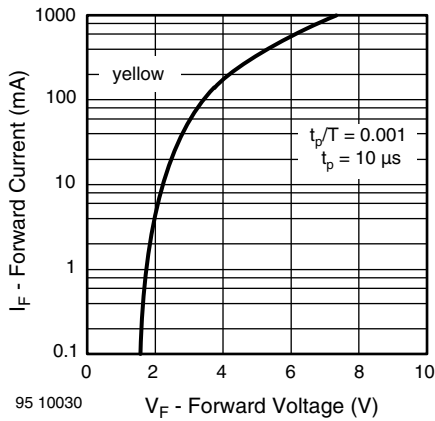

Figure 14. Forward Current vs. Forward Voltage

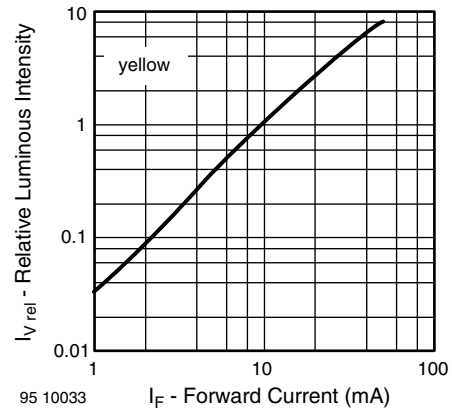

Figure 17. Relative Luminous Intensity vs. Forward Current

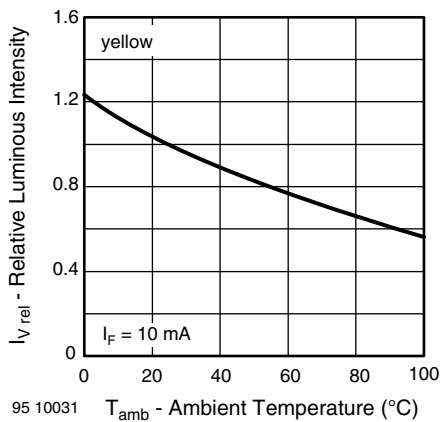

Figure 15. Rel. Luminous Intensity vs. Ambient Temperature

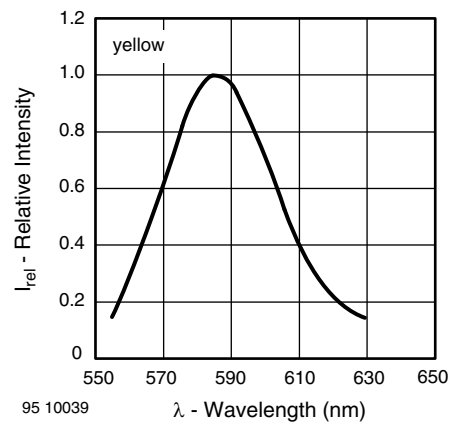

Figure 18. Relative Intensity vs. Wavelength

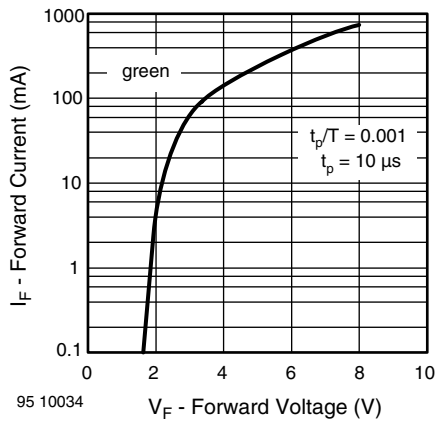

Figure 19. Forward Current vs. Forward Voltage

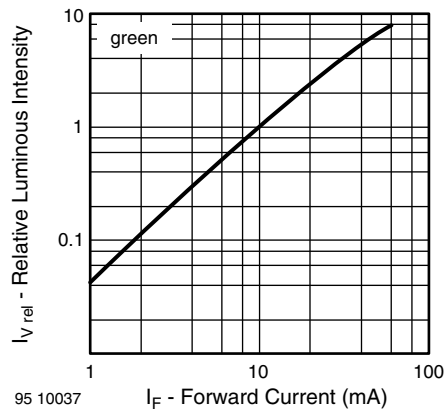

Figure 22. Relative Luminous Intensity vs. Forward Current

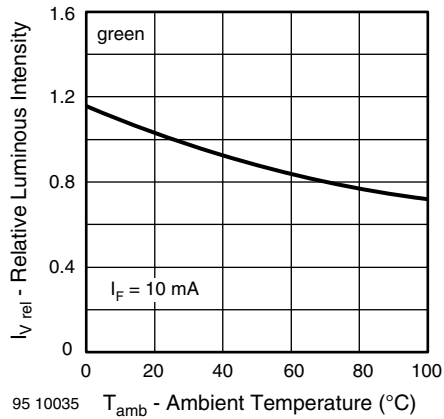

Figure 20. Rel. Luminous Intensity vs. Ambient Temperature

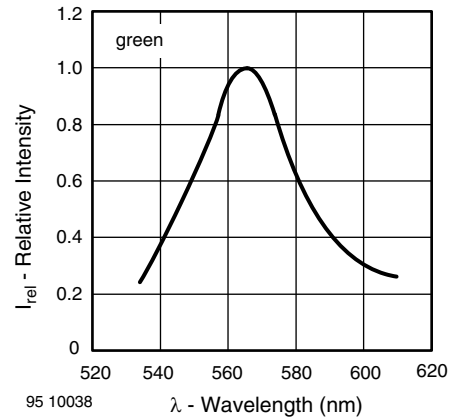

Figure 23. Relative Intensity vs. Wavelength

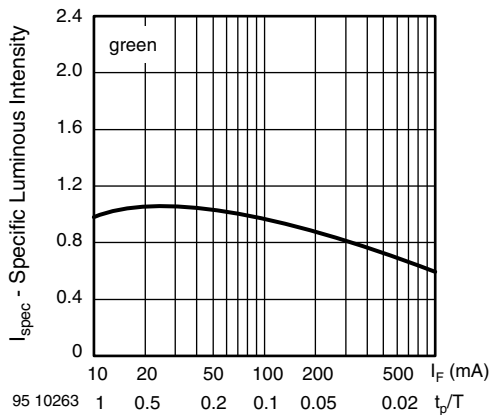

Figure 21. Specific Luminous Intensity vs. Forward Current

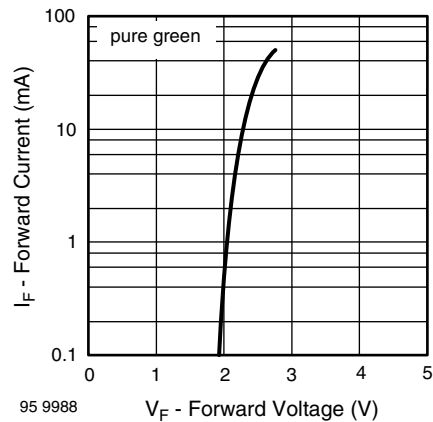

Figure 24. Forward Current vs. Forward Voltage



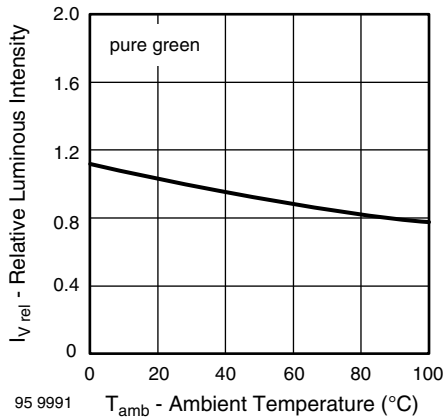

Figure 25. Rel. Luminous Intensity vs. Ambient Temperature

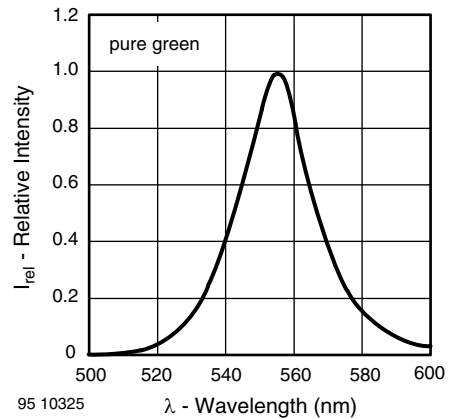

Figure 28. Relative Intensity vs. Wavelength

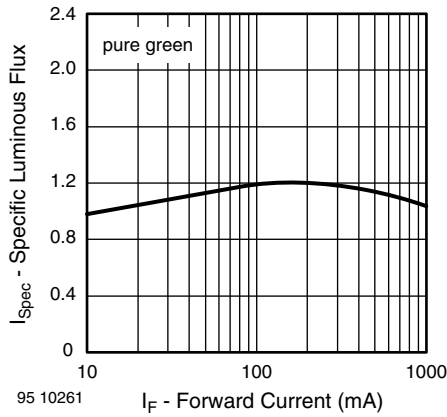

Figure 26. Specific Luminous Intensity vs. Forward Current

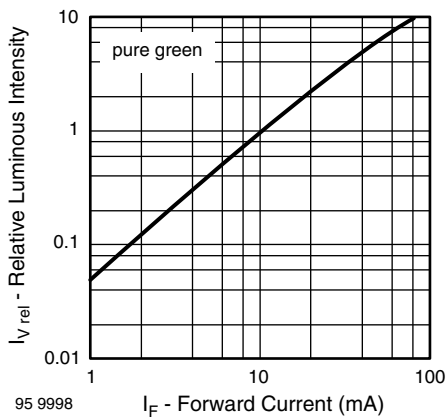
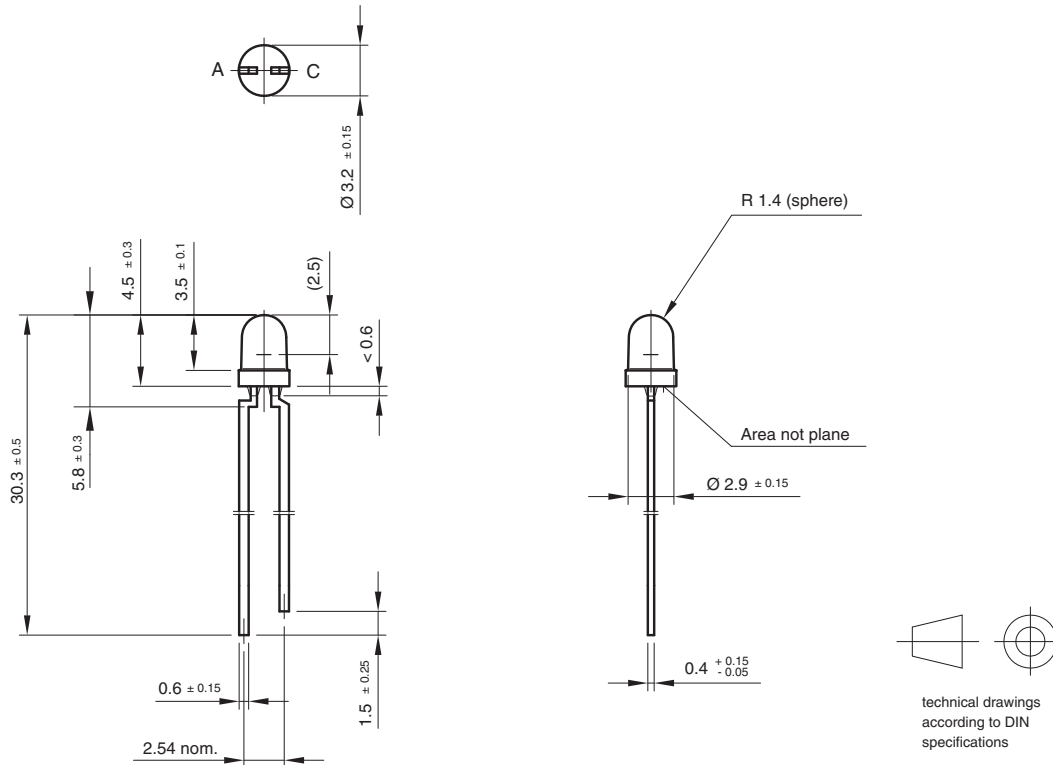

Figure 27. Relative Luminous Intensity vs. Forward Current

**PACKAGE DIMENSIONS** in millimeters



Drawing-No.: 6.544-5255.01-4  
 Issue: 7; 25.09.08  
 95 10913

**REEL DIMENSIONS** in millimeters

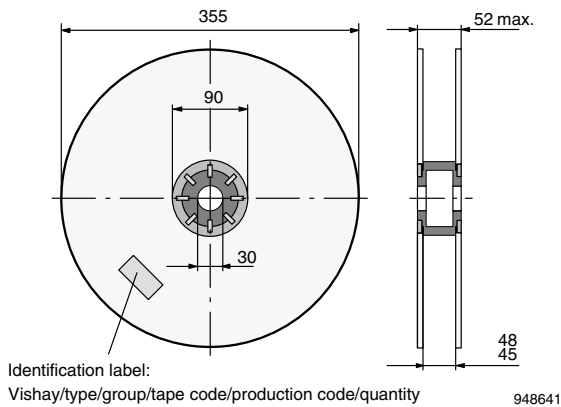

Figure 29. Reel

**TAPE**

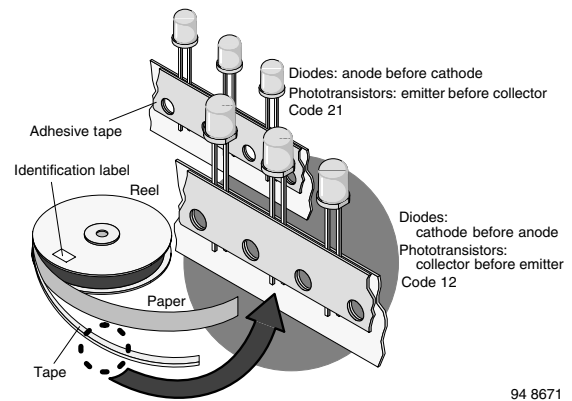
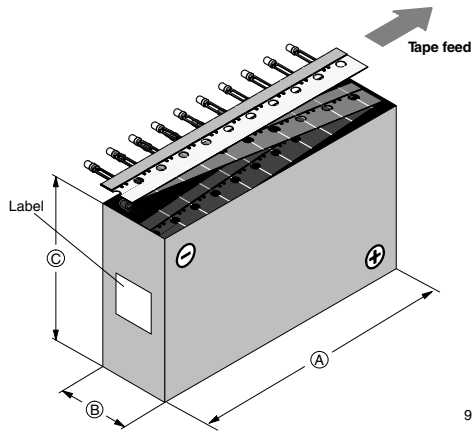

Figure 30. LED in Tape

**AMMOPACK**



94 8667-1

Figure 31. Tape Direction

Note:  
AS12Z and AS21Z still valid for already existing types BUT NOT  
FOR NEW DESIGN

**TAPE DIMENSIONS** in millimeters

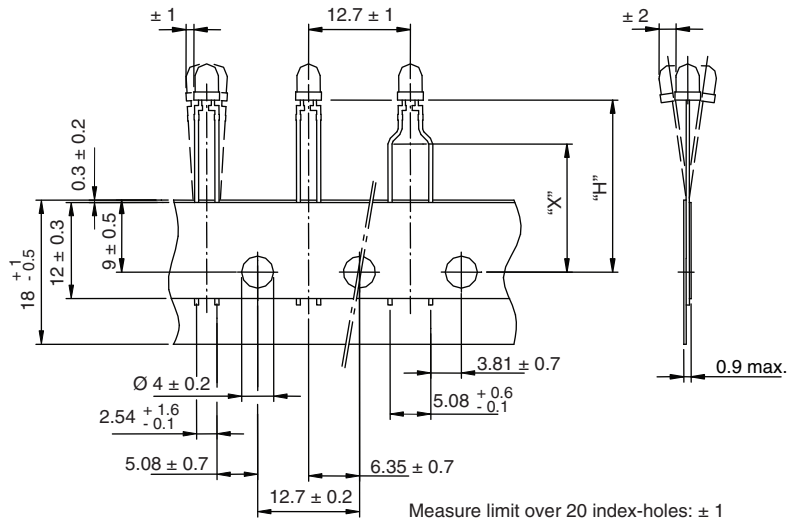

Quantity per:	Reel (Mat.-no. 1764)
	2000

21885

Option	Dim. "H" ± 0.5 mm	Dim. "X" ± 0.5 mm
AS	17.3	
MS	25.5	
CS	22.0	
LS	21.0	
BT	20.0	16.0



## Disclaimer

ALL PRODUCT, PRODUCT SPECIFICATIONS AND DATA ARE SUBJECT TO CHANGE WITHOUT NOTICE TO IMPROVE RELIABILITY, FUNCTION OR DESIGN OR OTHERWISE.

Vishay Intertechnology, Inc., its affiliates, agents, and employees, and all persons acting on its or their behalf (collectively, "Vishay"), disclaim any and all liability for any errors, inaccuracies or incompleteness contained in any datasheet or in any other disclosure relating to any product.

Vishay makes no warranty, representation or guarantee regarding the suitability of the products for any particular purpose or the continuing production of any product. To the maximum extent permitted by applicable law, Vishay disclaims (i) any and all liability arising out of the application or use of any product, (ii) any and all liability, including without limitation special, consequential or incidental damages, and (iii) any and all implied warranties, including warranties of fitness for particular purpose, non-infringement and merchantability.

Statements regarding the suitability of products for certain types of applications are based on Vishay's knowledge of typical requirements that are often placed on Vishay products in generic applications. Such statements are not binding statements about the suitability of products for a particular application. It is the customer's responsibility to validate that a particular product with the properties described in the product specification is suitable for use in a particular application. Parameters provided in datasheets and/or specifications may vary in different applications and performance may vary over time. All operating parameters, including typical parameters, must be validated for each customer application by the customer's technical experts. Product specifications do not expand or otherwise modify Vishay's terms and conditions of purchase, including but not limited to the warranty expressed therein.

Except as expressly indicated in writing, Vishay products are not designed for use in medical, life-saving, or life-sustaining applications or for any other application in which the failure of the Vishay product could result in personal injury or death. Customers using or selling Vishay products not expressly indicated for use in such applications do so at their own risk and agree to fully indemnify and hold Vishay and its distributors harmless from and against any and all claims, liabilities, expenses and damages arising or resulting in connection with such use or sale, including attorneys fees, even if such claim alleges that Vishay or its distributor was negligent regarding the design or manufacture of the part. Please contact authorized Vishay personnel to obtain written terms and conditions regarding products designed for such applications.

No license, express or implied, by estoppel or otherwise, to any intellectual property rights is granted by this document or by any conduct of Vishay. Product names and markings noted herein may be trademarks of their respective owners.