

## Standard SMD LED PLCC-2

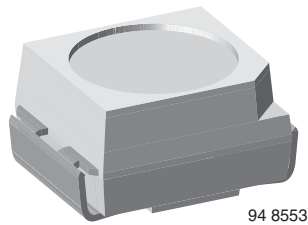

94 8553

### DESCRIPTION

This device has been designed for applications requiring narrow brightness and color selection.

The package of this device is the PLCC-2.

It consists of a lead frame which is embedded in a white thermoplast. The reflector inside this package is filled up with clear epoxy.

### PRODUCT GROUP AND PACKAGE DATA

- Product group: LED
- Package: SMD PLCC-2
- Product series: standard
- Angle of half intensity:  $\pm 60^\circ$

### FEATURES

- SMD LED with exceptional brightness
- Luminous intensity categorized
- Compatible with automatic placement equipment
- EIA and ICE standard package
- Compatible with infrared, vapor phase and wave solder processes according to CECC
- Available in 8 mm tape
- Low profile package
- Non-diffused lens: excellent for coupling to light pipes and backlighting
- Low power consumption
- Luminous intensity ratio in one packaging unit  $I_{Vmax}/I_{Vmin.} \leq 1.6$
- preconditioning: acc. to JEDEC level 2a
- ESD-withstand voltage: up to 1 kV according to JESD22-A114-B
- Compliant to RoHS Directive 2002/95/EC and in accordance to WEEE 2002/96/EC
- AEC-Q101 qualified

**RoHS**  
COMPLIANT

**GREEN**  
(5-2008)\*\*

### APPLICATIONS

- Automotive: backlighting in dashboards and switches
- Telecommunication: indicator and backlighting in telephone and fax
- Indicator and backlight for audio and video equipment
- Indicator and backlight in office equipment
- Flat backlight for LCDs, switches and symbols
- General use

### PARTS TABLE

PART	COLOR, LUMINOUS INTENSITY	TECHNOLOGY
VLMS3100-GS08	Red, $I_V > 2.8$ mcd	GaAsP on GaP
VLMS3100-GS18	Red, $I_V > 2.8$ mcd	GaAsP on GaP
VLMS3101-GS08	Red, $I_V = (4.5 \text{ to } 11.2)$ mcd	GaAsP on GaP
VLMS3101-GS18	Red, $I_V = (4.5 \text{ to } 11.2)$ mcd	GaAsP on GaP

\*\* Please see document "Vishay Material Category Policy": [www.vishay.com/doc?99902](http://www.vishay.com/doc?99902)

ABSOLUTE MAXIMUM RATINGS <sup>1)</sup> VLMS310.				
PARAMETER	TEST CONDITION	SYMBOL	VALUE	UNIT
Reverse voltage <sup>2)</sup>		$V_R$	6	V
DC forward current	$T_{amb} \leq 60\text{ }^\circ\text{C}$	$I_F$	30	mA
Surge forward current	$t_p \leq 10\text{ }\mu\text{s}$	$I_{FSM}$	0.5	A
Power dissipation	$T_{amb} \leq 60\text{ }^\circ\text{C}$	$P_V$	100	mW
Junction temperature		$T_j$	100	$^\circ\text{C}$
Operating temperature range		$T_{amb}$	- 40 to + 100	$^\circ\text{C}$
Storage temperature range		$T_{stg}$	- 40 to + 100	$^\circ\text{C}$
Soldering temperature	$t \leq 5\text{ s}$	$T_{sd}$	260	$^\circ\text{C}$
Thermal resistance junction/ambient	Mounted on PC board (pad size > 16 mm <sup>2</sup> )	$R_{thJA}$	400	K/W

Notes:

<sup>1)</sup>  $T_{amb} = 25\text{ }^\circ\text{C}$ , unless otherwise specified

<sup>2)</sup> Driving LED in reverse direction is suitable for short term application

OPTICAL AND ELECTRICAL CHARACTERISTICS <sup>1)</sup> VLMS310., RED							
PARAMETER	TEST CONDITION	PART	SYMBOL	MIN	TYP.	MAX	UNIT
Luminous intensity <sup>2)</sup>	$I_F = 10\text{ mA}$	VLMS3100	$I_V$	2.8	7.1		mcd
		VLMS3101	$I_V$	4.5		11.2	mcd
Dominant wavelength	$I_F = 10\text{ mA}$		$\lambda_d$	624	630	636	nm
Peak wavelength	$I_F = 10\text{ mA}$		$\lambda_p$		640		nm
Angle of half intensity	$I_F = 10\text{ mA}$		$\phi$		$\pm 60$		deg
Forward voltage	$I_F = 20\text{ mA}$		$V_F$		2.0	2.6	V
Reverse voltage	$I_R = 10\text{ }\mu\text{A}$		$V_R$	6			V
Junction capacitance	$V_R = 0, f = 1\text{ MHz}$		$C_j$		7		pF
Temperature coefficient of $V_F$	$I_F = 20\text{ mA}$		$TC_{V_F}$		- 1.8		mV/K
Temperature coefficient of $\lambda_d$	$I_F = 10\text{ mA}$		$TC_{\lambda_d}$		0.05		nm/K

Notes:

<sup>1)</sup>  $T_{amb} = 25\text{ }^\circ\text{C}$ , unless otherwise specified

<sup>2)</sup> In one Packing Unit  $I_{Vmax}/I_{Vmin.} \leq 1.6$

LUMINOUS INTENSITY CLASSIFICATION				
GROUP	LIGHT INTENSITY (mcd)			
	STANDARD	OPTIONAL	MIN.	MAX.
H	1	2.80	3.55	
	2	3.55	4.50	
J	1	4.50	5.60	
	2	5.60	7.10	
K	1	7.10	9.00	
	2	9.00	11.20	
L	1	11.20	14.00	
	2	14.00	18.00	

Note:

Luminous intensity is tested at a current pulse duration of 25 ms and an accuracy of  $\pm 11\%$ .

The above Type Numbers represent the order groups which include only a few brightness groups. Only one group will be shipped on each reel (there will be no mixing of two groups on each reel).

In order to ensure availability, single brightness groups will not be orderable.

In a similar manner for colors where wavelength groups are measured and binned, single wavelength groups will be shipped on any one reel.

In order to ensure availability, single wavelength groups will not be orderable.

CROSSING TABLE	
VISHAY	OSRAM
VLMS3100	LST670-J1L2
VLMS3101	LST670-J1K2

**TYPICAL CHARACTERISTICS**

$T_{amb} = 25\text{ }^{\circ}\text{C}$ , unless otherwise specified

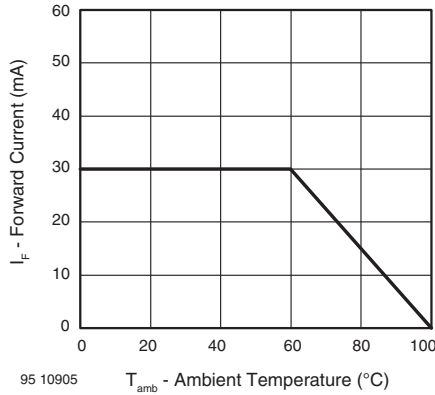

Figure 1. Forward Current vs. Ambient Temperature

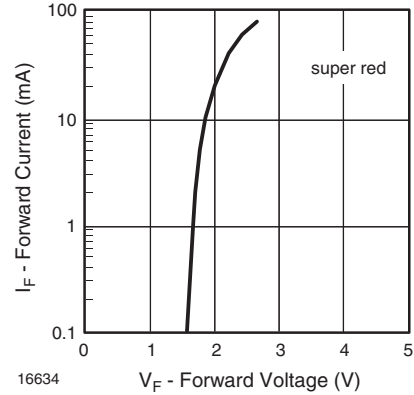

Figure 4. Forward Current vs. Forward Voltage

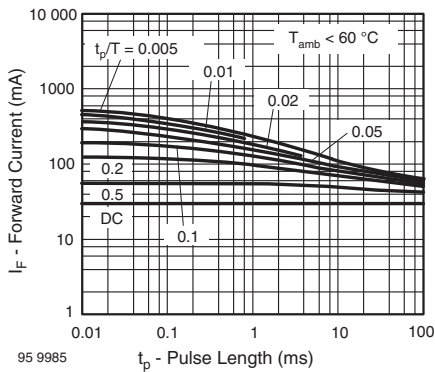

Figure 2. Forward Current vs. Pulse Length

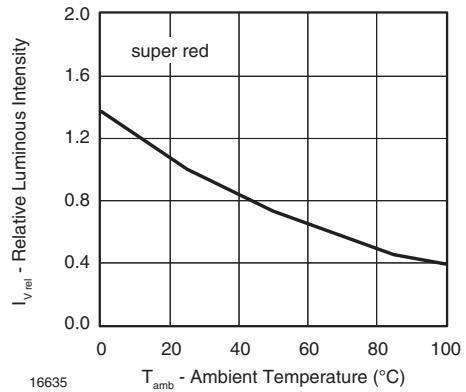

Figure 5. Rel. Luminous Intensity vs. Ambient Temperature

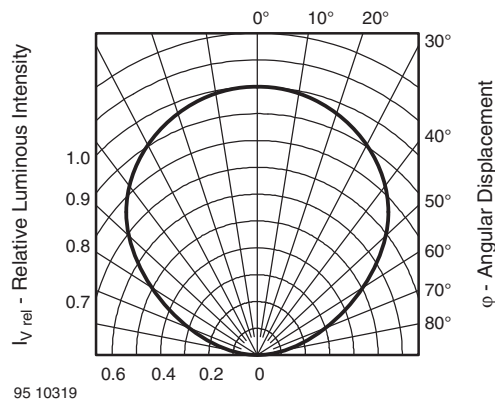

Figure 3. Rel. Luminous Intensity vs. Angular Displacement

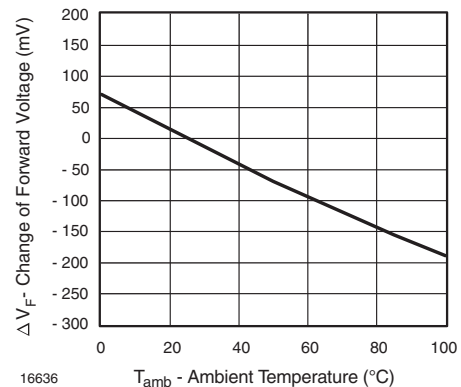

Figure 6. Change of Forward Voltage vs. Ambient Temperature

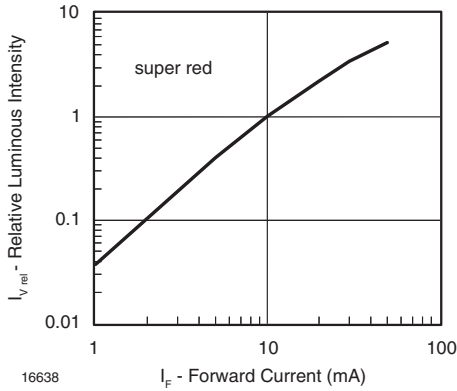

Figure 7. Relative Luminous Intensity vs. Forward Current

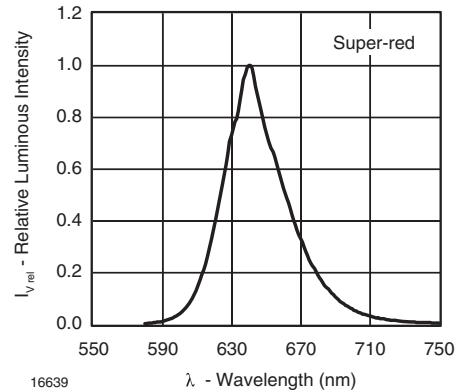

Figure 9. Relative Luminous Intensity vs. Wavelength

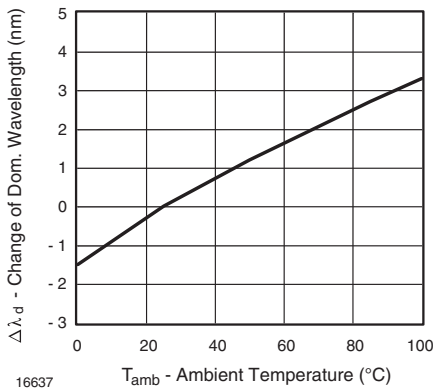
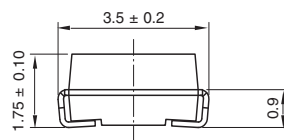
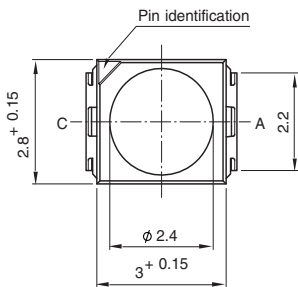

Figure 8. Change of Dominant Wavelength vs. Ambient Temperature

**PACKAGE DIMENSIONS** in millimeters



technical drawings according to DIN specifications



Drawing-No.: 6.541-5025.01-4  
Issue: 8; 22.11.05  
95 11314-1

**Mounting Pad Layout**

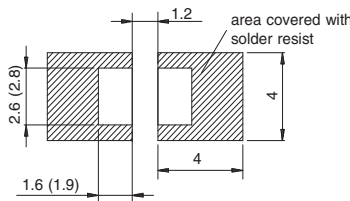

**METHOD OF TAPING/POLARITY AND TAPE AND REEL**

**SMD LED (VLM.3 - SERIES)**

Vishay's LEDs in SMD packages are available in an antistatic 8 mm blister tape (in accordance with DIN IEC 40 (CO) 564) for automatic component insertion. The blister tape is a plastic strip with impressed component cavities, covered by a top tape.

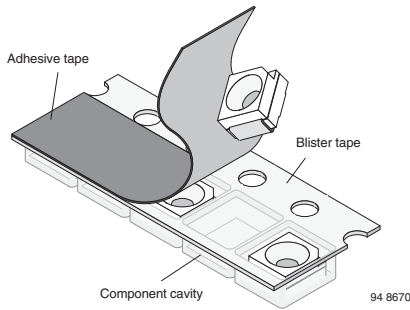

**REEL PACKAGE DIMENSION IN MILLIMETERS FOR SMD LEDs, TAPE OPTION GS18 (= 8000 PCS.) PREFERRED**

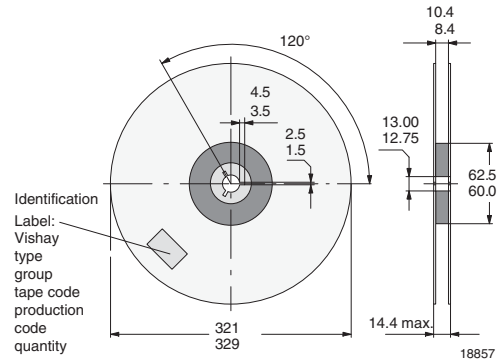

Figure 12. Reel Dimensions - GS18

**TAPING OF VLM.3...**

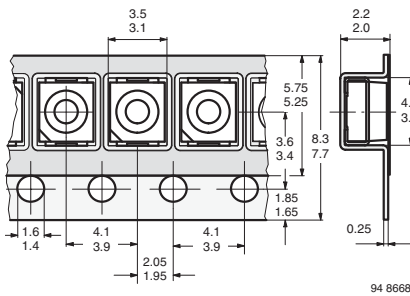

Figure 10. Tape Dimensions in mm for PLCC-2

**SOLDERING PROFILE**

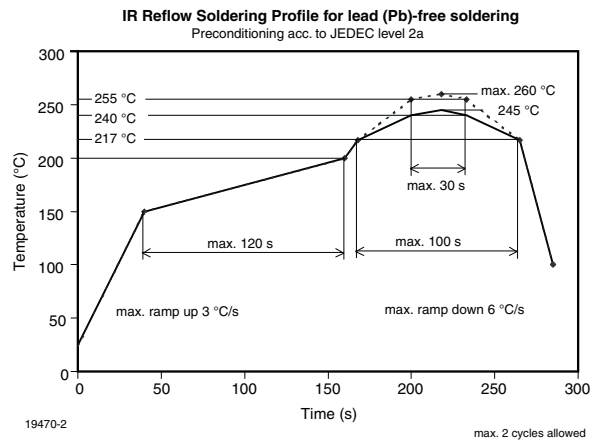

Figure 13. Vishay Lead (Pb)-free Reflow Soldering Profile (acc. to J-STD-020)

**REEL PACKAGE DIMENSION IN MILLIMETERS FOR SMD LEDs, TAPE OPTION GS08 (= 1500 PCS.)**

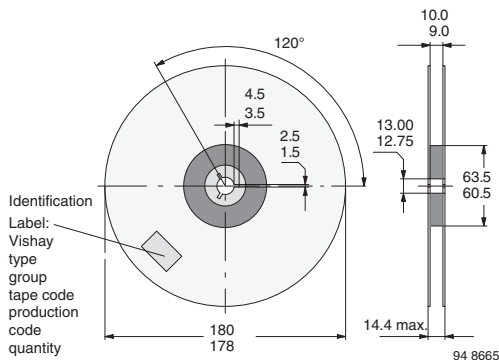

Figure 11. Reel Dimensions - GS08

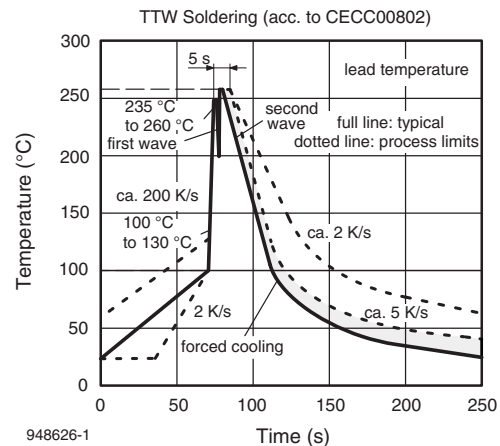
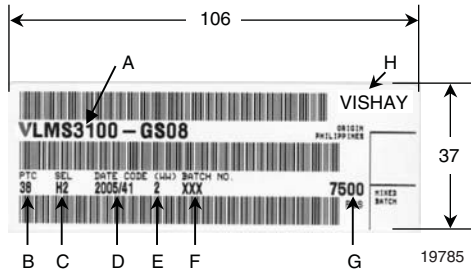

Figure 14. Double Wave Soldering of Opto Devices (all Packages)

## BAR CODE PRODUCT LABEL



- A) Type of component
- B) Manufacturing plant
- C) SEL - selection code (bin):  
e.g.: R2 = code for luminous intensity group  
3 = code for color group
- D) Date code year/week
- E) Day code (e.g. 3: Wednesday)
- F) Batch no.
- G) Total quantity
- H) Company code

## DRY PACKING

The reel is packed in an anti-humidity bag to protect the devices from absorbing moisture during transportation and storage.

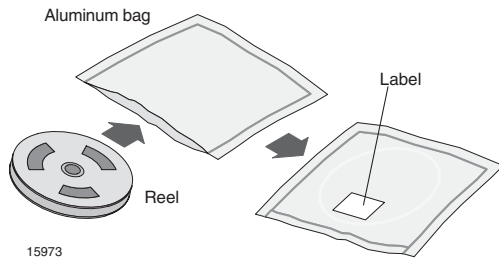

## FINAL PACKING

The sealed reel is packed into a cardboard box. A secondary cardboard box is used for shipping purposes.

## RECOMMENDED METHOD OF STORAGE

Dry box storage is recommended as soon as the aluminum bag has been opened to prevent moisture absorption. The following conditions should be observed, if dry boxes are not available:

- Storage temperature 10 °C to 30 °C
- Storage humidity ≤ 60 % RH max.

After more than 672 h under these conditions moisture content will be too high for reflow soldering.

In case of moisture absorption, the devices will recover to the former condition by drying under the following condition:

- 192 h at 40 °C + 5 °C/- 0 °C and < 5 % RH (dry air/nitrogen) or
- 96 h at 60 °C + 5 °C and < 5 % RH for all device containers or
- 24 h at 100 °C + 5 °C not suitable for reel or tubes.

An EIA JEDEC standard JESD22-A112 level 2a label is included on all dry bags.

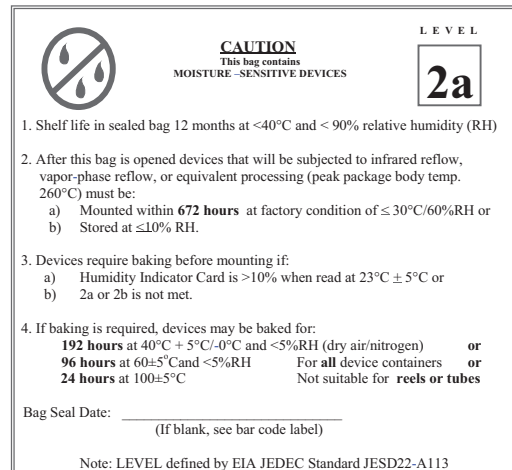

Example of JESD22-A112 level 2a label

## ESD PRECAUTION

Proper storage and handling procedures should be followed to prevent ESD damage to the devices especially when they are removed from the antistatic shielding bag. Electro-static sensitive devices warning labels are on the packaging.

## VISHAY SEMICONDUCTORS STANDARD BAR CODE LABELS

The Vishay Semiconductors standard bar code labels are printed at final packing areas. The labels are on each packing unit and contain Vishay Semiconductors specific data.



## Disclaimer

ALL PRODUCT, PRODUCT SPECIFICATIONS AND DATA ARE SUBJECT TO CHANGE WITHOUT NOTICE TO IMPROVE RELIABILITY, FUNCTION OR DESIGN OR OTHERWISE.

Vishay Intertechnology, Inc., its affiliates, agents, and employees, and all persons acting on its or their behalf (collectively, "Vishay"), disclaim any and all liability for any errors, inaccuracies or incompleteness contained in any datasheet or in any other disclosure relating to any product.

Vishay makes no warranty, representation or guarantee regarding the suitability of the products for any particular purpose or the continuing production of any product. To the maximum extent permitted by applicable law, Vishay disclaims (i) any and all liability arising out of the application or use of any product, (ii) any and all liability, including without limitation special, consequential or incidental damages, and (iii) any and all implied warranties, including warranties of fitness for particular purpose, non-infringement and merchantability.

Statements regarding the suitability of products for certain types of applications are based on Vishay's knowledge of typical requirements that are often placed on Vishay products in generic applications. Such statements are not binding statements about the suitability of products for a particular application. It is the customer's responsibility to validate that a particular product with the properties described in the product specification is suitable for use in a particular application. Parameters provided in datasheets and/or specifications may vary in different applications and performance may vary over time. All operating parameters, including typical parameters, must be validated for each customer application by the customer's technical experts. Product specifications do not expand or otherwise modify Vishay's terms and conditions of purchase, including but not limited to the warranty expressed therein.

Except as expressly indicated in writing, Vishay products are not designed for use in medical, life-saving, or life-sustaining applications or for any other application in which the failure of the Vishay product could result in personal injury or death. Customers using or selling Vishay products not expressly indicated for use in such applications do so at their own risk and agree to fully indemnify and hold Vishay and its distributors harmless from and against any and all claims, liabilities, expenses and damages arising or resulting in connection with such use or sale, including attorneys fees, even if such claim alleges that Vishay or its distributor was negligent regarding the design or manufacture of the part. Please contact authorized Vishay personnel to obtain written terms and conditions regarding products designed for such applications.

No license, express or implied, by estoppel or otherwise, to any intellectual property rights is granted by this document or by any conduct of Vishay. Product names and markings noted herein may be trademarks of their respective owners.