

**DESCRIPTION**

**Dual Drive, RangeMAX Wide Range Dimming, Single Output Inverter.** The LXM1614E series of Direct Drive<sup>TM</sup> CCFL (Cold Cathode Fluorescent Lamp) Inverter Modules is specifically designed for driving LCD backlight lamps. Although similar to the RangeMAX LXM1612 wide range dimming inverters, the LXM1614E family offers two separate brightness controls for lamp current amplitude and duty cycle. This innovation of dual brightness control with extended dimming, combined with Microsemi's high efficiency Direct Drive topology, provides the industry's most feature rich, small form factor inverter available. The wide range dimming provides exceptional display readability at less than 1% of full brightness, allowing both power savings and low ambient light operating capability.

**Dual Drive Dimming Control.** The inverters provide brightness adjustments utilizing standard lamp current amplitude control as well as supporting Microsemi's RangeMAX wide range dimming technique. Combining both brightness controls into a single inverter supports the "self heating" lamp technology by using a "boost" current feature and still offers duty cycle control for low brightness operation. This controlled overdrive capability eliminates the need for traditional resistive heater wire methods to ensure light output at extremely low temperatures. The LXM1614E brightness controls support temperature monitoring with look-up table applications by accepting either a PWM input or DC voltage. Large panel lamps with greater thermal inertia can also utilize this "instant-bright" feature and minimize warm up time.

(continued next page)

**IMPORTANT:** For the most current data, consult MICROSEMI's website: <http://www.microsemi.com>  
Protected by U.S. Patents: 5,923,129; 5,930,121; Patents Pending

**KEY FEATURES**

- Independent Brightness Controls For Lamp Current Amplitude and Duty Cycle
- RangeMAX 1-100% Wide Range Dimming with Controlled Overdrive Boost
- On-Board Thermister automatically limits maximum lamp current
- Supports Wide Input Voltage Range 9-16V
- High Efficiency, Single Stage Direct Drive Topology
- -40°C to +85°C Ambient Temperature Operation
- Output Open/Short Circuit Protection
- Up to 2000V Output Voltage Capability
- Single side PCB Component Layout

**APPLICATIONS**

- Self Heating And High Pressure Lamp Technology
- Automotive Navigation, GPS Systems, Auto PC
- Extended Cold Temperature Operation
- Aircraft Cabin Displays
- Low Ambient Light Conditions Requiring Wide Range Dimming
- "Instant On" To Full Brightness For Large LCD Backlight Panels
- Industrial Notebook And Workstations

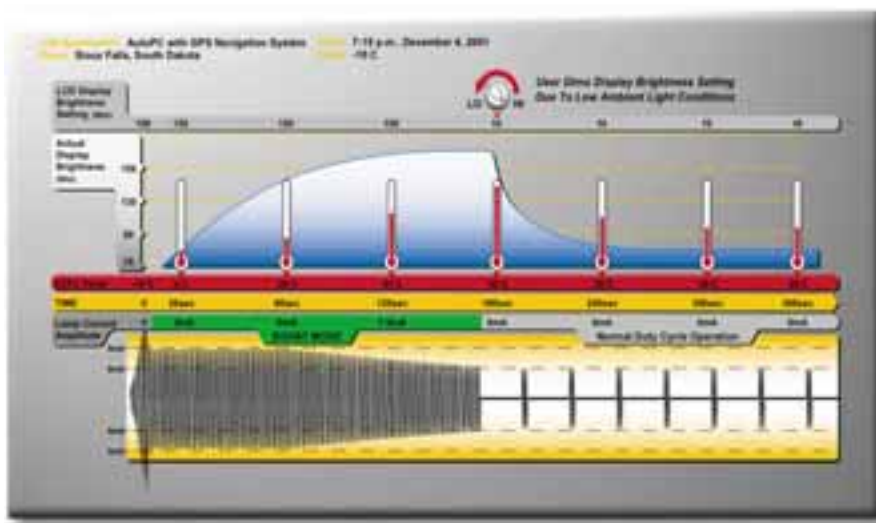
**PRODUCT HIGHLIGHT**

Controlled overdrive mode of LXM1614E Inverter accelerates lamp warm-up time to provide maximum light output even in extreme temperature environments

**MODULE ORDER INFO**

PART NUMBER	OUTPUT CONNECTOR	INVERTER MATES DIRECTLY TO PANEL CONNECTORS
LXM1614E-14-11	JST SM02(8.0)B-BHS-1-TB	BHR-03VS-1

**DESCRIPTION (CONTINUED)**

An on-board thermister monitors the inverter's relative temperature and limits the maximum allowable lamp current. This current limit automatically protects the lamp and inverter as a function of temperature, which helps control the system during Boost mode.

**RangeMAX Digital Dimming Technique.**

Digital dimming provides flicker-free brightness control in any wide range dimming application. With many panels dimming ratios greater than 100:1 can be achieved. A video synchronization feature allows wide ratio dimming without the display disturbances and interference seen with competitive products. The resultant "burst drive" that energized the lamp was designed specifically to ensure that no premature lamp degradation occurs. Even in overdrive boost mode, the waveform is carefully controlled to minimize the effects that are detrimental to lamp life. Individual panel specifications should be referenced for specific thermal and electrical parameters.

**Direct Drive Technology.**

The module design is based on the Direct Drive topology, which provides a number of cost, performance, and form factor advantages. The LXM1614E series inverters eliminate the classic resonant inductor/capacitors and integrate the wide range dimming logic into the controller.

**Additional Features.**

Other benefits of this new topology are fixed-frequency operation and secondary-side strike-voltage regulation. Strike-voltage regulation minimizes corona discharge in the output transformer and related circuitry, providing longer life and higher reliability. All LXM1614E modules feature both open and shorted lamp protection. The dual drive LXM1614E is fully customizable (electronically and mechanically) to specific customer requirements.

**ABSOLUTE MAXIMUM RATINGS (NOTE 1)**

Input Supply Voltage ( $V_{IN}$ ).....	-0.3V to 17V
Output Voltage, no load .....	Internally Limited to 2000V <sub>RMS</sub>
Output Current full boost .....	13mA <sub>RMS</sub> (<2 minutes @ $T_A$ <25°C)
Output Current nominal boost .....	6.1mA <sub>RMS</sub>
Output Power .....	10W (-40°C to 25°C)
Output Power .....	6W (26°C to 85°C)
Input Signal Voltage (BRITE, BOOST).....	-0.3V to 5.5V
Input Signal Voltage (SLEEP, $V_{SYNC}$ ) .....	-0.3V to 5.5V
Ambient Operating Temperature, zero airflow .....	-40°C to 85°C
Operating Relative Humidity, non-condensing .....	≤90%
Storage Temperature Range .....	-40°C to 125°C

**RECOMMENDED OPERATING CONDITIONS**

This module has been designed to operate over a wide range of input and output conditions. However, best efficiency and performance will be obtained if the module is operated under the condition listed in the 'R.C.' Column. Min. and Max. columns indicate values beyond which the inverter, although operational, will not function optimally.

Parameter	Symbol	Recommended Operating Conditions			Units
		Min	R.C.	Max	
$V_{IN}$ Voltage Range	$V_{IN}$	9.0	12	16.0	V
Output Power	$P_O$			6.0	W
Brightness Control Input Voltage Range	$V_{BRT\_ADJ}$	0.0		5.0	V
BOOST Control Input Voltage Range	$V_{BST\_ADJ}$	0.0	1.5	5.0	V
Lamp Operating Voltage	$V_{LAMP}$	500		1000	V <sub>RMS</sub>
Lamp Current Full Brightness	$I_{OLAMP}$	3.5		9.0	mA <sub>RMS</sub>
Operating Ambient Temperature Range	$T_A$	-40		85	°C

**ELECTRICAL CHARACTERISTICS**

Unless otherwise specified, these specifications apply over the recommended operating conditions and  $T_A = -40$  to  $85^\circ\text{C}$  ambient temperature for the LXM1614E-14-11.

Parameter	Symbol	Test Conditions	LXM1614E-14-11			Units
			Min	Typ	Max	
<b>▶ OUTPUT PIN CHARACTERISTICS</b>						
Lamp Current, Full Boost	$I_{L(\text{BOOST5})}$	$V_{\text{IN}}=9\text{V}$ , BRITE= 5V, BOOST= 5V, $T_A$ per Figure 9	8	8.8	9.4	$\text{mA}_{\text{RMS}}$
Lamp Current, Full Boost	$I_{L(\text{BOOST1.5})}$	$V_{\text{IN}}=9\text{V}$ , BRITE= 5V, BOOST= 1.5V, $T_A$ per Figure 9	5	5.7	6.4	$\text{mA}_{\text{RMS}}$
Lamp Current, No Boost	$I_{L(\text{BOOST0})}$	$V_{\text{IN}}=9\text{V}$ , BRITE= 5V, BOOST= 0V, $T_A$ per Figure 9	3	3.8	4.6	$\text{mA}_{\text{RMS}}$
Min. Average Lamp Current (Note 2)	$I_{L(\text{MIN})}$	BRITE = BOOST = 0V		.12		$\text{mA}_{\text{RMS}}$
Lamp Start Voltage	$V_{\text{LS}}$				2000	$\text{V}_{\text{RMS}}$
Operating Frequency	$F_{\text{O}}$	BRITE= 5V	55	65	75	KHz
Fault Timeout	$T_{\text{FAULT}}$			1.0		SEC
<b>▶ BRITE INPUT</b>						
Linear Dim Control Range	$V_{\text{BRT}}$		0.5		4.5	$\text{V}_{\text{DC}}$
Input Current	$I_{\text{BRT}}$	BRITE= 0V BRITE= 5V		10		$\mu\text{A}_{\text{DC}}$
Input Voltage for Max. Lamp Current	$V_{\text{BRT\_ADJ}}$	$I_{\text{O(LAMP)}} = 100\%$ Duty Cycle	4.5		5.0	$\text{V}_{\text{DC}}$
Input Voltage for Min. Lamp Current	$V_{\text{BRT\_ADJ}}$	$I_{\text{O(LAMP)}} = \text{Minimum Duty Cycle}$	0		0.5	$\text{V}_{\text{DC}}$
<b>▶ BOOST INPUT</b>						
Linear Dim Control Range	$V_{\text{BST}}$		0.5		4.5	$\text{V}_{\text{DC}}$
Input Current	$I_{\text{BOOST}}$	BOOST= 0V BOOST= 5V		10		$\mu\text{A}_{\text{DC}}$
Input Voltage for Max. Boost Current	$V_{\text{BST\_ADJ}}$		4.5		5.0	$\text{V}_{\text{DC}}$
Input Voltage for Min. Boost Current	$V_{\text{BST\_ADJ}}$		0		0.5	$\text{V}_{\text{DC}}$
<b>▶ SLEEP INPUT</b>						
RUN Mode	$V_{\text{SLEEP}}$		2.4		$V_{\text{IN}}$	$\text{V}_{\text{DC}}$
OFF Mode	$V_{\text{SLEEP}}$		0		0.8	$\text{V}_{\text{DC}}$
Input Current	$I_{\text{SLEEP}}$	SLEEP=5V SLEEP=0V		110		$\mu\text{A}$
				0		
<b>▶ VSYNC CHARACTERISTICS</b>						
Logic High Level	$V_{\text{SYNC (HI)}}$		2.4		5.5	$\text{V}_{\text{DC}}$
Logic Low Level	$V_{\text{SYNC (LO)}}$		-0.3		0.8	$\text{V}_{\text{DC}}$
Input Impedance	$Z_{\text{IN}}$			10		$\text{K}\Omega$
Input Frequency	$F_{\text{VSYNC}}$	Minimum pulse width >1 $\mu\text{s}$	50		120	Hz
Output Burst Rate	$F_{\text{BURST}}$	$V_{\text{SYNC}}=0\text{V}$ , Free Run Frequency	135	170	195	Hz

Note 2: Minimum lamp current required to maintain even light output may vary with display panel.  
Average RMS current = (burst duty cycle) X (burst amplitude of full lamp current)

**FUNCTIONAL PIN DESCRIPTION**

Conn.	Pin	Description
<b>CN1 (Molex 53261-0890)*</b>		
CN1-1,2	V <sub>IN</sub>	Main Input Power Supply (9V to 16V)
CN1-3,4	GND	Power Supply Return
CN1-5	SLEEP	≥ 2.4V (Backlight on), ≤ 0.8V (Backlight off), I <sub>SLEEP</sub> =110μA @ 5.0V
CN1-6	BOOST	Lamp Current Amplitude Control (0.5-4.5VDC) 4.5VDC gives maximum boost
CN1-7	BRITE	Brightness Control (0.5- 4.5VDC) 4.5VDC gives maximum lamp current
CN1-8	V <sub>SYNC</sub>	Vertical Synchronization Input (50 < f <sub>SYNC</sub> < 120Hz), minimum pulse width 10μS
<b>CN2 (JST SM02(8.0)B-BHS-1-TB)</b>		
CN2-1	V <sub>OUT1</sub>	High Voltage CCFL Lamp Supply
CN2-2	V <sub>OUT2</sub>	High Voltage CCFL Lamp Return

\* LX9501 Mating Connector Assembly Available

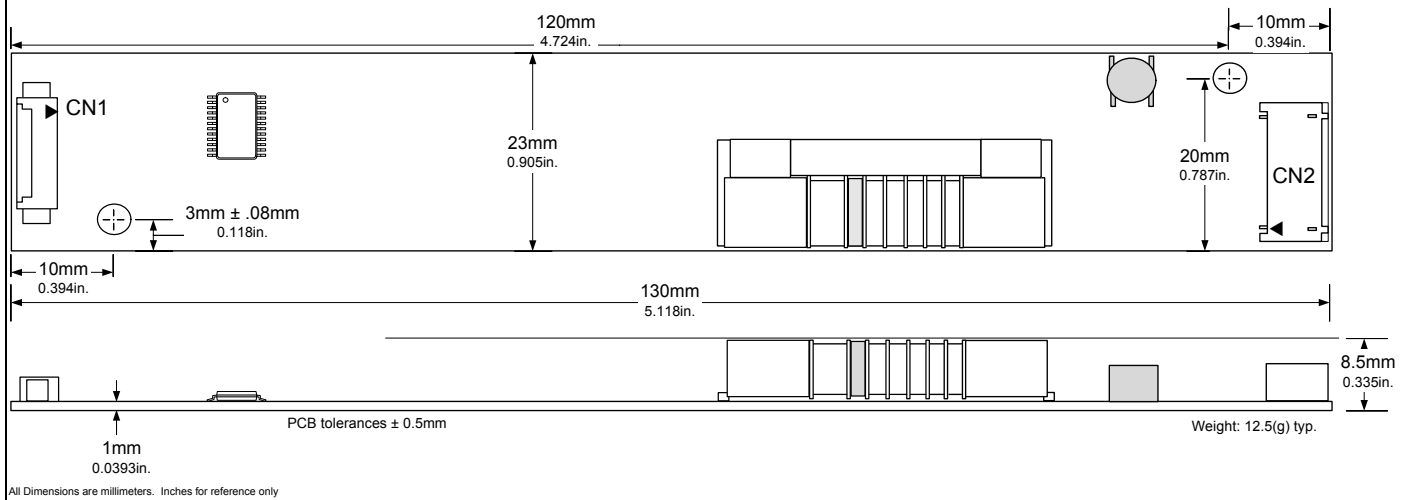
**PHYSICAL DIMENSIONS**

**HOW THE RANGEMAX WORKS**

Figure 1 – RangeMAX Simplified Block Diagram

**HIGHLIGHTS**

- Integrated dual brightness control circuit includes a DC voltage to pulse width converter that minimizes system design work and system noise susceptibility. This provides a familiar and convenient interface while reducing the potential for externally induced noise, which can cause lamp flicker.
- RangeMAX inverter modules are designed to operate with the burst frequency synchronized to the video frame rate. This provides operation with no visible display disturbances caused by beat frequencies between the lamps and video frame rates. In this synchronous mode, the inverter burst rate operates at twice the video refresh rate, well beyond standard 50/60Hz video refresh rates where the eye can perceive pulsing light. The frequency at the  $V_{\text{SYNC}}$  input will affect the minimum dimming level. Generally, the potential dimming (or brightness) range is inversely proportional to the  $V_{\text{SYNC}}$  frequency.
- In applications with no access to a vertical sync, an onboard oscillator operates the inverter burst rate at about 170Hz. In this non-synchronous mode, minor display disturbances can be found under certain video conditions. This performance may be acceptable for many applications, but synchronization must be used when no disturbance can be tolerated.
- Separate feedback loops for lamp current and open circuit voltage regulation insure reliable strike under all operating conditions, automatic over-voltage prevention with broken or failed lamps, and accurate lamp current regulation.
- A single input will accommodate negative and positive vertical sync pulses at any pulse width.

**HOW THE RANGEMAX WORKS (CONTINUED)**
**LAMP VOLTAGE & LAMP CURRENT – BURST MODE OPERATION**

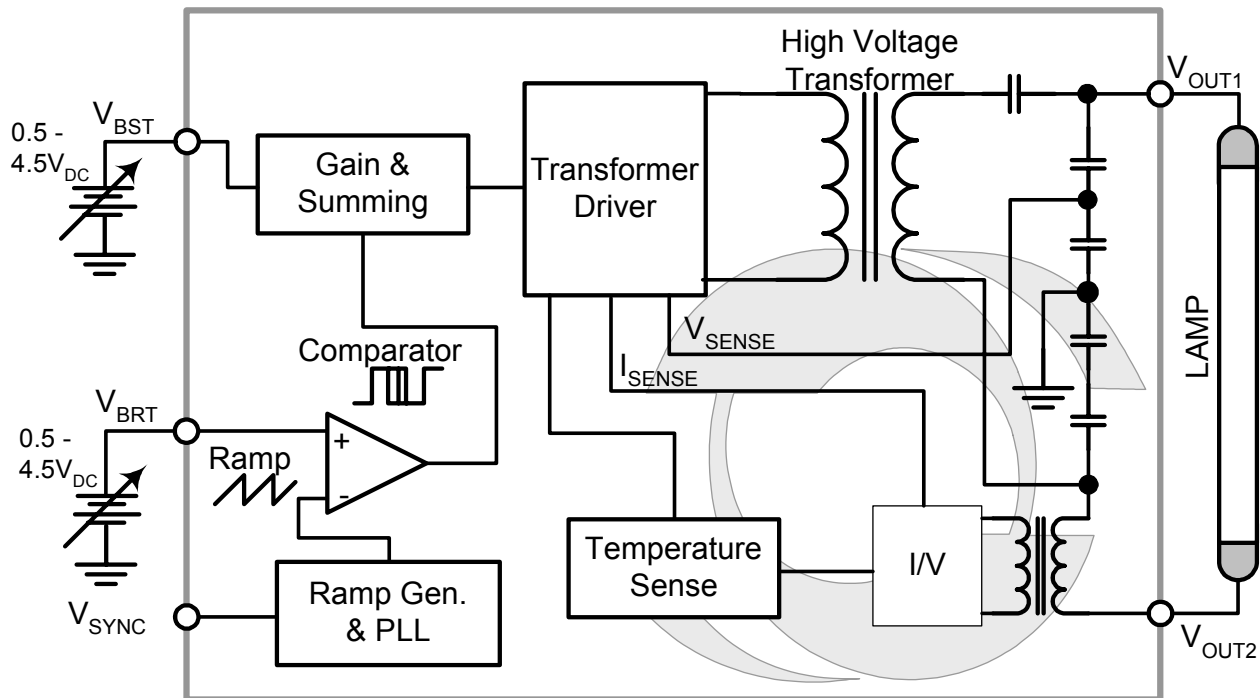
Figure 2 – LXM1614E Combines Current Amplitude and Digital Techniques

The LXM1614E provides both lamp current amplitude control (BOOST) and a brightness control (BRITE) for dimming. Please see following sections for dimming and amplitude boost control. To achieve extremely wide dimming ranges, rather than only using the traditional dimming technique of varying lamp current magnitude to adjust light output, RangeMAX inverters utilize a fixed lamp current value with a duty cycle control method.

The lamp current burst width can be modulated from 100% (continuous lamp current) down to a 2% duty cycle, allowing the lamp to be dimmed to less than 2% of its full brightness.

As can be seen in Trace 4 of Figure 5, careful design consideration was given to controlling lamp start voltage to softly start current flow. This eliminates current overshoot that can result in premature cathode wear and reduce lamp life.

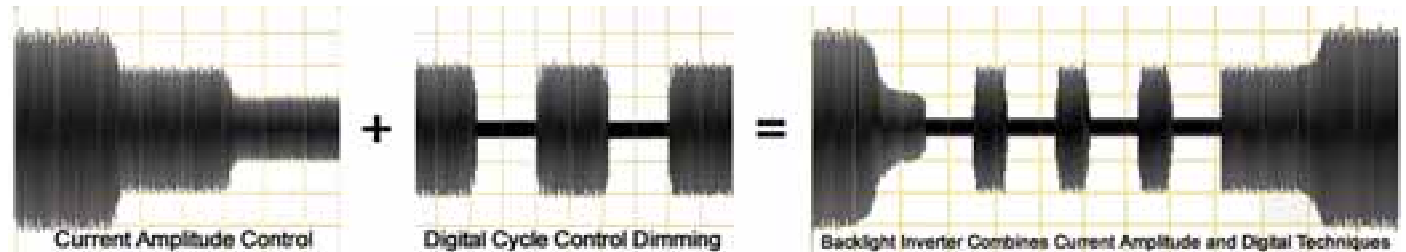
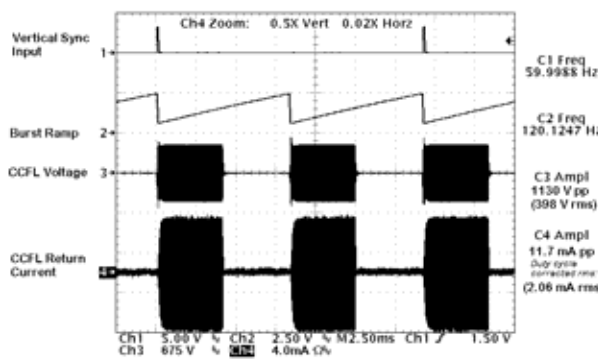

Figure 3 – 50% Burst Duty Cycle

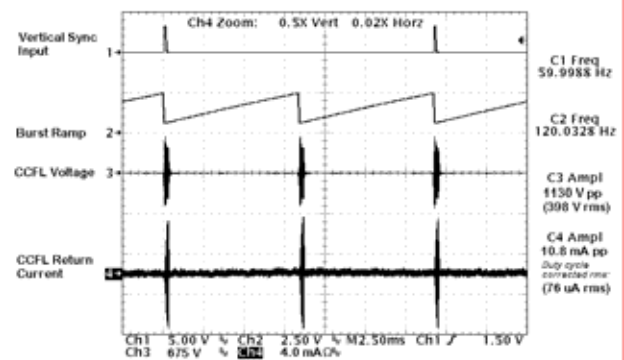

Figure 4 – 2% Burst Duty Cycle

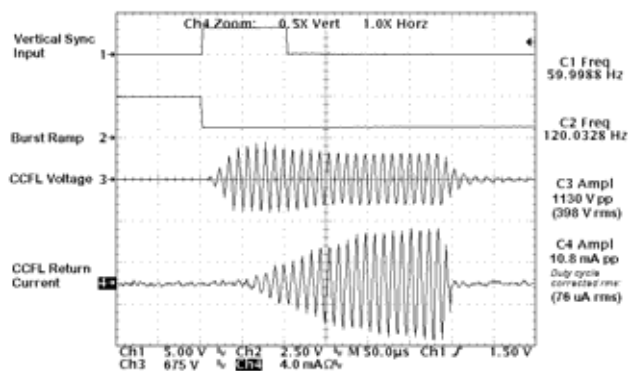

Figure 5 – 2% Burst Duty Cycle (Expanded Time Base)



**HOW THE RANGEMAX WORKS (CONTINUED)**
**DUAL DIMMING CAPABILITY**

As seen in the Brightness vs. Time graphs, the boost mode operation can improve the performance of cold cathode fluorescent lamps in any LCD application by reducing the time it takes to warm up lamps to their optimum operating temperature. This feature is helpful in large LCD multi-lamp monitors as well as automotive or industrial extreme temperature applications.

The “boost” control provides a timed overdrive mode to maximize light output over temperature. After a panel is characterized with a profile of the user’s application (such as desired light output as a function of ambient light and temperature), the appropriate boost level, and duration of the boost can be set. Further wide range dimming control is provided by the Brite input dimming function.

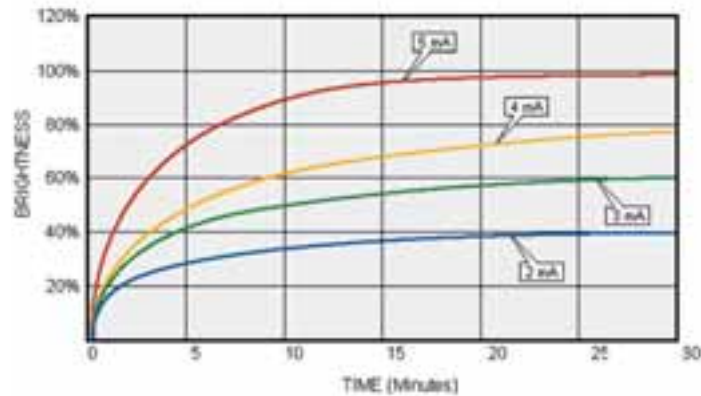
**Standard 12.1" LCD Display**

Testing was performed with display in 25°C environment

Figure 6 -

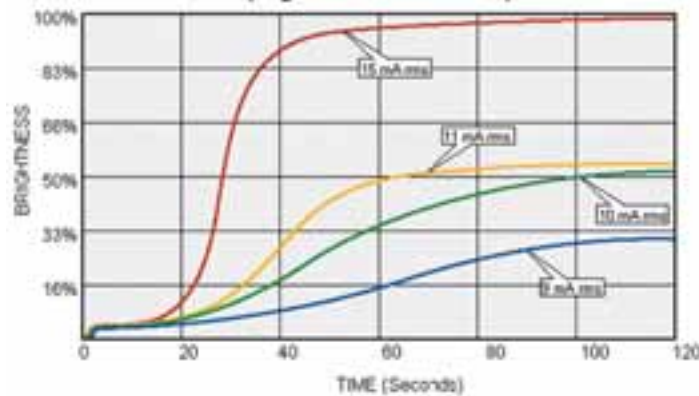
**5.8" Self Heating Display  
(High Pressure CCFL)**

Testing was performed with display in -40°C environment

Figure 7 -

**HOW THE RANGEMAX WORKS (CONTINUED)**
**WIDE RANGE DIMMING FUNCTION**

Dimming can be controlled by a DC voltage (like a voltage output DAC) or by a PWM signal (5V logic level PWM signal from a micro controller). The PWM signal should be 400Hz to 4kHz, 0V to 5V, 0% to 100% duty cycle.

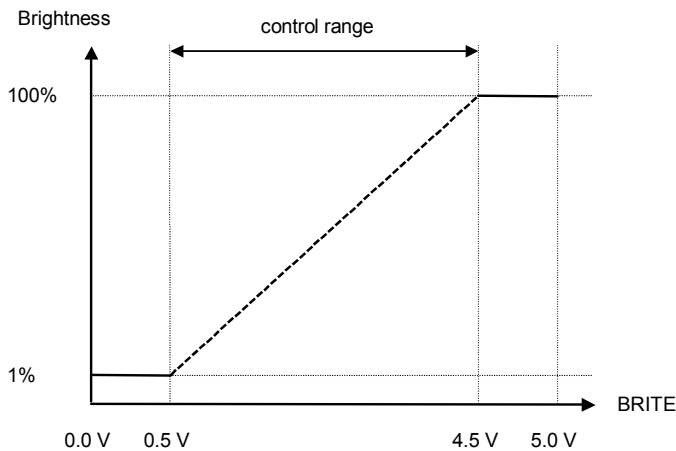

Figure 8 – Typical brightness as a function of the BRITE control (CN1-7)

**AMPLITUDE BOOST FUNCTION**

The Boost Function Control signal levels are the same as the Dimming Control. Less than 0.5V provides 4mA maximum lamp current while 4.5V on Boost provides “max boost” with a max lamp current of 9mA. Please note that these maximum lamp current levels are protected by the on-board thermistor, which limits the maximum lamp current automatically as a function of temperature as seen in Figure 9.

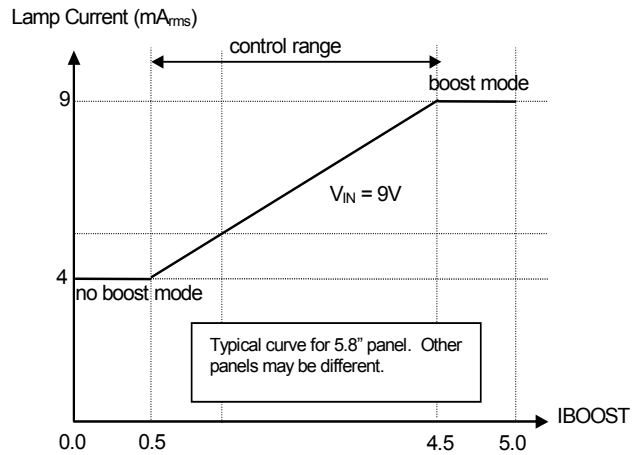

Figure 9 – Typical maximum lamp current as a function of the Boost control (CN1-6)

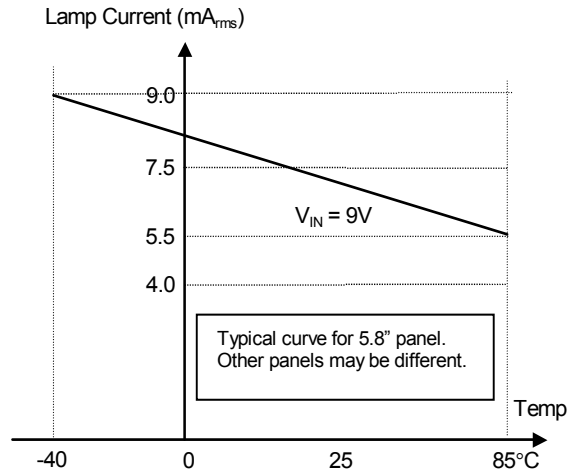
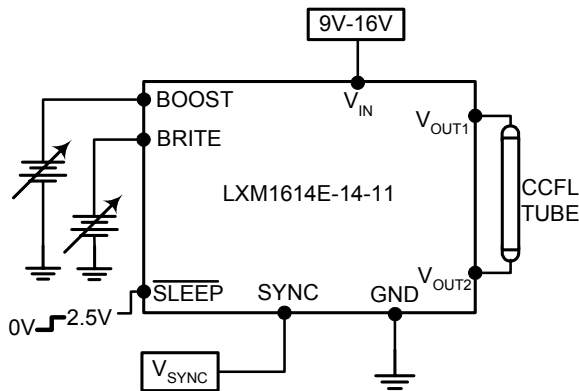
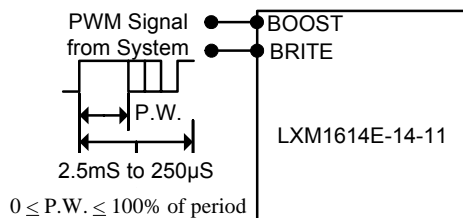

Figure 10 – Typical maximum lamp current as a function of ambient temperature



**TYPICAL APPLICATION**

**Figure 11 - Brightness Control**

**Figure 12 - PWM Brightness Control**

- The BRITE/BOOST control may be a voltage output DAC, or other voltage source as shown in Figure 11. A 5V Logic Level PWM signal from a micro-controller may also be used as shown in Figure 12.
- If synchronization to the video frame rate is desired, connect the vertical sync pulse from the system video controller to the  $V_{SYNC}$  input. If no video synchronization is desired, connect  $V_{SYNC}$  to ground.
- If you need to turn the inverter ON/OFF remotely, connect a 2.4V to 5V logic signal to the SLEEP input. If remote ON/OFF is not needed, connect the SLEEP input to  $V_{IN}$  or other voltage source between 2.4V and 5V.
- Connect  $V_{OUT1}$  to the high voltage supply wire from the lamp. Connect  $V_{OUT2}$  to the high voltage return wire from the lamp.

**RangeMAX INVERTERS**

Also available in other wide range dimming single lamp inverters LXM1612-xx-xx, LXM1615-03-xx, LXM1617/8-xx-xx, Dual Output, LXM1623/4-xx-xx, LXM1626-xx-xx, and Quad Output LXM1643-12-6x versions for multiple lamp applications. See the Microsemi website [www.microsemi.com](http://www.microsemi.com) for a current list of available inverters products.

PRELIMINARY DATA – Information contained in this document is pre-production data and is proprietary to Microsemi. It may not be modified in any way without the express written consent of Microsemi. Product referred to herein is offered in pre-production form only and may not have completed Microsemi's Quality Assurance process for Release to Production. Microsemi reserves the right to change or discontinue this proposed product at any time.