

**LED55B**

**LED55C**

**LED56**

**PACKAGE DIMENSIONS**

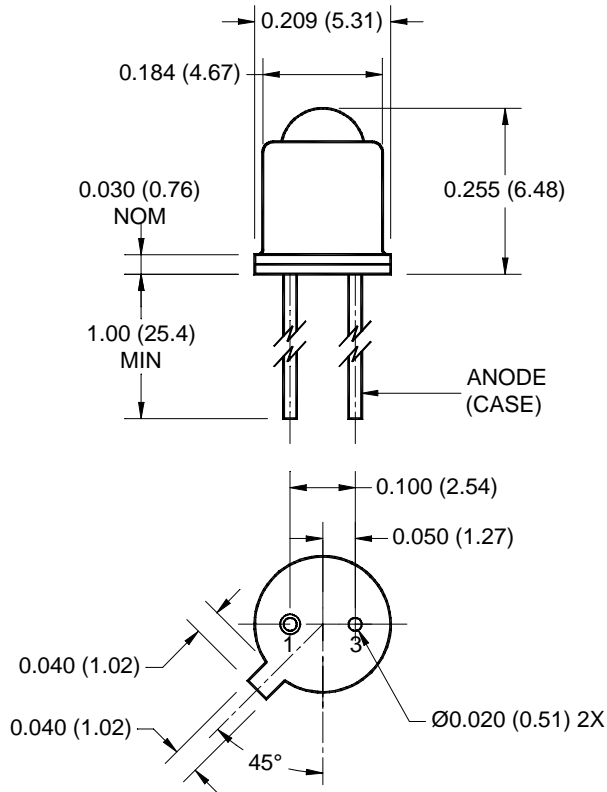

**NOTES:**

1. Dimensions for all drawings are in inches (mm).
2. Tolerance of  $\pm .010$  (.25) on all non-nominal dimensions unless otherwise specified.

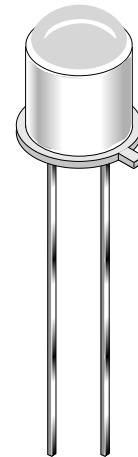

**SCHEMATIC**

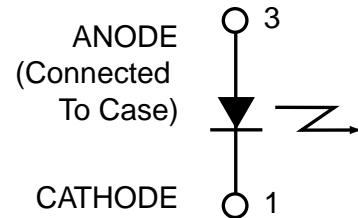

**DESCRIPTION**

The LED55B/LED55C/LED56 are 940 nm LEDs in a narrow angle, TO-46 package.

**FEATURES**

- Good optical to mechanical alignment
- Mechanically and wavelength matched to the TO-18 series phototransistor
- Hermetically sealed package
- High irradiance level

## LED55B

## LED55C

## LED56

### ABSOLUTE MAXIMUM RATINGS (T<sub>A</sub> = 25°C unless otherwise specified)

Parameter	Symbol	Rating	Unit
Operating Temperature	T <sub>OPR</sub>	-65 to +125	°C
Storage Temperature	T <sub>STG</sub>	-65 to +150	°C
Soldering Temperature (Iron) <sup>(3,4,5 and 6)</sup>	T <sub>SOL-I</sub>	240 for 5 sec	°C
Soldering Temperature (Flow) <sup>(3,4 and 6)</sup>	T <sub>SOL-F</sub>	260 for 10 sec	°C
Continuous Forward Current	I <sub>F</sub>	100	mA
Forward Current (pw, 1µs; 200Hz)	I <sub>F</sub>	10	A
Reverse Voltage	V <sub>R</sub>	3	V
Power Dissipation (T <sub>A</sub> = 25°C) <sup>(1)</sup>	P <sub>D</sub>	170	mW
Power Dissipation (T <sub>C</sub> = 25°C) <sup>(2)</sup>	P <sub>D</sub>	1.3	W

#### NOTE:

1. Derate power dissipation linearly 1.70 mW/°C above 25°C ambient.
2. Derate power dissipation linearly 13.0 mW/°C above 25°C case.
3. RMA flux is recommended.
4. Methanol or isopropyl alcohols are recommended as cleaning agents.
5. Soldering iron tip 1/16" (1.6mm) minimum from housing.
6. As long as leads are not under any stress or spring tension
7. Total power output, P<sub>O</sub>, is the total power radiated by the device into a solid angle of 2 π steradians.

### ELECTRICAL / OPTICAL CHARACTERISTICS (T<sub>A</sub> = 25°C) (All measurements made under pulse conditions)

PARAMETER	TEST CONDITIONS	SYMBOL	MIN	TYP	MAX	UNITS
Peak Emission Wavelength	I <sub>F</sub> = 100 mA	λ <sub>P</sub>	—	940	—	nm
Emission Angle at 1/2 Power	I <sub>F</sub> = 100 mA	θ	—	±8	—	Deg.
Forward Voltage	I <sub>F</sub> = 100 mA	V <sub>F</sub>	—	—	1.7	V
Reverse Leakage Current	V <sub>R</sub> = 3 V	I <sub>R</sub>	—	—	10	µA
Total Power LED55B <sup>(7)</sup>	I <sub>F</sub> = 100 mA	P <sub>O</sub>	3.5	—	—	mW
Total Power LED55C <sup>(7)</sup>	I <sub>F</sub> = 100 mA	P <sub>O</sub>	5.4	—	—	mW
Total Power LED56 <sup>(7)</sup>	I <sub>F</sub> = 100 mA	P <sub>O</sub>	1.5	—	—	mW
Rise Time 0-90% of output		t <sub>r</sub>	—	1.0	—	µs
Fall Time 100-10% of output		t <sub>f</sub>	—	1.0	—	µs

**TYPICAL PERFORMANCE CURVES**

**Figure 1. Power Output vs. Input Current**

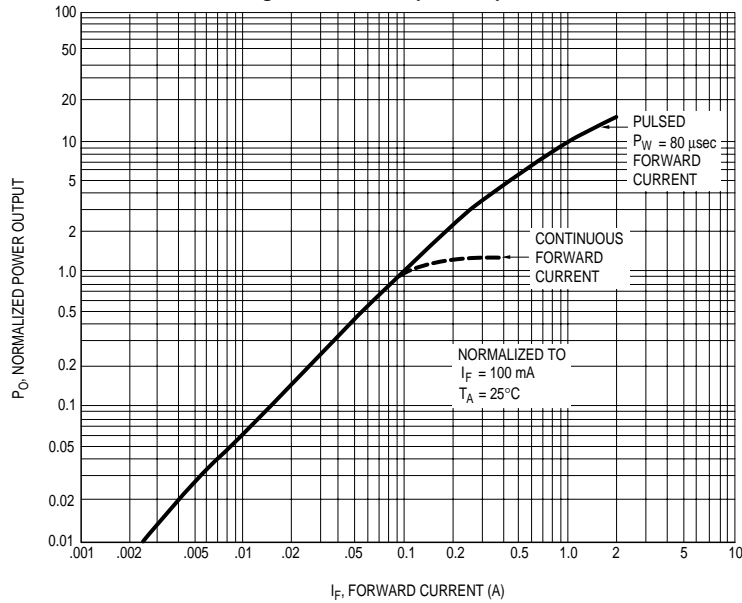

**Figure 2. Power Output vs. Temperature**

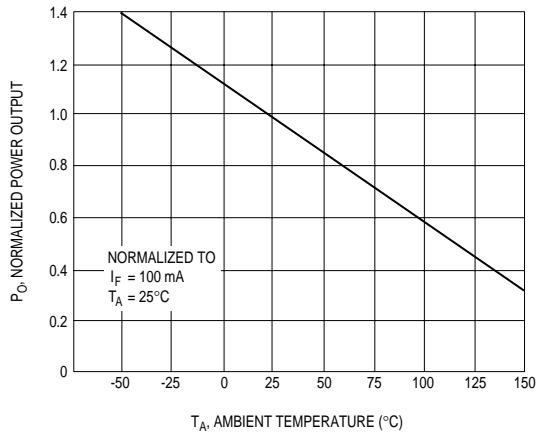

**Figure 3. Forward Voltage vs. Forward Current**

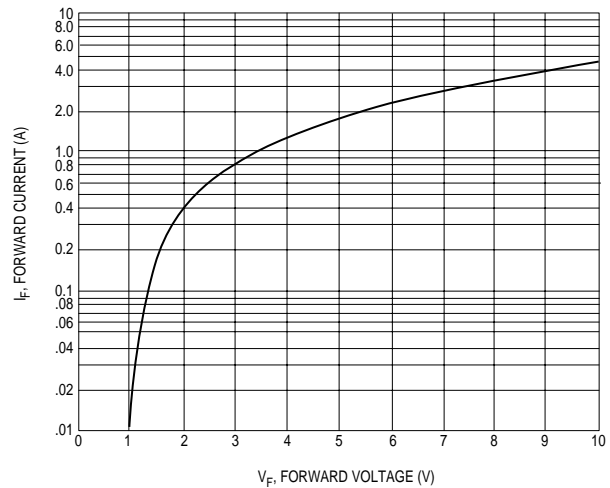

**Figure 4. Forward Voltage vs. Forward Current**

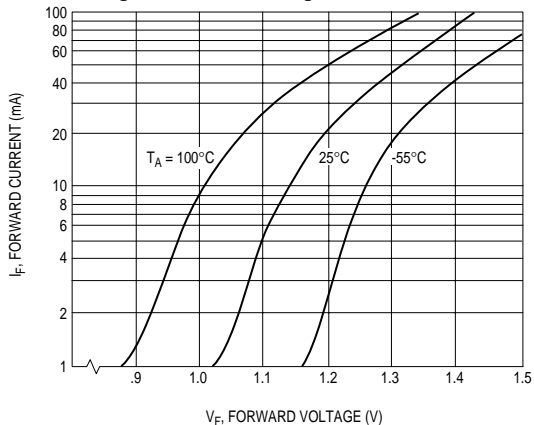

**Figure 5. Typical Radiation Pattern**

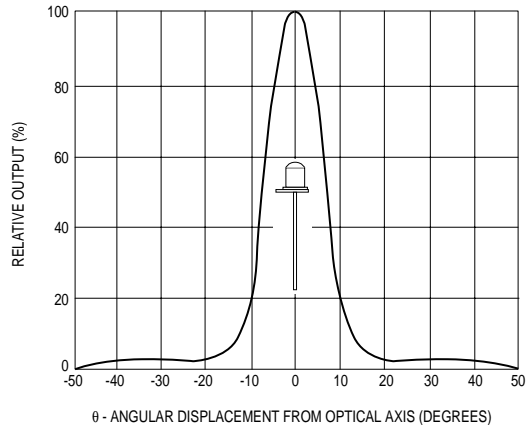

---

**LED55B**

**LED55C**

**LED56**

---

## **DISCLAIMER**

FAIRCHILD SEMICONDUCTOR RESERVES THE RIGHT TO MAKE CHANGES WITHOUT FURTHER NOTICE TO ANY PRODUCTS HEREIN TO IMPROVE RELIABILITY, FUNCTION OR DESIGN. FAIRCHILD DOES NOT ASSUME ANY LIABILITY ARISING OUT OF THE APPLICATION OR USE OF ANY PRODUCT OR CIRCUIT DESCRIBED HEREIN; NEITHER DOES IT CONVEY ANY LICENSE UNDER ITS PATENT RIGHTS, NOR THE RIGHTS OF OTHERS.

## **LIFE SUPPORT POLICY**

FAIRCHILD'S PRODUCTS ARE NOT AUTHORIZED FOR USE AS CRITICAL COMPONENTS IN LIFE SUPPORT DEVICES OR SYSTEMS WITHOUT THE EXPRESS WRITTEN APPROVAL OF THE PRESIDENT OF FAIRCHILD SEMICONDUCTOR CORPORATION. As used herein:

1. Life support devices or systems are devices or systems which, (a) are intended for surgical implant into the body, or (b) support or sustain life, and (c) whose failure to perform when properly used in accordance with instructions for use provided in labeling, can be reasonably expected to result in a significant injury of the user.
2. A critical component in any component of a life support device or system whose failure to perform can be reasonably expected to cause the failure of the life support device or system, or to affect its safety or effectiveness.