

**Rote Lumineszenzdiode**  
**Red Emitter**  
**Lead (Pb) Free Product - RoHS Compliant**

**SFH 4273**



**Wesentliche Merkmale**

- Schwarz eingefärbtes TOPLED-Gehäuse
- Typische Emissionswellenlänge 660nm
- Verbesserte Abbildungseigenschaften durch Absorption der Seitenstrahlung
- Größe der Leuchtquelle 325 µm x 325 µm
- Feuchte-Empfindlichkeitsstufe 2 nach JEDEC Standard J-STD-020C

**Anwendungen**

- Miniaturlichtschranken und Lichtschranken über große Entfernungen
- Industrieelektronik
- „Messen/Steuern/Regeln“
- Sensorik
- Alarm- und Sicherungssysteme

**Features**

- Black colored TOPLED-package
- Typical peak wavelength 660nm
- Improved imaging characteristics due to absorption of side emission
- Size of emitting area 325µm x 325µm
- Moisture sensitivity level 2 according to JEDEC Standard J-STD-020C

**Applications**

- Miniature and long distance photointerrupters
- Industrial electronics
- For drive and control circuits
- Sensor technology
- Alarm and safety equipment

Typ Type	Bestellnummer Ordering Code	Strahlstärkegruppierung <sup>1)</sup> ( $I_F = 50 \text{ mA}$ , $t_p = 20 \text{ ms}$ ) Radiant Intensity Grouping <sup>1)</sup> $I_e \text{ (mW/sr)}$
SFH 4273	Q65110A2523	> 0.63 (typ. 1.0)

<sup>1)</sup> gemessen bei einem Raumwinkel  $\Omega = 0.01 \text{ sr}$  / measured at a solid angle of  $\Omega = 0.01 \text{ sr}$

Achtung: Es wird empfohlen, das Bauteil nicht bei extremer Luftfeuchtigkeit zu betreiben. Ist dies dennoch vorgesehen, setzen Sie sich bitte mit OSRAM OS in Verbindung

Attention: It is recommended not to operate the device under extreme humidity. If this is designated though, please contact OSRAM OS.

Grenzwerte ( $T_A = 25\text{ °C}$ )

## Maximum Ratings

Bezeichnung Parameter	Symbol Symbol	Wert Value	Einheit Unit
Betriebs- und Lagertemperatur Operating and storage temperature range	$T_{op}; T_{stg}$	- 40 ... + 100	°C
Sperrspannung Reverse voltage	$V_R$	3	V
Durchlassstrom Forward current	$I_F$	50	mA
Stoßstrom, $\tau = 10\ \mu\text{s}$ , $D = 0$ Surge current	$I_{FSM}$	1	A
Verlustleistung Power dissipation	$P_{tot}$	125	mW
Wärmewiderstand Sperrschicht - Umgebung bei Montage auf FR4 Platine, Padgröße je $16\ \text{mm}^2$ Thermal resistance junction - ambient mounted on PC-board (FR4), padsize $16\ \text{mm}^2$ each	$R_{thJA}$	450	K/W
Wärmewiderstand Sperrschicht - Lötstelle bei Montage auf Metall-Block Thermal resistance junction - soldering point, mounted on metal block	$R_{thJS}$	$\approx 200$	K/W

Kennwerte ( $T_A = 25\text{ °C}$ )

## Characteristics

Bezeichnung Parameter	Symbol Symbol	Wert Value	Einheit Unit
Wellenlänge der Strahlung Wavelength at peak emission $I_F = 50\text{ mA}$ , $t_p = 20\text{ ms}$	$\lambda_{\text{peak}}$	660	nm
Spektrale Bandbreite bei 50% von $I_{\text{max}}$ Spectral bandwidth at 50% of $I_{\text{max}}$ $I_F = 50\text{ mA}$	$\Delta\lambda$	25	nm
Abstrahlwinkel Half angle	$\varphi$	$\pm 60$	Grad deg.
Aktive Chipfläche Active chip area	$A$	0.106	mm <sup>2</sup>
Abmessungen der aktiven Chipfläche Dimensions of the active chip area	$L \times B$ $L \times W$	$0.325 \times 0.325$	mm <sup>2</sup>
Schaltzeiten, $I_e$ von 10% auf 90% und von 90% auf 10%, bei $I_F = 50\text{ mA}$ , $R_L = 50\ \Omega$ Switching times, $I_e$ from 10% to 90% and from 90% to 10%, $I_F = 50\text{ mA}$ , $R_L = 50\ \Omega$	$t_r$ , $t_f$	100	ns
Kapazität Capacitance $V_R = 0\text{ V}$ , $f = 1\text{ MHz}$	$C_o$	30	pF
Durchlassspannung Forward voltage $I_F = 50\text{ mA}$ , $t_p = 20\text{ ms}$	$V_F$	2.1 ( $\leq 2.8$ )	V
Sperrstrom, Reverse curr50mA50 mAent $V_R = 5\text{ V}$	$I_R$	0.01 ( $\leq 1$ )	$\mu\text{A}$
Gesamtstrahlungsfluss Total radiant flux $I_F = 50\text{ mA}$ , $t_p = 20\text{ ms}$	$\Phi_e$	5	mW
Temperaturkoeffizient von $I_e$ bzw. $\Phi_e$ , $I_F = 50\text{ mA}$ Temperature coefficient of $I_e$ or $\Phi_e$ , $I_F = 50\text{ mA}$	$TC_I$	- 0.4	%/K
Temperaturkoeffizient von $V_F$ , $I_F = 50\text{ mA}$ Temperature coefficient of $V_F$ , $I_F = 50\text{ mA}$	$TC_V$	- 3	mV/K
Temperaturkoeffizient von $\lambda$ , $I_F = 50\text{ mA}$ Temperature coefficient of $\lambda$ , $I_F = 50\text{ mA}$	$TC_\lambda$	+ 0.16	nm/K

**Strahlstärke  $I_e$  in Achsrichtung**gemessen bei einem Raumwinkel  $\Omega = 0.01$  sr**Radiant Intensity  $I_e$  in Axial Direction**at a solid angle of  $\Omega = 0.01$  sr

Bezeichnung Parameter	Symbol	Werte Values	Einheit Unit
Strahlstärke Radiant intensity $I_F = 50$ mA, $t_p = 20$ ms	$I_e$	> 0.63 (typ. 1.0)	mW/sr

**Relative Spectral Emission**

$I_{rel} = f(\lambda)$

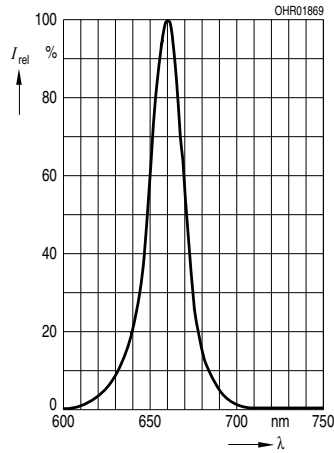

**Radiant Intensity**

$I_e / I_{e(50mA)} = f(I_F)$   
Single pulse,  $t_p = 20 \mu s$

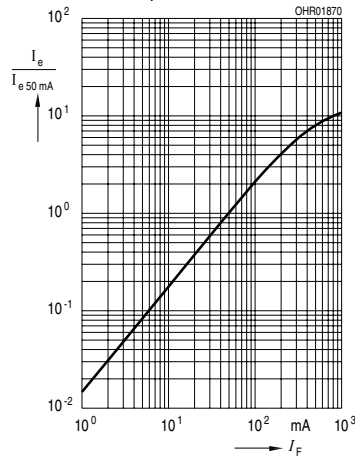

**Max. Permissible Forward Current**

$I_F = f(T_A)$

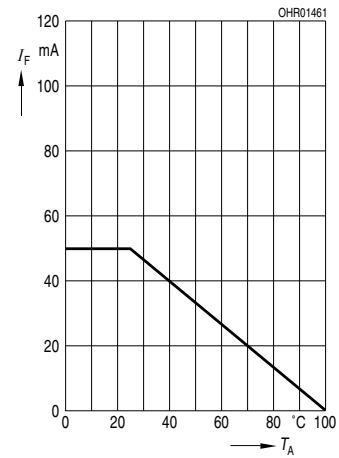

**Forward Current**

$I_F = f(V_F)$  single pulse,  $t_p = 20 \mu s$

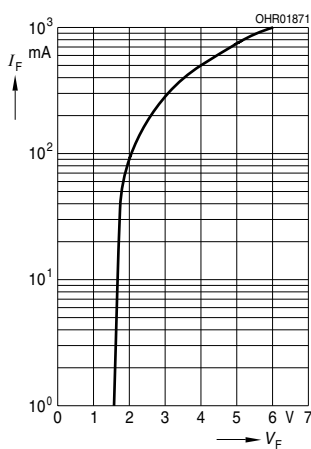

**Permissible Pulse Handling Capability**

$I_F = f(t_p)$ ,  $T_A = 25^\circ C$   
duty cycle  $D =$  parameter

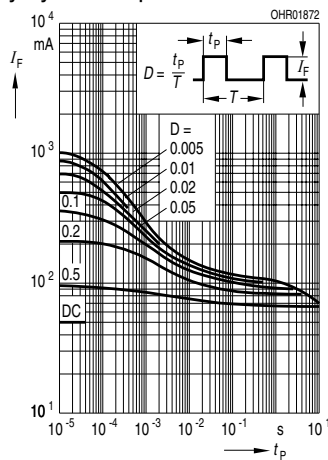

**Radiation Characteristics**

$I_{rel} = f(\varphi)$

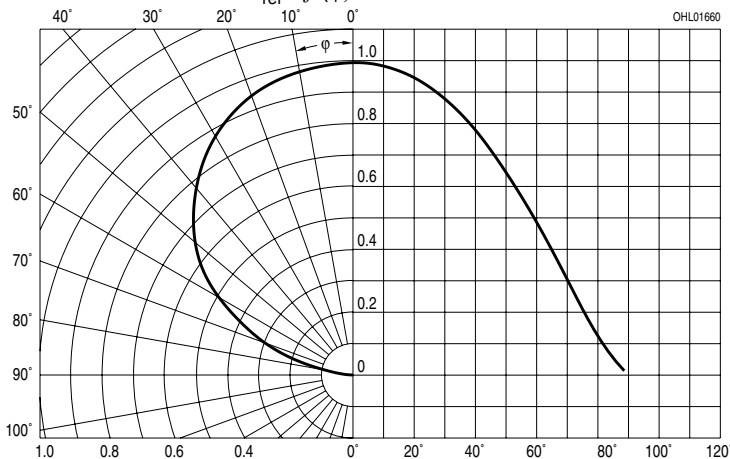

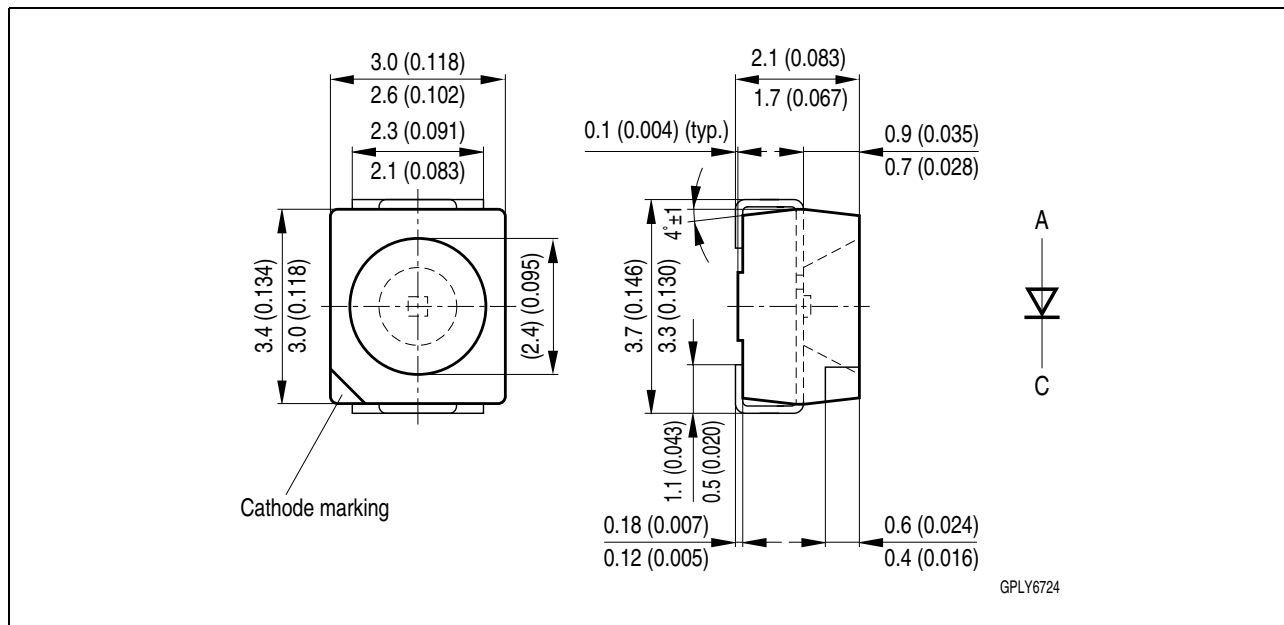
**Maßzeichnung**  
**Package Outlines**

Maße in mm (inch) / Dimensions in mm (inch).

Gehäuse / Package	TOPLED®, klarer Verguss / TOPLED®, clear resin
Anschlussbelegung Pin configuration	abgeschrägte Ecke: Kathode beveled edge: Cathode
Farbe Color	schwarz black
Brechungsindex Verguss Refractive index resin	1.53 1.53

**Empfohlenes Lötpad-Design**  
**Recommended Solder Pad**

**Reflow Löten**  
**Reflow Soldering**

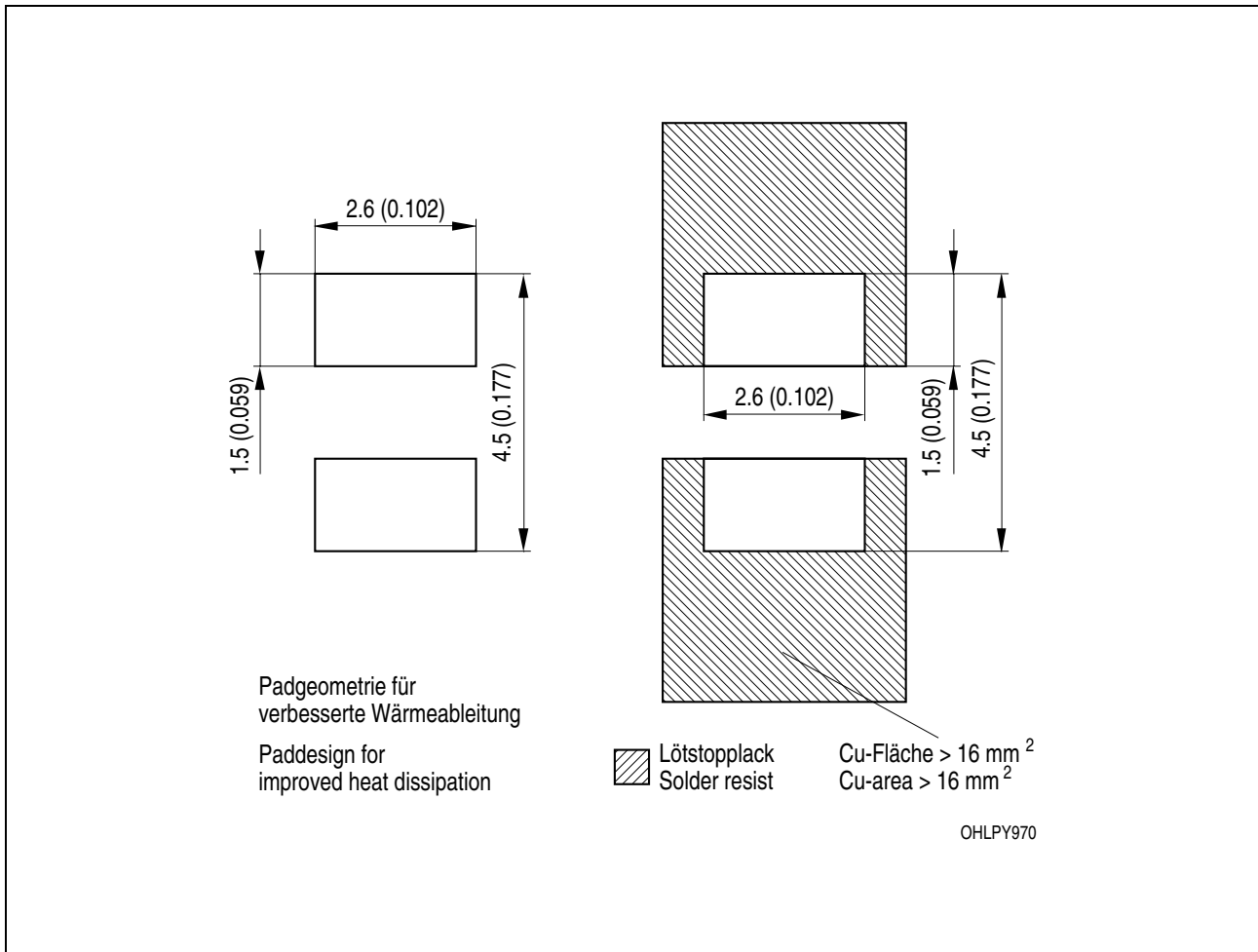

Maße in mm (inch) / Dimensions in mm (inch)

**Lötbedingungen**  
**Soldering Conditions**  
**Reflow Lötprofil für bleifreies Löt**  
**Reflow Soldering Profile for lead free soldering**

Vorbehandlung nach JEDEC Level 2  
 Preconditioning acc. to JEDEC Level 2  
 (nach J-STD-020C)  
 (acc. to J-STD-020C)

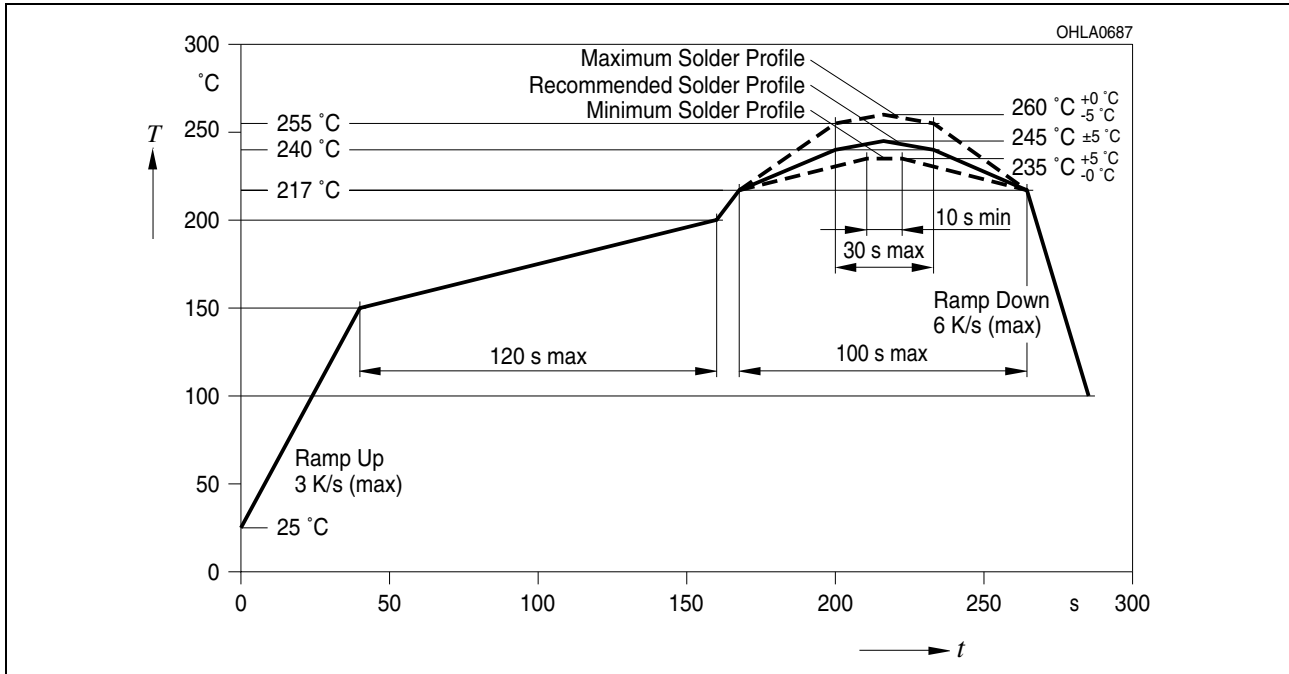

**Wellenlöten (TTW)**  
**TTW Soldering**

(nach CECC 00802)  
 (acc. to CECC 00802)

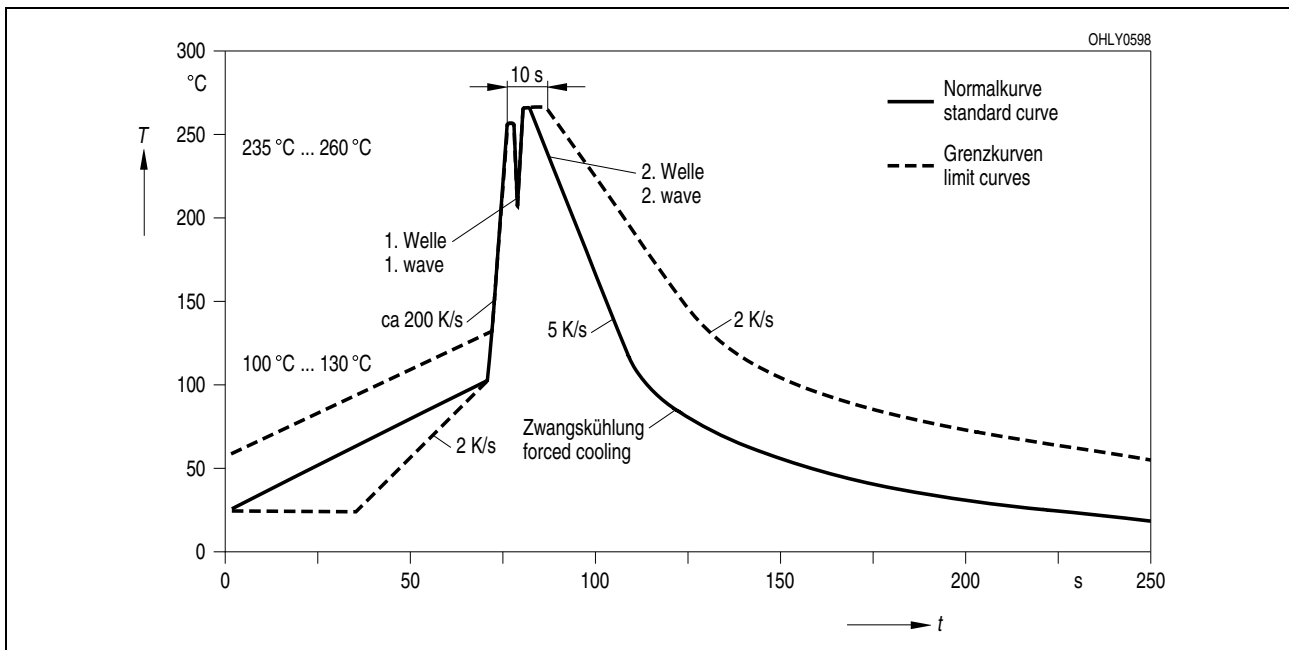



Published by  
**OSRAM Opto Semiconductors GmbH**  
Wernerwerkstrasse 2, D-93049 Regensburg  
[www.osram-os.com](http://www.osram-os.com)  
© All Rights Reserved.

EU RoHS and China RoHS compliant product



此产品符合欧盟 RoHS 指令的要求；  
按照中国的相关法规和标准，不含有毒有害物质或元素。

The information describes the type of component and shall not be considered as assured characteristics. Terms of delivery and rights to change design reserved. Due to technical requirements components may contain dangerous substances. For information on the types in question please contact our Sales Organization.

#### **Packing**

Please use the recycling operators known to you. We can also help you – get in touch with your nearest sales office. By agreement <sup>1</sup> we will take packing material back, if it is sorted. You must bear the costs of transport. For packing material that is returned to us unsorted or which we are not obliged to accept, we shall have to invoice you for any costs incurred.

**Components used in life-support devices or systems must be expressly authorized for such purpose!** Critical components <sup>1</sup>, may only be used in life-support devices or systems <sup>2</sup> with the express written approval of OSRAM OS.

<sup>1</sup> A critical component is a component used in a life-support device or system whose failure can reasonably be expected to cause the failure of that life-support device or system, or to affect its safety or effectiveness of that device or system.

<sup>2</sup> Life support devices or systems are intended (a) to be implanted in the human body, or (b) to support and/or maintain and sustain human life. If they fail, it is reasonable to assume that the health of the user may be endangered.