

IR-Lumineszenzdiode
Infrared Emitter
Lead (Pb) Free Product - RoHS Compliant

LD 271
LD 271 H
LD 271 L
LD 271 LH



Wesentliche Merkmale

- GaAs-LED in 5mm radial-Gehäuse
- Typische Peakwellenlänge 950nm
- Hohe Zuverlässigkeit
- Mit verschiedenen Beinchenlängen lieferbar
- Variante mit "stand-off" lieferbar
- TTW Löten geeignet

Anwendungen

- IR-Fernsteuerung von Fernseh- und Rundfunkgeräten, Videorecordern, Lichtdimmern
- Gerätefernsteuerungen für Gleich- und Wechsellichtbetrieb
- Sensorik
- Diskrete Lichtschranken

Features

- GaAs-LED in 5mm radial package (T 1^{3/4})
- Typical peak wavelength 950nm
- High reliability
- Available with two different lead lengths
- Version with stand-off available
- Suitable for TTW soldering

Applications

- IR remote control of hi-fi and TV-sets, video tape recorders, dimmers
- Remote control for steady and varying intensity
- Sensor technology
- Discrete interrupters

Typ Type	Bestellnummer Ordering Code	Strahlstärkegruppierung ¹⁾ ($I_F = 100\text{mA}$, $t_p = 20\text{ ms}$) Radiant intensity grouping ¹⁾ I_e (mW/sr)
LD 271	Q62703Q0148	15 (>10)
LD 271 L	Q62703Q0833	
LD 271 H	Q62703Q0256	>16
LD 271 LH	Q62703Q0838	

¹⁾ gemessen bei einem Raumwinkel $\Omega = 0.01\text{ sr}$
measured at a solid angle of $\Omega = 0.01\text{ sr}$

Grenzwerte
Maximum Ratings

Bezeichnung Parameter	Symbol Symbol	Wert Value	Einheit Unit
Betriebs- und Lagertemperatur Operating and storage temperature range	$T_{op}; T_{stg}$	- 40 ... + 100	°C
Sperrspannung Reverse voltage	V_R	5	V
Durchlaßstrom Forward current	I_F	130	mA
Stoßstrom, $t_p = 10 \mu s, D = 0$ Surge current	I_{FSM}	3.5	A
Verlustleistung Power dissipation	P_{tot}	220	mW
Wärmewiderstand Thermal resistance	R_{thJA}	330	K/W

Kennwerte ($T_A = 25 \text{ °C}$)
Characteristics

Bezeichnung Parameter	Symbol Symbol	Wert Value	Einheit Unit
Wellenlänge der Strahlung Wavelength at peak emission $I_F = 100 \text{ mA}, t_p = 20 \text{ ms}$	λ_{peak}	950	nm
Spektrale Bandbreite bei 50% von I_{max} Spectral bandwidth at 50% of I_{max} $I_F = 100 \text{ mA}$	$\Delta\lambda$	55	nm
Abstrahlwinkel Half angle	φ	± 25	Grad deg.
Aktive Chipfläche Active chip area	A	0.25	mm ²
Abmessungen der aktiven Chipfläche Dimensions of the active chip area	$L \times B$ $L \times W$	0.5×0.5	mm ²
Abstand Chipoberfläche bis Linsenscheitel Distance chip front to lens top	H	4.0 ... 4.6	mm
Schaltzeiten, I_e von 10% auf 90% und von 90% auf 10%, bei $I_F = 100 \text{ mA}, R_L = 50 \Omega$ Switching times, I_e from 10% to 90% and from 90% to 10%, $I_F = 100 \text{ mA}, R_L = 50 \Omega$	t_r, t_f	1	μs

Kennwerte ($T_A = 25\text{ °C}$)
Characteristics (cont'd)

Bezeichnung Parameter	Symbol Symbol	Wert Value	Einheit Unit
Kapazität, $V_R = 0\text{ V}$, $f = 1\text{ MHz}$ Capacitance	C_o	40	pF
Durchlaßspannung Forward voltage $I_F = 100\text{ mA}$, $t_p = 20\text{ ms}$ $I_F = 1\text{ A}$, $t_p = 100\text{ }\mu\text{s}$	V_F V_F	1.30 (≤ 1.5) 1.90 (≤ 2.5)	V V
Sperrstrom, $V_R = 5\text{ V}$ Reverse current	I_R	0.01 (≤ 1)	μA
Gesamtstrahlungsfluß Total radiant flux $I_F = 100\text{ mA}$, $t_p = 20\text{ ms}$	Φ_e	18	mW
Temperaturkoeffizient von I_e bzw. Φ_e , $I_F = 100\text{ mA}$ Temperature coefficient of I_e or Φ_e , $I_F = 100\text{ mA}$	TC_I	- 0.55	%/K
Temperaturkoeffizient von V_F , $I_F = 100\text{ mA}$ Temperature coefficient of V_F , $I_F = 100\text{ mA}$	TC_V	- 1.5	mV/K
Temperaturkoeffizient von λ , $I_F = 100\text{ mA}$ Temperature coefficient of λ , $I_F = 100\text{ mA}$	TC_λ	0.3	nm/K

Gruppierung der Strahlstärke I_e in Achsrichtung
gemessen bei einem Raumwinkel $\Omega = 0.01\text{ sr}$
Grouping of Radiant Intensity I_e in Axial Direction
at a solid angle of $\Omega = 0.01\text{ sr}$

Bezeichnung Parameter	Symbol Symbol	Wert Value		Einheit Unit
		LD 271 LD 271 L	LD 271 H LD 271 LH	
Strahlstärke Radiant intensity $I_F = 100\text{ mA}$, $t_p = 20\text{ ms}$ $I_F = 1\text{ A}$, $t_p = 100\text{ }\mu\text{s}$	I_e $I_{e\text{ typ.}}$	15 (> 10) 120	> 16	mW/sr mW/sr

Relative Spectral emission

$I_{rel} = f(\lambda)$

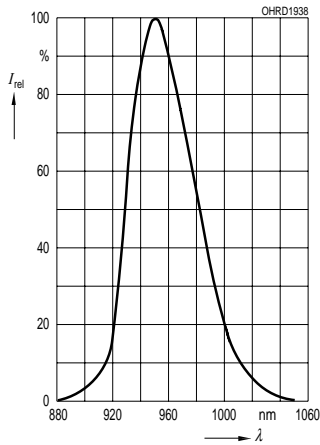

Radiant Intensity $\frac{I_e}{I_e 100 \text{ mA}} = f(I_F)$

Single pulse, $t_p = 20 \mu\text{s}$

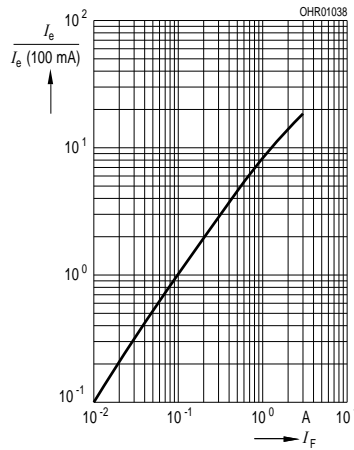

Max. Permissible Forward Current

$I_F = f(T_A)$

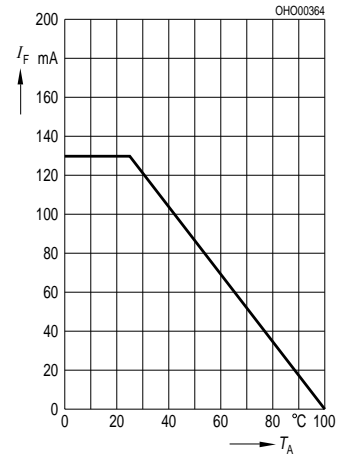

Forward Current

$I_F = f(V_F)$, single pulse, $t_p = 20 \mu\text{s}$

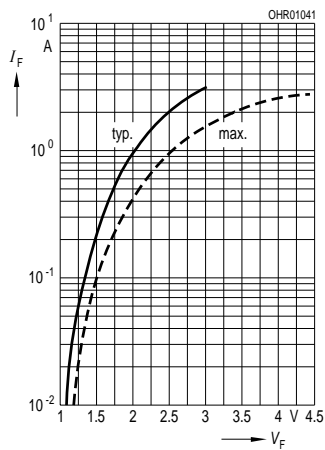

Permissible Pulse Handling Capability

$I_F = f(\tau)$, $T_C = 25 \text{ }^\circ\text{C}$, duty cycle $D = \text{parameter}$

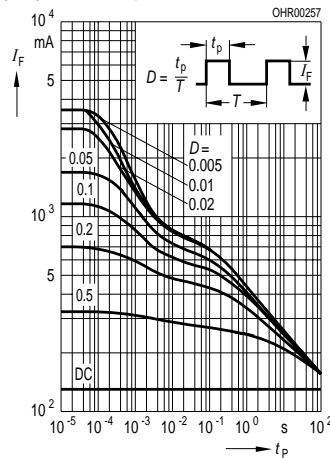

Radiation Characteristics $I_{rel} = f(\varphi)$

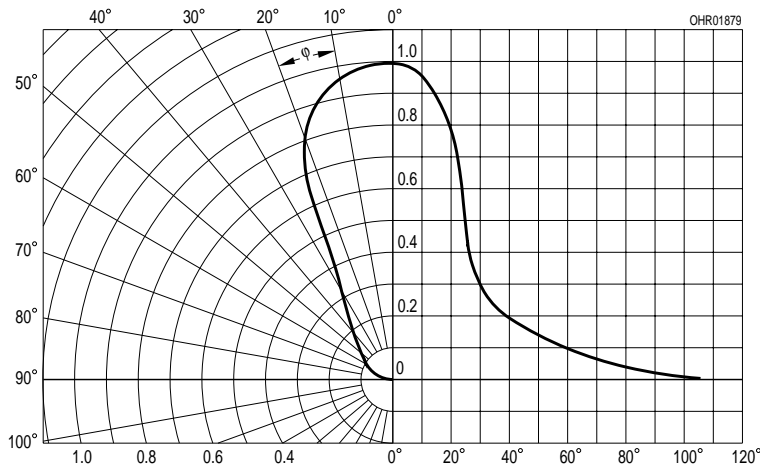

**Maßzeichnung
Package Outlines**

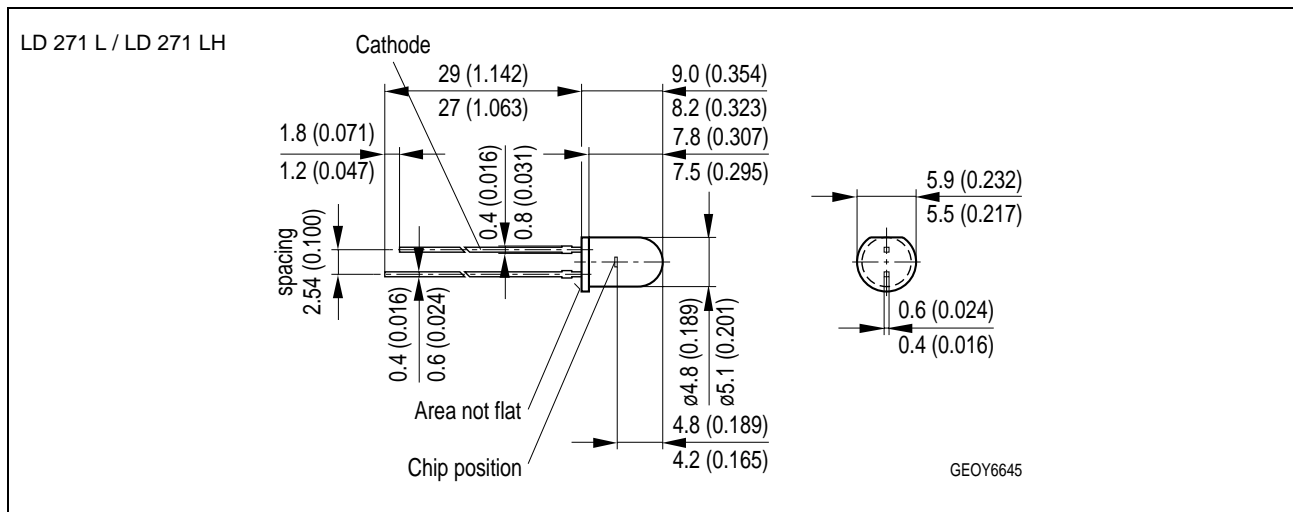
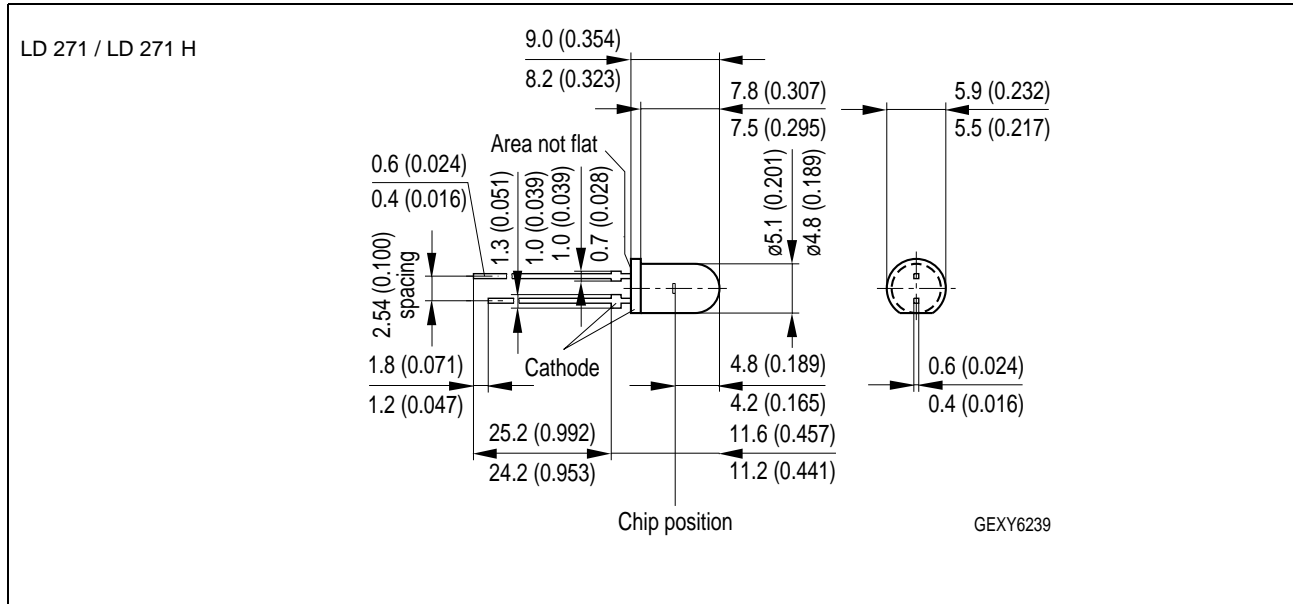

Maße in mm (inch) / Dimensions in mm (inch).

Gehäusefarbe: grau

Brechungsindex Verguss: 1.53

Package Colour: grey

Refractive index resin: 1.53

Lötbedingungen
Soldering Conditions

Wellenlöten (TTW)
TTW Soldering

(nach CECC 00802)
(acc. to CECC 00802)

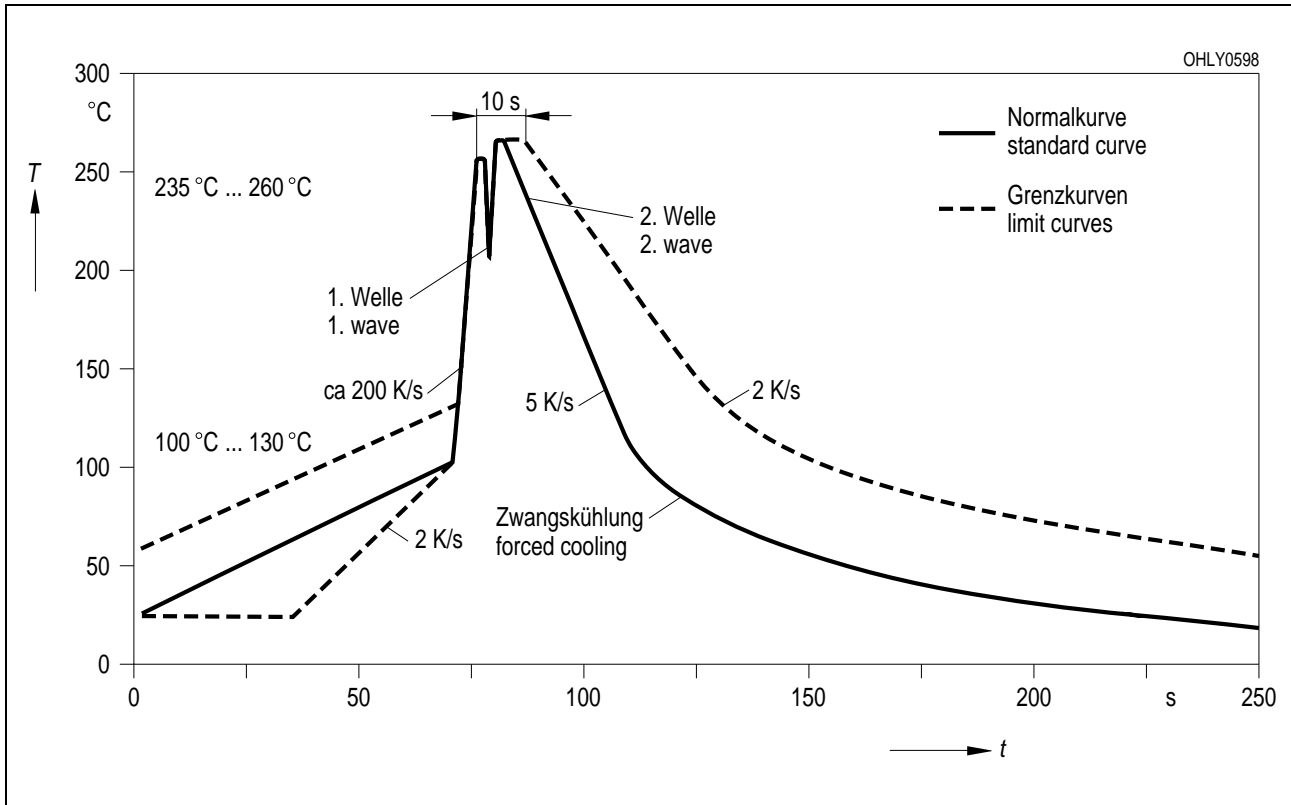

Empfohlenes Lötpad design Wellenlöten (TTW)
Recommended Solder Pad TTW Soldering

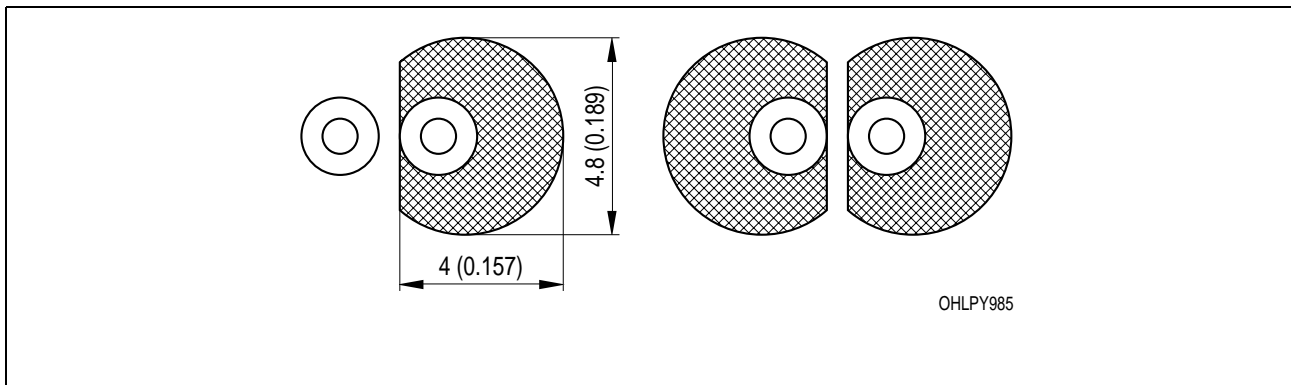

Maße in mm (inch) / Dimensions in mm (inch).

Published by
OSRAM Opto Semiconductors GmbH
Wernerwerkstrasse 2, D-93049 Regensburg
www.osram-os.com
© All Rights Reserved.

EU RoHS and China RoHS compliant product



此产品符合欧盟 RoHS 指令的要求；

按照中国的相关法规和标准，不含有毒有害物质或元素。

The information describes the type of component and shall not be considered as assured characteristics. All typical data and graphs are basing on sample base, but don't represent the production range. If required, e.g. because of technical improvements, the typ. data will be changed without any further notice.

Terms of delivery and rights to change design reserved. Due to technical requirements components may contain dangerous substances. For information on the types in question please contact our Sales Organization.

Packing

Please use the recycling operators known to you. We can also help you – get in touch with your nearest sales office. By agreement we will take packing material back, if it is sorted. You must bear the costs of transport. For packing material that is returned to us unsorted or which we are not obliged to accept, we shall have to invoice you for any costs incurred.

Components used in life-support devices or systems must be expressly authorized for such purpose! Critical components ¹, may only be used in life-support devices or systems ² with the express written approval of OSRAM OS.

¹ A critical component is a component used in a life-support device or system whose failure can reasonably be expected to cause the failure of that life-support device or system, or to affect its safety or effectiveness of that device or system.

² Life support devices or systems are intended (a) to be implanted in the human body, or (b) to support and/or maintain and sustain human life. If they fail, it is reasonable to assume that the health of the user may be endangered.