

GaAs-IR-Lumineszenzdiode
GaAs Infrared Emitter
Lead (Pb) Free Product - RoHS Compliant

SFH 400
SFH 401



SFH 400



SFH 401

Wesentliche Merkmale

- Kathode galvanisch mit dem Gehäuseboden verbunden
- Hohe Zuverlässigkeit
- Gute spektrale Anpassung an Si-Fotoempfänger
- Hermetisch dichtes Metallgehäuse
- SFH 401: Gehäusegleich mit BPX 43, BPY 62

Features

- Cathode is electrically connected to the case
- High reliability
- Matches all Si-Photodetectors
- Hermetically sealed package
- SFH 401: Same package as BPX 43, BPY 62

Anwendungen

- Lichtschranken für Gleich- und Wechsellichtbetrieb
- IR-Gerätefernsteuerungen
- Sensorik
- Lichtgitter

Applications

- Photointerrupters
- IR remote control
- Sensor technology
- Light curtains

Typ Type	Bestellnummer Ordering Code	Gehäuse Package
SFH 400	Q62702P0096	18 A3 DIN 41876 (TO-18), Glaslinse, hermetisch dichtes Gehäuse, Anschlüsse im 2.54-mm-Raster ($1/10''$)
SFH 401	Q62702P0097	18 A3 DIN 41876 (TO-18) glass lens, hermetically sealed package, solder tabs lead spacing 2.54 mm ($1/10''$)

Grenzwerte ($T_C = 25\text{ °C}$)
Maximum Ratings

Bezeichnung Parameter	Symbol Symbol	Wert Value	Einheit Unit
Betriebs- und Lagertemperatur Operating and storage temperature range SFH 400	$T_{op}; T_{stg}$	- 40 ... + 125	°C
Betriebs- und Lagertemperatur Operating and storage temperature range SFH 401	$T_{op}; T_{stg}$	- 40 ... + 100	°C
Sperrspannung Reverse voltage	V_R	5	V
Durchlassstrom Forward current	I_F	300	mA
Stoßstrom, $t_p = 10\ \mu\text{s}$, $D = 0$ Surge current	I_{FSM}	3	A
Verlustleistung Power dissipation	P_{tot}	470	mW
Wärmewiderstand Thermal resistance	R_{thJA} R_{thJC}	450 160	K/W K/W

Kennwerte ($T_A = 25\text{ °C}$)
Characteristics

Bezeichnung Parameter	Symbol Symbol	Wert Value	Einheit Unit
Wellenlänge der Strahlung Wavelength at peak emission $I_F = 100\text{ mA}$, $t_p = 20\text{ms}$	λ_{peak}	950	nm
Spektrale Bandbreite bei 50% von I_{max} Spectral bandwidth at 50% of I_{max} $I_F = 100\text{ mA}$, $t_p = 20\text{ms}$	$\Delta\lambda$	55	nm
Abstrahlwinkel Half angle SFH 400 SFH 401	φ φ	± 6 ± 15	Grad deg.
Aktive Chipfläche Active chip area	A	0.25	mm ²
Abmessungen der aktiven Chipfläche Dimension of the active chip area	$L \times B$ $L \times W$	0.5×0.5	mm ²

Kennwerte ($T_A = 25\text{ °C}$)
Characteristics (cont'd)

Bezeichnung Parameter	Symbol Symbol	Wert Value	Einheit Unit
Abstand Chipoberfläche bis Linsenscheitel Distance chip front to lens top SFH 400 SFH 401	H H	4.0 ... 4.8 2.8 ... 3.7	mm mm
Schaltzeiten, I_e von 10% auf 90% und von 90% auf 10%, bei $I_F = 100\text{ mA}$, $R_L = 50\ \Omega$ Switching times, I_e from 10% to 90% and from 90% to 10%, $I_F = 100\text{ mA}$, $R_L = 50\ \Omega$	t_r, t_f	1	μs
Kapazität Capacitance $V_R = 0\text{ V}$, $f = 1\text{ MHz}$	C_o	40	pF
Durchlassspannung Forward voltage $I_F = 100\text{ mA}$, $t_p = 20\text{ ms}$ $I_F = 1\text{ A}$, $t_p = 100\ \mu\text{s}$	V_F V_F	1.30 (≤ 1.5) 1.90 (≤ 2.5)	V V
Sperrstrom Reverse current $V_R = 5\text{ V}$	I_R	0.01 (≤ 1)	μA
Gesamtstrahlungsfluss Total radiant flux $I_F = 100\text{ mA}$, $t_p = 20\text{ ms}$	Φ_e	8	mW
Temperaturkoeffizient von I_e bzw. Φ_e , $I_F = 100\text{ mA}$ Temperature coefficient of I_e or Φ_e , $I_F = 100\text{ mA}$	TC_I	- 0.55	%/K
Temperaturkoeffizient von V_F , $I_F = 100\text{ mA}$ Temperature coefficient of V_F , $I_F = 100\text{ mA}$	TC_V	- 1.5	mV/K
Temperaturkoeffizient von λ , $I_F = 100\text{ mA}$ Temperature coefficient of λ , $I_F = 100\text{ mA}$	TC_λ	+ 0.3	nm/K

Gruppierung der Strahlstärke I_e in Achsrichtunggemessen bei einem Raumwinkel $\Omega = 0.01$ sr**Grouping of Radiant Intensity I_e in Axial Direction**at a solid angle of $\Omega = 0.01$ sr

Bezeichnung Parameter	Symbol Symbol	Wert Value				Einheit Unit
		SFH 400-2	SFH 400-3	SFH 401-2	SFH 401-3	
Strahlstärke Radiant intensity $I_F = 100$ mA, $t_p = 20$ ms	$I_{e \text{ min}}$	20	> 32	10	>16	mW/sr
	$I_{e \text{ max}}$	40	–	20	–	mW/sr
Strahlstärke Radiant intensity $I_F = 1$ A, $t_p = 100$ μ s	$I_{e \text{ typ.}}$	300	320	120	190	mW/sr

Radiation Characteristics, SFH 400, $I_{rel} = f(\varphi)$

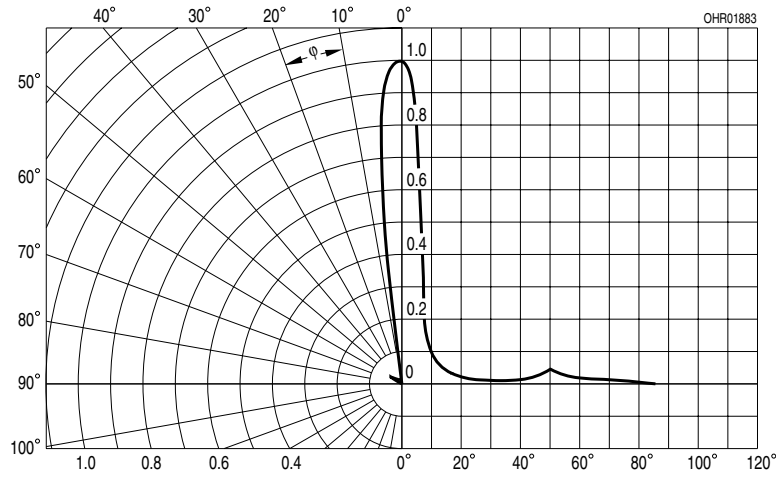

Radiation Characteristics, SFH 401, $I_{rel} = f(\varphi)$

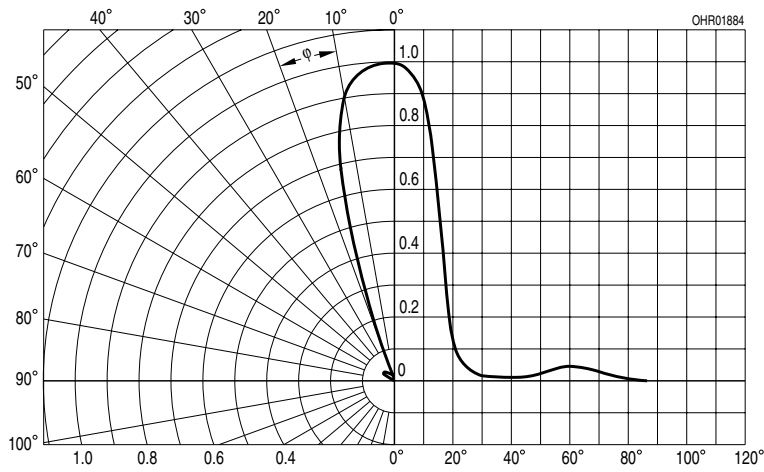

Relative Spectral Emission

$I_{rel} = f(\lambda)$

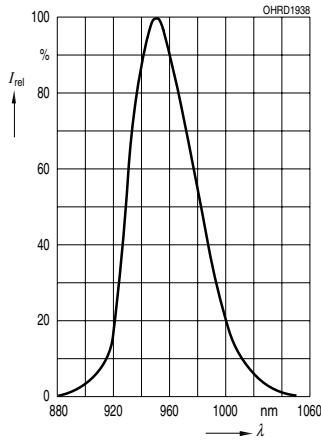

Radiant Intensity $\frac{I_e}{I_e 100 \text{ mA}} = f(I_F)$

Single pulse, $t_p = 20 \mu\text{s}$

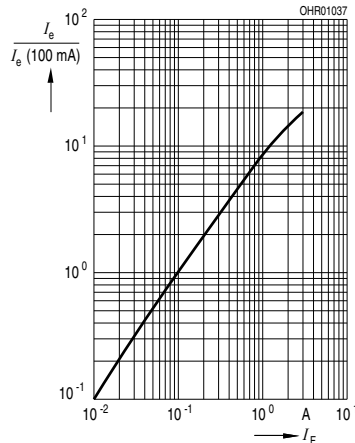

Max. Permissible Forward Current SFH 401, $I_F = f(T_A)$

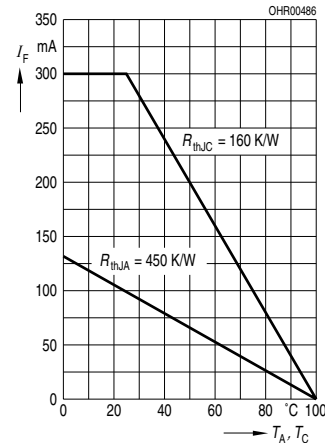

Forward Current

$I_F = f(V_F)$

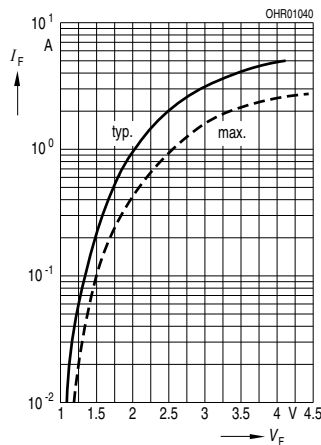

Permissible Pulse Handling Capability $I_F = f(\tau)$, $T_C = 25^\circ\text{C}$, $R_{thJC} = 160 \text{ K/W}$, duty cycle $D =$ parameter

$D = \frac{t_p}{T}$

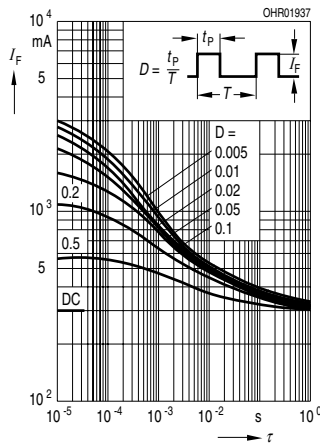

Max. Permissible Forward Current SFH 400, $I_F = f(T_A)$

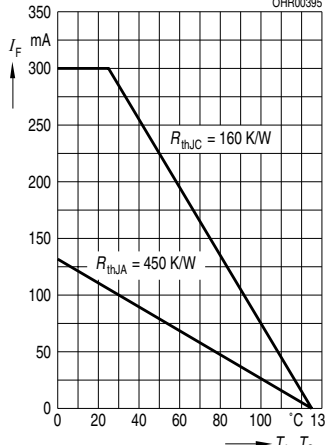

**Maßzeichnung
Package Outlines**

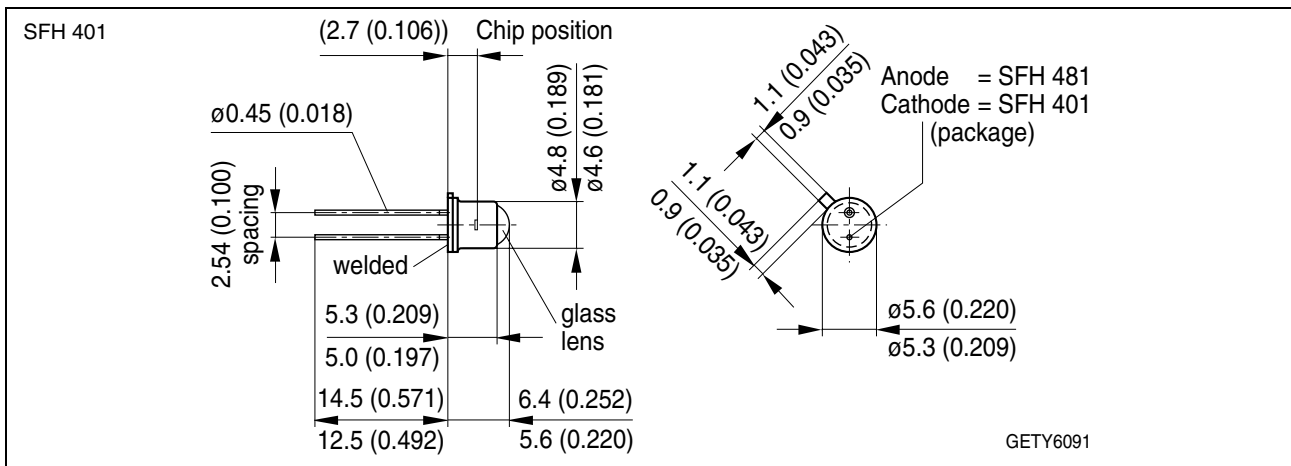
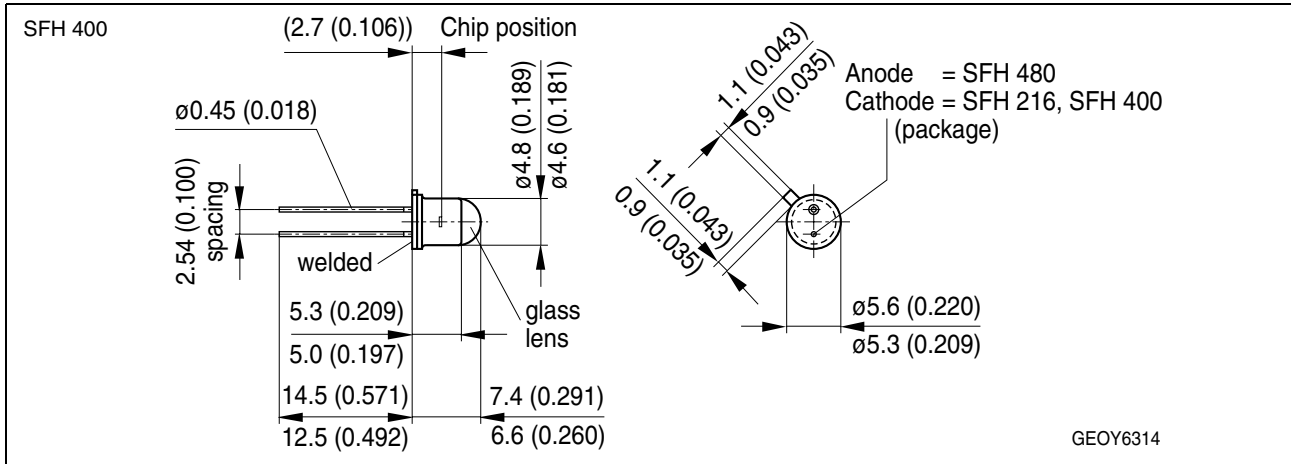

Maße in mm (inch) / Dimensions in mm (inch).

Lötbedingungen
Soldering Conditions
Wellenlöten (TTW)
TTW Soldering

(nach CECC 00802)
(acc. to CECC 00802)

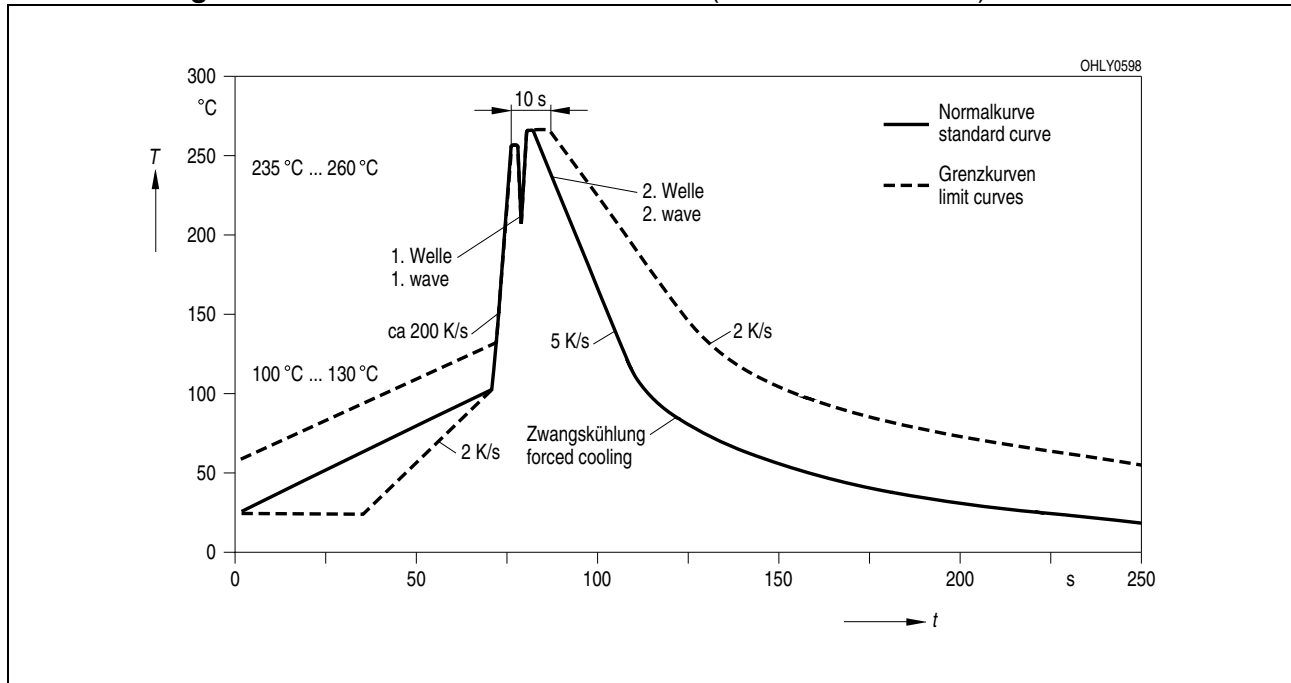

Published by
OSRAM Opto Semiconductors GmbH
Wernerwerkstrasse 2, D-93049 Regensburg
www.osram-os.com
© All Rights Reserved.

EU RoHS and China RoHS compliant product



此产品符合欧盟 RoHS 指令的要求；

按照中国的相关法规和标准，不含有毒有害物质或元素。

The information describes the type of component and shall not be considered as assured characteristics. Terms of delivery and rights to change design reserved. Due to technical requirements components may contain dangerous substances. For information on the types in question please contact our Sales Organization.

Packing

Please use the recycling operators known to you. We can also help you – get in touch with your nearest sales office. By agreement we will take packing material back, if it is sorted. You must bear the costs of transport. For packing material that is returned to us unsorted or which we are not obliged to accept, we shall have to invoice you for any costs incurred.

Components used in life-support devices or systems must be expressly authorized for such purpose! Critical components¹, may only be used in life-support devices or systems² with the express written approval of OSRAM OS.

¹ A critical component is a component used in a life-support device or system whose failure can reasonably be expected to cause the failure of that life-support device or system, or to affect its safety or effectiveness of that device or system.

² Life support devices or systems are intended (a) to be implanted in the human body, or (b) to support and/or maintain and sustain human life. If they fail, it is reasonable to assume that the health of the user may be endangered.