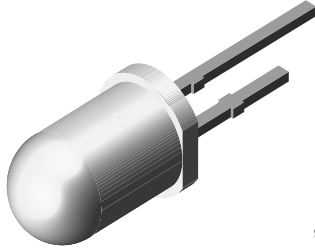


High Speed Infrared Emitting Diode, 890 nm, GaAlAs Double Hetero



94 8390

DESCRIPTION

TSHF5410 is an infrared, 890 nm emitting diode in GaAlAs double hetero (DH) technology with high radiant power and high speed, molded in a clear, untinted plastic package.

FEATURES

- Package type: leaded
- Package form: T-1 $\frac{3}{4}$
- Dimensions (in mm): \varnothing 5
- Leads with stand-off
- Peak wavelength: $\lambda_p = 890$ nm
- High reliability
- High radiant power
- High radiant intensity
- Angle of half intensity: $\varphi = \pm 22^\circ$
- Low forward voltage
- Suitable for high pulse current operation
- High modulation bandwidth: $f_c = 12$ MHz
- Good spectral matching with Si photodetectors
- Compliant to RoHS directive 2002/95/EC and in accordance to WEEE 2002/96/EC
- Halogen-free according to IEC 61249-2-21 definition



RoHS
COMPLIANT
HALOGEN
FREE

APPLICATIONS

- Infrared high speed remote control and free air data transmission systems with high modulation frequencies or high data transmission rate requirements
- Transmission systems according to IrDA requirements and for carrier frequency based systems (e.g. ASK/FSK - coded, 450 kHz or 1.3 MHz)

PRODUCT SUMMARY

| COMPONENT | I_e (mW/sr) | φ (deg) | λ_p (nm) | t_r (ns) |
|-----------|---------------|-----------------|------------------|------------|
| TSHF5410 | 70 | ± 22 | 890 | 30 |

Note

Test conditions see table "Basic Characteristics"

ORDERING INFORMATION

| ORDERING CODE | PACKAGING | REMARKS | PACKAGE FORM |
|---------------|-----------|------------------------------|-------------------|
| TSHF5410 | Bulk | MOQ: 4000 pcs, 4000 pcs/bulk | T-1 $\frac{3}{4}$ |

Note

MOQ: minimum order quantity

ABSOLUTE MAXIMUM RATINGS

| PARAMETER | TEST CONDITION | SYMBOL | VALUE | UNIT |
|-------------------------------------|--|------------|---------------|------------|
| Reverse voltage | | V_R | 5 | V |
| Forward current | | I_F | 100 | mA |
| Peak forward current | $t_p/T = 0.5, t_p = 100 \mu s$ | I_{FM} | 200 | mA |
| Surge forward current | $t_p = 100 \mu s$ | I_{FSM} | 1.5 | A |
| Power dissipation | | P_V | 160 | mW |
| Junction temperature | | T_j | 100 | $^\circ C$ |
| Operating temperature range | | T_{amb} | - 40 to + 85 | $^\circ C$ |
| Storage temperature range | | T_{stg} | - 40 to + 100 | $^\circ C$ |
| Soldering temperature | $t \leq 5$ s, 2 mm from case | T_{sd} | 260 | $^\circ C$ |
| Thermal resistance junction/ambient | J-STD-051, leads 7 mm, soldered on PCB | R_{thJA} | 230 | K/W |

Note

$T_{amb} = 25 \text{ }^\circ C$, unless otherwise specified

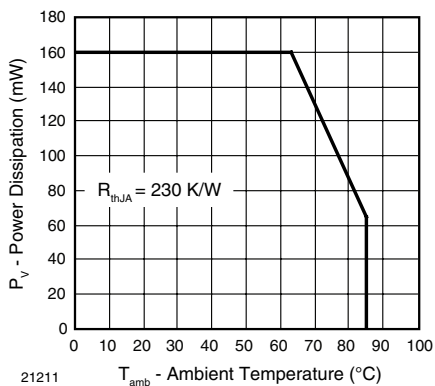


Fig. 1 - Power Dissipation Limit vs. Ambient Temperature

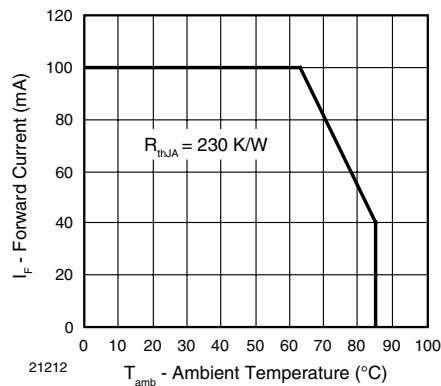


Fig. 2 - Forward Current Limit vs. Ambient Temperature

| BASIC CHARACTERISTICS | | | | | | |
|---|---|-----------------------------|------|--------|------|-------|
| PARAMETER | TEST CONDITION | SYMBOL | MIN. | TYP. | MAX. | UNIT |
| Forward voltage | I _F = 100 mA, t _p = 20 ms | V _F | | 1.4 | 1.6 | V |
| | I _F = 1 A, t _p = 100 μs | V _F | | 2.3 | | V |
| Temperature coefficient of V _F | I _F = 1 mA | TK _{V_F} | | - 1.8 | | mV/K |
| Reverse current | V _R = 5 V | I _R | | | 10 | μA |
| Junction capacitance | V _R = 0 V, f = 1 MHz, E = 0 | C _j | | 125 | | pF |
| Radiant intensity | I _F = 100 mA, t _p = 20 ms | I _e | 45 | 70 | 135 | mW/sr |
| | I _F = 1 A, t _p = 100 μs | I _e | | 700 | | mW/sr |
| Radiant power | I _F = 100 mA, t _p = 20 ms | φ _e | | 50 | | mW |
| Temperature coefficient of φ _e | I _F = 100 mA | TKφ _e | | - 0.35 | | %/K |
| Angle of half intensity | | φ | | ± 22 | | deg |
| Peak wavelength | I _F = 100 mA | λ _p | | 890 | | nm |
| Spectral bandwidth | I _F = 100 mA | Δλ | | 40 | | nm |
| Temperature coefficient of λ _p | I _F = 100 mA | TKλ _p | | 0.25 | | nm/K |
| Rise time | I _F = 100 mA | t _r | | 30 | | ns |
| Fall time | I _F = 100 mA | t _f | | 30 | | ns |
| Cut-off frequency | I _{DC} = 70 mA, I _{AC} = 30 mA pp | f _c | | 12 | | MHz |
| Virtual source diameter | | d | | 2.1 | | mm |

Note

T_{amb} = 25 °C, unless otherwise specified

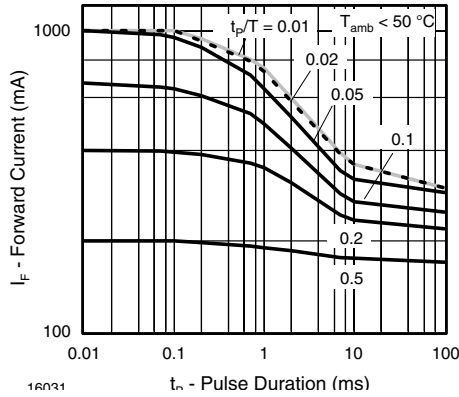
BASIC CHARACTERISTICS
 $T_{amb} = 25\text{ }^{\circ}\text{C}$, unless otherwise specified


Fig. 3 - Pulse Forward Current vs. Pulse Duration

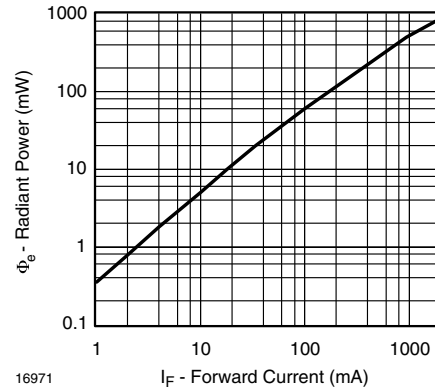


Fig. 6 - Radiant Power vs. Forward Current

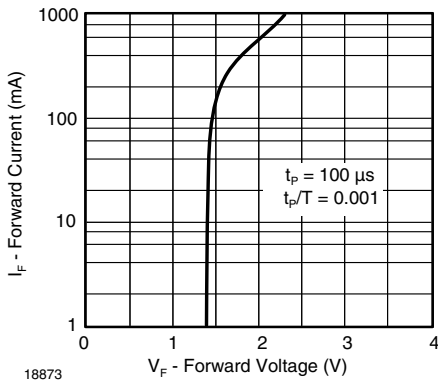


Fig. 4 - Forward Current vs. Forward Voltage

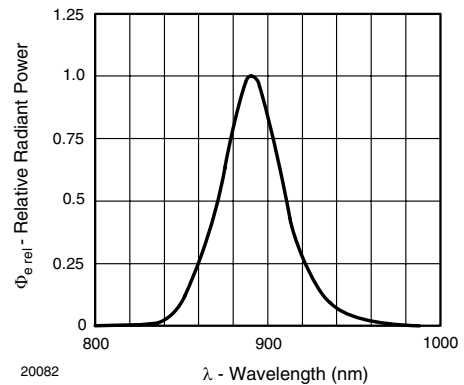


Fig. 7 - Relative Radiant Power vs. Wavelength

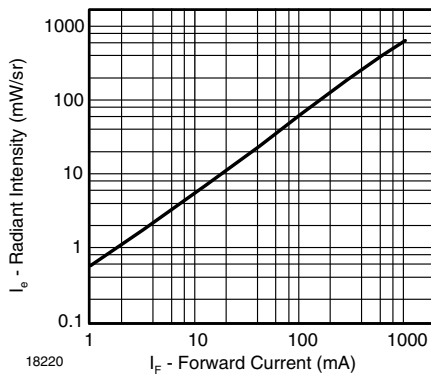


Fig. 5 - Radiant Intensity vs. Forward Current

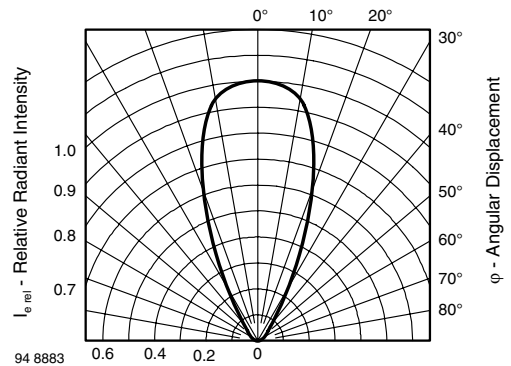


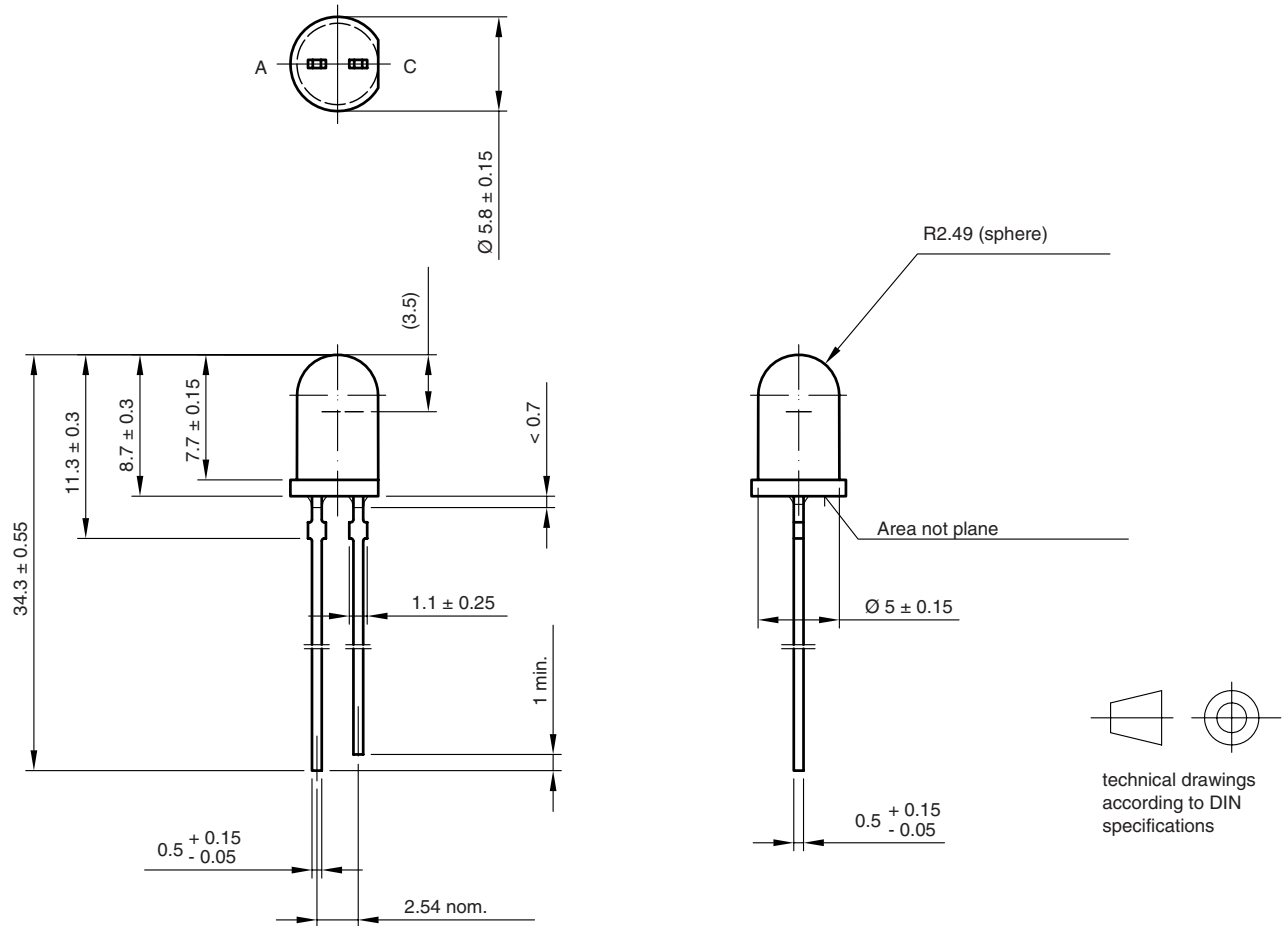
Fig. 8 - Relative Radiant Intensity vs. Angular Displacement

TSHF5410

Vishay Semiconductors High Speed Infrared Emitting Diode,
890 nm, GaAlAs Double Hetero



PACKAGE DIMENSIONS in millimeters



6.544-5258.06-4
Issue: 3; 19.05.09
95 11260



Disclaimer

ALL PRODUCT, PRODUCT SPECIFICATIONS AND DATA ARE SUBJECT TO CHANGE WITHOUT NOTICE TO IMPROVE RELIABILITY, FUNCTION OR DESIGN OR OTHERWISE.

Vishay Intertechnology, Inc., its affiliates, agents, and employees, and all persons acting on its or their behalf (collectively, "Vishay"), disclaim any and all liability for any errors, inaccuracies or incompleteness contained in any datasheet or in any other disclosure relating to any product.

Vishay makes no warranty, representation or guarantee regarding the suitability of the products for any particular purpose or the continuing production of any product. To the maximum extent permitted by applicable law, Vishay disclaims (i) any and all liability arising out of the application or use of any product, (ii) any and all liability, including without limitation special, consequential or incidental damages, and (iii) any and all implied warranties, including warranties of fitness for particular purpose, non-infringement and merchantability.

Statements regarding the suitability of products for certain types of applications are based on Vishay's knowledge of typical requirements that are often placed on Vishay products in generic applications. Such statements are not binding statements about the suitability of products for a particular application. It is the customer's responsibility to validate that a particular product with the properties described in the product specification is suitable for use in a particular application. Parameters provided in datasheets and/or specifications may vary in different applications and performance may vary over time. All operating parameters, including typical parameters, must be validated for each customer application by the customer's technical experts. Product specifications do not expand or otherwise modify Vishay's terms and conditions of purchase, including but not limited to the warranty expressed therein.

Except as expressly indicated in writing, Vishay products are not designed for use in medical, life-saving, or life-sustaining applications or for any other application in which the failure of the Vishay product could result in personal injury or death. Customers using or selling Vishay products not expressly indicated for use in such applications do so at their own risk and agree to fully indemnify and hold Vishay and its distributors harmless from and against any and all claims, liabilities, expenses and damages arising or resulting in connection with such use or sale, including attorneys fees, even if such claim alleges that Vishay or its distributor was negligent regarding the design or manufacture of the part. Please contact authorized Vishay personnel to obtain written terms and conditions regarding products designed for such applications.

No license, express or implied, by estoppel or otherwise, to any intellectual property rights is granted by this document or by any conduct of Vishay. Product names and markings noted herein may be trademarks of their respective owners.