

### FEATURES

- **HIGH ISOLATION VOLTAGE**  
BV: 5 k Vr.m.s. MIN
- **HIGH PROPAGATION DELAY TIME**  
tPHL, tPLH: 50 ns TYP
- **LOW INPUT CURRENT**  
IFHL: 2.5 mA TYP
- **CAN BE SOLDERED BY INFRARED REFLOW SOLDERING**
- **TAPING PRODUCT NUMBER PS9601L-E3, E4**

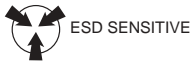

### DESCRIPTION

PS9601 and PS9601L are optically coupled isolators containing a GaAlAs LED on the light emitting side (input side), and a photodiode and a signal processing circuit on the light receiving side (output side), on one chip. PS9601 is in a plastic DIP (Dual In-Line Package) and PS9601L is in a lead bending type (Gull-wing) for surface mount.

### APPLICATIONS

- **COMPUTER AND PERIPHERAL MEMORY**
- **ELECTRONIC INSTRUMENT**
- **AUDIO-VISUAL**

### ELECTRICAL CHARACTERISTICS (TA = -40 to +85 °C)

PART NUMBER			PS9601, PS9601L			
	SYMBOLS	PARAMETERS	UNITS	MIN	TYP	MAX
Diode	VF	Forward Voltage, IF = 10 mA, TA = 25 °C	V	1.4	1.65	1.9
	IR	Reverse Current, VR = 5 V, TA = 25 °C	µA			10
	Ct	Capacitance, V = 0, f = 1 MHz, TA = 25 °C	pF		60	
Detector	IOH	High Level Output Current VCC = VO = 5.5 V, IF = 250 µs, VE = 2 V	µA		2	250
	VOL	Low Level Output Voltage VCC = 5.5 V, IF = 5 mA, VE = 2 V, IO = 13 mA	V		0.2	0.6
	ICCH	High Level Supply Current, VCC = 5.5 V, VE = 0.5 V, IF = 0	mA	5	7	10
	ICCL	Low Level Supply Current, VCC = 5.5 V, VE = 2 V, IF = 10 mA	mA	10	13	18
	IEH	High Level Enable Current, VCC = 5.5 V, VEH = 2 V	mA	-0.7	-1	-1.5
	IEL	Low Level Enable Current, VCC = 5.5 V, VEL = 0.5 V	mA	-1	-1.4	-2
Coupled	IFHL	Threshold Input Current, High → Low VCC = 5 V, VE = 2 V, TA = -40 to +85 °C, VO = 0.8 V, RL = 350 Ω	mA	0.5	2.5	5
	R1-2	Isolation Resistance, Vin-out = 1 k VDC, RH 40 to 60 %	Ω	10 <sup>11</sup>		
	C1-2	Isolation Capacitance, V = 0, f = 1 MHz	pF		0.6	
	tPHL	Propagation Delay Time <sup>1</sup> , High → Low, VCC = 5 V, IF = 7.5 mA, RL = 350 Ω, CL = 15 pF	ns		50	75
	tPLH	Propagation Delay Time <sup>1</sup> , Low → High, VCC = 5 V, IF = 7.5 mA, RL = 350 Ω, CL = 15 pF	ns		50	75
	tr	Rise Time, VCC = 5 V, IF = 7.5 mA, RL = 350 Ω, CL = 15 pF	ns		20	
	tf	Fall Time, VCC = 5 V, IF = 7.5 mA, RL = 350 Ω, CL = 15 pF	ns		10	
	TEHL	Enable Propagation <sup>2</sup> , Delay Time, High → Low VCC = 5 V, IF = 7.5 mA, VEH = 3 V, VEL = 0.5 V, RL = 350 Ω, CL = 15 pF	ns		10	
	TELH	Enable Propagation <sup>2</sup> , Delay Time, Low → High VCC = 5 V, IF = 7.5 mA, VEH = 3 V, VEL = 0.5 V, RL = 350 Ω, CL = 15 pF	ns		25	

Notes: See Next Page

1. Test Circuit for Propagation delay time

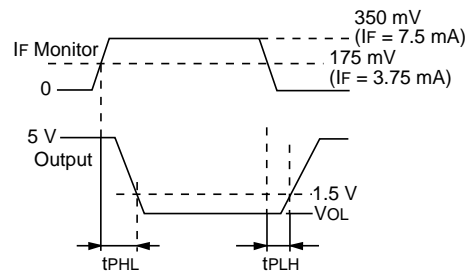
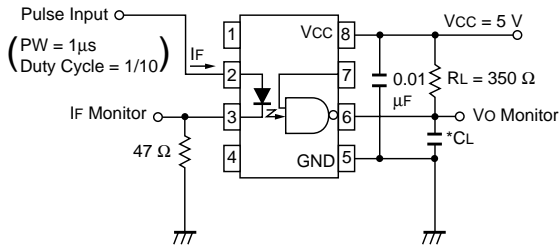

\*CL is approximately 15 pF, which includes probe and stray wiring capacitance

2. Test Circuit for enable Propagation delay time

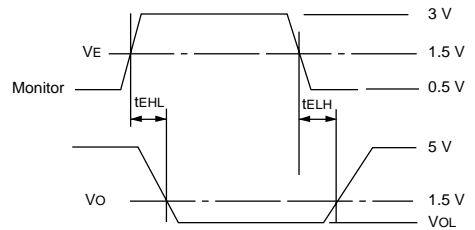
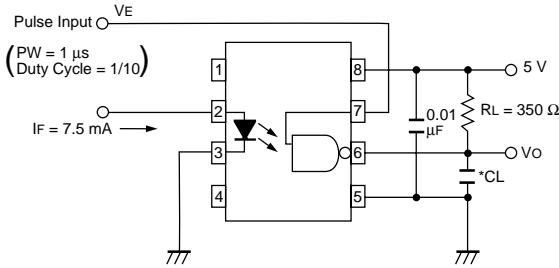

ABSOLUTE MAXIMUM RATINGS<sup>1</sup> (TA = 25°C)

SYMBOLS	PARAMETERS	UNITS	RATINGS
Diode			
IF	Forward Current	mA	30
VR	Reverse Voltage	V	5
Pd	Power Dissipation	mW	60
Detector			
Vcc	Supply Voltage	V	7
Vo	Output Voltage	V	7
Io	Output Current	mA	50
VE	Enable Voltage	V	5.5
Pc	Power Dissipation	mW	85
BV	Isolation Voltage <sup>2</sup>	V <sub>r.m.s.</sub>	5000
TOP	Operating Temperature	°C	-40 to +85
TSTG	Storage Temperature	°C	-55 to +125

Notes:

- Operation in excess of any one of these parameters may result in permanent damage.
- AC voltage for 1 minute at TA = 25 °C, RH = 60 % between input and output.

TRUTH TABLE

LED	ENABLE	OUT
ON	H	L
OFF	H	H
ON	L	H
OFF	L	H
ON	N/C	L
OFF	N/C	H

RECOMMENDED OPERATING CONDITIONS (TA = 25°C)

PART NUMBER			PS9601,PS9601L		
SYMBOLS	PARAMETERS	UNITS	MIN	TYP	MAX
IFL	Low Level Input Current	μA	0		250
IFH	High Level Input Current	mA	7	10	15
VEH	High Level Enable Voltage	V	2		Vcc
VEL	High Level Enable Voltage	V	0		0.8
VCC	Supply Voltage	V	4.5	5	5.5
TOP	Operating Temperature	°C	0	25	70

TYPICAL PERFORMANCE CURVES (TA = 25 °C)

MAX. FORWARD CURRENT vs. AMBIENT TEMPERATURE

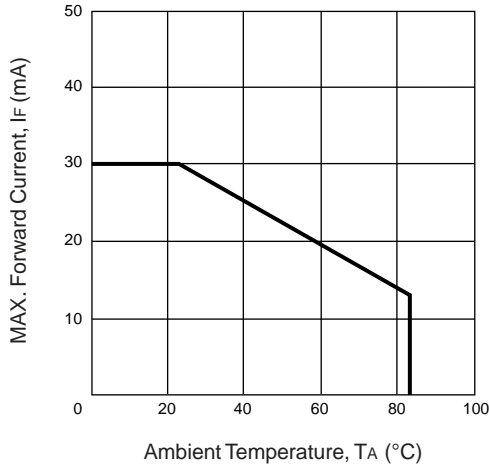

POWER DISSIPATION vs. AMBIENT TEMPERATURE

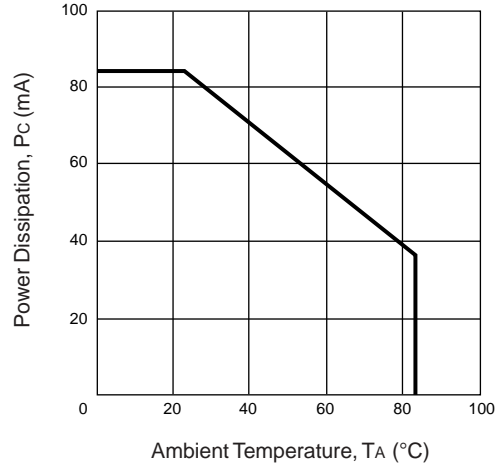

FORWARD CURRENT vs. FORWARD VOLTAGE

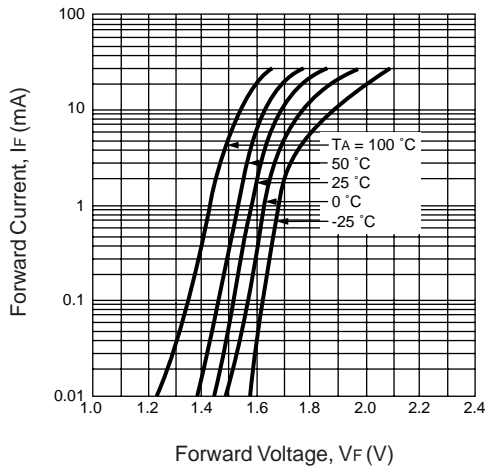

THRESHOLD CURRENT vs. AMBIENT TEMPERATURE

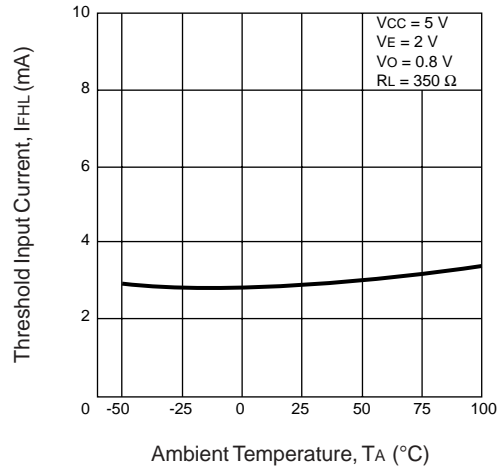

OUTPUT VOLTAGE vs. FORWARD VOLTAGE

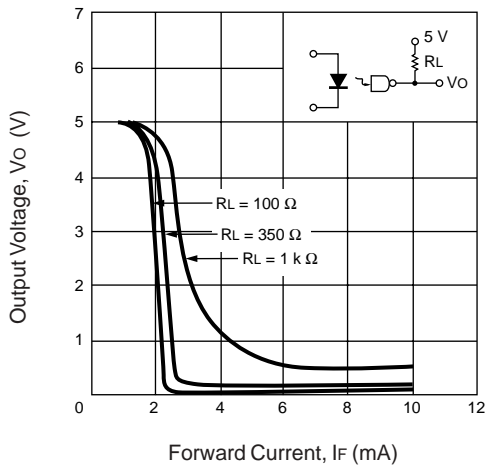

LOW LEVEL OUTPUT VOLTAGE vs. AMBIENT TEMPERATURE

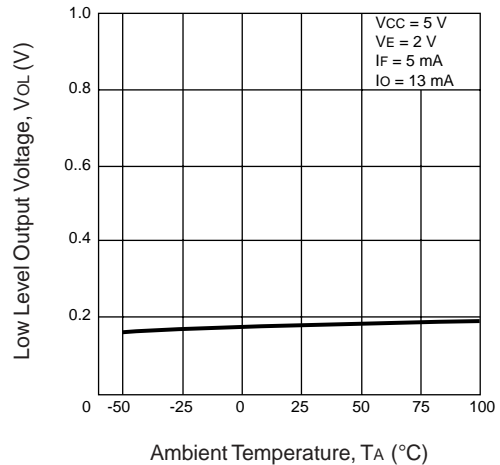

TYPICAL PERFORMANCE CURVES (TA = 25 °C)

PROPAGATION DELAY TIME vs. FORWARD CURRENT

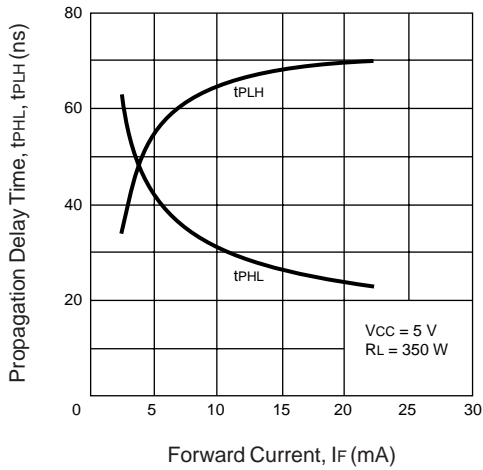

PROPAGATION DELAY TIME vs. LOAD RESISTANCE

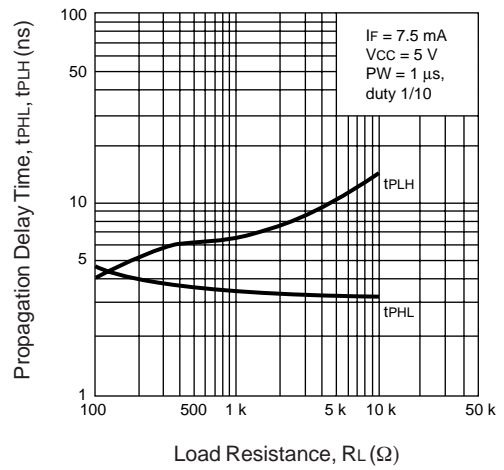

PROPAGATION DELAY TIME vs. AMBIENT TEMPERATURE

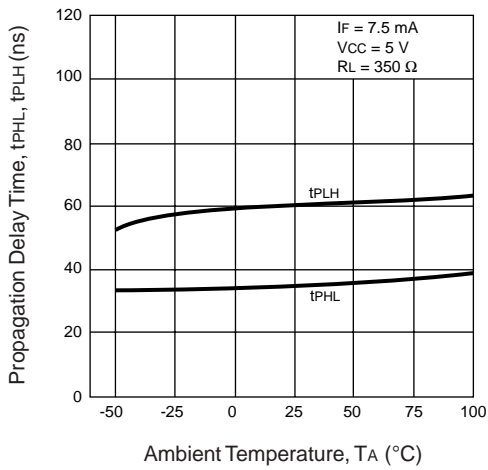

SWITCHING TIME vs. AMBIENT TEMPERATURE

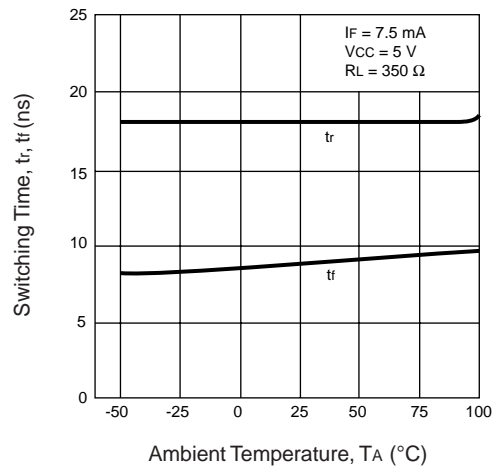

ENABLE PROPAGATION DELAY TIME vs. AMBIENT TEMPERATURE

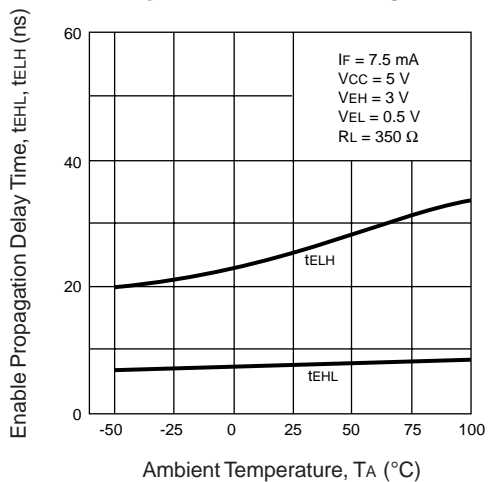

**OUTLINE DIMENSIONS** (Units in mm)

PS9601

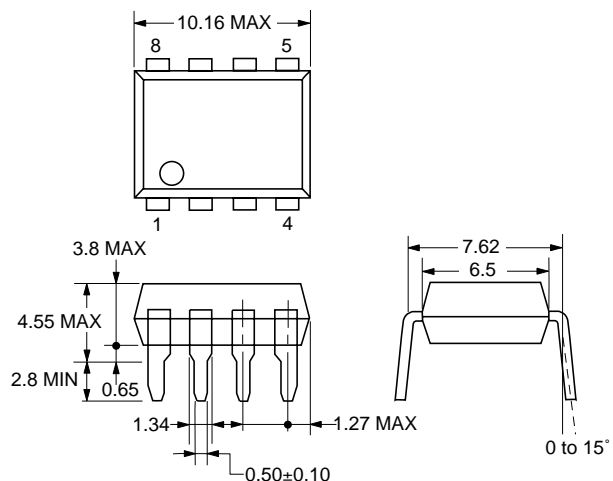

PS9601L

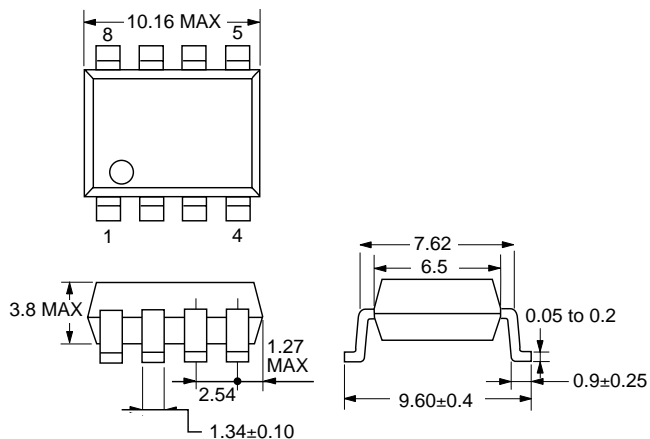

**PIN CONNECTION** (Top View)

PS9601

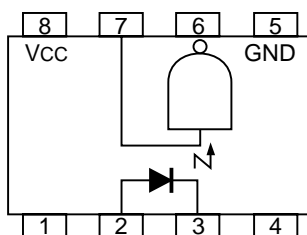

	PIN	Function
INPUT	1.	NC
	2.	Anode
	3.	Cathode
	4.	NC
OUTPUT	5.	GND
	6.	Vo
	7.	VE*
	8.	VCC

\*VE is pulled - up to enable operation

## RECOMMENDED SOLDERING CONDITIONS

### (1) Precautions in mounting the devices by infrared reflow soldering

- **Peak reflow temperature**  
235 °C or below (plastic surface temperature)
- **Reflow time**  
30 seconds or less (Time period during which the plastic surface temperature is 210 °C)
- **Number of reflows Processes**  
One
- **Flux**  
Rosin flux containing small amount of chlorine (The flux with a max. chlorine content of 0.2 Wt % is recommended.)

INFRARED RAY REFLOW TEMPERATURE PROFILE

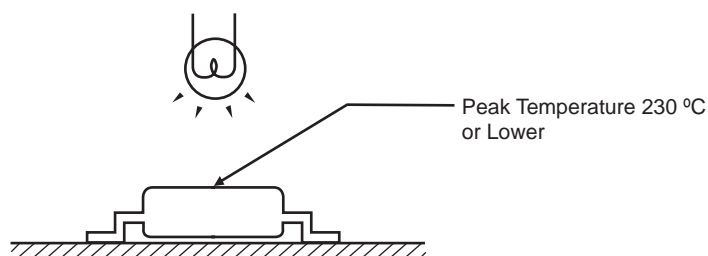
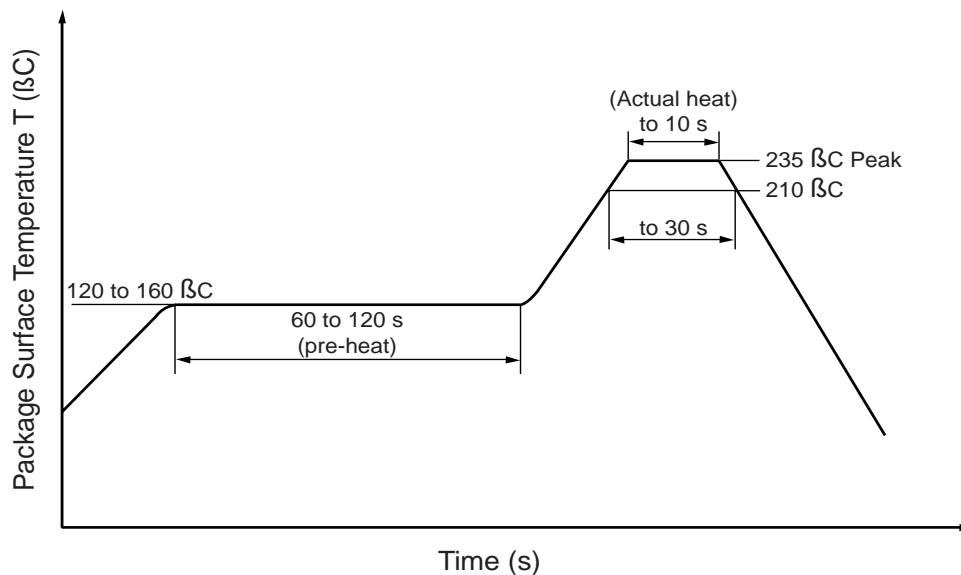

### (2) Precautions in mounting the devices in solder dip method

- **Temperature**  
260 °C or below
- **Time**  
10 seconds or less
- **Flux**  
Rosin group flux, where the amount of chloride component is small.