

Product Specification

2.125 Gb/s RoHS Compliant Short Wavelength 2x5 SFF Transceiver

FTLF8519F2xTL

PRODUCT FEATURES

- Up to 2.125 Gb/s bi-directional data links
- Standard 2x5 pin SFF footprint (MSA compliant)
- 850nm Oxide VCSEL laser transmitter
- Duplex LC connector
- RoHS compliant and Lead Free
- Up to 500m on 50/125µm MMF, 300m on 62.5/125µm MMF
- Metal enclosure, for lower EMI
- Single 3.3V power supply
- Low power dissipation <750mW
- Industrial operating temperature range: -40°C to 85°C



APPLICATIONS

- 1.25 Gb/s 1000Base-SX Ethernet
- Dual Rate 1.063/2.125 Gb/s Fibre Channel

Finisar's FTLF8519F2xTL Small Form Factor (SFF) transceivers comply with the 2x5 standard package defined by the Small Form Factor Multi-Sourcing Agreement (MSA)¹. They are simultaneously compatible with Gigabit Ethernet as specified in IEEE Std 802.3² and Fibre Channel FC- PI-2 Rev. 7.0³. They are RoHS compliant and lead-free per Directive 2002/95/EC⁴ and Finisar Application Note AN-2038.

PRODUCT SELECTION

FTLF8519F2xTL

x	G	2 Grounding Pins, Short EMI shield
	M	6 Grounding Pins, Short EMI shield
	K	2 Grounding Pins, Long EMI shield
	H	6 Grounding Pins, Long EMI shield

I. Pin Descriptions

Pin	Symbol	Name/Description	Logic Family
MS	MS	Mounting Studs are for mechanical attachment and are connected to chassis ground. Chassis ground is internally isolated from circuit grounds. Connection to user's ground plane is recommended.	NA
1	V _{EER}	Receiver Ground (Common with Transmitter Ground)	NA
2	V _{CCR}	Receiver Power Supply	NA
3	SD	Signal Detect. Logic 1 indicates normal operation.	LVTTL
4	RD-	Receiver Inverted DATA out. AC Coupled	See Rx spec.
5	RD+	Receiver Non-inverted DATA out. AC Coupled	See Rx spec.
6	V _{CCT}	Transmitter Power Supply	NA
7	V _{EET}	Transmitter Ground (Common with Receiver Ground)	NA
8	T _{DIS}	Transmitter Disable	LVTTL
9	TD+	Transmitter Non-Inverted DATA in. AC Coupled.	See Tx spec.
10	TD-	Transmitter Inverted DATA in. AC Coupled	See Tx spec.

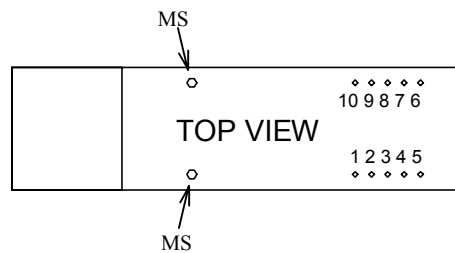
**II. Absolute Maximum Ratings**

Parameter	Symbol	Min	Typ	Max	Unit	Ref.
Maximum Supply Voltage	V _{CC}	-0.5		4.0	V	
Storage Temperature	T _S	-40		85	°C	
Case Operating Temperature	T _{OP}	-40		85	°C	
Relative Humidity	RH	0		85	%	1
Hand Lead Soldering Temperature/Time				260/10	°C/s	
Wave Lead Soldering Temperature/Time				260/10	°C/s	

Notes:

1. Non condensing.

III. Electrical Characteristics ($T_{OP} = -40$ to 85 °C, $V_{CC} = 3.0$ to 3.6 Volts)

Parameter	Symbol	Min	Typ	Max	Unit	Ref.
Supply Voltage	V_{CC}	3.0		3.6	V	
Supply Current	I_{CC}		180	240	mA	
Transmitter						
Input differential impedance	R_{in}		100		Ω	1
Single ended data input swing	$V_{in,pp}$	250		1200	mV	
Transmit Disable Voltage	V_D	2		V_{CC}	V	
Transmit Enable Voltage	V_{EN}	V_{EE}		$V_{EE} + 0.8$	V	2
Receiver						
Output differential impedance	R_{out}		100		Ω	1
Single ended data output swing	$V_{out,pp}$	250	350	550	mV	3
Data output rise/fall time	t_r / t_f			170	ps	4
Mask Margin			45%			
Signal Detect Normal	SD_{normal}			$V_{CC_{HOST}}$	V	5
Signal Detect Fault	SD_{fault}	V_{EE}		$V_{EE} + 0.5$	V	5
Power Supply Rejection	PSR			100	mVpp	6
Deterministic Jitter Contribution (p-p)	$RX \Delta DJ$			51.7	ps	7
Total Jitter Contribution (p-p)	$RX \Delta TJ$			123	ps	8

Notes:

1. AC coupled.
2. Or open circuit.
3. Into 100Ω differential termination. Data pattern is PRBS 2^7-1 .
4. 20 – 80 %.
5. Signal detect is LVTTTL. Logic 1 indicates normal operation; logic 0 indicates no signal detected.
6. All transceiver specifications are compliant with a power supply sinusoidal modulation of 20 Hz to 1.5 MHz up to specified value applied through the power supply filtering network shown on page 23 of the Small Form-factor Pluggable (SFP) Transceiver MultiSource Agreement (MSA), September 14, 2000⁵.
7. Measured with DJ-free data input signal. In actual application, output DJ will be the sum of input DJ and ΔDJ .
8. If measured with TJ-free data input signal. In actual application, output TJ will be given by:

$$TJ_{OUT} = DJ_{IN} + \Delta DJ + \sqrt{(TJ_{IN} - DJ_{IN})^2 + (\Delta TJ - \Delta DJ)^2}$$

IV. Optical Characteristics ($T_{OP} = -40$ to 85 °C, $V_{CC} = 3.0$ to 3.6 Volts)

Parameter	Symbol	Min	Typ	Max	Unit	Ref.
Transmitter						
Output Opt. Pwr: 50 or 62.5 MMF	P_{OUT}	-9		-2.5	dBm	1
Optical Wavelength	λ	830		860	nm	
Spectral Width	σ			0.85	nm	
Optical Modulation Amplitude	OMA_{TX}	196			μ W	2
Optical Rise/Fall Time	t_r/ t_f			150	ps	3
Relative Intensity Noise	RIN			-120	dB/Hz	
Deterministic Jitter Contribution (p-p)	$TX \Delta DJ$		20	56.5	ps	4
Total Jitter Contribution (p-p)	$TX \Delta TJ$			119	ps	5
Extinction Ratio @ 1.25 Gb/s	ER	9			dB	
Mask Margin			45%			
Receiver						
Receiver Sensitivity = 1.0625 Gb/s	RX_{SENS}			-20	dBm	6
Receiver Sensitivity = 2.125 Gb/s	RX_{SENS}			-18	dBm	6
Receiver Sensitivity = 1.25 Gb/s	RX_{SENS}			-20	dBm	7
Stressed RX sens. = 1.0625 Gb/s		0.055			mW	8
Stressed RX sens. = 2.125 Gb/s		0.096			mW	8
Stressed RX sens = 1.25 Gb/s				-13.5	dBm	9
Average Received Power	RX_{MAX}			0	dBm	
Receiver Elec. 3 dB cutoff freq.				1500	MHz	
Optical Center Wavelength	λ_C	770		860	nm	
Return Loss	RL	12			dB	
Signal Detect Normal	SD_{normal}			-20	dBm	
Signal Detect Fault	SD_{fault}	-30			dBm	
Signal Detect Hysteresis		0.5			dB	

Notes:

- Class 1 Laser Safety per FDA/CDRH, EN (IEC) 60825 laser safety regulations.
- Equivalent extinction ratio specification for Fibre Channel. Allows smaller ER at higher average power.
- Unfiltered, 20-80%. Complies with FC 1x and 2x eye mask when filtered.
- Measured with DJ-free data input signal. In actual application, output DJ will be the sum of input DJ and ΔDJ .
- If measured with TJ-free data input signal. In actual application, output TJ will be given by:

$$TJ_{OUT} = DJ_{IN} + \Delta DJ + \sqrt{(TJ_{IN} - DJ_{IN})^2 + (\Delta TJ - \Delta DJ)^2}$$

- Specifications are for 50 micro-meter or 62.5 micro-meter fiber
- As measured with 9dB extinction ratio.
- Measured with conformance signals defined in FC-PI-2 Rev. 7.0 specifications.
- Measured with conformance signals defined in IEEE 802.3 specifications.

V. General Specifications

Parameter	Symbol	Min	Typ	Max	Units	Ref.
Data Rate	BR		1.062, 1.25 2.125		Gb/sec	1
Bit Error Rate	BER			10 ⁻¹²		4
Fiber Length on 50/125µm MMF	L			500 300	m	2 3
Fiber Length on 62.5/125µm MMF	L			300 150	m	2 3

Notes:

1. Gigabit Ethernet and 1x, 2x Fibre Channel compatible per IEEE 802.3 and FC-PI-2 Rev. 7.0 respectively. Typical maximum data rate extends to 2.5Gb/s.
2. At 1.0625 Gb/s Fibre Channel and 1.25 Gb/s Gigabit Ethernet data rates.
3. At 2.125 Gb/s Fibre Channel data rate.
4. At 1.0625, 1.25, and 2.125Gb/s with PRBS 2⁷-1.

VI. Environmental Specifications

FTLF8519F2xTL SFF transceivers have an industrial operating temperature range from -40°C to +85°C case temperature.

Parameter	Symbol	Min	Typ	Max	Units	Ref.
Case Operating Temperature	T _{op}	-40		85	°C	
Storage Temperature	T _{sto}	-40		85	°C	

Notes:

1. SFF transceivers may be water washed. However, the process must be followed by a baking step at 80°C for one hour, to ensure the drying of any water which may be trapped inside then shells of the modules.

VII. Regulatory Compliance

Finisar transceivers are Class 1 Laser Products and comply with US FDA regulations. These products are certified by TÜV and CSA to meet the Class 1 eye safety requirements of EN (IEC) 60825 and the electrical safety requirements of EN (IEC) 60950. Copies of certificates are available at Finisar Corporation upon request.

VIII. Mechanical Specifications

Finisar’s Small Form Factor (SFF) transceivers comply with the standard dimensions defined by the Small Form Factor Multi-Sourcing Agreement (MSA).

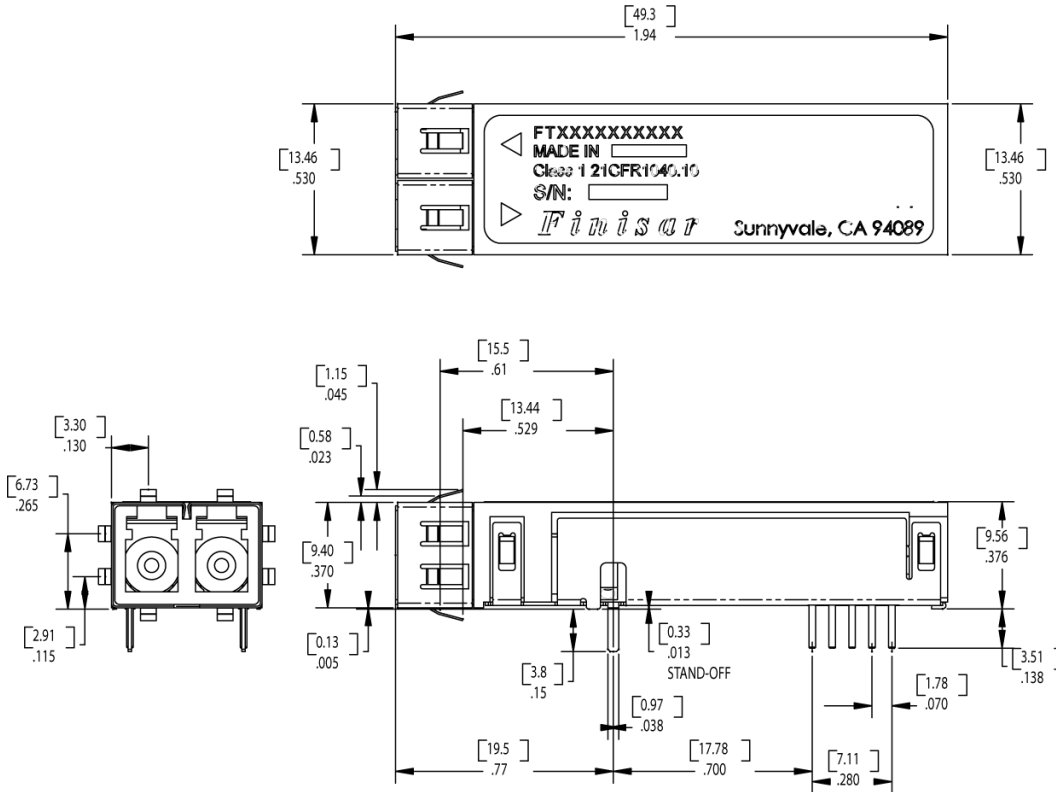

FTLF8519F2GTL

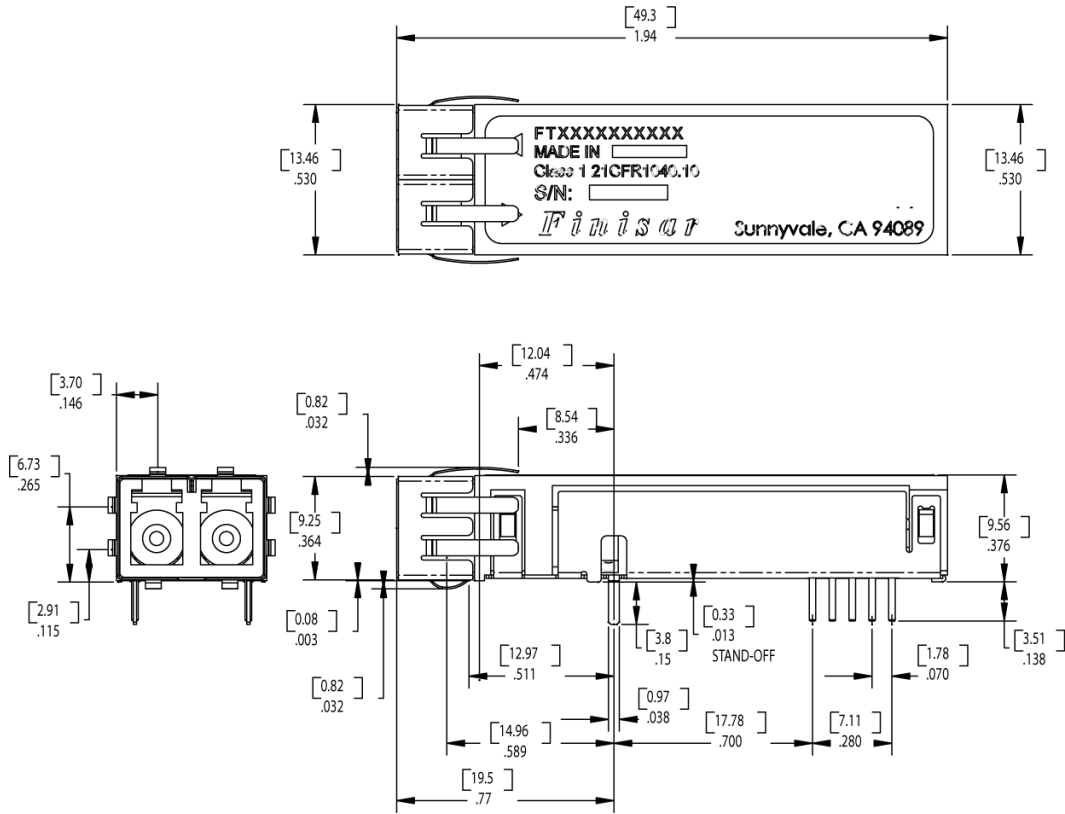

FTLF8519F2KTL

IX. PCB Layout and Bezel Recommendations

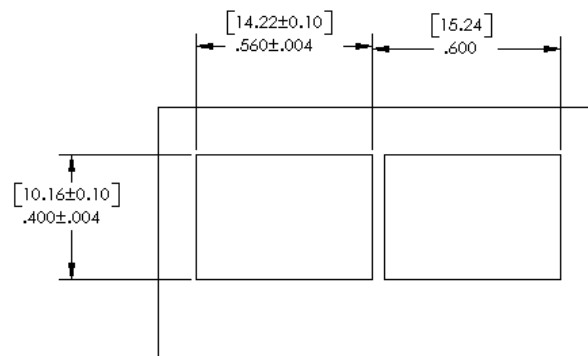
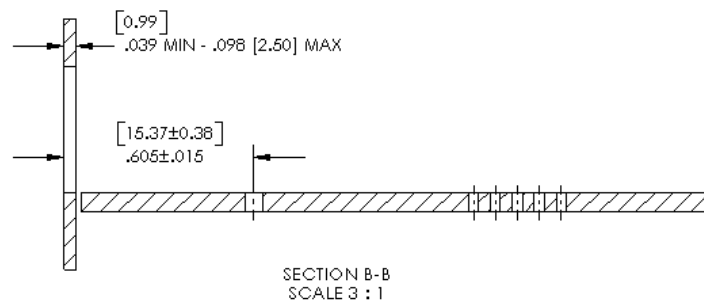
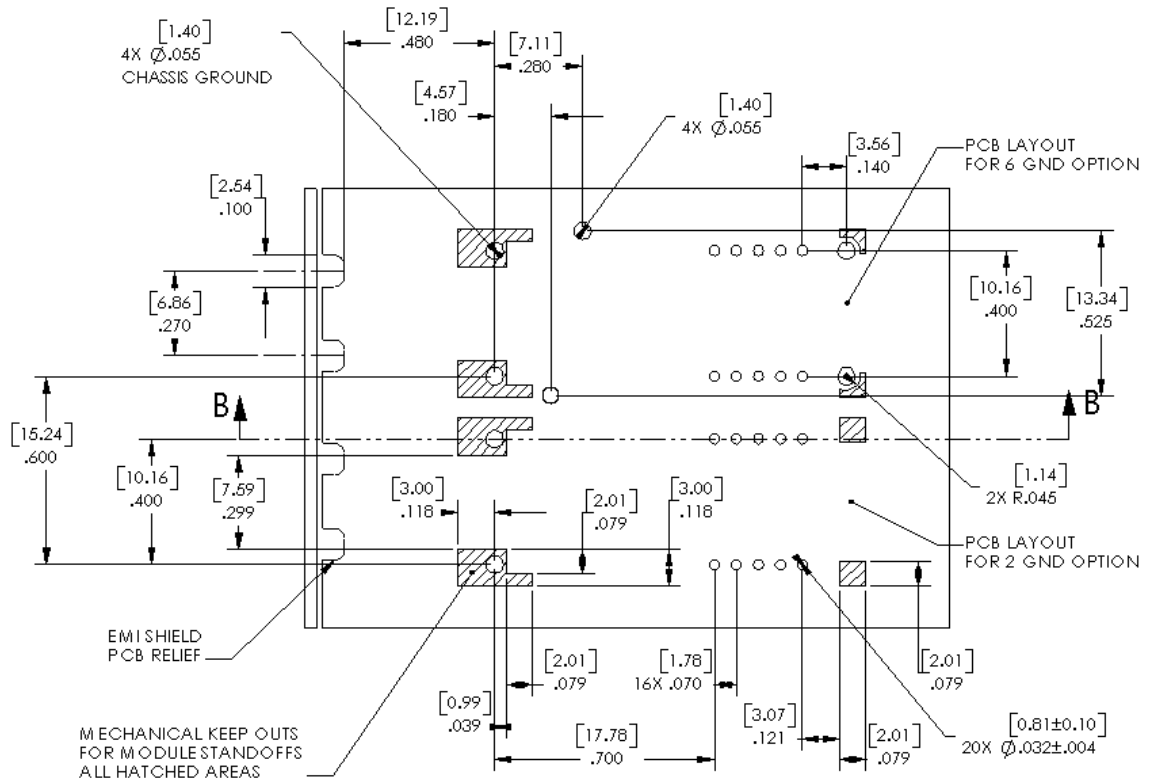

Minimum Recommended Pitch is 0.600"

X. References

1. Small Form Factor (SFF) Transceiver Multi-source Agreement (MSA). July 5, 2000.
2. IEEE Std 802.3, 2002 Edition, Clause 38, PMD Type 1000BASE-SX.
IEEE Standards Department, 2002.
3. “Fibre Channel Draft Physical Interface Specification (FC-PI-2 Rev. 7.0)”. American National Standard for Information Systems.
4. Directive 2002/95/EC of the European Council Parliament and of the Council, “on the restriction of the use of certain hazardous substances in electrical and electronic equipment.” January 27, 2003.
5. Small Form-factor Pluggable (SFP) Transceiver Multi-source Agreement (MSA), September 14, 2000.

XI. For More Information

Finisar Corporation
1308 Moffett Park Drive
Sunnyvale, CA 94089-1133
Tel. 1-408-548-1000
Fax 1-408-541-6138
sales@finisar.com
www.finisar.com