

# M0116SD-161SDBR1-S

## Vacuum Fluorescent Display Module

RoHS Compliant

**Newhaven Display International, Inc.**

2511 Technology Drive, Suite 101

Elgin IL, 60124

Ph: 847-844-8795

Fax: 847-844-8796

[www.newhavendisplay.com](http://www.newhavendisplay.com)

[nhtech@newhavendisplay.com](mailto:nhtech@newhavendisplay.com)

[nhsales@newhavendisplay.com](mailto:nhsales@newhavendisplay.com)

## 1.SCOPE

This specification applies to VFD module M0116SD-161SDBR1-S.

## 2.FEATURES

- 2.1.Construction: Single board display module consists of 16 character (1\*16) VFD, VFD controller, DC/DC converter and all necessary control circuitry.
- 2.2. This module can be controlled by the host with three control signals, SEL, SLK, SDATA.
- 2.3. Since a DC/DC converter is used. Power source (5Vdc) is required to operate the module.
- 2.4. Characters are provided with a 5\*7 dot matrix.
- 2.5. This module has 200 characters in Build-in character generator. The user definable fonts(UDF) can be programable up to 8 characters.

## 3. PRODUCT SPECIFICATIONS

### 3.1.Outer Dimensions of PCB

Parameter	Specification
Width	100(mm)
Height	28 (mm)
Thickness	1.6 (mm)

### 3.2. Specifications of Display Panel

Parameter	Specification	Unit
Display Size (W*H)	61.8*5.1	mm
Number of Digit	16 Digits	
Character Size (W*H)	2.55 * 5.1	mm
Color of illumination	Green	

### 3.3. Environment Condition

Parameter	Min	Max	Unit
Operating Temperature	-40	+85	
Storage Temperature	-50	+95	
Humidity (Operating)	20	80	%
Humidity (Non-operating)	0	90	%
Vibration (10 ~ 55 Hz)	-	10	G
Shock	-	100	G

### 3.4. Absolute Maximum Ratings

Parameter	Symbol	Min	Typ	Max	Unit
Supply Voltage	VCC	0	5.0	7.0	VDC
Input Signal Voltage	VI	0	-	5.5	VDC

### 3.5. Recommend Operating Conditions(Ta=-10 ~ 70°C unless otherwise noted)

Parameter		Symbol	Min.	Typ.	Max.	Unit	Condition	
Logic Input Voltage	SDATA	High-level input voltage	VIH	2.0	-	-	VDC	VCC=5.0V
		Low-level input voltage	VIL	-	-	0.8	VDC	VCC=5.0V
	RESET CS SCK	Positive-going threshold voltage	VT+	1.75	2.8	3.5	VDC	VCC=5.0V
		Negative-going threshold voltage	VT-	1.0	2.0	2.75	VDC	VCC=5.0V
Power Supply Voltage		VCC	4.75	5.00	5.25	VDC	-	
Power Supply Current		ICC	-	250	320	mADC	All dots "ON"	

Slow start power supply may cause erroneous operation.

ICC might be anticipated twice as usual at power on rush.

### 3.6. Pin assignment

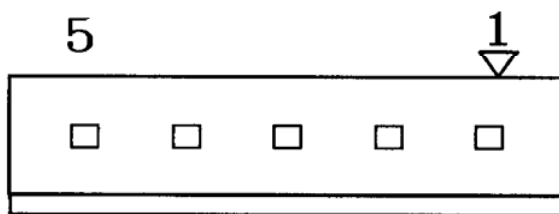

No.	Signal
1	Vcc
2	GND
3	CS
4	CLK
5	DATA

Fig-3. Connector Description

### 3.6. VFD Grid Assignment And Dimension

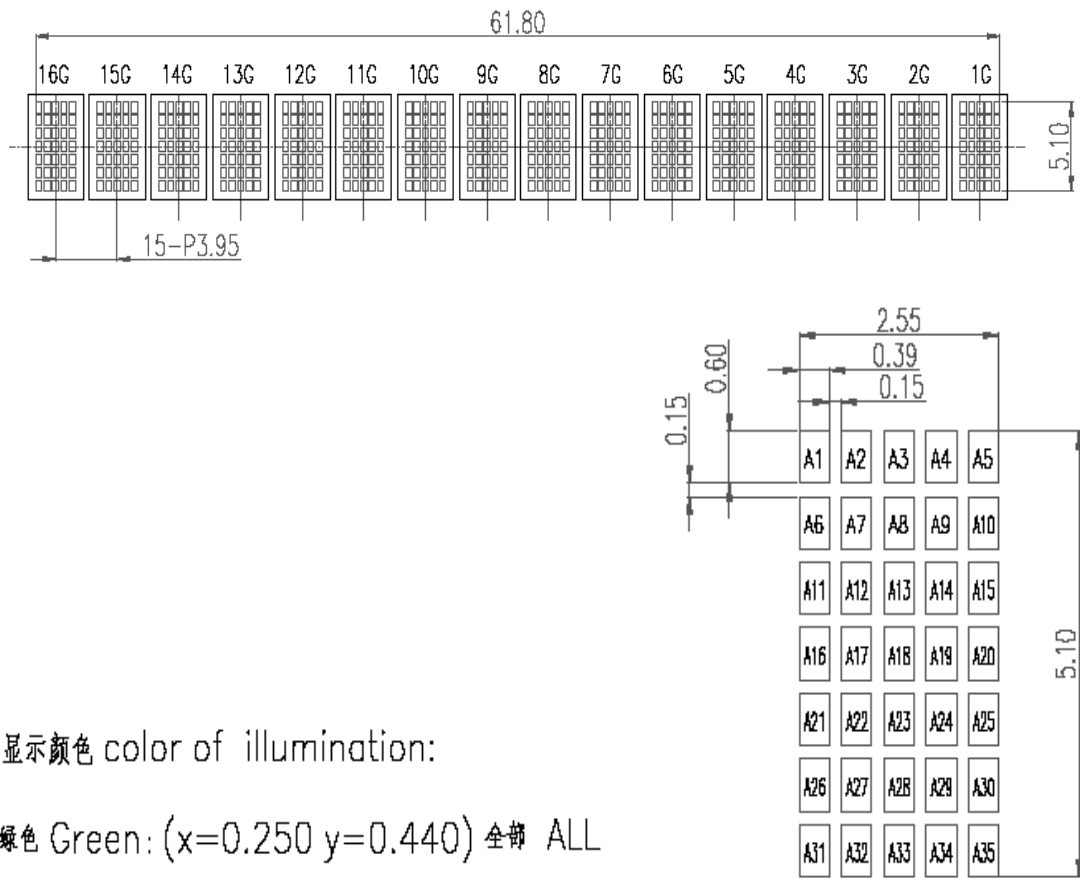

显示颜色 color of illumination:

绿色 Green: (x=0.250 y=0.440) 全部 ALL

Fig-4. VFD dimension and grid assignment

### 3.7. Outer Dimensions (Front panel, Structure outline)

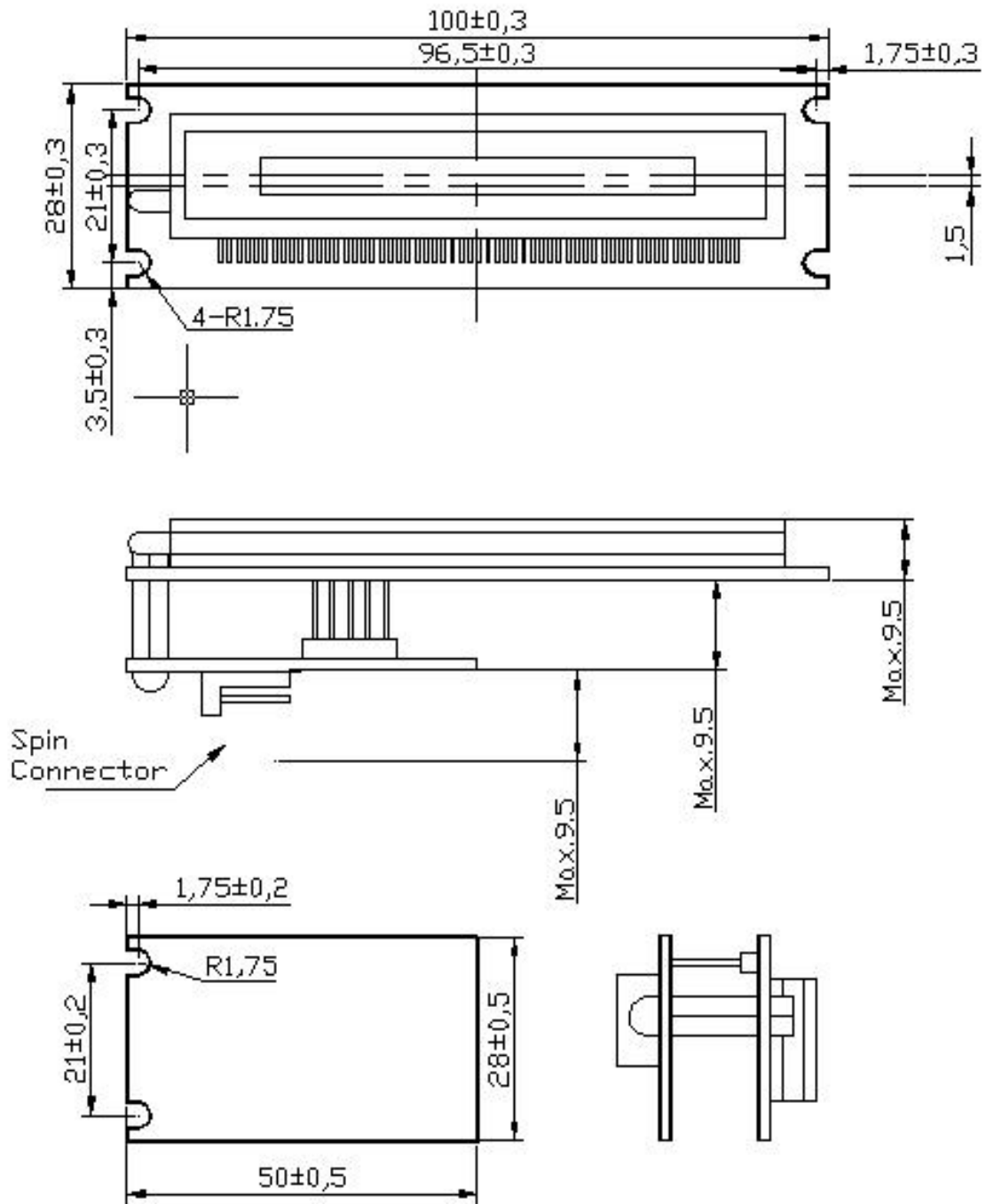

Fig-5. Outer Dimensions (Structure outline)

## 4. FUNCTION DESCRIPTIONS

### 4.1. Command Description:

Function	Command Data								Contents
	D7	D6	D5	D4	D3	D2	D1	D0	
Set display length	0	0	0	0	0	*	*	*	Set the maximum number of digit to be displayed. (9 to 16 digits)
Set dimmer value	0	0	0	0	1	*	*	*	Adjust the brightness. (8 steps)
Set digit pointer	1	1	1	0	*	*	*	*	This command is used to select a digit to display a character which is received as a character code data.
Automatic increment mode ON/OFF of digit pointer	1	1	1	1	0	1	0	*	When "ON", the digit pointer is advanced automatically after receiving a character code data. When "OFF", the digit pointer is fixed.
Display all ON/OFF	1	1	1	1	0	0	*	*	All dot outputs can be set "ON".
Storing data in UDF	1	1	1	1	1	1	X	X	This command is a declaration to define a UDF.

X : Don't care      \* : Selection bits      "0" : Low – level      "1" : High – level

There is no 0xF6 function to set digit scan time,

If a command undefined sends to the module, there will nothing happens.

#### 4.1.1. Set: display length:

D7	D6	D5	D4	D3	D2	D1	D0
0	0	0	0	0			

Maxium number of digit to be displayed  
(See Table 1)

#### 4.1.2. Set digit dimmer value:

D7	D6	D5	D4	D3	D2	D1	D0
0	0	0	0	1			

Dimmer value (See Table 2)

Table1 Maximum number of digit

D2	D1	D0	Maximum number of digit
0	0	0	9
0	0	1	10
0	1	0	11
0	1	1	12
1	0	0	13
1	0	1	14
1	1	0	15
1	1	1	16

Table2 Dimmer value

D2	D1	D0	Dimmer value (Tdig/Tdsp)
0	0	0	1/16
0	0	1	2/16
0	1	0	4/16
0	1	1	6/16
1	0	0	8/16
1	0	1	10/16
1	1	0	12/16
1	1	1	14/16

Tdig : Digit "ON" time

Tdsp : scan time

4.1.3. Set digit point:

D7	D6	D5	D4	D3	D2	D1	D0
1	1	1	0				

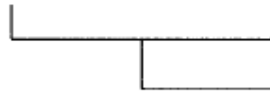

Digit select (See Note 1)

(Note 1) :

0,0,0,0(D3,D2,D1,D0) : digit pointer sets left most position

1,1,1,1(D3,D2,D1,D0) : digit pointer sets right most position

4.1.4. Auto increment mode ON/OFF:

D7	D6	D5	D4	D3	D2	D1	D0
1	1	1	1	0	1	0	

"0" : Automatic Increment mode "OFF"  
 "1" : Automatic increment mode "ON"

#### 4.1.5. Display all ON/OFF:

D7	D6	D5	D4	D3	D2	D1	D0
1	1	1	1	0	0		



 See Table 3

Table 3 Display mode selection

D1	D0	Function
X	0	All digits, all dots "OFF"
0	1	Normal display mode
1	1	All digits, all dots "ON"

X : Don't care

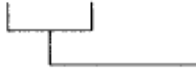
#### 4.1.6. Storing data in UDF:

The following 3 steps define UDF to RA1~RA8

The 1<sup>st</sup>. is the declaration to define UDF. (1 byte command)

The 2<sup>nd</sup>. Is the selection of a UDF character code number. (1 byte command)

And the 3<sup>rd</sup>. is the data set of the font. (5 byte command)

Therefore, to design user font to UDF, continuous cp., ands of 7 bytes are need.

The UDF character code of RA1 TO RA8 are assigned to 00(Hex) to 07(Hex).

##### 1st. byte The Declaration

D7	D6	D5	D4	D3	D2	D1	D0
1	1	1	1	1	1	X	X

X : Don't care

##### 2nd. byte UDF character code select

D7	D6	D5	D4	D3	D2	D1	D0
X	X	X	X	0			

X : Don't care

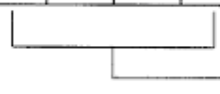

 Lower 3-bit of UDF code to be defined.



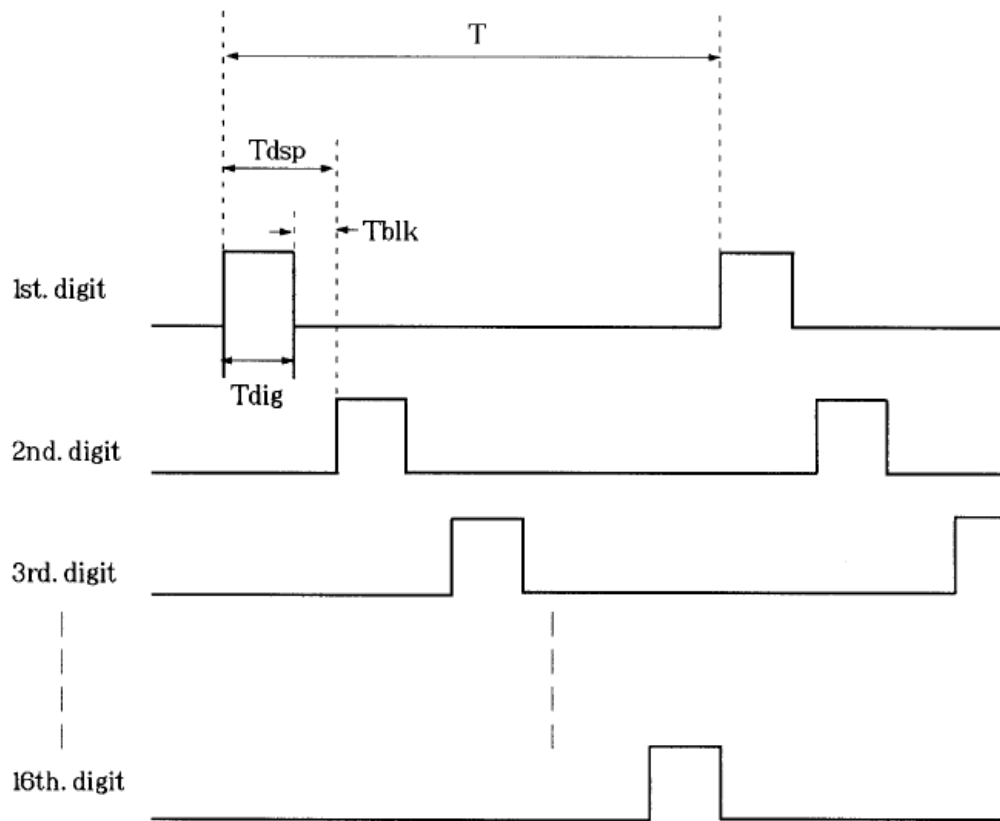

## 4.2.2. Display scan timing

(Scan timing chart)



T : Frame cycle time      Tdsp : Digit scan time  
Tdig : Digit "ON" time      Tblk : Blank time

T=4.096ms      Tdsp=256us      Tdig=240us      Tblk=16us

### 4.2.3.Character Display Operation

There are two modes, one is automatic increment "ON" mode, the other is automatic increment"OFF" mode.

In automatic increment "ON" mode, the digit pointer, which indicates the digit to display a character from HOST, is advanced every time after displaying the character. After displaying on the upper most digit, the pointer returns to lowest digit.

In automatic increment "OFF", the digit pointer is fixed. Therefore, the received character is displayed on the same digit.

Sequence	serial data	Front view of VFD	Remarks
		1 2 3 4 5 6 7 8 9 10 11	
1	F5 (Hex)	<input type="text"/> <input type="text"/> <input type="text"/> <input type="text"/> <input type="text"/> <input type="text"/> <input type="text"/> <input type="text"/> <input type="text"/> <input type="text"/> <input type="text"/> <input type="text"/>	Set automatic increment "ON"
2	E0 (Hex)	<input type="text"/> <input type="text"/> <input type="text"/> <input type="text"/> <input type="text"/> <input type="text"/> <input type="text"/> <input type="text"/> <input type="text"/> <input type="text"/> <input type="text"/> <input type="text"/>	Set digit pointer to GRID#1
3	43 (Hex)	C <input type="text"/> <input type="text"/> <input type="text"/> <input type="text"/> <input type="text"/> <input type="text"/> <input type="text"/> <input type="text"/> <input type="text"/> <input type="text"/> <input type="text"/> <input type="text"/>	code of "C"
4	55 (Hex)	C U <input type="text"/> <input type="text"/> <input type="text"/> <input type="text"/> <input type="text"/> <input type="text"/> <input type="text"/> <input type="text"/> <input type="text"/> <input type="text"/> <input type="text"/> <input type="text"/>	"U"
5	31 (Hex)	C U I <input type="text"/> <input type="text"/> <input type="text"/> <input type="text"/> <input type="text"/> <input type="text"/> <input type="text"/> <input type="text"/> <input type="text"/> <input type="text"/> <input type="text"/> <input type="text"/>	"I"
6	36 (Hex)	C U I 6 <input type="text"/> <input type="text"/> <input type="text"/> <input type="text"/> <input type="text"/> <input type="text"/> <input type="text"/> <input type="text"/> <input type="text"/> <input type="text"/> <input type="text"/> <input type="text"/>	"6"
7	35 (Hex)	C U I 6 5 <input type="text"/> <input type="text"/> <input type="text"/> <input type="text"/> <input type="text"/> <input type="text"/> <input type="text"/> <input type="text"/> <input type="text"/> <input type="text"/> <input type="text"/> <input type="text"/>	"5"
8	45 (Hex)	C U I 6 5 E <input type="text"/> <input type="text"/> <input type="text"/> <input type="text"/> <input type="text"/> <input type="text"/> <input type="text"/> <input type="text"/> <input type="text"/> <input type="text"/> <input type="text"/> <input type="text"/>	"E"
9	43 (Hex)	C U I 6 5 E C <input type="text"/> <input type="text"/> <input type="text"/> <input type="text"/> <input type="text"/> <input type="text"/> <input type="text"/> <input type="text"/> <input type="text"/> <input type="text"/> <input type="text"/> <input type="text"/>	"C"
10	50 (Hex)	C U I 6 5 E C P <input type="text"/> <input type="text"/> <input type="text"/> <input type="text"/> <input type="text"/> <input type="text"/> <input type="text"/> <input type="text"/> <input type="text"/> <input type="text"/> <input type="text"/> <input type="text"/>	"P"
11	F4 (Hex)	C U I 6 5 E C P <input type="text"/> <input type="text"/> <input type="text"/> <input type="text"/> <input type="text"/> <input type="text"/> <input type="text"/> <input type="text"/> <input type="text"/> <input type="text"/> <input type="text"/> <input type="text"/>	Set automatic increment "OFF"
12	E5 (Hex)	C U I 6 5 E C P <input type="text"/> <input type="text"/> <input type="text"/> <input type="text"/> <input type="text"/> <input type="text"/> <input type="text"/> <input type="text"/> <input type="text"/> <input type="text"/> <input type="text"/> <input type="text"/>	Set digit pointer to GRID#6
13	53 (Hex)	C U I 6 5 S C P <input type="text"/> <input type="text"/> <input type="text"/> <input type="text"/> <input type="text"/> <input type="text"/> <input type="text"/> <input type="text"/> <input type="text"/> <input type="text"/> <input type="text"/> <input type="text"/>	code of "S"
14	4D (Hex)	C U I 6 5 M C P <input type="text"/> <input type="text"/> <input type="text"/> <input type="text"/> <input type="text"/> <input type="text"/> <input type="text"/> <input type="text"/> <input type="text"/> <input type="text"/> <input type="text"/> <input type="text"/>	"M"
15	45 (Hex)	C U I 6 5 E C P <input type="text"/> <input type="text"/> <input type="text"/> <input type="text"/> <input type="text"/> <input type="text"/> <input type="text"/> <input type="text"/> <input type="text"/> <input type="text"/> <input type="text"/> <input type="text"/>	"E"

### 4.2.4.Character Display Operation

All digits and dots turn "ON" or "OFF" at a time by the command of display all ON/OFF command.

The written data in the module is not changed even in the state of display all "ON" or all "OFF", and any command and character code data from HOST are effective.

#### 4.3. Initialization

The power on reset function allows the users to re-initialize the display controller, after the power is turned off and then power on.

When the controller is initialized, the display status is given below

1. Address of each RAM : Address "00" H
2. Data of each RAM : All contents are undefined
3. Display Digit : 16 Digits
4. All Display Light : OFF Mode
5. Segment Output : All Segment Outputs are set to "LOW"
6. Digit Dimmer Value : 8/16

#### 4.4. Timing chart

##### 4.4.1 Data write timing

The data shall be written from D7(MSB) to D0(LSB). The data is fetched when the Serial clock goes from Low to High.

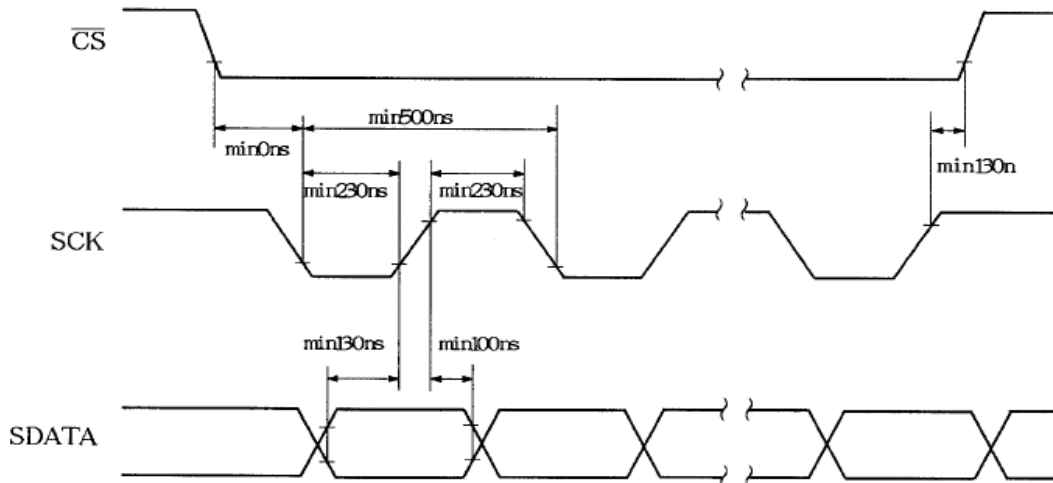

##### 4.4.2 Busy timing

This shows the internal operation time after receiving the serial data. Next data is prohibited in this period. Next data is available after 6T of the operation clock (about 500~4000ns)

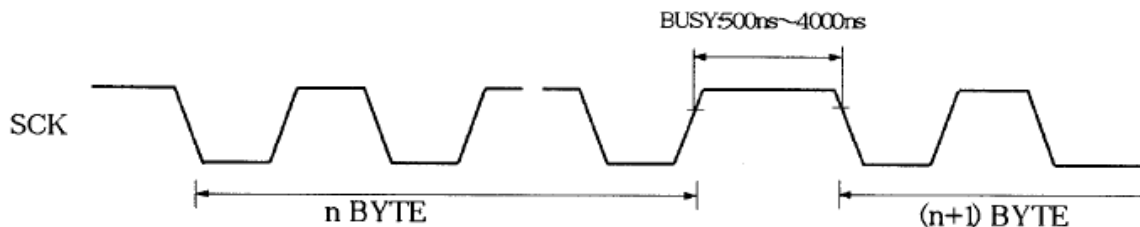

#### 4.4. Recommend Initial setting sequence

After reset, the module must be set according to the Initial Setting Flowchart shown below.

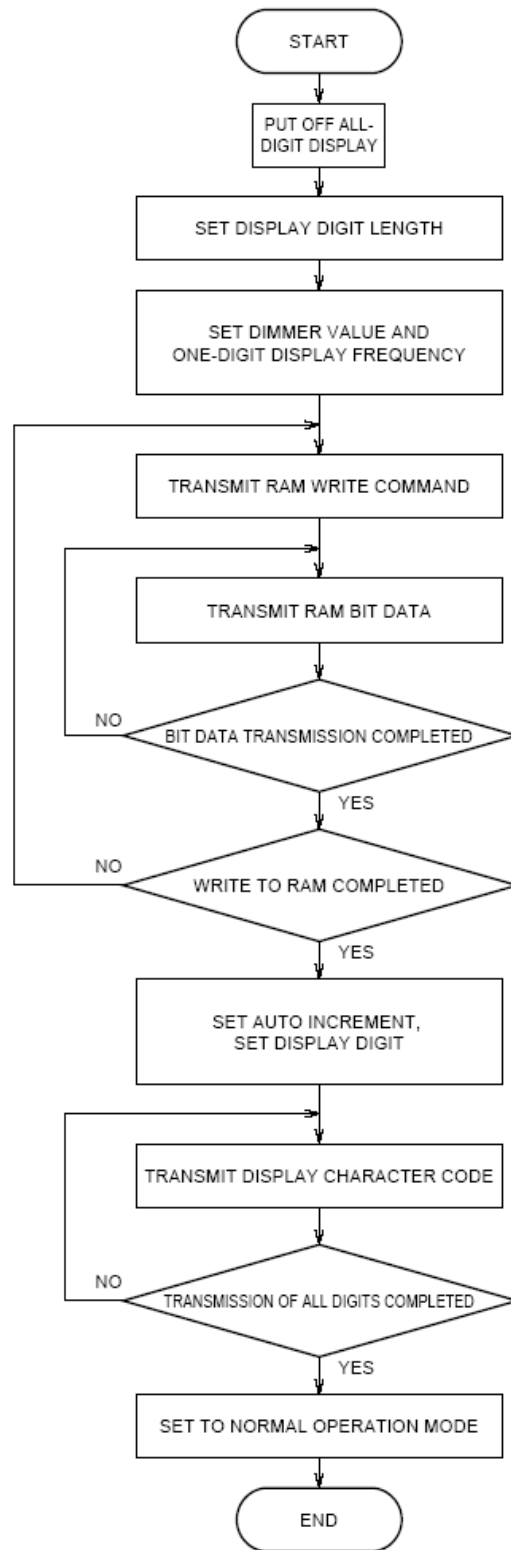

### 4.5 Font Table

MSB LSB		0000	0001	0010	0011	0100	0101	0110	0111	1000	1001	1010	1011	1100	1101	1110	1111
0000	RAM0	U		O	P	P	P	P	P								
0001	RAM1	U	!	A	Q	Q	Q	Q	Q								
0010	RAM2	U	"	B	R	R	R	R	R								
0011	RAM3	U	#	C	S	S	S	S	S								
0100	RAM4	U	\$	D	T	T	T	T	T								
0101	RAM5	U	%	E	U	U	U	U	U								
0110	RAM6	U	&	F	W	W	W	W	W								
0111	RAM7	U	'	G	W	W	W	W	W								
1000		U	(	H	X	X	X	X	X								
1001		U	)	I	Y	Y	Y	Y	Y								
1010		U	*	J	Z	Z	Z	Z	Z								
1011		U	+	K	L	L	L	L	L								
1100		U	,	X	I	I	I	I	I								
1101		U	-	M	J	J	J	J	J								
1110		U	.	X	N	N	N	N	N								
1111		U	/	O	L	L	L	L	L								