

User's Guide

D120MY-20-2002

VFD- RoHS Compliant

(Vacuum Fluorescent Display Module)

For product support, contact

Newhaven Display International
2511 Technology Drive, #101
Elgin, IL 60124

Tel: (847) 844-8795 Fax: (847) 844-8796

February 26, 2008

Vacuum Fluorescent Display Specification

PART NUMBER: D0120MY-20-2002

FEATURES: 20 Digits, Alphanumeric

APPLICATION: Character Display (*Alphanumeric*)

RATINGS: Below

Outer Dimensions	Panel Length	P.L.	134.0	mm	
	Panel Height	P.H.	20.5	mm	
	Panel Thickness	P.T.	6.5	mm	
Leads	Lead Pitch	L.P.	2.54	mm	
	Lead Out	-	SIL		
Character Size	Character Height	C.H.	6.5	mm	
	Character Width	C.W.	3.0	mm	
Item	Symbol	Min.	Recommended	Max.	Unit
Filament Voltage	Ef	5.22	5.8	6.38	Vac
Peak Grid Voltage	ec	-	32.0	39.0	Vp-p
Peak Anode Voltage	eb	-	32.0	39.0	Vp-p
Cut-off Bias	Ek	-	-	-	-
Duty Cycle	Du	-	1/ 24	-	-
Pulse Width	tp	-	100	-	uS
Operating Temperature	Topr	-20	-	+ 70	C
Storage Temperature	Tstg	-55	-	+ 80	C
Color of Illumination	Green				

**Electrical
Characteristics**

Item	Symbol	Test Condition	Min.	Typical	Max.	Unit
Filament Current	if	Ef = 5.8 Vac	54.0	60.0	66.0	mAac
	-	eb = ec = 0	-	-	-	-
Anode Current	ib/1~20G	Ef = 5.6 Vac	-	3.5	7.0	mAp-p
	-	eb = 30.0 Vp-p	-	-	-	mAp-p
	-	ec = 30.0 Vp-p	-	-	-	mAp-p
	-	Du = 1/24	-	-	-	mAp-p
	-	tp = 100 uS	-	-	-	mAp-p
Grid Current	ic/1~20G	All Segs are lit	-	3.5	7.0	mAp-p
	-		-	-	-	mAp-p
	-		-	-	-	mAp-p
	-		-	-	-	mAp-p
	-		-	-	-	mAp-p
Luminance	L(G)		514	1028	-	cd/m ²
	-		(150)	(300)	-	fL
Luminance Ratio	Lmin/Lmax		50	-	-	%
Grid Cut-off Voltage	Ecco	Ef = 5.8 Vac Eb = 32.0 Vdc	-7.0	-	-	Vdc
Anode Cut-off Voltage	Ebco	Ef = 5.8 Vac ec = 32.0 Vp-p Du = 1/24 tp = 100 uS	-4.0	-	-	Vdc

* Drive Mode is Dynamic State

Outline Drawing (Unit:mm)

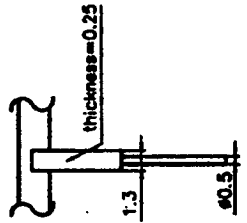
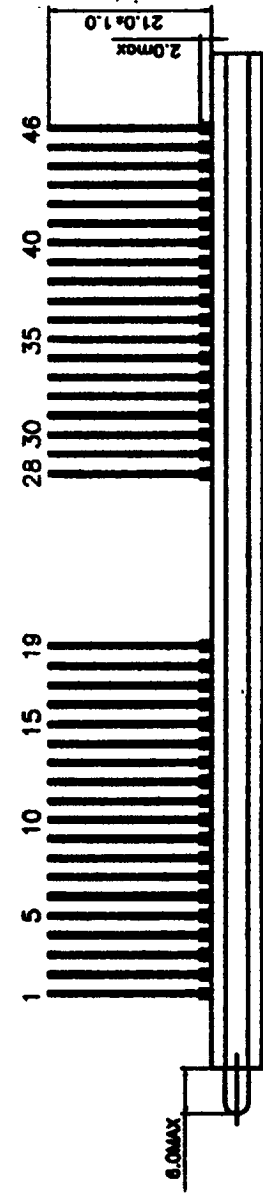
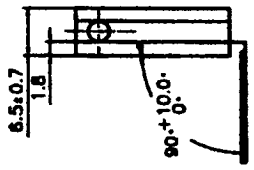
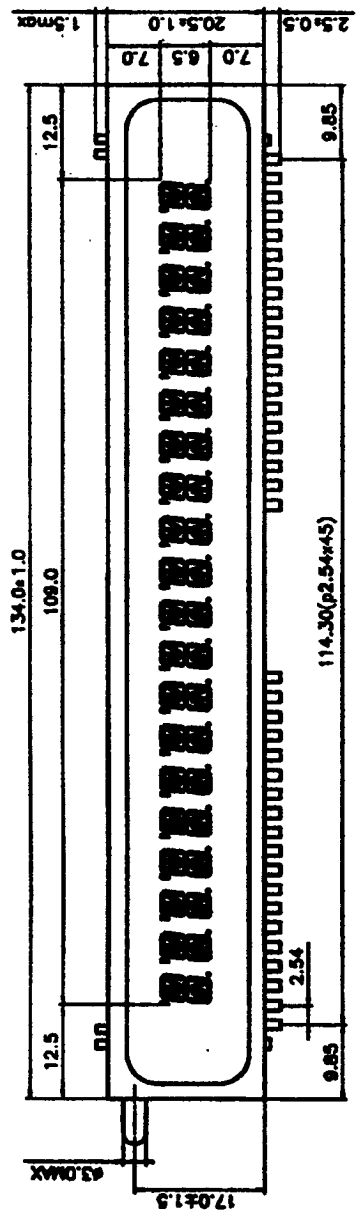

LEAD DETAILS

PIN CONNECTION

端子序号	TERMINAL NO.	1	2	3	4	5	6	7	8	9	10	11	12	13	14	15	16	17	18	19	20	21	22	23
连接	ELECTRODE	F	P1	P2	P3	P4	P5	P6	P7	P8	20G	19G	18G	17G	16G	15G	14G	13G	12G	11G	NP	NP	NP	NP
端子序号	TERMINAL NO.	24	25	26	27	28	29	30	31	32	33	34	35	36	37	38	39	40	41	42	43	44	45	46
连接	ELECTRODE	NP	NP	NP	NP	10G	9G	8G	7G	6G	5G	4G	3G	2G	1G	P9	P10	P11	P12	P13	P14	P15	P16	F

NOTE: F: Filament G: Grid P: Anode NP: No pin

Display Pattern and Grid Assignment

20G

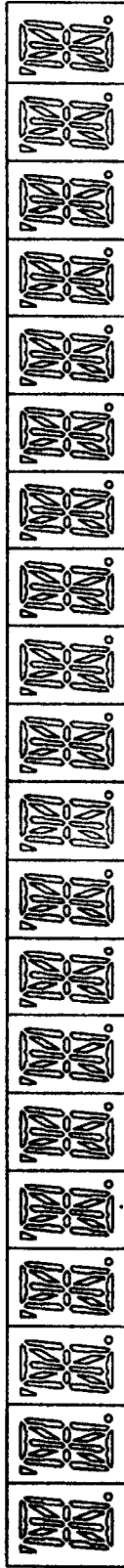

1G

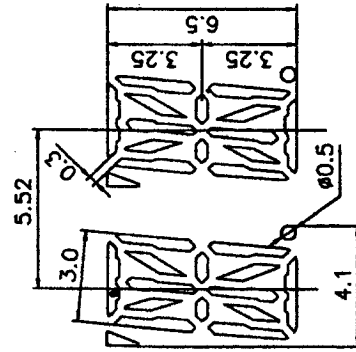
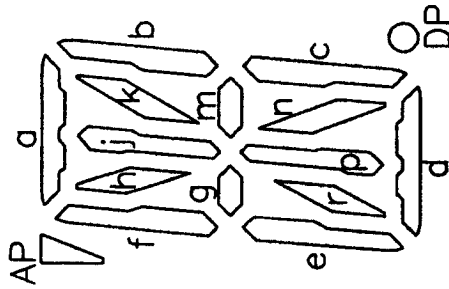

COLOR OF ILLUMINATION

Green (G:x=0.250,y=0.440)

Anode Connection

	1G	2G	3G	4G	5G	6G	7G	8G	9G	10G	11G	12G	13G	14G	15G	16G	17G	18G	19G	20G	
P1	f	f	f	f	f	f	f	f	f	f	f	f	f	f	f	f	f	f	f	f	f
P2	g	g	g	g	g	g	g	g	g	g	g	g	g	g	g	g	g	g	g	g	g
P3	e	e	e	e	e	e	e	e	e	e	e	e	e	e	e	e	e	e	e	e	e
P4	r	r	r	r	r	r	r	r	r	r	r	r	r	r	r	r	r	r	r	r	r
P5	n	n	n	n	n	n	n	n	n	n	n	n	n	n	n	n	n	n	n	n	n
P6	p	p	p	p	p	p	p	p	p	p	p	p	p	p	p	p	p	p	p	p	p
P7	DP	DP	DP	DP	DP	DP	DP	DP	DP	DP	DP	DP	DP	DP	DP	DP	DP	DP	DP	DP	DP
P8	d	d	d	d	d	d	d	d	d	d	d	d	d	d	d	d	d	d	d	d	d
P9	c	c	c	c	c	c	c	c	c	c	c	c	c	c	c	c	c	c	c	c	c
P10	m	m	m	m	m	m	m	m	m	m	m	m	m	m	m	m	m	m	m	m	m
P11	b	b	b	b	b	b	b	b	b	b	b	b	b	b	b	b	b	b	b	b	b
P12	h	h	h	h	h	h	h	h	h	h	h	h	h	h	h	h	h	h	h	h	h
P13	k	k	k	k	k	k	k	k	k	k	k	k	k	k	k	k	k	k	k	k	k
P14	j	j	j	j	j	j	j	j	j	j	j	j	j	j	j	j	j	j	j	j	j
P15	AP	AP	AP	AP	AP	AP	AP	AP	AP	AP	AP	AP	AP	AP	AP	AP	AP	AP	AP	AP	AP
P16	a	a	a	a	a	a	a	a	a	a	a	a	a	a	a	a	a	a	a	a	a