

**BRIGHT RED MST6111C, MST6141C
GREEN MST6411C, MST6441C
HIGH EFF. RED MST6911C, MST6941C**

PACKAGE DIMENSIONS

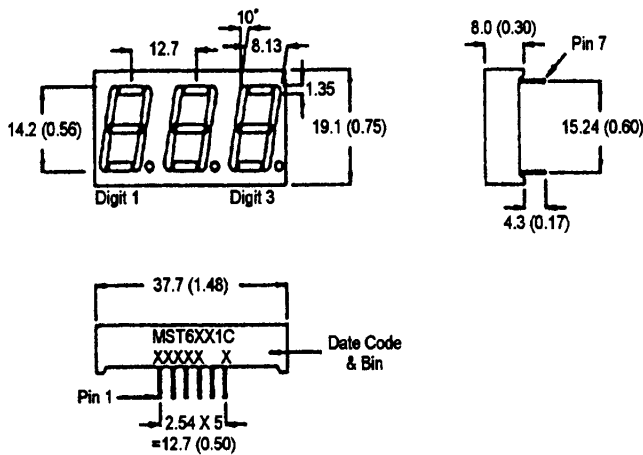

**NOTES: Dimensions are in mm (inch).
All pins are 0.5 (0.02) diameter
Tolerances are ± 0.25 (0.1) unless otherwise noted.**

FEATURES

- Easy to read digit
- Common anode or cathode
- Low power consumption
- Highly visible bold segments
- High brightness with high contrast
- White segments on a grey face for MST64X1C and MST61X1C.
- Red segments and red face for MST69X1C
- Directly compatible with integrated circuits
- Rugged plastic/epoxy construction

APPLICATIONS

- Digital readout displays
- Instrument panels

MODEL NUMBERS

<u>Part number</u>	<u>Color</u>	<u>Description</u>
MST6111C	Bright Red	Common Anode; right hand decimal
MST6141C	Bright Red	Common Cathode; right hand decimal
MST6411C	Green	Common Anode; right hand decimal
MST6441C	Green	Common Cathode; right hand decimal
MST6911C	High Efficiency Red	Common Anode; right hand decimal
MST6941C	High Efficiency Red	Common Cathode; right hand decimal

(For other color options, contact your local area Sales Office)

ABSOLUTE MAXIMUM RATING ($T_A=25^\circ\text{C}$ unless otherwise specified)

	B.Red MST 6111C 6141C	Green MST 6411C 6441C	High Eff. Red MST 6911C 6941C	Unit
Part number				
Continuous forward current (I_f) Per Segment	15	30	30	mA
Peak forward current per die (I_p) (at $f = 10.0$ KHz, Duty factor = 1/10)	60	90	90	mA
Power dissipation (P_D)	40*	70*	70*	mW
*Derate Linearly from 25°C	0.17	0.33	0.33	mW/ $^\circ\text{C}$
Reverse voltage per dice.....				5V
Operating and Storage temperature range.....				-25°C to $+85^\circ\text{C}$
Lead soldering time (at 1/16 inch from the bottom of lamp).....				5 seconds @ 230°C

ELECTRO - OPTICAL CHARACTERISTICS ($T_A = 25^\circ\text{C}$ unless otherwise specified)

	Bright Red MST 6111C 6141C	Green MST 6411C 6441C	High Eff. Red MST 6911C 6941C	Test Condition
<u>Part number</u>				
Luminous intensity (ucd)				
minimum	300	800	900	$I_f = 20\text{mA}$
typical	700	2200	2200	$I_f = 20\text{mA}$
Forward voltage (V_f)				
typical	2.1	2.1	2.0	$I_f = 20\text{mA}$
maximum	2.6	2.8	2.8	
Peak wavelength (nm)	697	570	635	$I_f = 20\text{mA}$
Spectral line half width (nm)	90	30	45	$I_f = 20\text{mA}$
Reverse breakdown voltage (V_R)	5	5	5	$I_r = 100\mu\text{A}$

PINOUT

MST6X11C - Common Anode

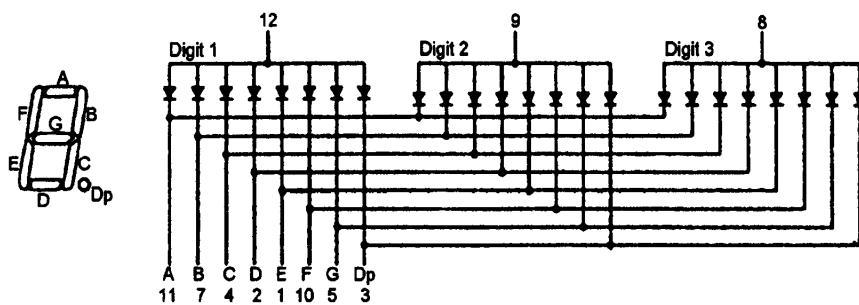

MST6X41C - Common Cathode

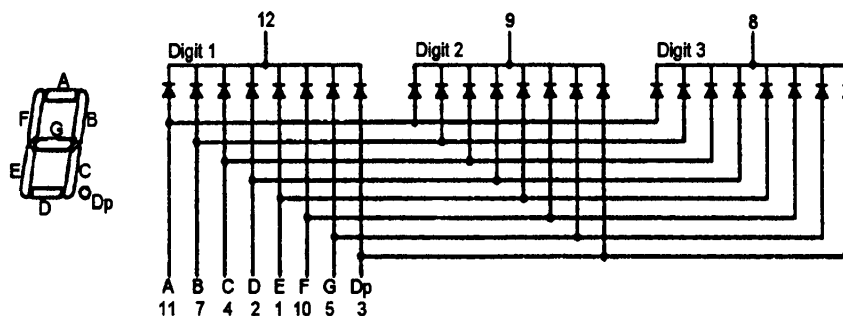

GRAPHICAL DATA - Bright Red ($T_A = 25^\circ\text{C}$ unless otherwise specified)

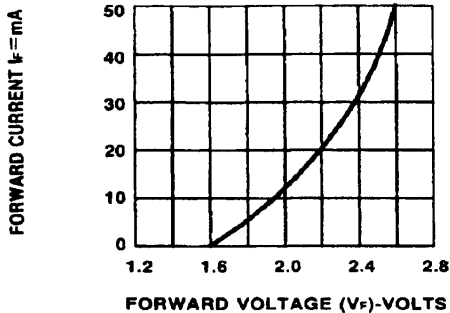

Fig.1 FORWARD CURRENT VS. FORWARD VOLTAGE.

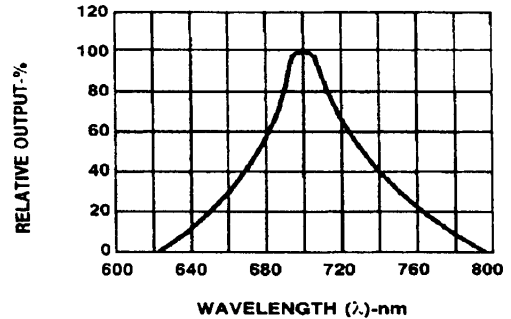

Fig.2 SPECTRAL RESPONSE

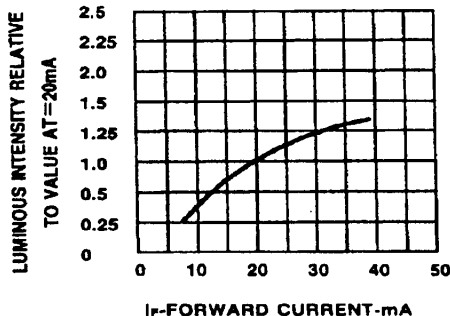

Fig.3 RELATIVE LUMINOUS INTENSITY VS. FORWARD CURRENT

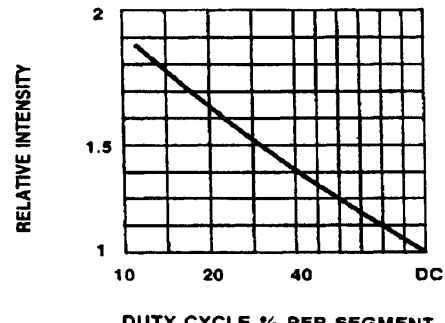

Fig.5 LUMINOUS INTENSITY VS. DUTY CYCLE

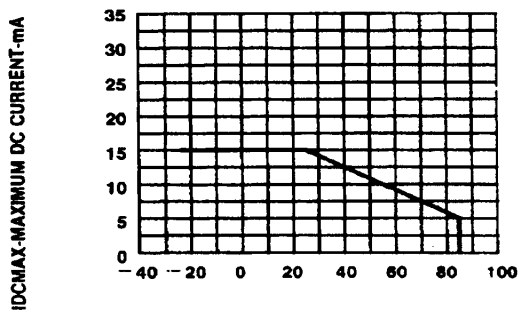

Fig.4 MAXIMUM ALLOWABLE DC CURRENT PER SEGMENT VS. A FUNCTION OF AMBIENT TEMPERATURE.

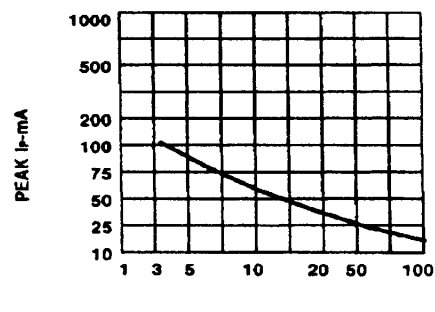

Fig.6 MAX PEAK CURRENT VS. DUTY CYCLE % (REFRESH RATE $f = 1 \text{ KHz}$)

GRAPHICAL DATA - Green ($T_A = 25^\circ\text{C}$ unless otherwise specified)

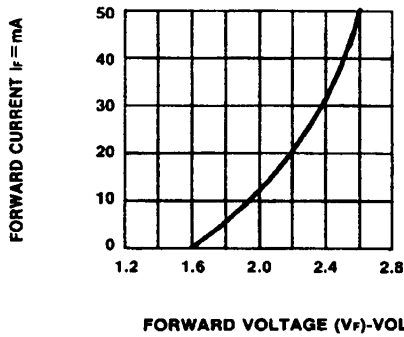

Fig.1 FORWARD CURRENT VS. FORWARD VOLTAGE.

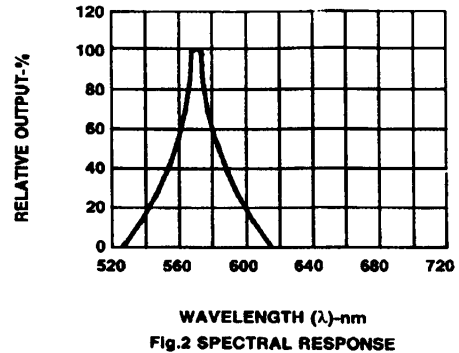

Fig.2 SPECTRAL RESPONSE

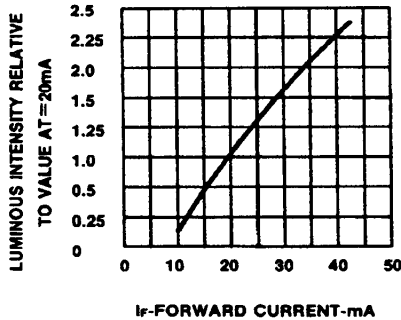

Fig.3 RELATIVE LUMINOUS INTENSITY VS. FORWARD CURRENT

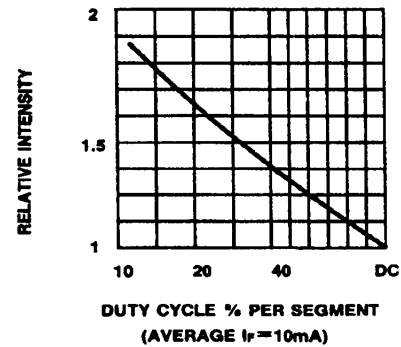

Fig.5 LUMINOUS INTENSITY VS. DUTY CYCLE

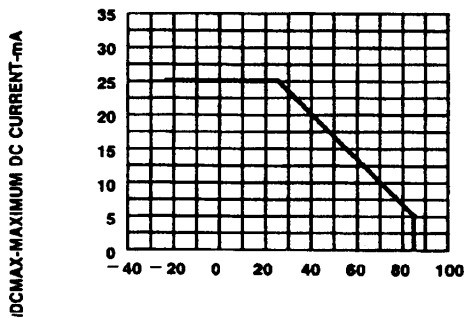

Fig.4 MAXIMUM ALLOWABLE DC CURRENT PER SEGMENT CS. A FUNCTION OF AMBIENT TEMPERATURE.

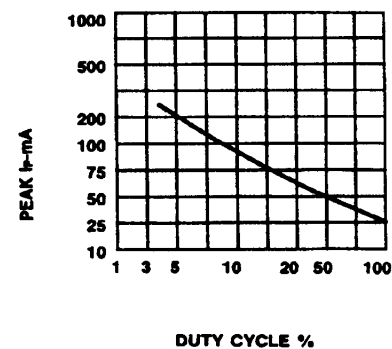

Fig.6 MAX PEAK CURRENT VS. DUTY CYCLE % (REFRESH RATE $f = 1 \text{ KHz}$)

GRAPHICAL DATA - High Efficiency Red ($T_A = 25^\circ\text{C}$ unless otherwise specified)

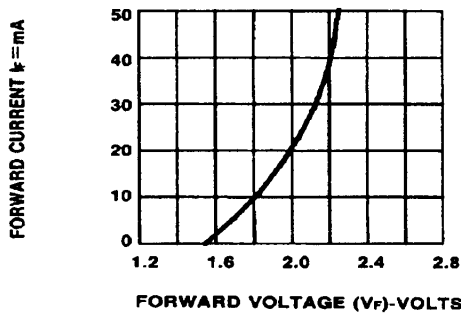

Fig. 1 FORWARD CURRENT VS. FORWARD VOLTAGE.

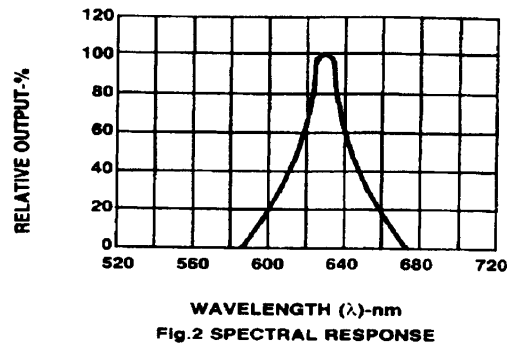

Fig. 2 SPECTRAL RESPONSE

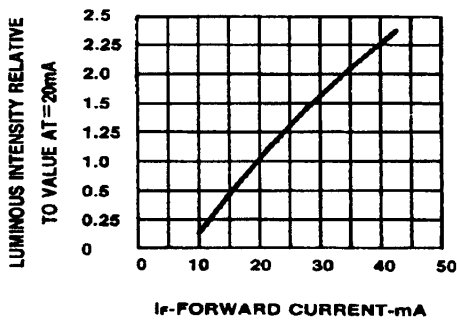

Fig. 3 RELATIVE LUMINOUS INTENSITY VS. FORWARD CURRENT

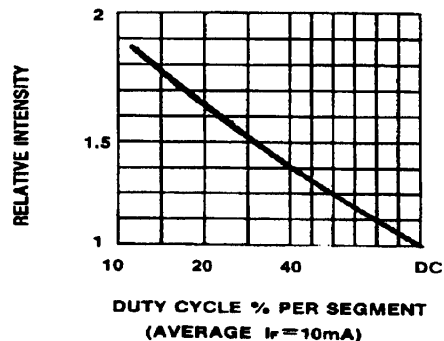

Fig. 5 LUMINOUS INTENSITY VS. DUTY CYCLE

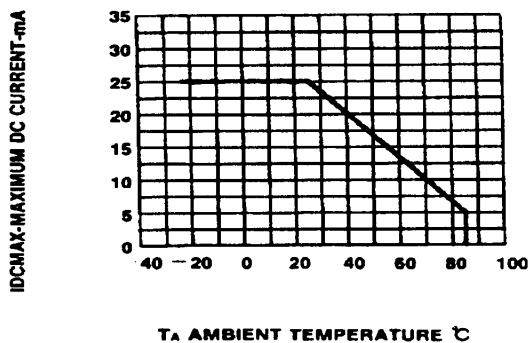

Fig. 4 MAXIMUM ALLOWABLE DC CURRENT PER SEGMENT VS. A FUNCTION OF AMBIENT TEMPERATURE.

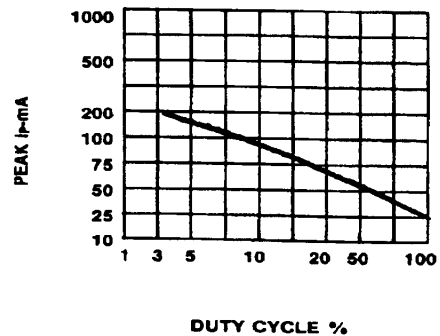

Fig. 6 MAX PEAK CURRENT VS. DUTY CYCLE % (REFRESH RATE $f = 1 \text{ KHz}$)

DISCLAIMER

FAIRCHILD SEMICONDUCTOR RESERVES THE RIGHT TO MAKE CHANGES WITHOUT FURTHER NOTICE TO ANY PRODUCTS HEREIN TO IMPROVE RELIABILITY, FUNCTION OR DESIGN. FAIRCHILD DOES NOT ASSUME ANY LIABILITY ARISING OUT OF THE APPLICATION OR USE OF ANY PRODUCT OR CIRCUIT DESCRIBED HEREIN; NEITHER DOES IT CONVEY ANY LICENSE UNDER ITS PATENT RIGHTS, NOR THE RIGHTS OF OTHERS.

LIFE SUPPORT POLICY

FAIRCHILD'S PRODUCTS ARE NOT AUTHORIZED FOR USE AS CRITICAL COMPONENTS IN LIFE SUPPORT DEVICES OR SYSTEMS WITHOUT THE EXPRESS WRITTEN APPROVAL OF THE PRESIDENT OF FAIRCHILD SEMICONDUCTOR CORPORATION. As used herein:

1. Life support devices or systems are devices or systems which, (a) are intended for surgical implant into the body, or (b) support or sustain life, and (c) whose failure to perform when properly used in accordance with instructions for use provided in the labeling, can be reasonably expected to result in a significant injury of the user.
2. A critical component in any component of a life support device or system whose failure to perform can be reasonably expected to cause the failure of the life support device or system, or to affect its safety or effectiveness.