

**Bright Red MANC3110, MANC3140
High Efficiency Red MANC3910, MANC3940
Green MANC3410, MANC3440**

TR/QTO/SV001

PACKAGE DIMENSIONS	FEATURES	
<p>Technical drawing showing package dimensions for the MANC3XX0 numeric frame display. Dimensions are provided in inches (mm) and include tolerances. Key dimensions include: top width 0.300 (7.62), top height 0.24 (6.10), segment height 0.200 (5.08), total height 0.390 (9.91), lead height 0.150 (3.81), lead width 0.020 (0.508), lead spacing 0.100 (2.54), bottom width 0.500 (12.70), and segment width 0.168 (4.27).</p>	<ul style="list-style-type: none"> •Bright Bold Segments •Common Anode/Cathode •Low Power Consumption •Low Current Capability •Neutral Segments •Grey Face •Epoxy Encapsulated Frame •High Performance •High Reliability 	
<p>NOTES:</p> <ul style="list-style-type: none"> •Dimensions are inches (mm) •Tolerances are +/- 0.010 (0.25mm) unless otherwise stated. 	<th style="background-color: #0056b3; color: white;">APPLICATIONS</th> <ul style="list-style-type: none"> •Appliances •Automotive •Instrumentation •Process Control 	APPLICATIONS

MODELS AVAILABLE			
Part Number	Colour	Description	Recommended I _F Levels
MANC3110	Bright Red	Common Anode	Standard Current (5mA - 20mA)
MANC3140	Bright Red	Common Cathode	Standard Current (5mA - 20mA)
MANC3410	Green	Common Anode	Standard Current (5mA - 20mA)
MANC3440	Green	Common Cathode	Standard Current (5mA - 20mA)
MANC3910	High Efficiency Red	Common Anode	Standard Current (5mA - 20mA)
MANC3940	High Efficiency Red	Common Cathode	Standard Current (5mA - 20mA)

(For other colour options, contact your local area Sales Manager)

ABSOLUTE MAXIMUM RATINGS⁽¹⁾ ($T_A = 25^\circ\text{C}$, unless otherwise specified)

Part Number	MANC3110	MANC3410	MANC3910	
Parameter	MANC3140	MANC3440	MANC3940	Units
Continuous Forward Current (each segment)	15	25	25	mA
Peak Forward Current ($F = 10\text{KHz}$, $D/F = 1/10$)	60	90	90	mA
Power Dissipation (P_D)	40	70	70	mW
*Derate Linearly from 25°C	0.17	0.33	0.33	mW
Reverse Voltage per Die	5 Volts			
Operating and Storage Temperature Range	-40°C to +85°C			
Lead soldering time (1/16 inch from standoffs)	5 seconds @ 230°C			

ELECTRO-OPTICAL CHARACTERISTICS⁽¹⁾ ($T_A = 25^\circ\text{C}$, unless otherwise specified)

Part Number	MANC3110	MANC3410	MANC3910		
Parameter	MANC3140	MANC3440	MANC3940	Units	Test Condition
Luminous intensity⁽²⁾ (I_V)					
Minimum (Standard Current)		860	980	ucd	$I_F = 5\text{mA}$
Typical (Standard Current)	700	6800	5390	ucd	$I_F = 20\text{mA}$
For low current versions see	MAN3H10	MAN3G10	MAN3R10		
	MAN3H40	MAN3G40	MAN3R40		
Forward Voltage (V_F)					
Typical (Standard Current)	2.10	2.10	2.00	Volts	$I_F = 20\text{mA}$
Maximum (Standard Current)	2.80	2.80	2.50	Volts	$I_F = 20\text{mA}$
Peak Wavelength	700	568	643	nm	$I_F = 20\text{mA}$
Dominant Wavelength		573	632	nm	$I_F = 20\text{mA}$
Spectral Line 1/2 Width	90	30	45	nm	$I_F = 10\text{mA}$
Reverse B⁽³⁾.Voltage (V_R)	5	5	5	Volts	$I_R = 100\mu\text{A}$

NOTES:

(1) Data per individual LED element

(2) Luminous intensity (ucd) = average light output per segment

(3) B = breakdown

PIN ORIENTATION, SEGMENT IDENTIFICATION, AND PRODUCT MARKING

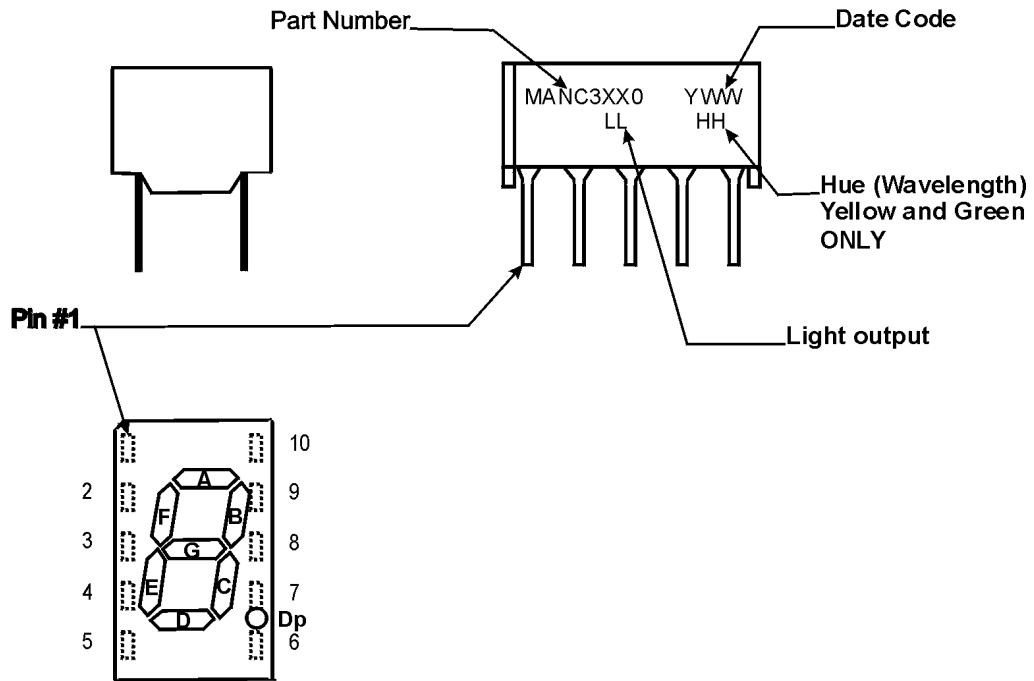

SCHEMATICS

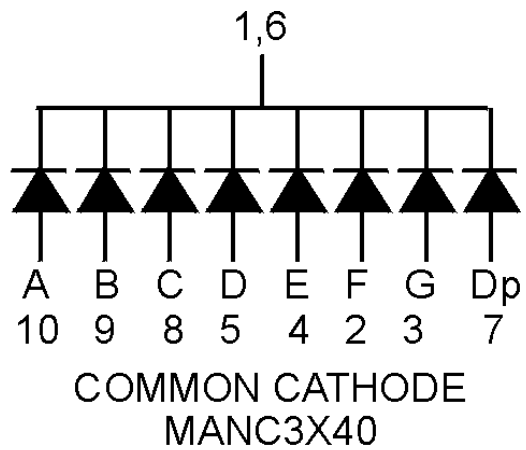
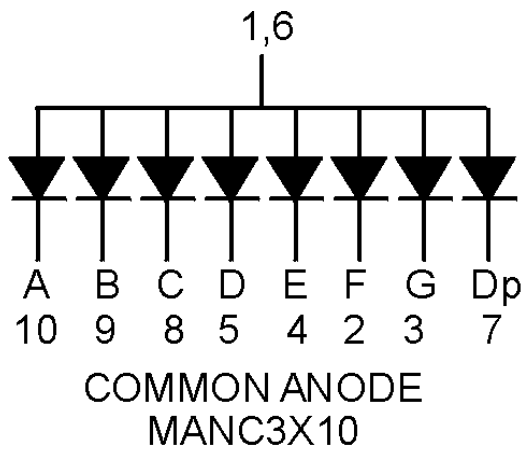

GRAPHICAL DATA Bright Red ($T_A = 25^\circ\text{C}$, unless otherwise specified)

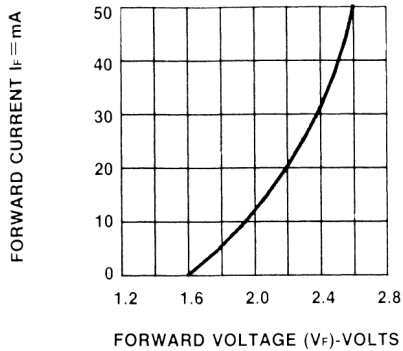

Fig.1 FORWARD CURRENT VS. FORWARD VOLTAGE.

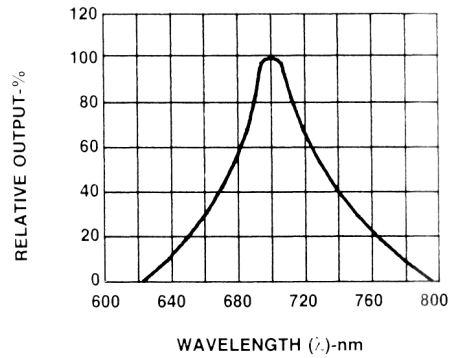

Fig.2 SPECTRAL RESPONSE

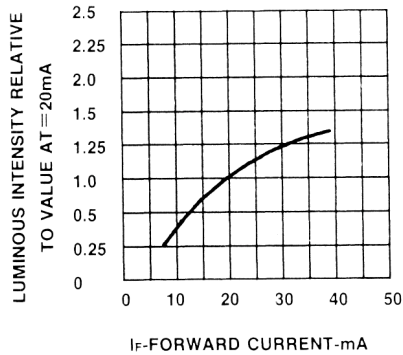

Fig.3 RELATIVE LUMINOUS INTENSITY VS. FORWARD CURRENT

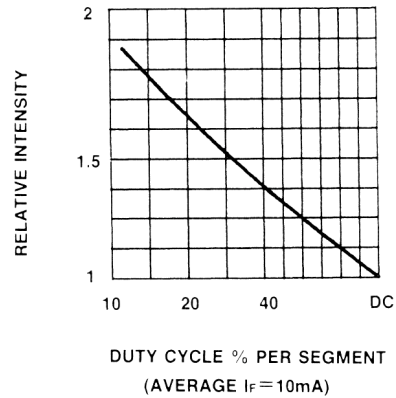

Fig.5 LUMINOUS INTENSITY VS. DUTY CYCLE

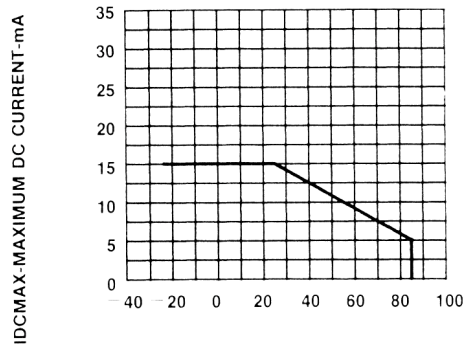

Fig.4 MAXIMUM ALLOWABLE DC CURRENT PER SEGMENT VS. A FUNCTION OF AMBIENT TEMPERATURE.

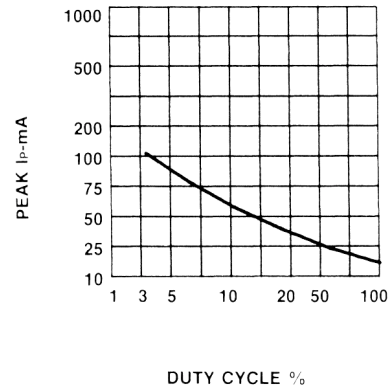

Fig. 6 MAX PEAK CURRENT VS. DUTY CYCLE % (REFRESH RATE $f = 1\text{ KHz}$)

GRAPHICAL DATA Green ($T_A = 25^\circ\text{C}$, unless otherwise specified)

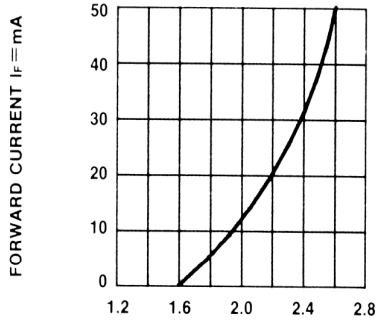

Fig.1 FORWARD CURRENT VS. FORWARD VOLTAGE.

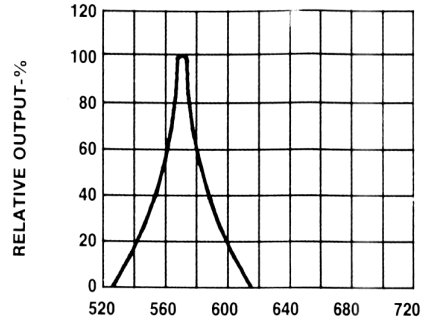

Fig.2 SPECTRAL RESPONSE

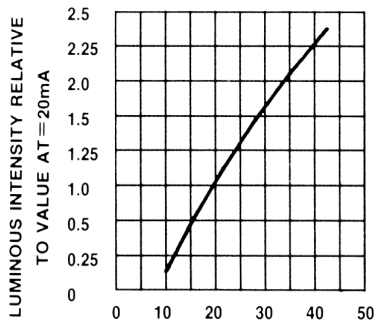

Fig.3 RELATIVE LUMINOUS INTENSITY VS. FORWARD CURRENT

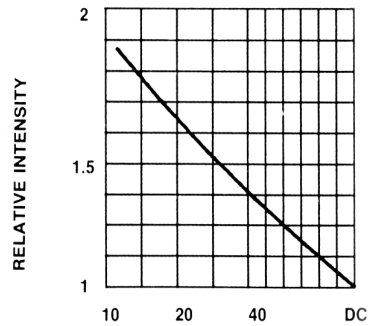

Fig.5 LUMINOUS INTENSITY VS. DUTY CYCLE

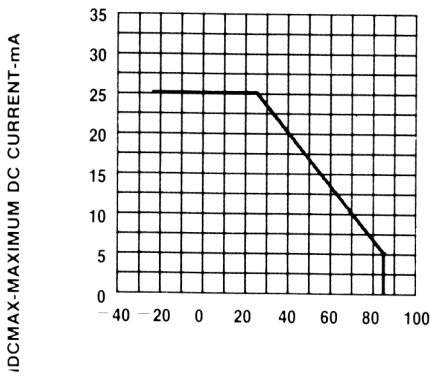

Fig.4 MAXIMUM ALLOWABLE DC CURRENT PER SEGMENT CS. A FUNCTION OF AMBIENT TEMPERATURE.

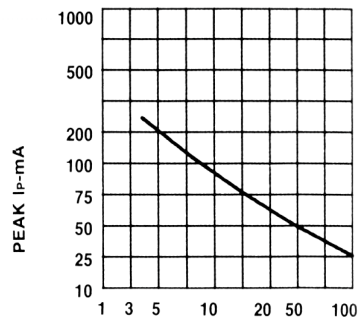

Fig. 6 MAX PEAK CURRENT VS. DUTY CYCLE % (REFRESH RATE $f = 1\text{ KHz}$)

GRAPHICAL DATA High Efficiency Red ($T_A = 25^\circ\text{C}$, unless otherwise specified)

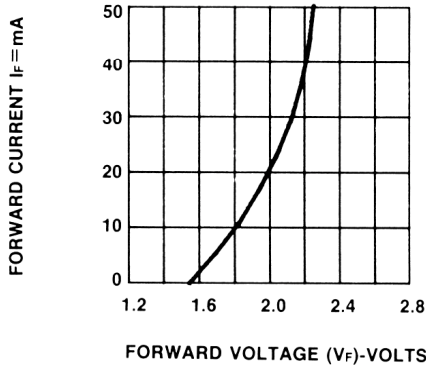

Fig.1 FORWARD CURRENT VS. FORWARD VOLTAGE.

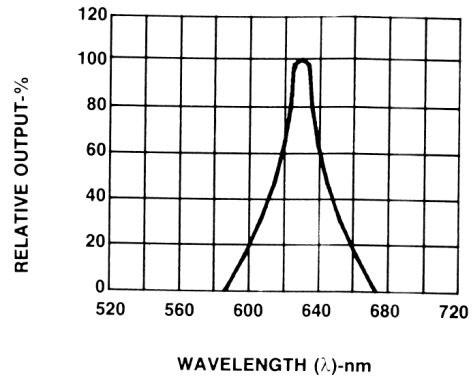

Fig.2 SPECTRAL RESPONSE

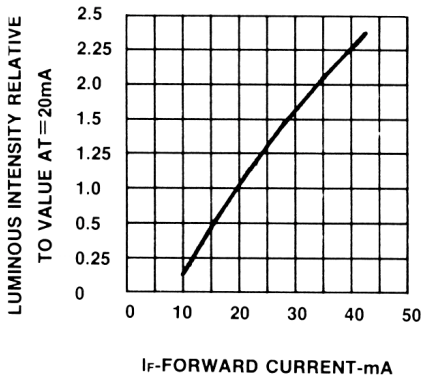

Fig.3 RELATIVE LUMINOUS INTENSITY VS. FORWARD CURRENT

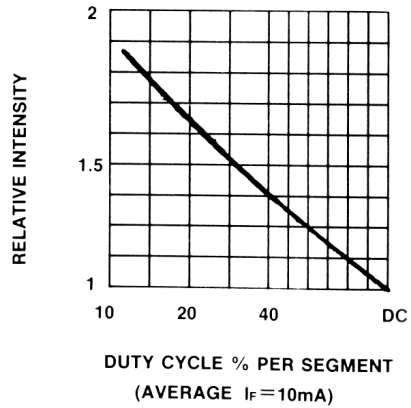

Fig.5 LUMINOUS INTENSITY VS. DUTY CYCLE

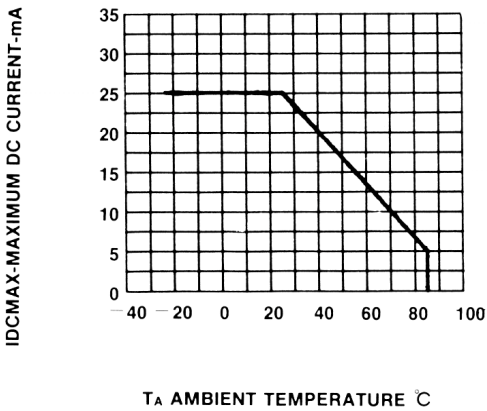

Fig.4 MAXIMUM ALLOWABLE DC CURRENT PER SEGMENT VS. A FUNCTION OF AMBIENT TEMPERATURE.

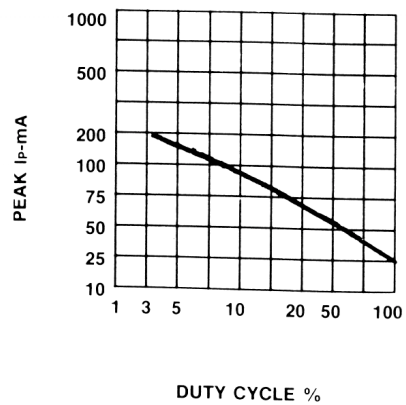

Fig. 6 MAX PEAK CURRENT VS. DUTY CYCLE % (REFRESH RATE $f = 1 \text{ KHz}$)

DISCLAIMER

FAIRCHILD SEMICONDUCTOR RESERVES THE RIGHT TO MAKE CHANGES WITHOUT FURTHER NOTICE TO ANY PRODUCTS HEREIN TO IMPROVE RELIABILITY, FUNCTION OR DESIGN. FAIRCHILD DOES NOT ASSUME ANY LIABILITY ARISING OUT OF THE APPLICATION OR USE OF ANY PRODUCT OR CIRCUIT DESCRIBED HEREIN; NEITHER DOES IT CONVEY ANY LICENSE UNDER ITS PATENT RIGHTS, NOR THE RIGHTS OF OTHERS.

LIFE SUPPORT POLICY

FAIRCHILD'S PRODUCTS ARE NOT AUTHORIZED FOR USE AS CRITICAL COMPONENTS IN LIFE SUPPORT DEVICES OR SYSTEMS WITHOUT THE EXPRESS WRITTEN APPROVAL OF THE PRESIDENT OF FAIRCHILD SEMICONDUCTOR CORPORATION. As used herein:

1. Life support devices or systems are devices or systems which, (a) are intended for surgical implant into the body, or (b) support or sustain life, and (c) whose failure to perform when properly used in accordance with instructions for use provided in the labeling, can be reasonably expected to result in a significant injury of the user.
2. A critical component in any component of a life support device or system whose failure to perform can be reasonably expected to cause the failure of the life support device or system, or to affect its safety or effectiveness.