

# HDSM-531B/533B

0.56inch (14.0mm)

Single digit surface mount LED display



## Data Sheet

### Description

This is 0.56 inch (14.0mm) height single digit display. This device utilizes InGaN/SiC blue LED chips. This device comes with gray top surface and white segments.

### Features

- 0.56" digit height
- Low current operation
- Excellent characters appearance
- Available in CA and CC
- 1000 pieces per reel
- Moisture Sensitivity Level: Level 3
- RoHS compliant

### Ordering Information

Blue	Description
HDSM-531B	Common Anode, Right Hand Decimal
HDSM-533B	Common Cathode, Right Hand Decimal

### Package Dimensions

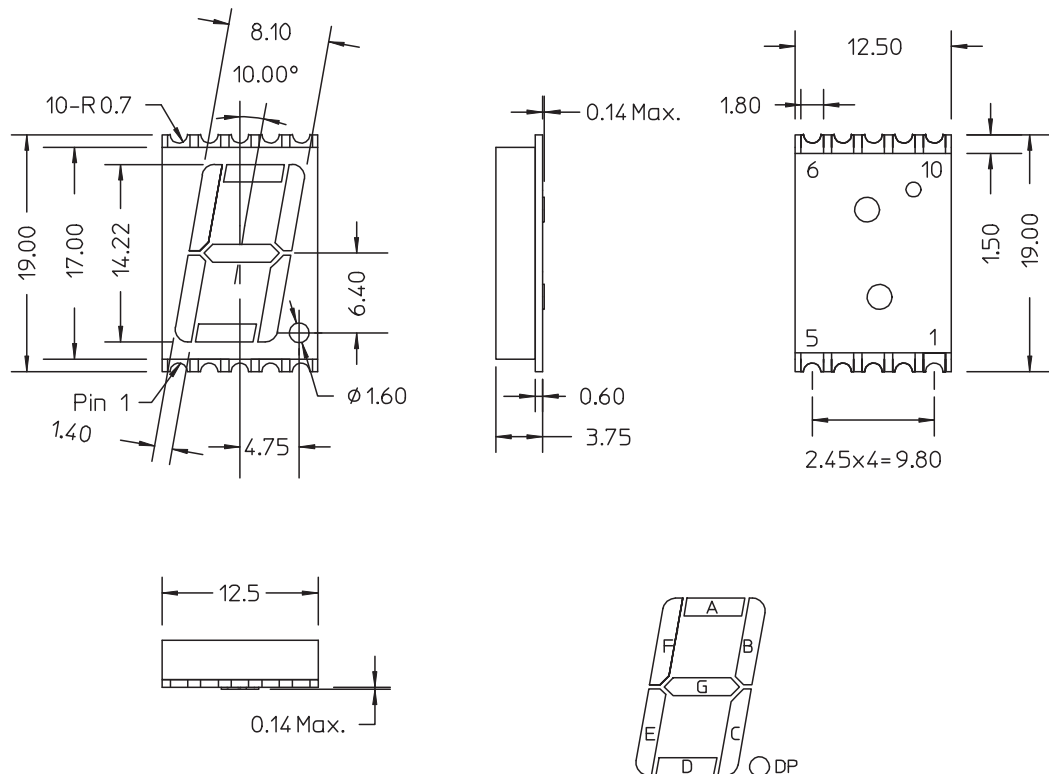

Notes:  
All dimensions are in millimeters (inches).  
Tolerance:  $\pm 0.25\text{mm}$  (0.01") unless otherwise noted.

**CAUTION:** LEDs are Class 1A ESD sensitive per JESD22-A114C.01.  
Please observe appropriate precautions during handling and processing.

### Pin Connection (Common Anode)

Pin No.	Connection
1	CATHODE E
2	CATHODE D
3	COMMON ANODE
4	CATHODE C
5	CATHODE DP
6	CATHODE B
7	CATHODE A
8	COMMON ANODE
9	CATHODE F
10	CATHODE G

### Pin Connection (Common Cathode)

Pin No.	Connection
1	ANODE E
2	ANODE D
3	COMMON CATHODE
4	ANODE C
5	ANODE DP
6	ANODE B
7	ANODE A
8	COMMON CATHODE
9	ANODE F
10	ANODE G

### Internal Circuit Diagram (Common Anode)

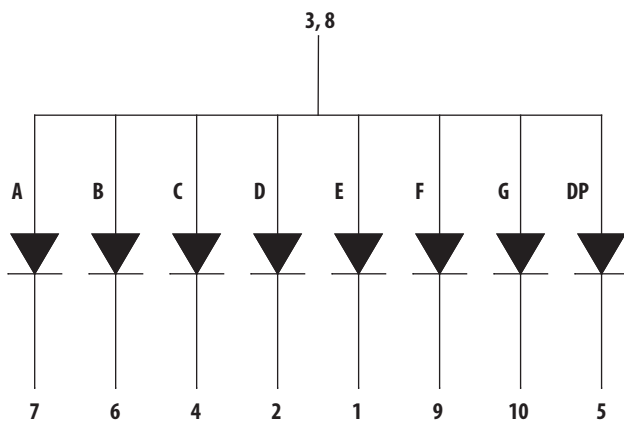

### Internal Circuit Diagram (Common Cathode)

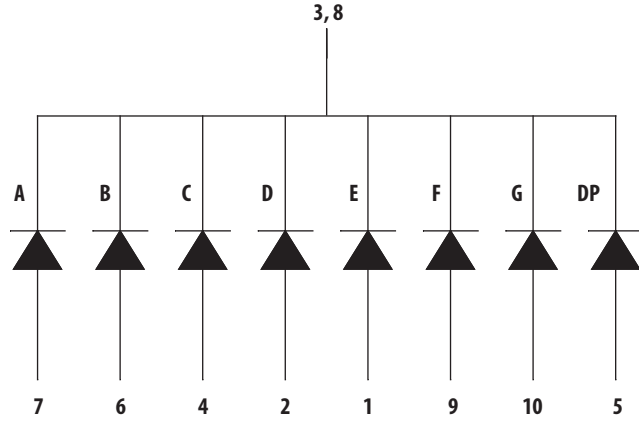

### Absolute Maximum Ratings @ $T_A=25^{\circ}\text{C}$

Parameter	Blue	Unit
Power Dissipation Per Segment	100	mW
Peak Forward Current Per Segment (1/10 Duty Cycle, 0.1ms pulse width)	80	mA
Continuous Forward Current Per Segment	25	mA
Derating Linearly From 25°C Per Segment	0.25	mA/°C
Reverse Voltage Per Segment	5	V
Operating Temperature Range		-40°C to+105°C
Storage Temperature Range		-40°C to+105°C

Caution in ESD: Static Electricity and surge damages the LED. It is recommend to use a wrist strap or anti-electrostatic glove when handling the LED. All devices, equipment and machinery must be properly grounded.

### Electrical / Optical Characteristics @ $T_A=25^{\circ}\text{C}$

#### Blue

Parameter	Symbol	Min.	Typ.	Max.	Unit	Test Condition
Average Luminous Intensity	$I_V$	5.4	13.5	–	mcd	$I_F = 10 \text{ mA}$
Emission Wavelength	$\lambda_p/\lambda_d$	–	462/470	–	nm	$I_F = 20 \text{ mA}$
Spectral Line Half-Width	$\Delta\lambda$	–	26	–	nm	$I_F = 20 \text{ mA}$
Forward Voltage, Per Segment	$V_F$	–	3.3	4.0	V	$I_F = 20 \text{ mA}$
Reverse Current, Per Segment	$I_R$	–	–	100	$\mu\text{A}$	$V_R = 5 \text{ V}$
Luminous Intensity Matching Ratio	$I_{V-m}$	–	–	2:1	–	$I_F = 10 \text{ mA}$

Typical Electrical / Optical characteristic Curves @  $T_A=25^\circ\text{C}$   
Blue

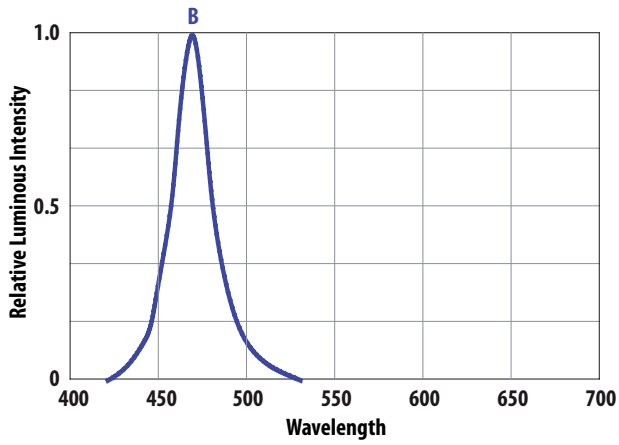

Figure 1. Relative Luminous Intensity vs. Wavelength

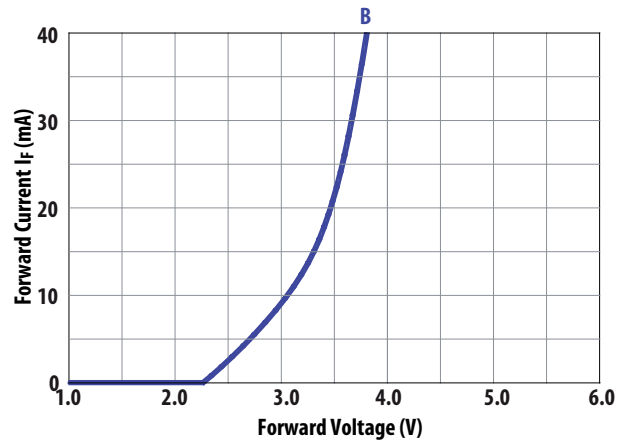

Figure 2. Forward Current vs. Forward Voltage

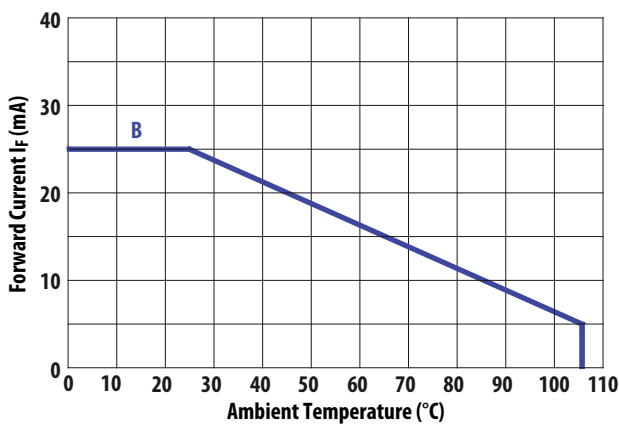

Figure 3. Allowable DC Current vs. Ambient Temperature

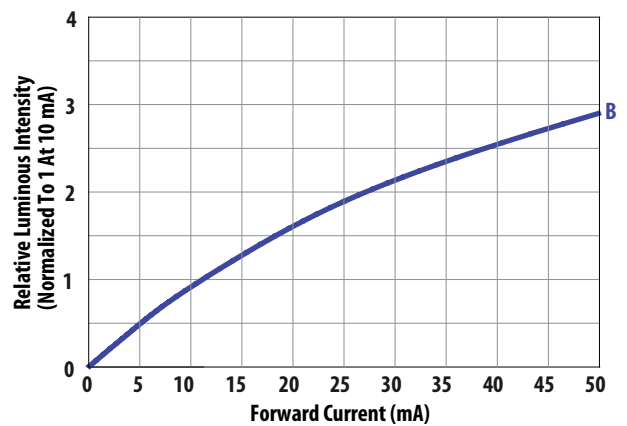

Figure 4. Relative Intensity vs. Forward Current

## Intensity Bin Limit (mcd)

### Blue

Iv Bin Category	Min	Max
M	5.401	8.600
N	8.601	13.700
P	13.701	21.800
Q	21.801	34.700

Tolerance +/-15%

Note:

1. Bin categories are established for classification of products. Products may not be available in all categories. Please contact your Avago representative for information on currently available bins.

## SMT Soldering Profile

### Pb free reflow soldering Profile

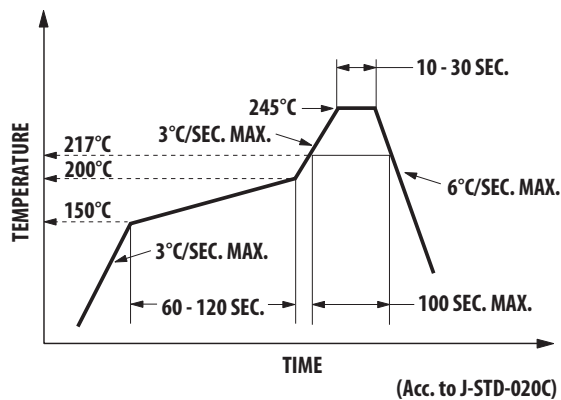

Notes:

1. The peak temperature refers to the peak package body temperature.
2. Number of reflow process shall be limited to maximum 2 times only. Cooling process to normal temperature is required between first and second soldering process.

## Recommended Soldering Pattern (unit: mm)

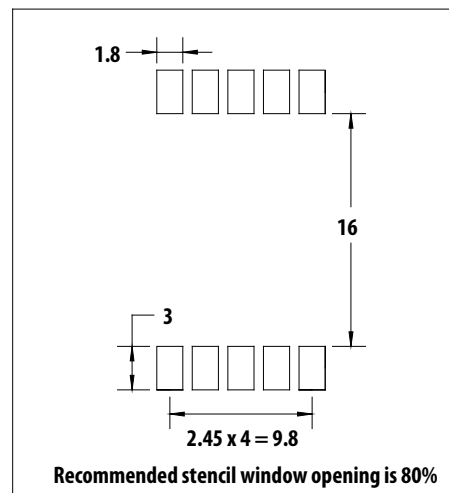

## Tape Specification (unit: mm)

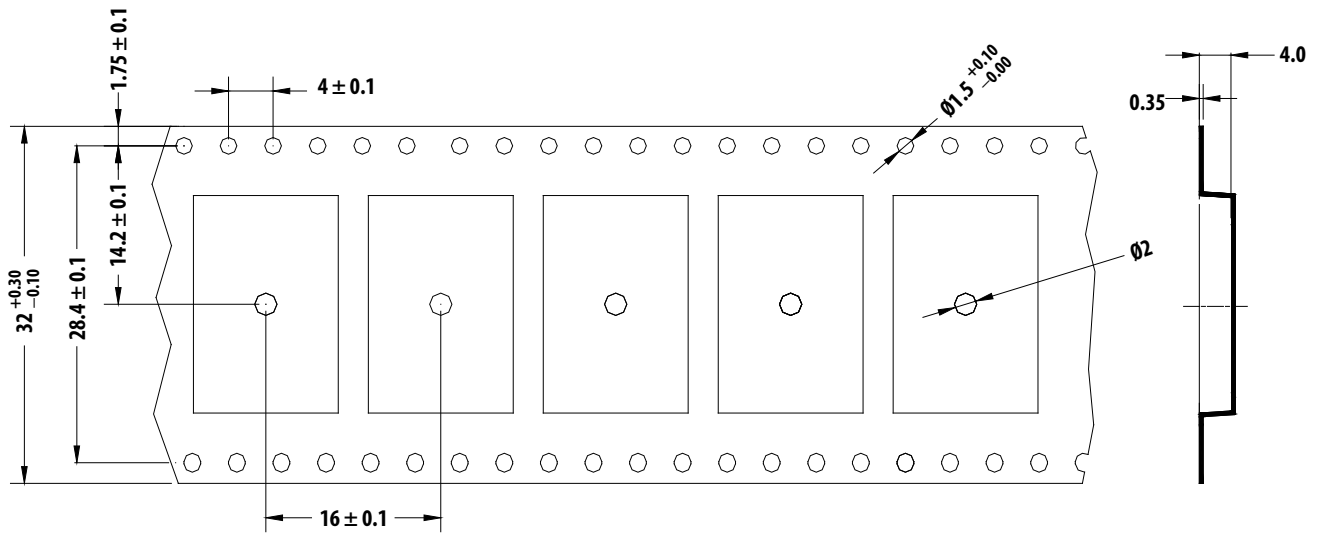

For product information and a complete list of distributors, please go to our web site: [www.avagotech.com](http://www.avagotech.com)

Avago, Avago Technologies, and the A logo are trademarks of Avago Technologies in the United States and other countries.  
Data subject to change. Copyright © 2005-2011 Avago Technologies. All rights reserved.  
AV02-1587EN - March 17, 2011

**AVAGO**  
TECHNOLOGIES