

HDSM-281B/283B

0.28inch (7.0mm)

Single digit surface mount LED display



Data Sheet

Description

This is 0.28 inch (7.0mm) height single digit display. This device utilizes InGaN/SiC blue LED chips. This device with top surface gray and white segments.

Ordering Information

Blue	Description
HDSM-281B	Common Anode, Upper and Lower Decimal
HDSM-283B	Common Cathode, Upper and Lower Decimal

Features

- 0.28" digit height
- Low current operation
- Excellent characters appearance
- Available in CA and CC
- 1000 pieces per reel
- Moisture Sensitivity Level: Level 3
- RoHS compliant

Package Dimensions

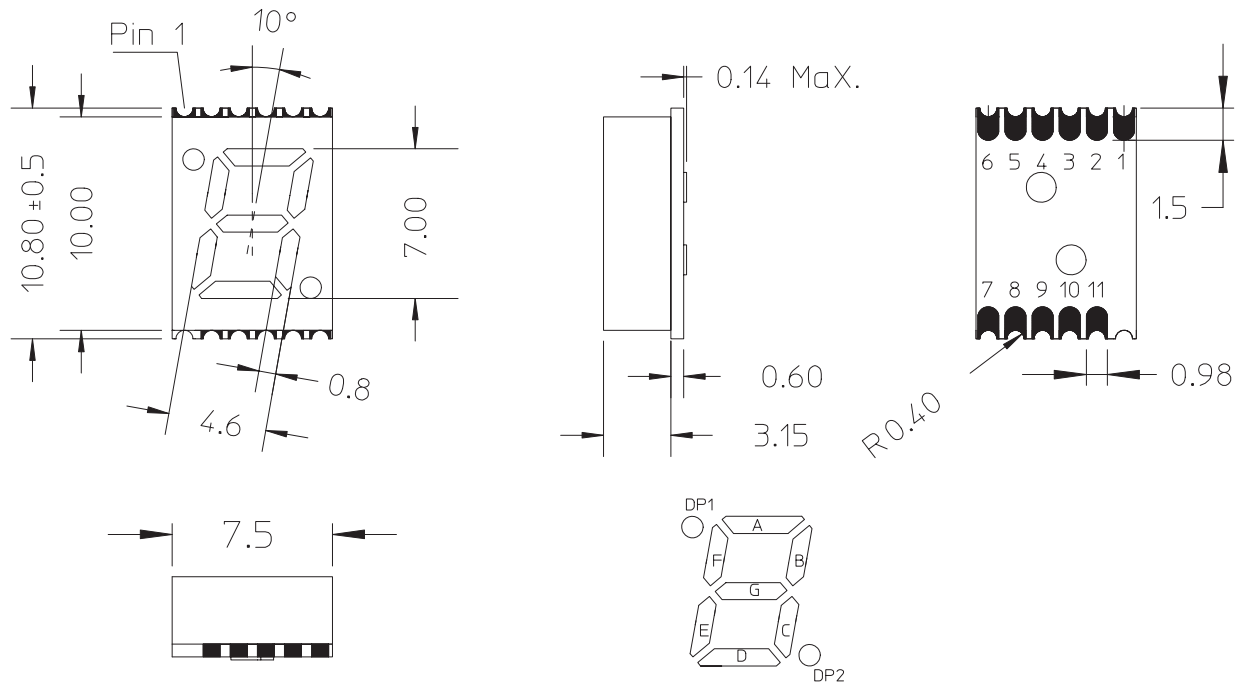

Notes:

All dimensions are in millimeters (inches).
Tolerance: $\pm 0.25\text{mm}$ (0.01") unless otherwise noted.

CAUTION: LEDs are Class 1A ESD sensitive per JESD22-A114C.01.
Please observe appropriate precautions during handling and processing.

Pin Connection (Common Anode)

Pin No.	Connection
1	CATHODE G
2	CATHODE DP1
3	CATHODE F
4	COMMON ANODE
5	CATHODE A
6	CATHODE B
7	CATHODE DP2
8	CATHODE C
9	COMMON ANODE
10	CATHODE D
11	CATHODE E

Pin Connection (Common Cathode)

Pin No.	Connection
1	ANODE G
2	ANODE DP1
3	ANODE F
4	COMMON CATHODE
5	ANODE A
6	ANODE B
7	ANODE DP2
8	ANODE C
9	COMMON CATHODE
10	ANODE D
11	ANODE E

Internal Circuit Diagram (Common Anode)

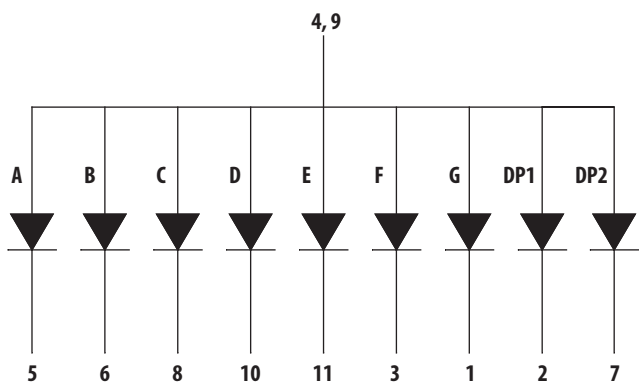

Internal Circuit Diagram (Common Cathode)

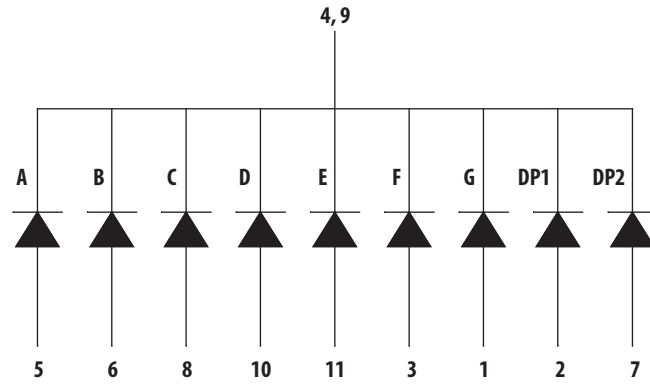

Absolute Maximum Ratings @ T_A=25°C

Parameter	Blue	Unit
Power Dissipation Per Segment	100	mW
Peak Forward Current Per Segment (1/10 Duty Cycle, 0.1ms pulse width)	80	mA
Continuous Forward Current Per Segment Derating Linearly From 25°C Per Segment	25 0.25	mA mA/°C
Reverse Voltage Per Segment	5	V
Operating Temperature Range	-40°C to +105°C	
Storage Temperature Range	-40°C to +105°C	

Caution in ESD: Static Electricity and surge damages the LED. It is recommended to use a wrist strap or anti-electrostatic glove when handling the LED. All devices, equipment and machinery must be properly grounded.

Electrical / Optical Characteristics @ T_A=25°C**Blue**

Parameter	Symbol	Min.	Typ.	Max.	Unit	Test Condition
Average Luminous Intensity	I _v	3.4	6	–	mcd	I _F = 10 mA
Emission Wavelength	λ _p /λ _d	–	462/470	–	nm	I _F = 20 mA
Spectral Line Half-Width	Δλ	–	26	–	nm	I _F = 20 mA
Forward Voltage, Per Segment	V _F	–	3.3	4.0	V	I _F = 20 mA
Reverse Current, Per Segment	I _R	–	–	100	μA	V _R = 5 V
Luminous Intensity Matching Ratio	I _{v-m}	–	–	2:1	–	I _F = 10 mA

Typical Electrical / Optical characteristic Curves @ $T_A=25^\circ\text{C}$
Blue

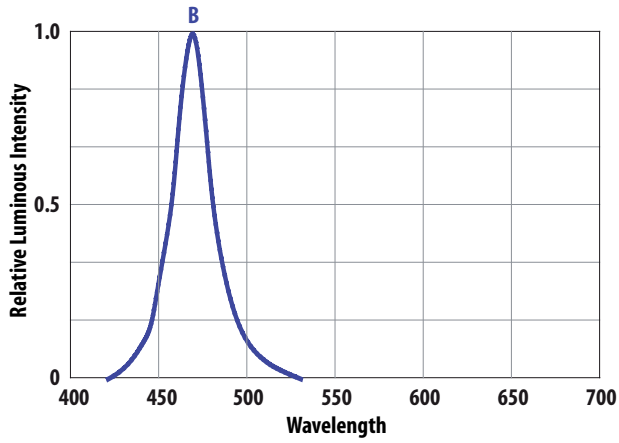

Figure 1. Relative luminous intensity vs. wavelength

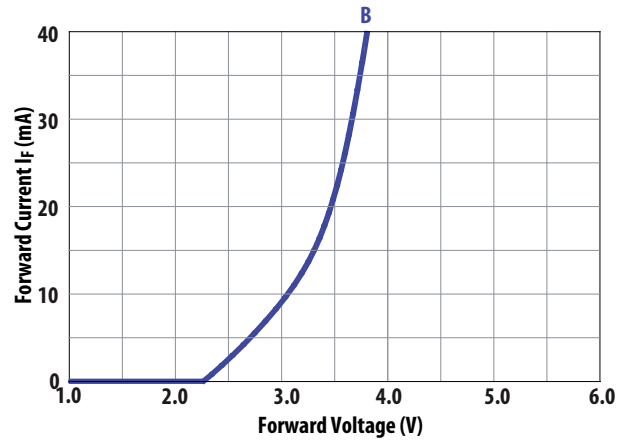

Figure 2. Forward current vs. forward voltage

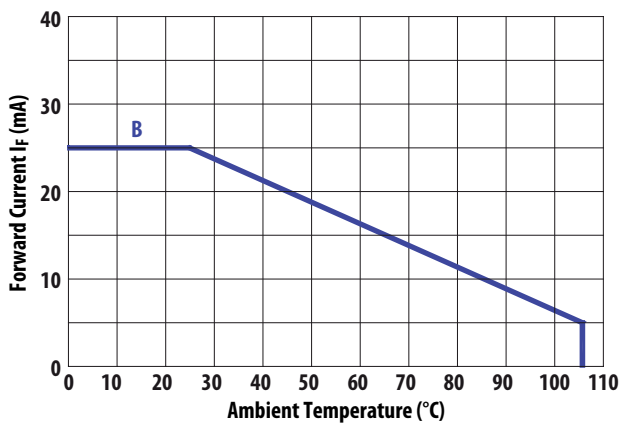

Figure 3. Allowable DC current vs. ambient temperature

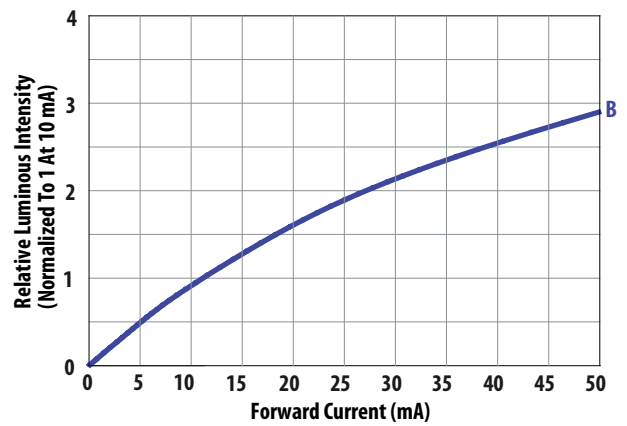

Figure 4. Relative intensity vs. forward current

Intensity Bin Limit (mcd)

Blue

Iv Bin Category	Min	Max
L	3.401	5.400
M	5.401	8.600
N	8.601	13.700

Tolerance +/-15%

Note:

1. Bin categories are established for classification of products. Products may not be available in all categories. Please contact your Avago representative for information on currently available bins.

SMT Soldering Profile

Pb free reflow soldering Profile

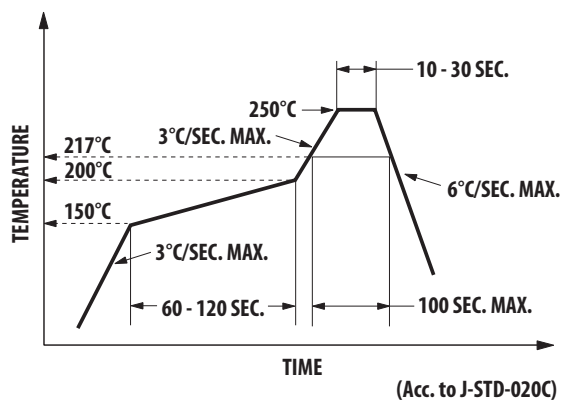

Notes:

1. The peak temperature refers to the peak package body temperature.
2. Number of reflow process shall be limited to maximum 2 times only. Cooling process to normal temperature is required between first and second soldering process.

Recommended soldering pattern (unit: mm)

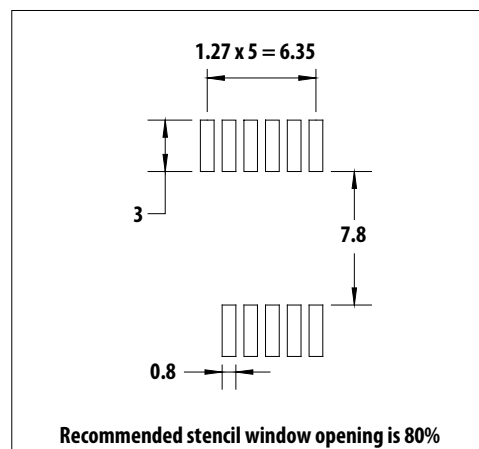

Tape Specification (unit: mm)

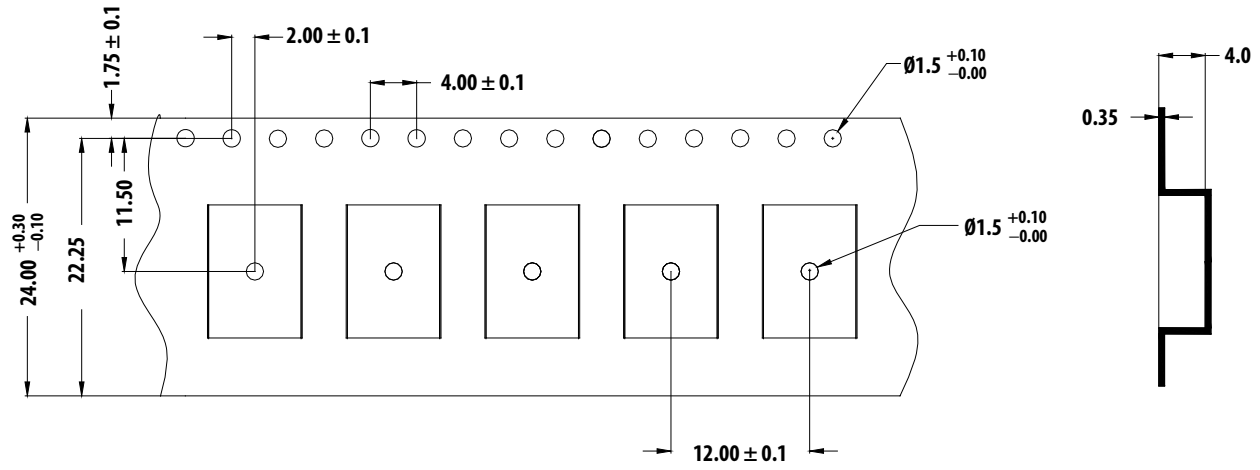

For product information and a complete list of distributors, please go to our web site: www.avagotech.com

Avago, Avago Technologies, and the A logo are trademarks of Avago Technologies in the United States and other countries.
Data subject to change. Copyright © 2005-2011 Avago Technologies. All rights reserved.
AV02-1645EN - March 17, 2011

AVAGO
TECHNOLOGIES