

# HDSP-B42G, HDSP-B47G

## 18:88 0.56" Four Digit Seven Segment Displays

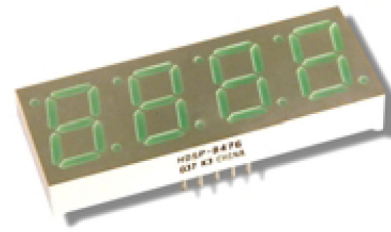

### Data Sheet



#### Description

The 18:88 0.56" Four Digit Seven Segment Displays incorporate a new slim font character design. This slim font features narrow width, specially mitered segments to give a fuller appearance to the illuminated character. Faces of these displays are painted a neutral gray for enhanced on/off contrast.

All devices are available in either common anode or common cathode configuration with tinted green segments.

#### Features

- Excellent appearance
- Slim font design
- Mitered corners, evenly illuminated segments
- Gray face for optimum on/off contrast
- Choice of colors: green
- Choice of character size: 0.56 inch
- Characterized for luminous intensity

#### Devices

Green	Description
HDSP-B42G	4 Digit, Common Anode, Tinted Green, 0.56" Display
HDSP-B47G	4 Digit, Common Cathode, Tinted Green, 0.56" Display

## Package Dimensions (HDSP-B42G/B47G)

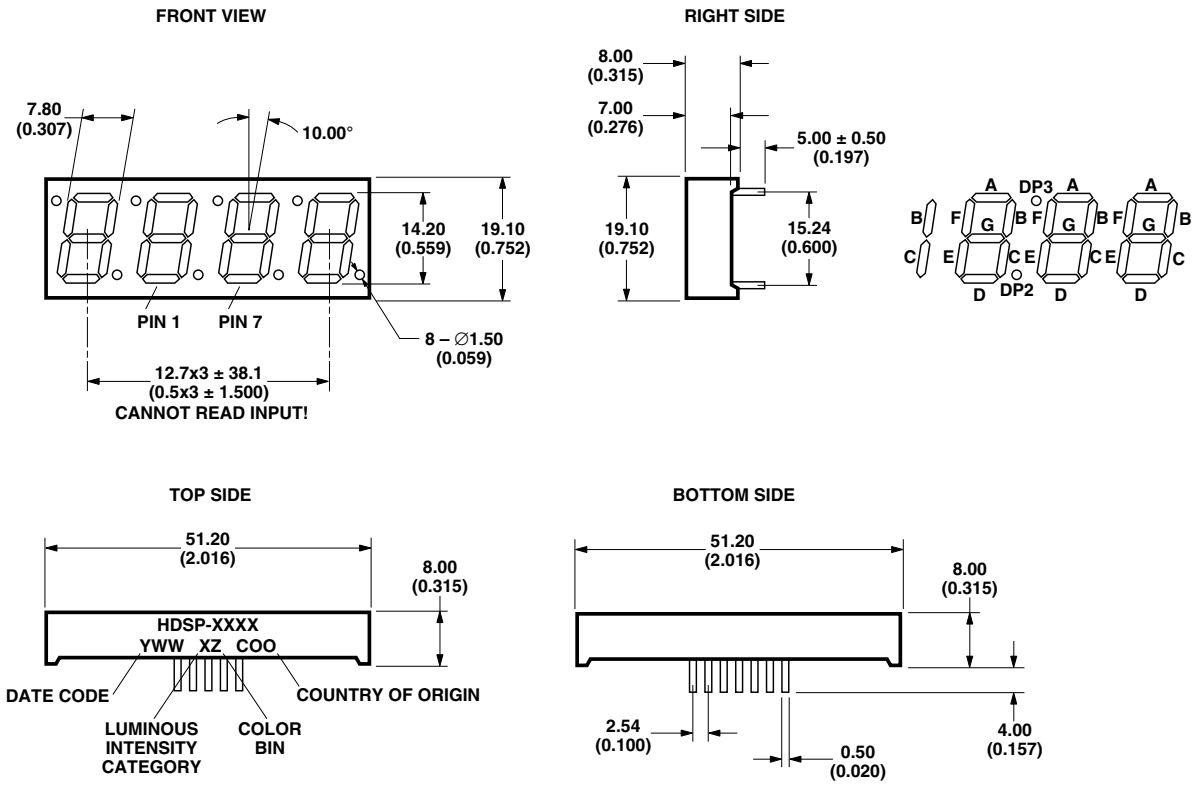

**NOTES:**

1. ALL DIMENSIONS ARE IN MILLIMETERS (INCHES).
2. UNLESS OTHERWISE STATED, TOLERANCES ARE ± 0.25 mm.

PIN	FUNCTION
1	E
2	D
3	DP
4	C
5	G
6	DIGIT 4 COMMON A/C
7	B
8	DIGIT 3 COMMON A/C
9	DIGIT 2 COMMON A/C
10	F
11	A
12	DIGIT 1 COMMON A/C

## Internal Circuit Diagram (Common Cathode)

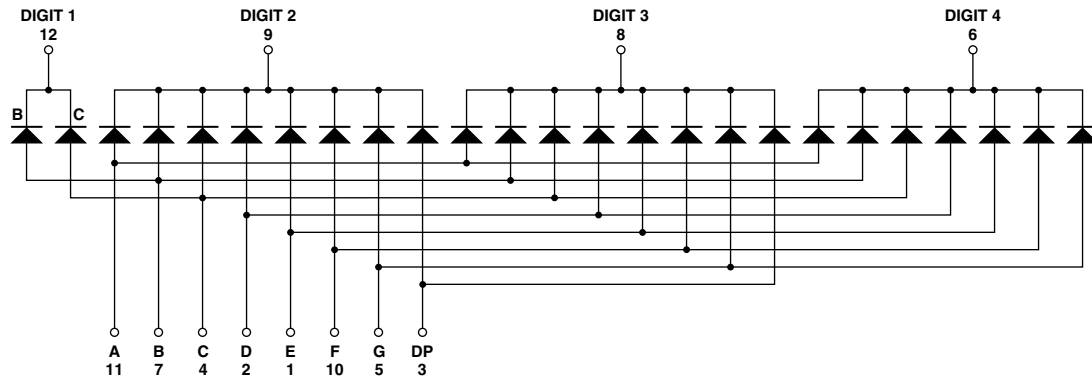

## Internal Circuit Diagram (Common Anode)

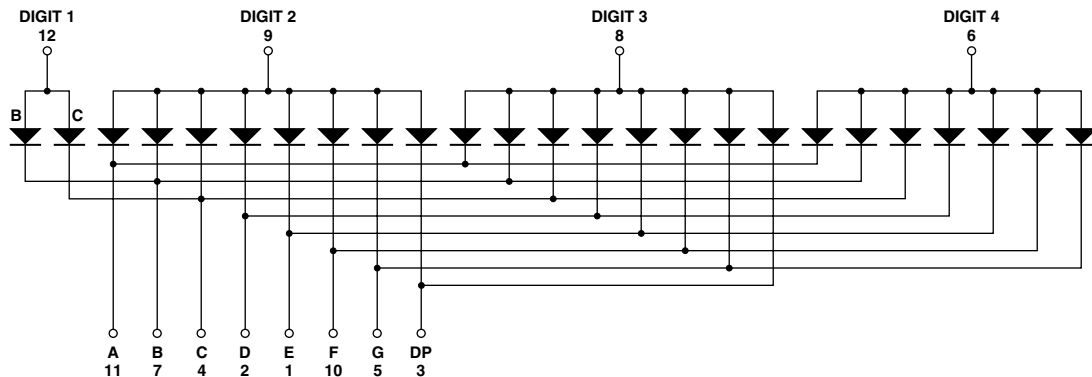

## Absolute Maximum Ratings

Description	Green	Units
Average Power per Segment or DP	65	mW
Peak Forward Current per Segment or DP	100	mA
DC Forward Current per Segment or DP	25	mA
Operating Temperature Range	-40 to +105	°C
Storage Temperature Range	-40 to +105	°C
Reverse Voltage per Segment or DP	3	V
Wavesoldering Temperature for 3 seconds 1.59 mm below body	250	°C

Note:

1. Derate above 40°C at 0.33 mA/°C for Green.

## Electrical/Optical Characteristics at TA = 25°C

Device Series	Parameter	Symbol	Min.	Typ.	Max.	Units	Test Conditions
HDSP-B42G/ HDSP-B47G	Luminous Intensity/ Segment (Digit Average)	$I_V$	2.000	3.200		mcd	$I_F = 10 \text{ mA}$
	Forward Voltage/ Segment or DP	$V_F$		2.20	2.50	V	$I_F = 20 \text{ mA}$
	Peak Wavelength	$\lambda_{PEAK}$		565		nm	$I_F = 20 \text{ mA}$
	Dominant Wavelength	$\lambda_d$		570		nm	$I_F = 20 \text{ mA}$
	Reverse Current	$I_R$			100	$\mu\text{A}$	$V_R = 5 \text{ V}$

Notes:

1. Typical specification for reference only. Do not exceed absolute maximum ratings.
2. The dominant wavelength,  $\lambda$ , is derived from the CIE chromaticity diagram and is that single wavelength which defines the color of the device.

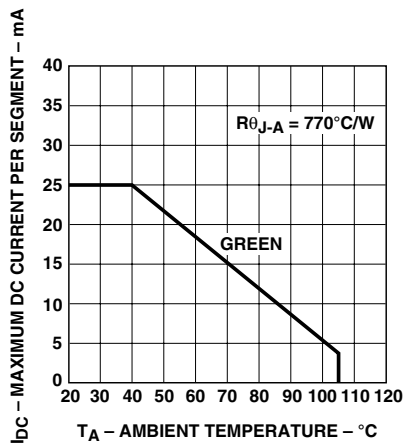

Figure 1. Maximum allowable DC current vs. ambient temperature.

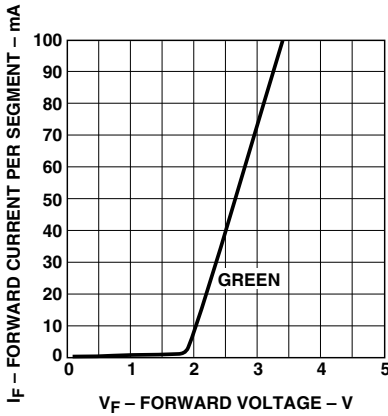

Figure 2. Forward current vs. forward voltage.

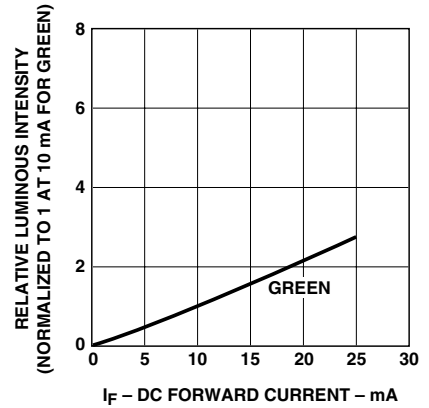

Figure 3. Relative luminous intensity vs. DC forward current.

## Contrast Enhancement

For information on contrast enhancement, please see Application Note 1015.

## Soldering/Cleaning

Cleaning agents from the ketone family (acetone, methyl ethyl ketone, etc.) and from the chlorinated hydrocarbon family (methylene chloride, trichloroethylene, carbon tetrachloride, etc.) are not recommended for cleaning LED parts. All of these various solvents attack or dissolve the encapsulating epoxies used to form the package of plastic LED parts.

For information on soldering LEDs, please refer to Application Note 1027.

For product information and a complete list of distributors, please go to our website: [www.avagotech.com](http://www.avagotech.com)

Avago, Avago Technologies, and the A logo are trademarks of Avago Technologies in the United States and other countries. Data subject to change. Copyright © 2005-2008 Avago Technologies. All rights reserved. Obsoletes 5988-4820EN AV02-1679EN - November 21, 2008

**AVAGO**  
TECHNOLOGIES