

ACPL-M61T

10MBd Wide Operating Temperature Automotive Digital Optocoupler with R²Coupler™ Isolation and AEC-Q100 Qualification



Data Sheet



Lead (Pb) Free
RoHS 6 fully compliant

RoHS 6 fully compliant options available;
-xxxE denotes a lead-free product

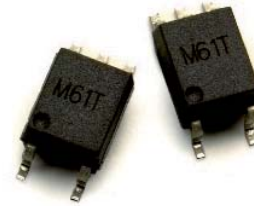

Description

This small outline wide operating temperature, high CMR, high speed, logic gate optocoupler is a single channel device in a five lead miniature footprint.

The ACPL-M61T optically coupled gates combine a AlGaAs light emitting diode and an integrated high gain photo detector. The output of the detector IC is an Open-collector Schottky-clamped transistor. The internal shield provides a guaranteed common mode transient immunity specification of 15,000 V/ μ s at $V_{CM}=1000V$.

This optocoupler is suitable for use in automotive high speed communications logic interfacing with low propagation delays, input/output buffering and is recommended for use in high operating temperature environment.

This unique design provides maximum AC and DC circuit isolation while achieving TTL compatibility. The optocoupler AC and DC operational parameters are guaranteed from -40°C to 125°C.

Avago R²Coupler isolation products provide the reinforced insulation and reliability needed for critical in automotive and high temperature industrial applications.

Functional Diagram

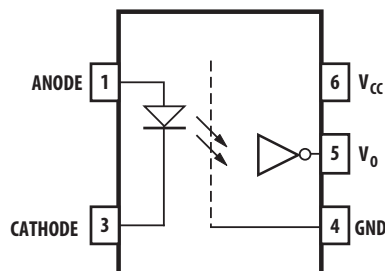

Features

- High Temperature and Reliability CANBus communication interface for Automotive Application.
- 15 kV/ μ s High Common-Mode Rejection at $V_{CM} = 1000 V$
- Compact, Auto-Insertable SO5 Packages
- Wide Temperature Range: -40°C ~ 125°C
- High Speed: 10MBd (Typical)
- Low LED Drive Current: 6.5mA (typ)
- Low Propagation Delay: 100ns (max)
- Worldwide Safety Approval:
 - UL 1577, 4000 Vrms/1 min.
 - CSA File CA88324, Notice #5
 - IEC/EN/DIN EN 60747-5-2 Approved
- Qualified to AEC-Q100 Test Guidelines

Applications

- Automotive CANBus Communications Interface
- High Temperature Digital Signal Isolation
- Micro-controller Interface
- Digital isolation for A/D, D/A conversion

CAUTION: It is advised that normal static precautions be taken in handling and assembly of this component to prevent damage and/or degradation which may be induced by ESD.

Ordering Information

Part Number	Option	Package	Surface Mount	Tape & Reel	IEC/EN/DIN EN 60747-5-2	Quantity
	(RoHS) Compliant					
ACPL-M61T	-000E	SO-5	X			100 per tube
	-060E		X		X	100 per tube
	-500E		X	X		1500 per reel
	-560E		X	X	X	1500 per reel

To order, choose a part number from the part number column and combine with the desired option from the option column to form an order entry.

Example 1:

ACPL-M61T-500E to order product of Mini-flat Surface Mount 5-pin package in Tape and Reel packaging with RoHS compliant.

Option datasheets are available. Contact your Avago sales representative or authorized distributor for information.

Schematic

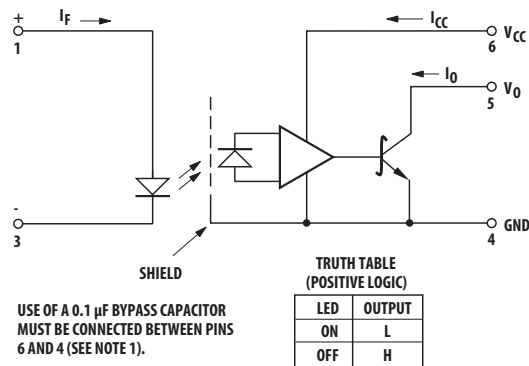

Land Pattern Recommendation

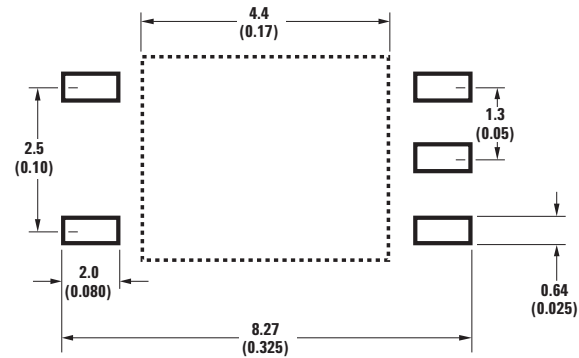

Package Outline Drawings

ACPL-M61T Small Outline SO-5 Package (JEDEC MO-155)

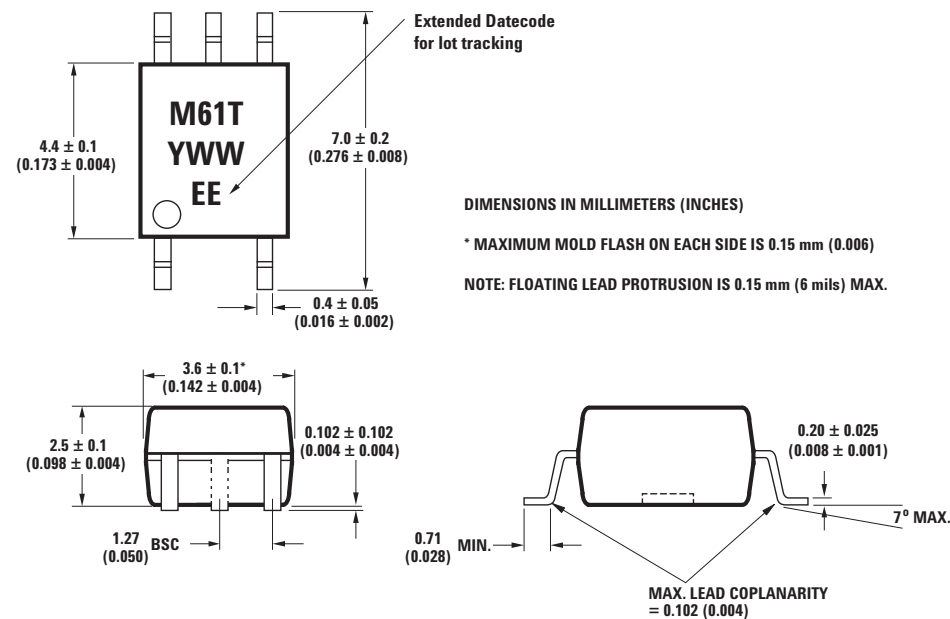

Recommended Pb-Free IR Profile

Recommended reflow condition as per JEDEC Standard, J-STD-020 (latest revision).

Note: Non-halide flux should be used.

Regulatory Information

The ACPL-M61T is approved by the following organizations:

UL

Approved under UL 1577, component recognition program up to $V_{ISO} = 4000 V_{RMS}$

CSA

Approved under CSA Component Acceptance Notice #5.

IEC/EN/DIN EN 60747-5-2

Approved under:
IEC 60747-5-2:1997 + A1
EN 60747-5-2:2001 + A1
DIN EN 60747-5-2 (VDE 0884 Teil 2)

IEC/EN/DIN EN 60747-5-2 Insulation Characteristics*

Description	Symbol	Characteristic	Unit
Installation classification per DIN VDE 0110/1.89, Table 1 for rated mains voltage $\leq 150 V_{RMS}$ for rated mains voltage $\leq 300 V_{RMS}$ for rated mains voltage $\leq 600 V_{RMS}$		I – IV I – III I – II	
Climatic Classification		55/125/21	
Pollution Degree (DIN VDE 0110/1.89)		2	
Maximum Working Insulation Voltage	V_{IORM}	567	V_{peak}
Input to Output Test Voltage, Method b* $V_{IORM} \times 1.875 = V_{PR}$, 100% Production Test with $t_m = 1$ sec, Partial discharge < 5 pC	V_{PR}	1063	V_{peak}
Input to Output Test Voltage, Method a* $V_{IORM} \times 1.6 = V_{PR}$, Type and Sample Test, $t_m = 10$ sec, Partial discharge < 5 pC	V_{PR}	907	V_{peak}
Highest Allowable Overvoltage (Transient Overvoltage $t_{ini} = 60$ sec)	V_{IOTM}	6000	V_{peak}
Safety-limiting values – maximum values allowed in the event of a failure.			
Case Temperature	T_S	175	$^{\circ}C$
Input Current	$I_{S, INPUT}$	230	mA
Output Power	$P_{S, OUTPUT}$	600	mW
Insulation Resistance at T_S , $V_{IO} = 500$ V	R_S	$> 10^9$	Ω

* Refer to the optocoupler section of the Isolation and Control Components Designer's Catalog, under Product Safety Regulations section, (IEC/EN/DIN EN 60747-5-2) for a detailed description of Method a and Method b partial discharge test profiles.

Insulation and Safety Related Specifications

Parameter	Symbol	ACPL-M61T	Units	Conditions
Minimum External Air Gap (Clearance)	L(101)	≥ 5	mm	Measured from input terminals to output terminals, shortest distance through air.
Minimum External Tracking (Creepage)	L(102)	≥ 5	mm	Measured from input terminals to output terminals, shortest distance path along body.
Minimum Internal Plastic Gap (Internal Clearance)		0.08	mm	Through insulation distance conductor to conductor, usually the straight line distance thickness between the emitter and detector.
Tracking Resistance (Comparative Tracking Index)	CTI	175	V	DIN IEC 112/VDE 0303 Part 1
Isolation Group (DIN VDE0109)		IIIa		Material Group (DIN VDE 0109)

Absolute Maximum Ratings

Parameter	Symbol	Min.	Max.	Units	Note
Storage Temperature	T _S	-55	125	°C	
Operating Temperature	T _A	-40	125	°C	
Lead Soldering Cycle	Temperature		260	°C	
	Time		10	sec	
Input Current (50% duty cycle, 1ms pulse width) (≤ 1us pulse width, 300ps)	Average	I _{F(avg)}	20	mA	12
	Peak	I _{F(peak)}	40	mA	
	Transient	I _{F(trans)}	100	mA	
Reversed Input Voltage	V _R		5	V	
Input Power Dissipation	P _I		30	mW	13
Output Power Dissipation	P _O		85	mW	14
Output Collector Current	I _O		50	mA	
Supply Voltage (Pins 6-4)	V _{CC}	-0.5	7	V	
Output Voltage (Pins 5-4)	V _O	-0.5	7	V	

Recommended Operating Conditions

Parameter	Symbol	Min.	Max.	Units
Supply Voltage	V _{CC}	4.5	5.5	V
Operating Temperature	T _A	-40	125	°C
Input Current, Low Level	I _{FL} *	0	250	μA
Input Current, High Level	I _{FH}	5	15	mA
Fan Out (RL = 1kΩ)	N		5	TTL Loads
Output Pull-Up Resistor	R _L	330	4,000	Ω

* The off condition can also be guaranteed by ensuring that V_{F(off)} ≤ 0.8Volts

Electrical Specifications (DC)

Over recommended operating Temperature T_A = -40°C to 125°C, unless otherwise specified.

Parameter	Symbol	Min.	Typ.*	Max.	Units	Conditions	Fig.	Note
Input Threshold Current	I _{TH}		2	5	mA	V _{CC} = 5.5V, I _O ≥ 13mA, V _O = 0.6V	4	
High Level Output Current	I _{OH}		5.5	100	μA	V _{CC} = 5.5V, V _O = 5.5V, V _F = 0.5V	1	
Low Level Output Voltage	V _{OL}		0.4	0.6	V	V _{CC} = 5.5V, I _F = 6.5mA, I _{OL} (Sinking) = 13mA	2, 4, 5	
High Level Supply Current	I _{CCH}		7.0	10.0	mA	V _{CC} = 5.5V, I _F = 0mA		
Low Level Supply Current	I _{CCL}		9.0	13.0	mA	V _{CC} = 5.5V, I _F = 10mA,		
Input Forward Voltage	V _F	1.45	1.5	1.75	V	T _A = 25°C, I _F = 10mA		
		1.25	1.5	1.85	V	I _F = 10mA		
Input Reversed Breakdown Voltage	BV _R	5			V	I _R = 10μA		
Temperature Coefficient of Forward Voltage	ΔV _F /ΔT _A		-1.5		mV/°C	I _F = 10mA	3, 12	

*All Typical at T_A = 25°C, V_{CC} = 5V.

Package Characteristics

Parameter	Symbol	Min.	Typ.	Max.	Units	Test Conditions	Fig.	Note
Input-Output Momentary Withstand Voltage*	V_{ISO}	4000			V_{RMS}	$RH \leq 50\%$, $t = 1 \text{ min}$; $T_A = 25^\circ\text{C}$		
Input-Output Resistance	R_{I-O}		10^{14}		Ω	$V_{I-O} = 500 \text{ Vdc}$		
Input-Output Capacitance	C_{I-O}		0.6		pF	$f = 1 \text{ MHz}$; $V_{I-O} = 0 \text{ Vdc}$		

* The Input-Output Momentary Withstand Voltage is a dielectric voltage rating that should not be interpreted as an input-output continuous voltage rating. For the continuous voltage rating refer to the IEC/EN/DIN EN 60747-5-2 Insulation Characteristics Table (if applicable), your equipment level safety specification, or Avago Technologies Application Note 1074, "Optocoupler Input-Output Endurance Voltage."

Switching Specifications (AC)

Over recommended temperature $T_A = -40^\circ\text{C}$ to 125°C , $V_{CC} = 5.0 \text{ V}$, $I_F = 6.5 \text{ mA}$ unless Otherwise Specified.

Parameter	Symbol	Min.	Typ.	Max.	Units	Test Conditions	Fig.	Note
Propagation Delay Time to Low Output Level	t_{PHL}		46	75	ns	$T_A = 25^\circ\text{C}$	6, 7, 8	6
				100	ns	$R_L = 350\Omega$ $C_L = 15\text{pF}$ $I_F = 6.5\text{mA}$		
Propagation Delay Time to High Output Level	t_{PLH}		50	75	ns	$T_A = 25^\circ\text{C}$	6, 7, 8	5
				100	ns			
Propagation Delay Skew	t_{PSK}			40	ns		14, 15	10, 11
Pulse Width Distortion	$ t_{PHL} - t_{PLH} $		3.5	35	ns		9	10
Output Rise Time (10% - 90%)	t_{rise}		24		ns		10	
Output Fall Time (10% - 90%)	t_{fall}		10		ns		10	
Common Mode Transient Immunity at High Output Level	$ CM_H $	15	30		$\text{kV}/\mu\text{s}$	$V_{CM} = 1000\text{Vp-p}$ $V_o(\text{min}) = 2\text{V}$ $I_F = 0\text{mA}$ $T_A = 25^\circ\text{C}$ $R_L = 350\Omega$	11	7,9
Common Mode Transient Immunity at Low Output Level	$ CM_L $	15	30		$\text{kV}/\mu\text{s}$	$V_{CM} = 1000\text{Vp-p}$ $V_o(\text{max}) = 0.8\text{V}$ $I_F = 6.5\text{mA}$ $T_A = 25^\circ\text{C}$ $R_L = 350\Omega$		8,9

*All Typical at $T_A = 25^\circ\text{C}$, $V_{CC} = 5\text{V}$.

Notes:

- By-passing of the power supply line is required with a 0.1 μF ceramic disc capacitor adjacent to each optocoupler. The total lead length between both ends of the capacitor and the isolator pins should not exceed 10 mm.
- Peaking circuits may produce transient input currents up to 40 mA, 50 ns maximum pulse width, provided average current does not exceed 20 mA.
- Device considered a two terminal device: pins 1 and 3 shorted together and pins 4, 5 and 6 shorted together.
- In accordance with UL 1577, each optocoupler is proof tested by applying an insulation test voltage $\geq 4800 V_{RMS}$ for 1 second.
- The t_{PLH} propagation delay is measured from 3.25 mA point on the falling edge of the input pulse to the 1.5 V point on the rising edge of the output pulse.
- The t_{PHL} propagation delay is measured from 3.25 mA point on the rising edge of the input pulse to the 1.5 V point on the falling edge of the output pulse.
- CM_H is the maximum tolerable rate of rise of the common mode voltage to assure that the output will remain in a high logic state (i.e., $V_{OUT} > 2.0\text{V}$).
- CM_L is the maximum tolerable rate of fall of the common mode voltage to assure that the output will remain in a low logic state (i.e., $V_{OUT} < 0.8\text{V}$).
- For sinusoidal voltages, $(|dV_{CM}|/dt)_{\text{max}} = \pi f_{CM} V_{CM(p-p)}$.
- See application section; "Propagation Delay, Pulse-Width Distortion and Propagation Delay Skew" for more information.
- t_{PSK} is equal to the worst case difference in t_{PHL} and/or t_{PLH} that will be seen between units at any given temperature within the worst case operating condition range.
- Input current derates linearly above 85°C free-air temperature at a rate of $0.25 \text{ mA}/^\circ\text{C}$.
- Input power derates linearly above 85°C free-air temperature at a rate of $0.375 \text{ mW}/^\circ\text{C}$.
- Output power derates linearly above 85°C free-air temperature at a rate of $0.475 \text{ mW}/^\circ\text{C}$.

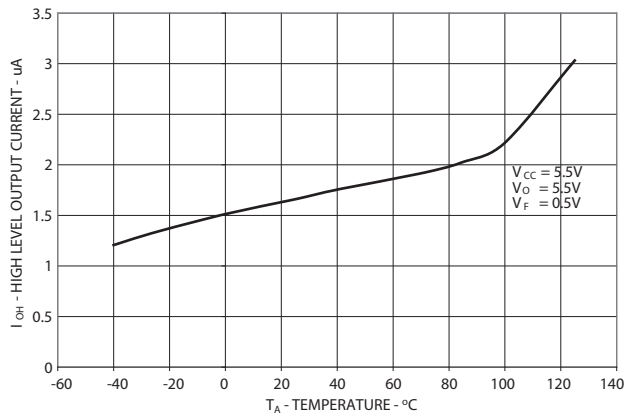

Figure 1. High Level Output Current vs Temperature

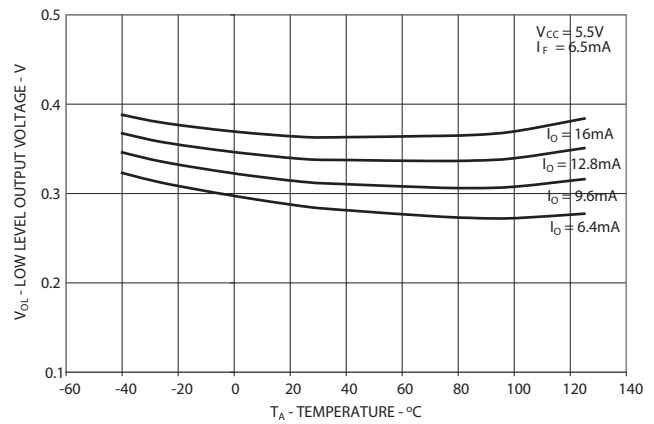

Figure 2. Low Level Output Voltage vs. Temperature

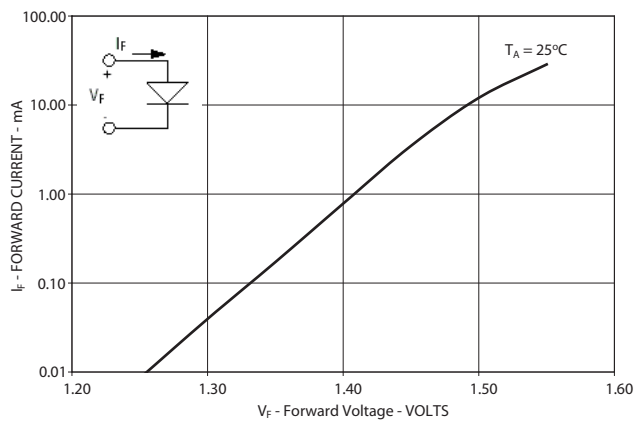

Figure 3. Input Current vs Forward Voltage

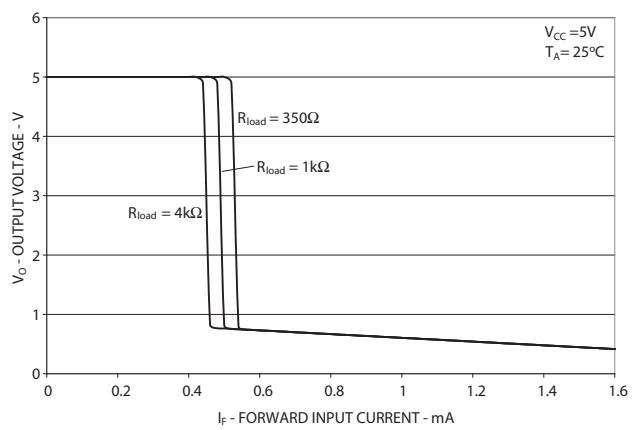

Figure 4. Output Voltage vs Forward Input current

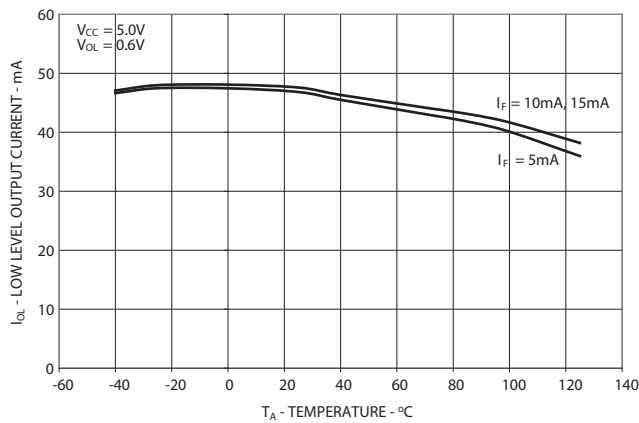

Figure 5. Low Level Output Current vs. Temperature

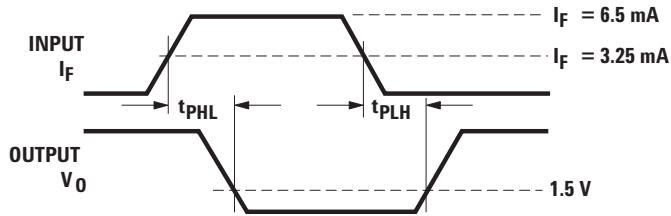
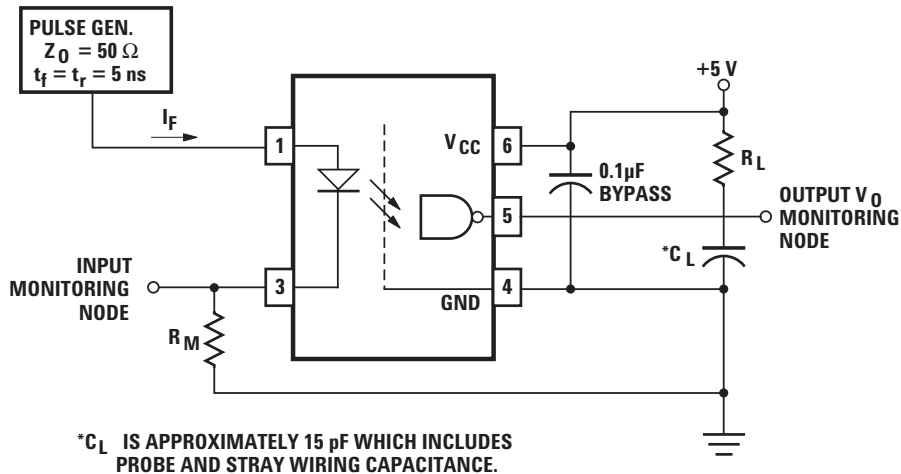

Figure 6. Test Circuit for t_{PHL} and t_{PLH}

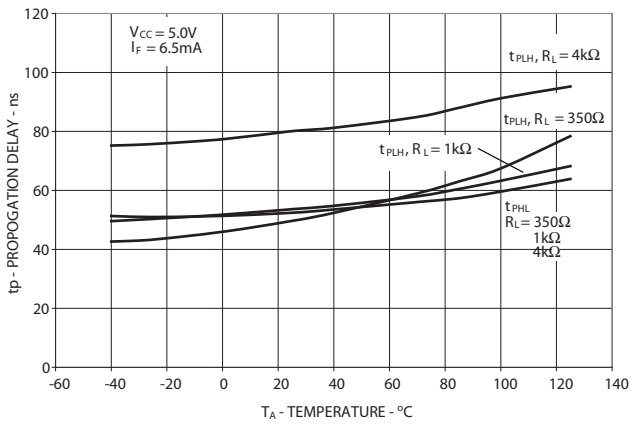

Figure 7. Propagation Delay vs. Temperature

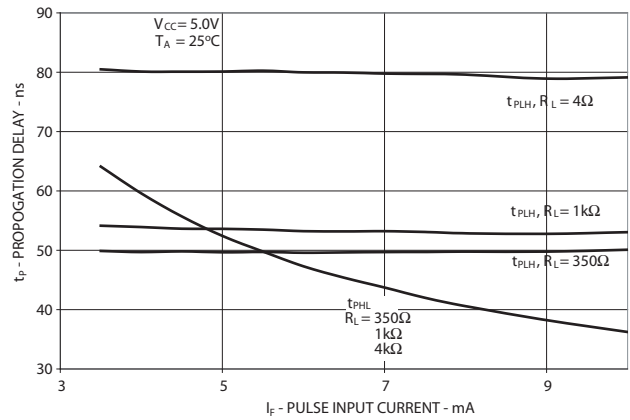

Figure 8. Propagation Delay vs. Pulse Input Current

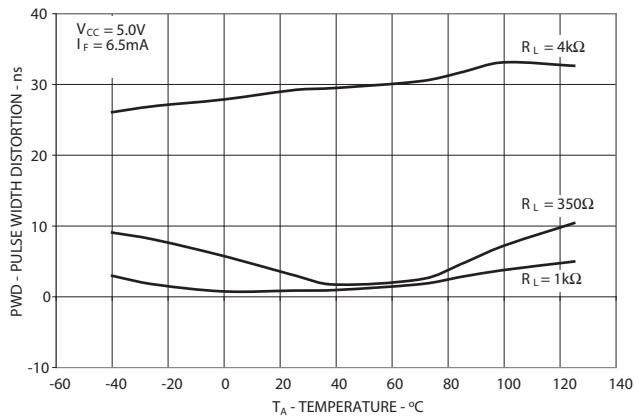

Figure 9. Pulse Width Distortion vs Temperature

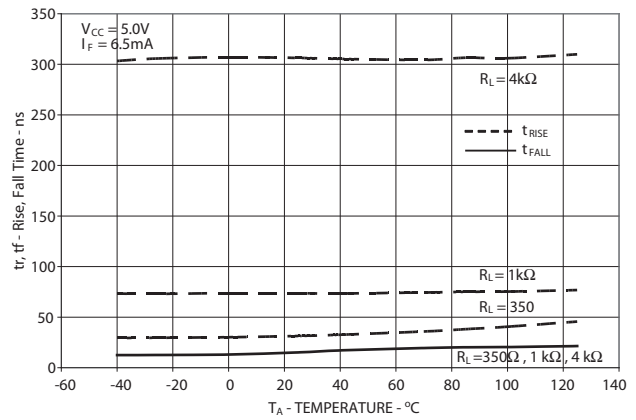

Figure 10. Rise and Fall Time vs Temperature

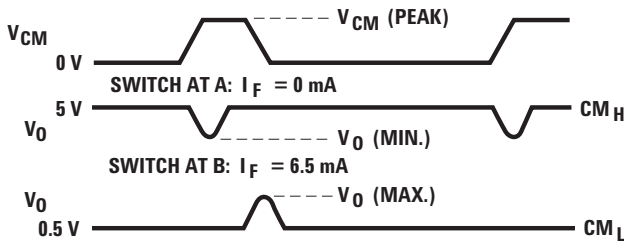
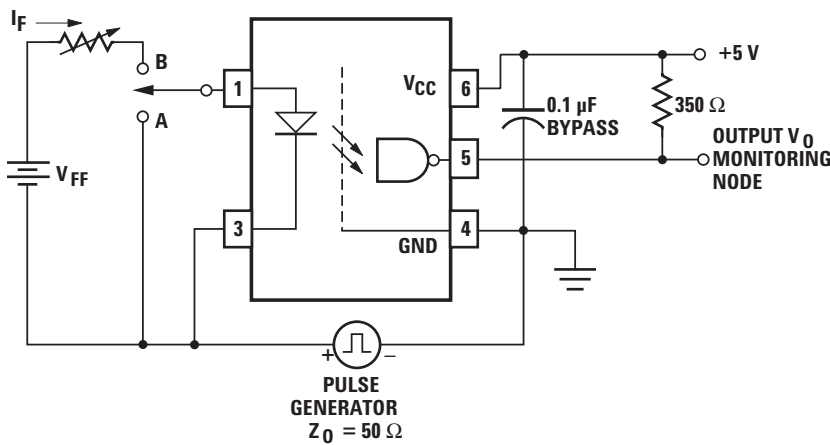

Figure 11. Test Circuit for Common Mode Transient Immunity and Typical Waveforms

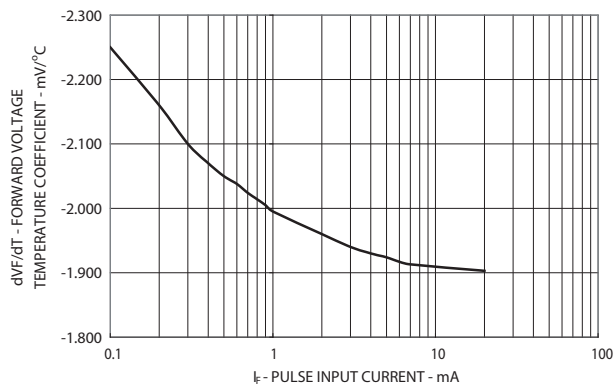

Figure 12. Temperature Coefficient for Forward Voltage vs. Input Current

Propagation Delay, Pulse-Width Distortion and Propagation Delay Skew

Propagation delay is a figure of merit which describes how quickly a logic signal propagates through a system. The propagation delay from low to high (t_{PLH}) is the amount of time required for an input signal to propagate to the output, causing the output to change from low to high. Similarly, the propagation delay from high to low (t_{PHL}) is the amount of time required for the input signal to propagate to the output, causing the output to change from high to low (see Figure 6).

Pulse-width distortion (PWD) results when t_{PLH} and t_{PHL} differ in value. PWD is defined as the difference between t_{PLH} and t_{PHL} and often determines the maximum data rate capability of a transmission system. PWD can be expressed in percent by dividing the PWD (in ns) by the minimum pulse width (in ns) being transmitted. Typically, PWD on the order of 20-30% of the minimum pulse width is tolerable; the exact figure depends on the particular application (RS232, RS422, T-1, etc.).

Propagation delay skew, t_{PSK} , is an important parameter to consider in parallel data applications where synchronization of signals on parallel data lines is a concern. If the parallel data is being sent through a group of optocouplers, differences in propagation delays will cause the data to arrive at the outputs of the optocouplers at different times. If this difference in propagation delays is large enough, it will determine the maximum rate at which parallel data can be sent through the optocouplers.

Propagation delay skew is defined as the difference between the minimum and maximum propagation delays, either t_{PLH} or t_{PHL} , for any given group of optocouplers which are operating under the same conditions (i.e., the same drive current, supply voltage, output load, and operating temperature). As illustrated in Figure 14, if the inputs of a group of optocouplers are switched either ON or OFF at the same time, t_{PSK} is the difference between the shortest propagation delay, either t_{PLH} or t_{PHL} , and the longest propagation delay, either t_{PLH} or t_{PHL} .

As mentioned earlier, t_{PSK} can determine the maximum parallel data transmission rate. Figure 15 is the timing diagram of a typical parallel data application with both the clock and the data lines being sent through optocouplers. The figure shows data and clock signals at the inputs and outputs of the optocouplers. To obtain the maximum data transmission rate, both edges of the clock signal are being used to clock the data; if only one edge were used, the clock signal would need to be twice as fast.

Propagation delay skew represents the uncertainty of where an edge might be after being sent through an optocoupler. Figure 15 shows that there will be uncertainty in both the data and the clock lines. It is important that these two areas of uncertainty not overlap, otherwise the clock signal might arrive before all of the data outputs have settled, or some of the data outputs may start to change before the clock signal has arrived. From these considerations, the absolute minimum pulse width that can be sent through optocouplers in a parallel application is twice t_{PSK} . A cautious design should use a slightly longer pulse width to ensure that any additional uncertainty in the rest of the circuit does not cause a problem.

The t_{PSK} specified optocouplers offer the advantages of guaranteed specifications for propagation delays, pulse-width distortion and propagation delay skew over the recommended temperature, and input current, and power supply ranges.

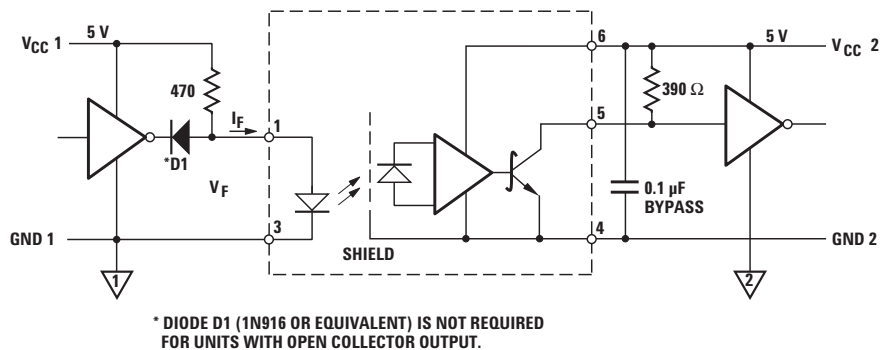

Figure 13. Recommended TTL/LSTTL to TTL/LSTTL Interface Circuit.

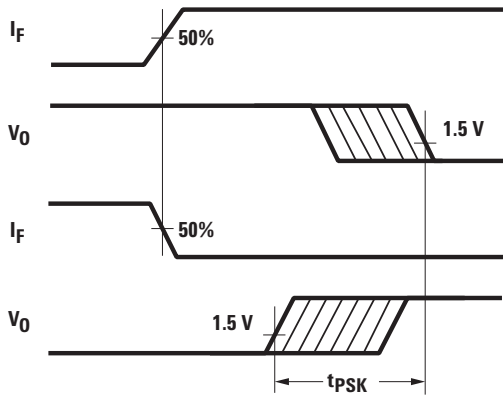

Figure 14. Illustration of Propagation Delay Skew – t_{PSK}

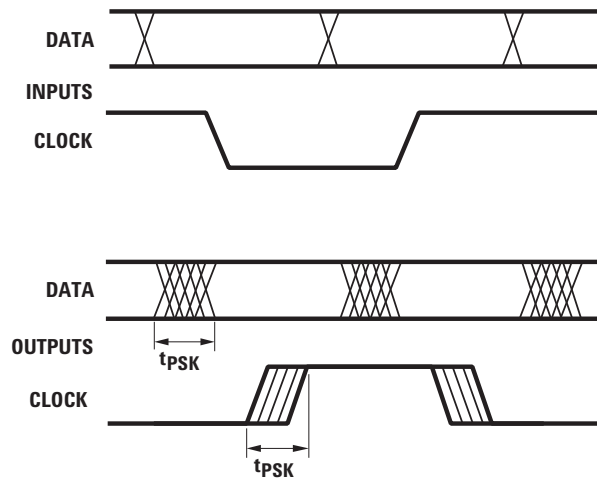

Figure 15. Parallel Data Transmission Example

For product information and a complete list of distributors, please go to our web site: www.avagotech.com

Avago, Avago Technologies, the A logo and R²Coupler™ are trademarks of Avago Technologies in the United States and other countries. Data subject to change. Copyright © 2005-2011 Avago Technologies. All rights reserved. Obsoletes AV01-0610EN AV02-0597EN - March 7, 2011

