



LCD Module Technical Specification

First Edition
Dec 29, 2000
Final Revision

T-51380L050J-FW-P-AC

Checked by (Quality Assurance Div.)

Checked by (Design Engineering Div.)

Prepared by (Production Div.)

Table of Contents

1. Application.....	2
2. Features.....	2
3. Mechanical Specifications	2
4. Mechanical Drawing of module	3
5. Input/output Terminals.....	4
6. Absolute Maximum Ratings.	5
7. Electrical Characteristics	5
8. Optical Characteristics.....	11
9. Handling Cautions	14
10. Reliability Test.....	15
11. Indication of Lot Number Label	15

Revision History

Rev.	Date	Page	Comment

1. Application

This technical specification applies to 5" color TFT-LCD module.

2. Features

- . Compatible with PAL system
- . Composite Video input , Standard RGB signal input and VGA mode
- . Pixel in stripe configuration
- . Slim and compact
- . Active area / Outline area = 66.5 %
- . Viewing Direction : 6 o'clock
- . Polarizer: Anti-glare
- . DC-DC Converter: Assembled
- . DC-AC Inverter: Assembled

3. Mechanical Specifications

Parameter	Specifications	Unit
Screen Size	5 (diagonal)	inch
Display Format	960×234	dot
Active Area	102.6(H)×73.9 (V)	mm
Dot Pitch	0.107 (H)×0.316 (V)	mm
Pixel Configuration	Stripe	
Outline Dimension	127.0 (w)×92.8(H)×18.5(D)	mm
Weight	230±10	g

4. Mechanical Drawing of TFT-LCD Module

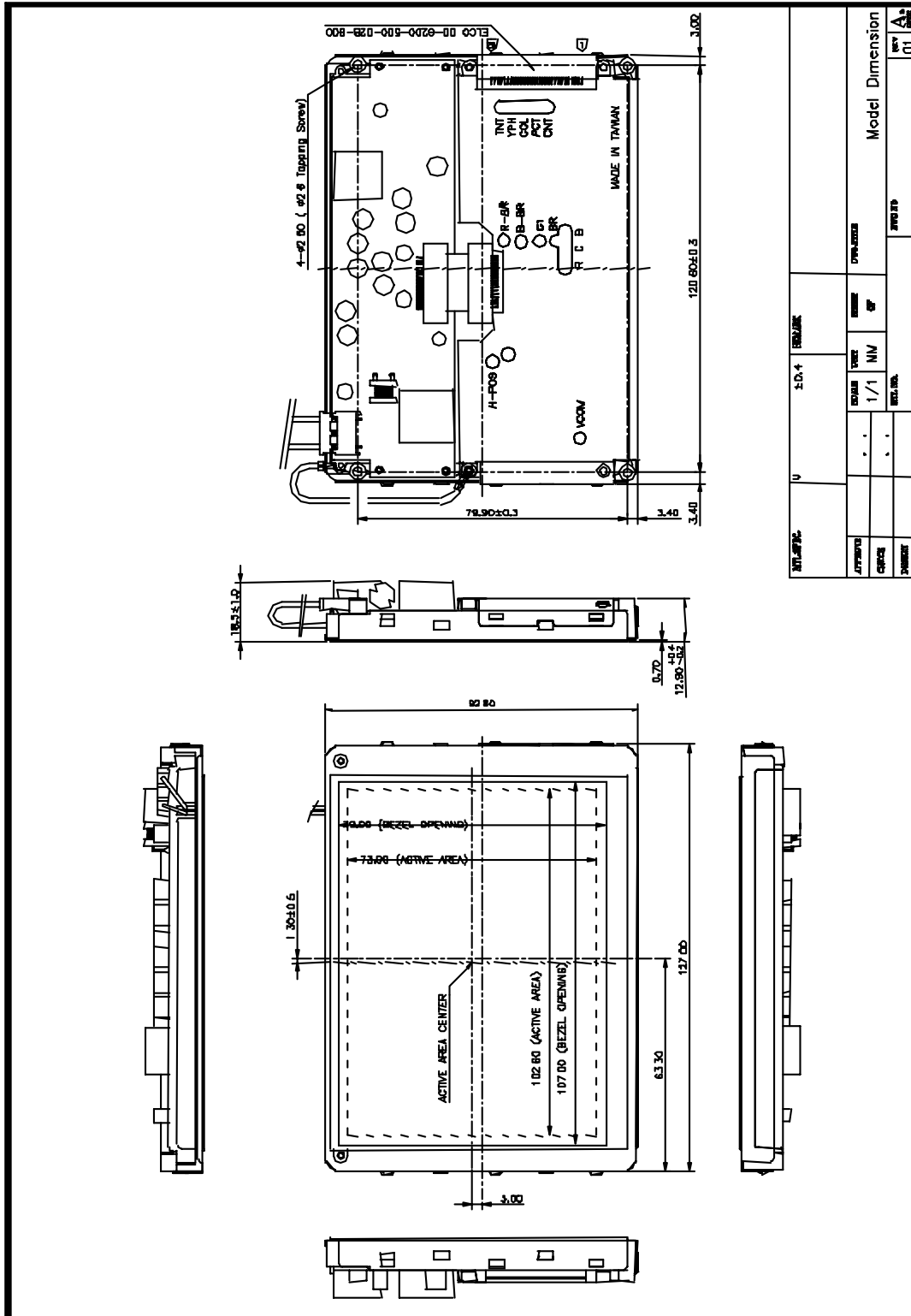

PART NO.		S.D. #		REV. NO.		DATE	
REV. 01	REV. 02	REV. 03	REV. 04	REV. 05	REV. 06	REV. 07	REV. 08
DATE	DATE	DATE	DATE	DATE	DATE	DATE	DATE
DESIGNER	1/1	MM	ØP	Model Dimension			
CHECKER							
APPROVED							

5.Input / Output Terminals
5-1) TFT-LCD Panel Driving

28 PIN				
Pin No	Symbol	I/O	Description	Remark
1	BRI	I	Brightness adjustment	Note 5-1
2	CNT	I	Contrast adjustment	Note 5-1
3	PCT	I	Picture adjustment	Note 5-1
4	COL	I	Color adjustment	Note 5-1
5	NC		No connection	
6	VIN	I	Composite video input	
7	GND	I	Video ground	
8	B	I	Video signal (blue)	Note 5-2
9	G	I	Video signal (green)	Note 5-2
10	R	I	Video signal (red)	Note 5-2
11	SW	I	Composite or RGB input selection pin	Note 5-3
12	RL	I	Right or left direction selection pin	Note 5-4
13	VIY	I	Vertical sync. input	
14	CSY	I	Composite sync. or horizontal sync. input	Note 5-5
15	VSY	I/O	Vertical sync. input/output	Note 5-5
16	HSY	I/O	Horizontal sync. input/output	Note 5-5
17	CKC	I	Control pin for select I/O signal	Note 5-5
18	VGA	I	VGA function select pin	Note 5-6
19	HPS	I	H-position adjustment	Note 5-1
20	GND	I	Ground	
21	VDD	I	+5V power output	
22	12G2	I	12V _{DC} power input ground	Note 5-9
23	12G1	I	12V _{DC} power input ground	Note 5-9
24	12V2	I	12V _{DC} power input	Note 5-9
25	12V1	I	12V _{DC} power input	Note 5-9
26	GND	I	Ground	
27	DIM	I	Dimmer adjustment for inverter	Note 5-7, 5-9
28	ENB	I	Enable signal for inverter	Note 5-8, 5-9

Note 5-1: It will be used the default value if the pin is opened ◦

Note 5-2: 0.7 V_{PP} standard RGB signal ◦

Note 5-3: Default (Hi, 5V) RGB input ◦

Note 5-4: Default (Hi, 5V) shift right ◦

Note 5-5: CKC pin can select the function of pin 16,15,14 as following:

Pin 13 (CKC)	Pin 16(HSY)	Pin 15(VSY)	Pin 14(CSY)
Hi	HSY output	VSY output	CSY output
Low	External HSY input	External VSY input	External clock input (18.9MHz)

Note 5-6: Hi(+5V) for VGA input, Low(0V, default) for NTSC or RGB input ◦

The relationship of SW pin & VGA pin is defined as following table:

SW	VGA	Selected input
0	0	TV mode - Composite input
0	1	NO USE
1	0	TV mode - R.G.B. input
1	1	VGA input

Note 5-7: Range: 0~2 ; open (default) : full light

Note 5-8: 0V to shunt down; 5V or open to enable

Note 5-9: These pins direct pass to the Switching Power Supply 16pin connector

5-2) Input / Output Connector

A) Video Input Connector

ELCO 00-6200-500-028-800

Down Connector

Pin No. : 28

Pitch : 1.0 mm

6. Absolute Maximum Ratings:

Parameter	Symbol	MIN.	MAX.	Unit	Remark
Supply voltage for Module	+12V	0	+1.8	V	
External COLOR control	COL	0	+5.5	V	
External BRIGHTNESS control	BRT	0	+5.5	V	
External CONTRAST control	CNT	0	+5.5	V	
Storage Temperature		-30	+80	C	
Operation Temperature		-10	+60	C	

7. Electrical Characteristics

7-1) Recommended Operating Conditions:

A) Driving for TFT-LCD panel

GND = 0V , Ta = 25 C

Parameter	Symbol	MIN.	TYP	MAX.	Unit	Remark
Supply voltage for Module	+12V	+10	+12	+16	V	
Supply voltage for controller	I _{+12V}		0.55		A	

7-2) Input/Output signal chart

Parameter		Symbol	MIN.	TYP.	MAX.	Unit	Remarks
Horizontal Sync. Output Pulse	Width	T_{HO}	4.2	4.7	5.2	μs	
	Phase Difference	T_{HP}	0	2		μs	
	Rising Time	T_{HR}	-	-	0.5	μs	
	Falling Time	T_{HF}	-	-	0.5	μs	
Vertical Sync. Output Pulse	Width	T_{VO}	-	4H	-	μs	H=1/15.75KHZ
	Phase Difference	T_{VPO}	-	1H	-	μs	odd field
	Phase Difference	T_{VPE}	-	1.5H	-	μs	even field
	Rising Time	T_{VR}	-	-	2	μs	
	Frequency	f_{FRP}	7.67	7.87	8.07	KHZ	
Polarity Alternating Signal	Delay time	T_{FD}	-	-	4	μs	
	Falling Time	T_{VF}	-	-	2	μs	

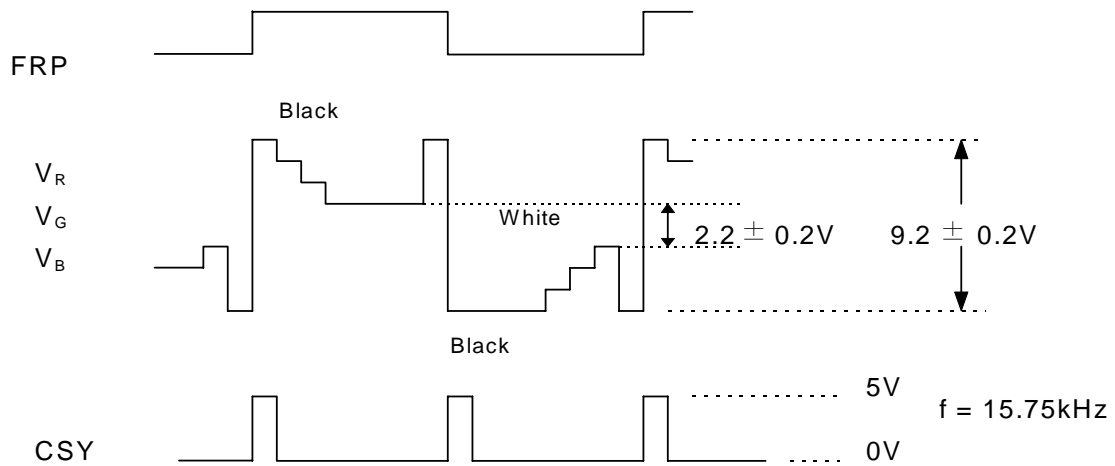

7-3) Display Time Range

When sync. signal of PAL system is applied.

a) Horizontally

13.0 ~ 63.8 μ s

b) Vertical

26 ~ 298 H

- c) odd field : Scan lines $14n+17$ $14n+23$ ($n = 1, 2, 3..$) are not displayed.
even field : Scan lines $14n+12$ $14n+20$ ($n = 1, 2, 3..$) are not displayed.

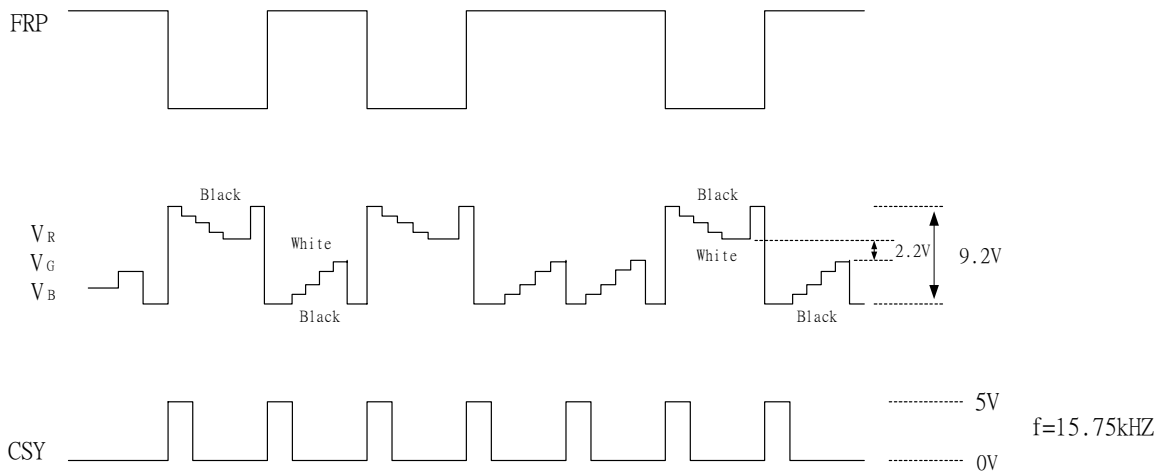

c) PAL Timing Diagram

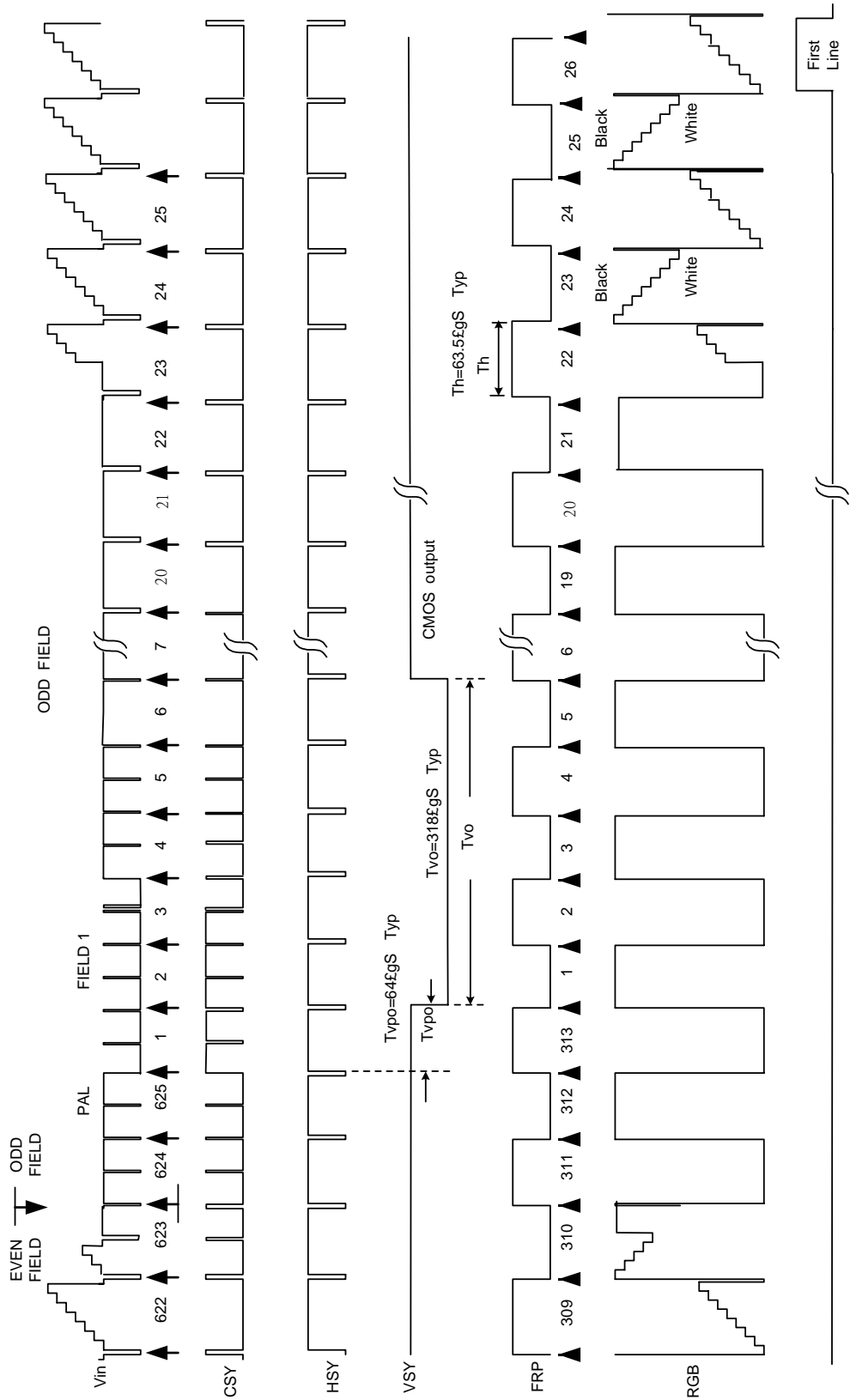

Timing chart of I/O and RGB signal

PAL Display Timing

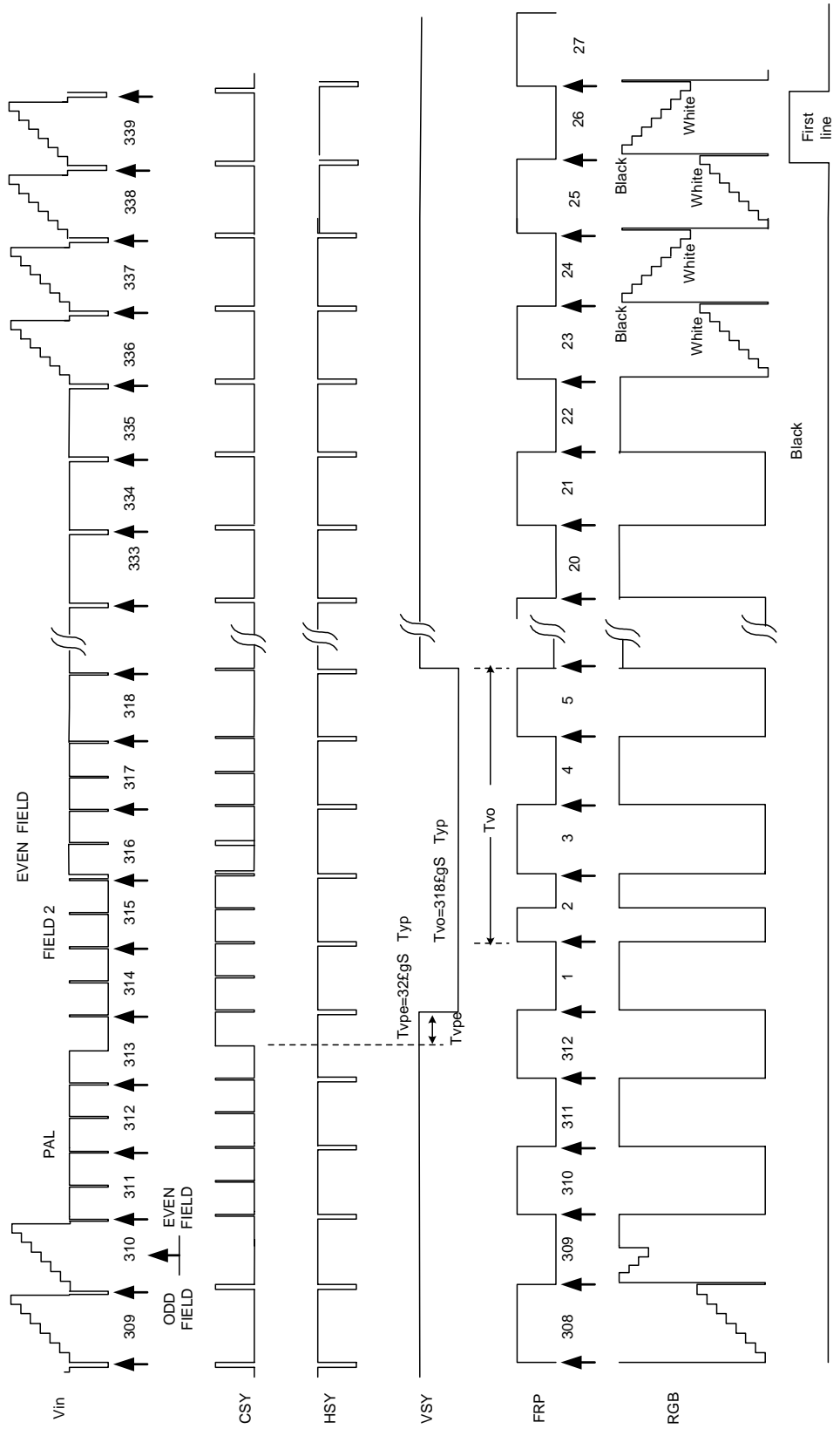

Timing chart of I/O and RGB signal

Downloaded from Elcodis.com electronic components distributor

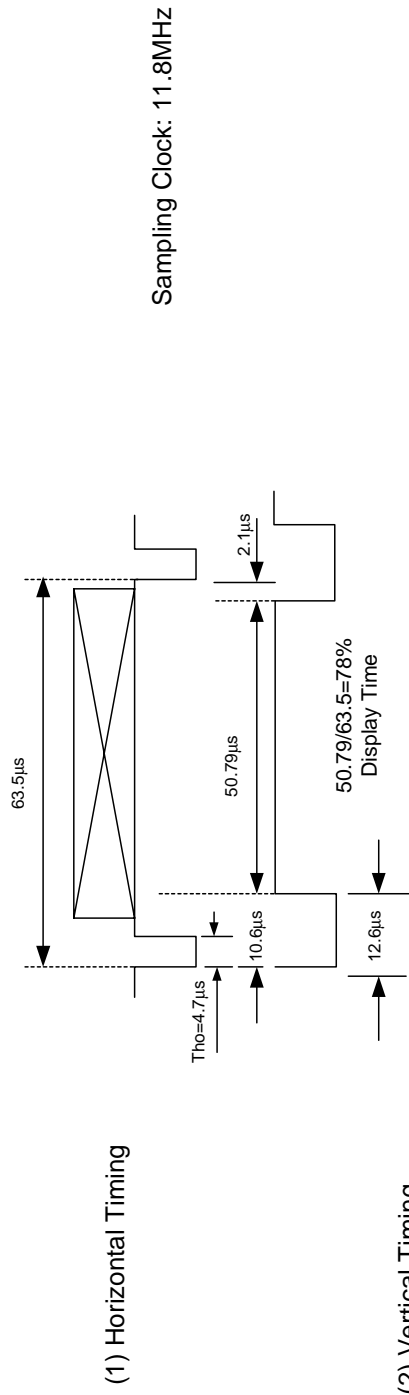

Downloaded from Elcodis.com electronic components distributor

8. Optical Characteristics

8-1) Specification:

Ta = 25C

Parameter	Symbol	Condition	MIN.	TYP.	MAX.	Unit	Remarks
Viewing Angle	Horizontal	θ	± 45	± 55		deg	Note 8-1
	Vertical	θ (to 12 o'clock)	30	35		deg	Note 8-1
		θ (to 6 o'clock)	10	15		deg	Note 8-1
Contrast Ratio	CR		80	120			Note 8-1, 8-2
Response time	Rise	Tr			30	ms	Note 8-4
	Fall	Tf			50	ms	
Brightness			300	320		cd/m ²	Note 8-3
White Chromaticity	x		0.250	0.305	0.350		Note 8-3
	y		0.300	0.350	0.400		
Lamp Life Time(+25C)		Continuous	10,000			hr	

Note 8-1: The definitions of viewing angles

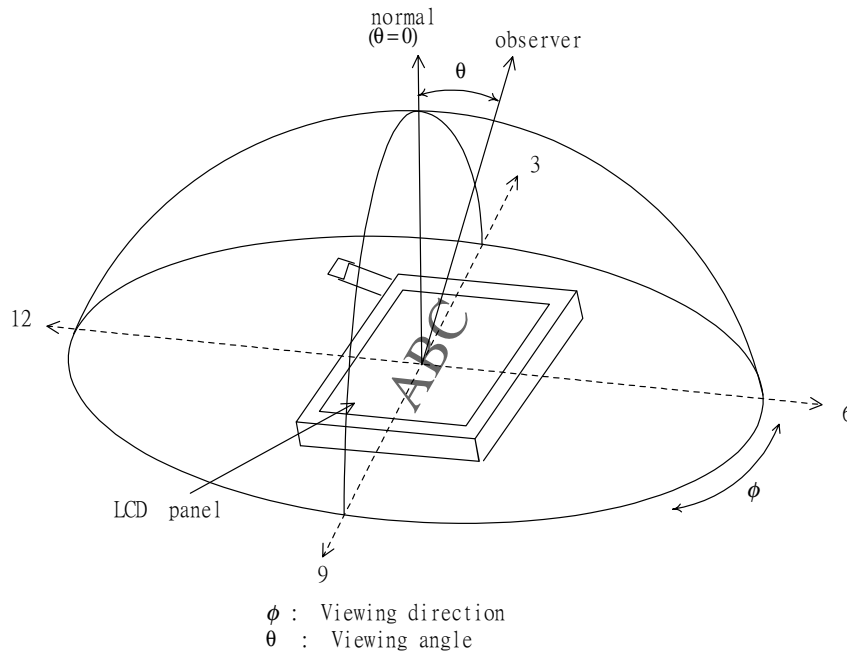

Note 8-2 : CR = $\frac{\text{Luminance when Testing point is White}}{\text{Luminance when Testing point is Black}}$
 Contrast Ratio is measured in optimum common electrode voltage.
 (Testing configuration see 8-2)

Note 8-3 : Topcon BM-7(fast) luminance meter 2° field of view is used in the testing (after

20~30 minutes operation).
Lamp Current 6mA

Note 8-4: The definition of response time:

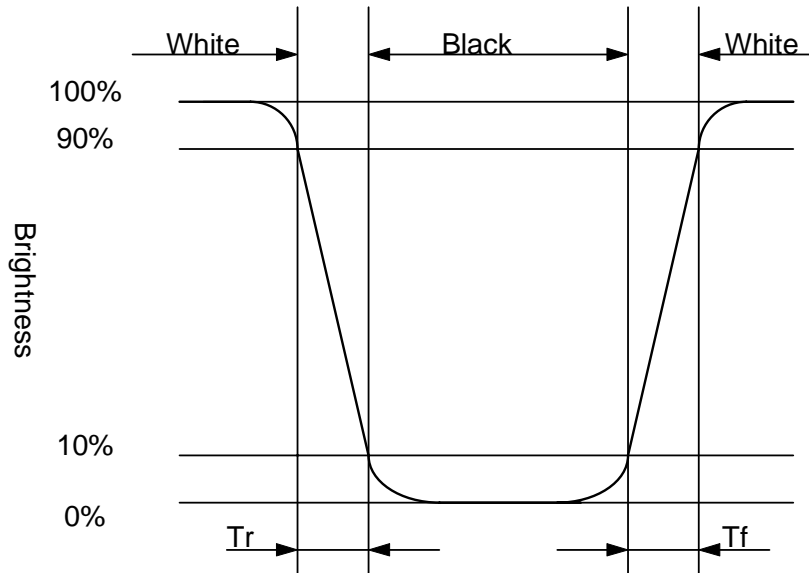

8-2) Testing configuration

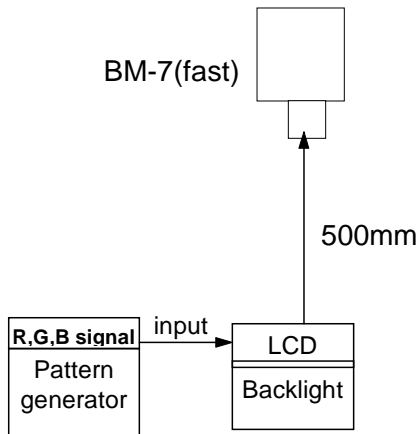

Caution: 1. Environmental illumination 1 lux
 2. Before test CR, Vcom voltage must be adjusted carefully to get the best CR.

- LCD Display

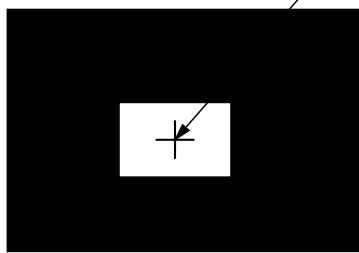

Pattern A

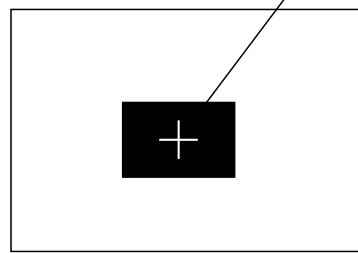

Pattern B

- R, G, B Waveform of Pattern A at Testing Point

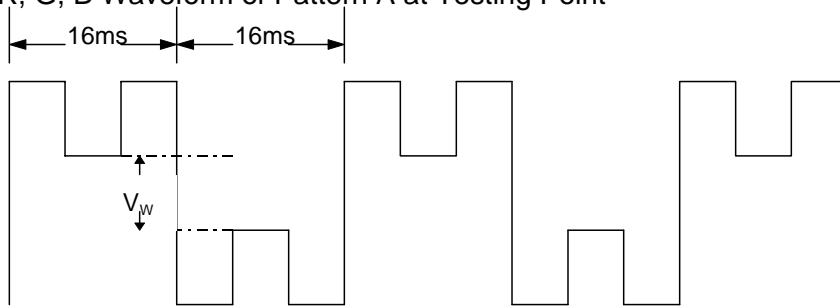

$$V_w = 2.2V \pm 0.2V$$

- G, B Waveform of Pattern B at Testing Point

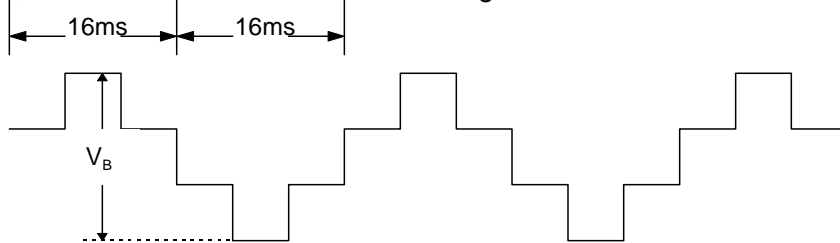

$$V_b = 9.2V \pm 0.2V$$

9. Handling Cautions

9-1) Mounting of module

- a) Please power off the module when you connect the input/output connector.
- b) Please connect the ground pattern of the inverter circuit surely. If the connection is not perfect, some following problems may happen possibly.
 - 1. The noise from the backlight unit will increase.
 - 2. The output from inverter circuit will be unstable.
 - 3. In some cases a part of module will heat.
- c) Polarizer which is made of soft material and susceptible to flaw must be handled carefully.
- d) Protective film (Laminator) is applied on surface to protect it against scratches and dirt. It is recommended to peel off the laminator before use and taking care of static electricity.

9-2) Precautions in mounting

- a) When metal part of the TFT-LCD module (shielding lid and rear case) is soiled, wipe it with soft dry cloth.
- b) Wipe off water drops or finger grease immediately. Long contact with water may cause discoloration or spots.
- c) TFT-LCD module uses glass which breaks or cracks easily if dropped or bumped on hard surface. Please handle with care.
- d) Since CMOS LSI is used in the module. So take care of static electricity and earth yourself when handling.

9-3) Adjusting module

- a) Adjusting volumes on the rear face of the module have been set optimally before shipment.
- b) Therefore, do not change any adjusted values. If adjusted values are changed, the specifications described may not be satisfied.

9-4) Others

- a) Do not expose the module to direct sunlight or intensive ultraviolet rays for many Hours.
- b) Store the module at a room temperature place.
- c) The voltage of beginning electric discharge may over the normal voltage because of leakage current from approach conductor by to draw lump read lead line around.
- d) If LCD panel breaks, it is possibly that the liquid crystal escapes from the panel. Avoid putting it into eyes or mouth. When liquid crystal sticks on hands, clothes or feet. Wash it out immediately with soap.
- e) Observe all other precautionary requirements in handling general electronic components.
- f) Please adjust the voltage of common electrode as material of attachment by 1 module.

10. Reliability Test

No	Test Item	Test Condition
1	High Temperature Storage Test	Ta = +80 C, 240 hr
2	Low Temperature Storage Test	Ta = -30 C, 240 hr
3	High Temperature Operation Test	Tp = +60 C, 240 hr
4	Low Temperature Operation Test	Tp = -10 C, 240 hr
5	High Temperature & High Humidity Operation Test	Tp = +60 C, 95% RH, 240 hr
6	Thermal Cycling (non-operating)	-25C → +25C → +70C 30 min/5min/30 min
7	Vibration Test (non-operating)	Frequency : 10 ~ 55 Hz Amplitude : 1.5 mm Sweep time: 11 min Test period: 6 Cycles for each direction of X, Y, Z
8	Shock Test (non-operation)	100G,6ms ,X,Y,Z 3 times for each direction Cycle: 3 times
9	Electron Static Discharge (non-operation)	C=150pF , R=150 ohm Contact=±8KV , Air=±15KV 10 times / point, 5 points/panel face

Ta: ambient temperature

[Criteria]

Under the display quality test conditions with normal operation state, there should be no change which may affect practical display function.

11. Indication of Lot Number Label

a) Indicated contents of the label

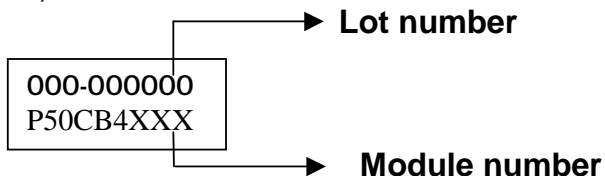

Contents of lot number : 1st—Process area : class 1000 ⇒ H
class 100K ⇒ M

2nd~3rd—Module screen size(in inch) : 1.8"⇒18, 2.5"⇒25.....

5th—Production year : 1999⇒9, 2000⇒A, 2001⇒1.....

6th—Production month : 1, 2, 3,...9, A, B, C

7th~10th—Serial numbers : 0001~9999