

# User's Guide

# **NHD-16032AZ-NSW-BBW**

# **LCM**

(Liquid Crystal Display Graphic Module)

**RoHS Compliant**

<b>NHD-</b>	Newhaven Display
<b>16032-</b>	160 x 32 Dots
<b>AZ-</b>	Version Line
<b>N-</b>	Transmissive
<b>SW-</b>	Side White LED B/L
<b>B-</b>	STN- (negative) Blue
<b>B-</b>	6:00 View
<b>W-</b>	Wide Temperature (-20 ~ +70c)

For product support, contact

---

**Newhaven Display International**  
**2511 Technology Drive, #101**  
**Elgin, IL 60124**

Tel: (847) 844-8795 Fax: (847) 844-8796

November 19, 2008

**DOCUMENT REVISION HISTORY**

VERSINO	DATE	DESCRIPTION	CHANGED BY
00	Nov-18-2008	First issue	

**CONTENTS**

Item	Page
Functions & Features	3
Mechanical specifications	3
Dimensional Outline	4
Absolute maximum ratings	5
Block diagram	5
Pin description	5
Optical characteristics	6
Electrical characteristics	6
Timing Characteristics	6-8
Display RAM	9-11
Instruction description	12-15
Quality Specifications	16--23

**1. Features**

1. Dot matrix LCD module
2. 160X32dots
3. 4-bit or 8-bit MPU interfaces
4. Built-in controller (SPLC780D or equivalent)
5. Display Mode & Backlight Variations
6. ROHS Compliant

<b>LCD type</b>	<input type="checkbox"/> TN			
	<input type="checkbox"/> FSTN	<input type="checkbox"/> FSTN Negative		
	<input type="checkbox"/> STN Yellow Green	<input type="checkbox"/> STN Gray		<input checked="" type="checkbox"/> STN Blue Negative
<b>View direction</b>	<input checked="" type="checkbox"/> 6 O'clock		<input type="checkbox"/> 12 O'clock	
<b>Rear Polarizer</b>	<input type="checkbox"/> Reflective		<input type="checkbox"/> Transflective	<input checked="" type="checkbox"/> Transmissive
<b>Backlight Type</b>	<input checked="" type="checkbox"/> LED	<input type="checkbox"/> EL	<input type="checkbox"/> Internal Power	<input type="checkbox"/> 3.0V Input
		<input type="checkbox"/> CCFL	<input checked="" type="checkbox"/> External Power	<input checked="" type="checkbox"/> 5.0V Input
<b>Backlight Color</b>	<input checked="" type="checkbox"/> White	<input type="checkbox"/> Blue	<input type="checkbox"/> Amber	<input type="checkbox"/> Yellow-Green
<b>Temperature Range</b>	<input type="checkbox"/> Normal		<input checked="" type="checkbox"/> Wide	<input type="checkbox"/> Super Wide
<b>DC to DC circuit</b>	<input type="checkbox"/> Build-in			<input checked="" type="checkbox"/> Not Build-in
<b>Touch screen</b>	<input type="checkbox"/> With			<input checked="" type="checkbox"/> Without
<b>Font type</b>	GB code simplified character set			

**2. MECHANICAL SPECIFICATIONS**

Module size	114.0mm(L)*40.0mm(W)* Max13.5(H)mm
Viewing area	64.5mm(L)*16.4mm(W)
Dot size	0.49mm(L)*0.49mm(W)
Dot pitch	0.54mm(L)*0.54mm(W)
Weight	Approx.

### 3. Outline dimension

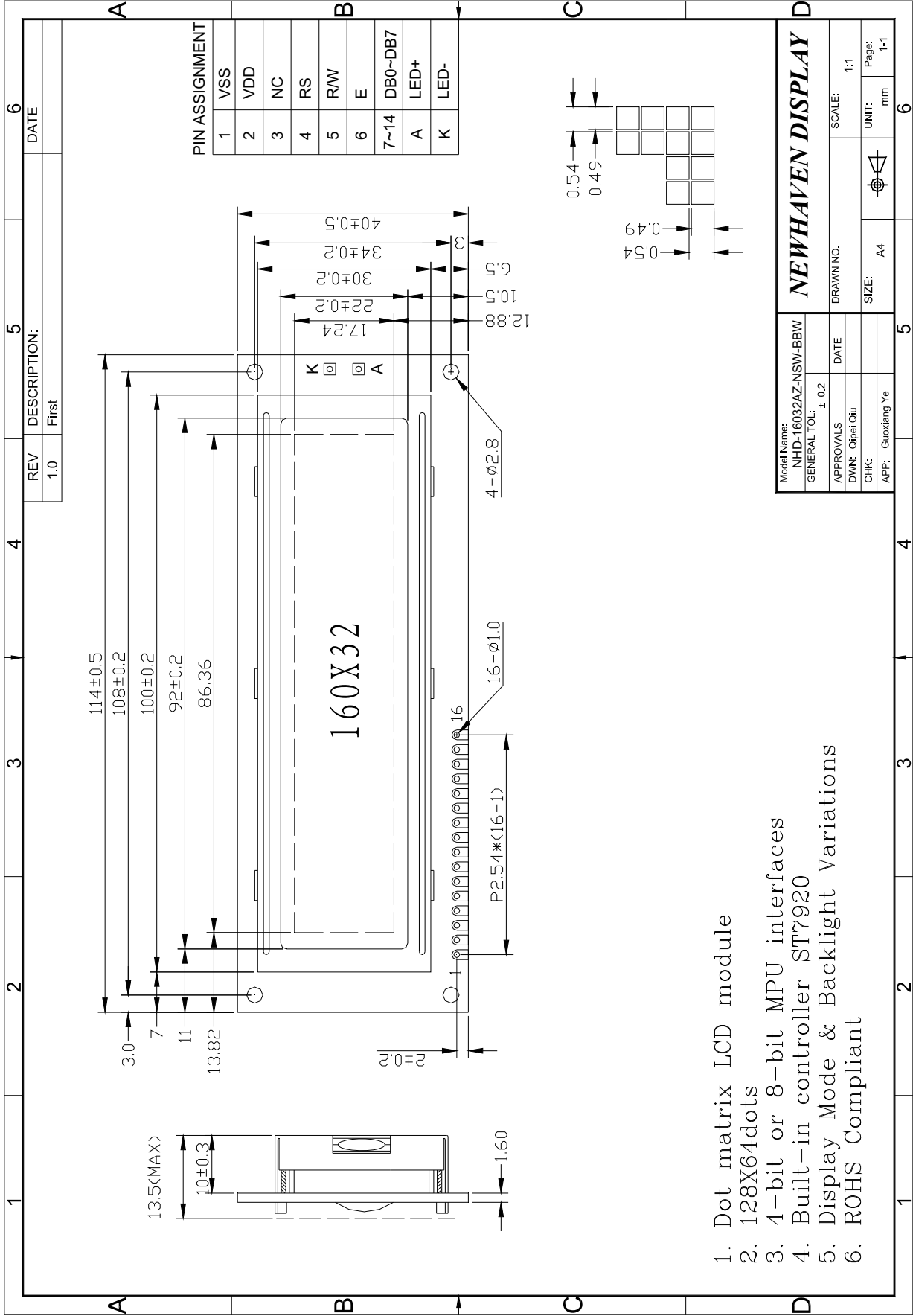

#### 4. Absolute maximum ratings

Item	Symbol	Standard			Unit
Power voltage	$V_{DD}-V_{SS}$	0	-	7.0	V
Input voltage	$V_{IN}$	VSS	-	VDD	
Operating temperature range	$V_{OP}$	-20	-	+70	
Storage temperature range	$V_{ST}$	-30	-	+80	

#### 5. Block diagram

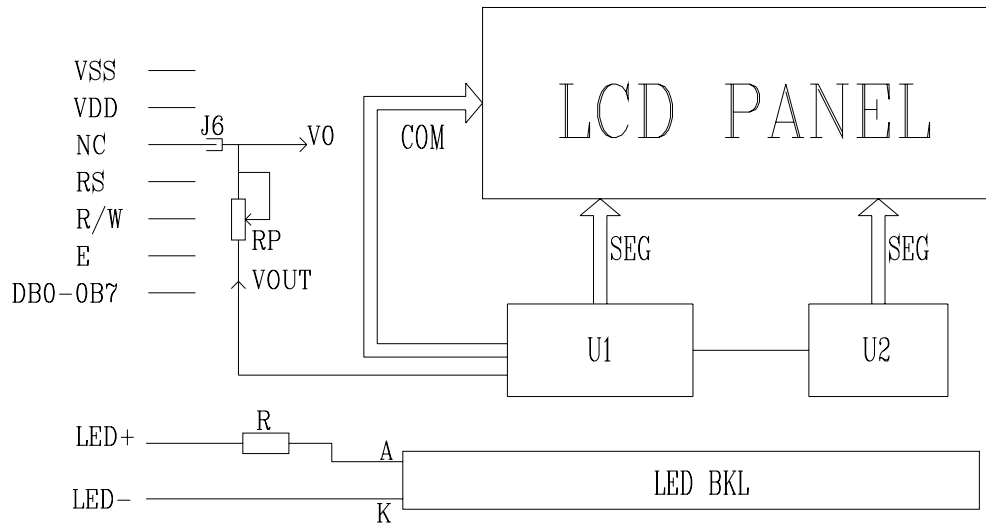

#### 6. Interface pin description

Pin no.	Symbol	External connection	Function
1	Vss	Power supply	Signal ground for LCM
2	V <sub>DD</sub>		Power supply for logic for LCM
3	NC		
4	RS	MPU	Register select signal
5	R/W	MPU	Read/write select signal
6	E	MPU	Operation (data read/write) enable signal
7~10	DB0~DB3	MPU	Four low order bi-directional three-state data bus lines. Used for data transfer between the MPU and the LCM. These four are not used during 4-bit operation.
11~14	DB4~DB7	MPU	Four high order bi-directional three-state data bus lines. Used for data transfer between the MPU
15	LED+	LED BKL power supply	Power supply for BKL
16	LED-		Power supply for BKL

## 7. Optical characteristics

TN type display module (Ta=25 , VDD=5.0V)

Item	Symbol	Condition	Min.	Typ.	Max.	Unit
Viewing angle		Cr 4	-25	-	-	deg
			-30	-	30	
Contrast ratio	Cr		-	2	-	-
Response time (rise)	Tr	-	-	120	150	ms
Response time (fall)	Tr	-	-	120	150	

STN type display module (Ta=25 , VDD=5.0V)

Item	Symbol	Condition	Min.	Typ.	Max.	Unit
Viewing angle		Cr 2	-60	-	35	deg
			-40	-	40	
Contrast ratio	Cr		-	6	-	-
Response time (rise)	Tr	-	-	150	250	ms
Response time (fall)	Tr	-	-	150	250	

## 8. Electrical characteristics

DC characteristics

Parameter	Symbol	Conditions	Min.	Typ.	Max.	Unit
Supply voltage for LCD	V <sub>DD-V0</sub>	Ta =25	-	-	-	V
Input voltage	V <sub>DD</sub>		4.5	5.0	5.5	
Supply current	I <sub>DD</sub>	Ta=25 , V <sub>DD</sub> =5.0V	-	1.5	2.0	mA
Input leakage current	I <sub>LKG</sub>		-	-	1.0	uA
“H” level input voltage	V <sub>IH</sub>		2.2	-	V <sub>DD</sub>	V
“L” level input voltage	V <sub>IL</sub>	Twice initial value or less	0	-	0.6	
“H” level output voltage	V <sub>OH</sub>	LOH=-0.25mA	2.4	-	-	
“L” level output voltage	V <sub>OL</sub>	LOH=1.6mA	-	-	0.4	
Backlight supply voltage	V <sub>F</sub>		-	5.0	-	
Backlight supply current	I <sub>LED</sub>	V <sub>F</sub> =5.0V R=68OHM	30	-	40	mA

## 9. Timing Characteristics

Write/ Read cycle (Ta=25 , VDD=5.0V)

Parameter	Symbol	Test pin	Min.	Typ.	Max.	Unit
Enable cycle time	t <sub>c</sub>	E	1200	-	-	ns
Enable pulse width	t <sub>PW</sub>		140	-	-	
Enable rise/fall time	t <sub>R</sub> t <sub>F</sub>		-	-	25	
Address setup time	T <sub>AS</sub>	RS; R/W;E	10	-	-	
Address hold time	T <sub>AH</sub>	RS; R/W;E	20	-	-	
Data setup time	T <sub>DSW</sub>	DB0~DB7	40	-	-	
Data hold time	T <sub>H</sub>		20	-	-	
Enable cycle time	T <sub>c</sub>	E	1200	-	-	ns
Enable pulse width	T <sub>PW</sub>		140	-	-	
Enable rise/fall time	T <sub>R</sub> T <sub>F</sub>		-	-	25	
Address setup time	T <sub>AS</sub>	RS; R/W;E	10	-	-	
Address hold time	T <sub>AH</sub>	RS; R/W;E	20	-	-	
Data setup time	T <sub>DDR</sub>	DB0~DB7	-	-	100	
Data hold time	T <sub>H</sub>		20	-	-	

Write mode timing diagram

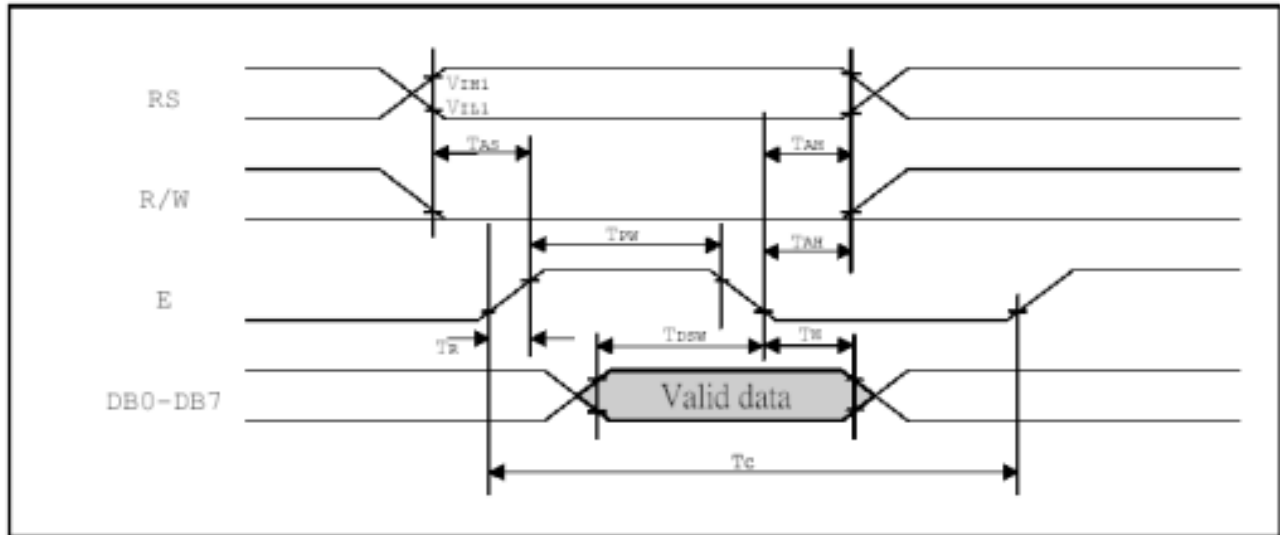

Read mode timing diagram

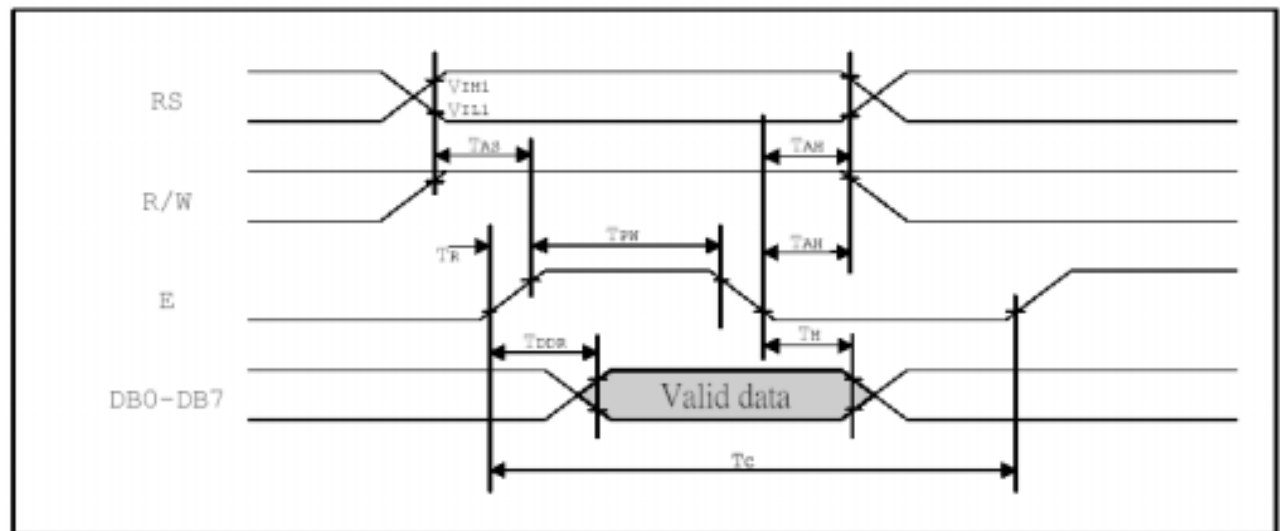

**Parallel interface :**

ST7920 is in parallel mode by pulling up PSB pin. And can select 8 bit or 4-bit bus interface by function set instruction DI control bit. MPU can control ( RS , RW , E , and DB0..DB7 ) pins to complete the data transmission.

In 4-bit transfer mode, every 8 bits data or instruction is separated into 2 parts. Higher 4 bits ( DB7-DB4 ) data will transfer first and placed into data pins ( DB7-DB4 ) . Lower 4 bits ( DB3-DB0 ) data will transfer second and placed into data pins ( DB7-DB4 ) , (DB3-DB0) data pins are not used.

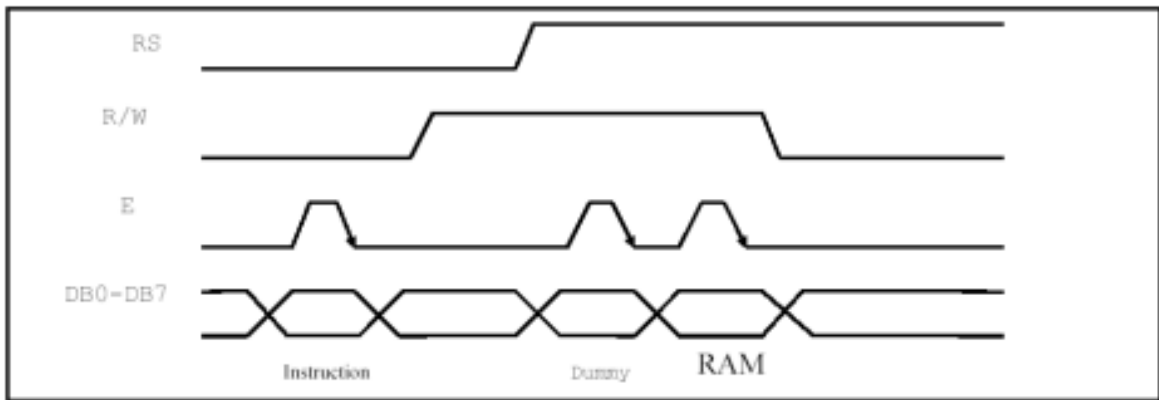

Timing Diagram of 8-bit Parallel Bus Mode Data Transfer

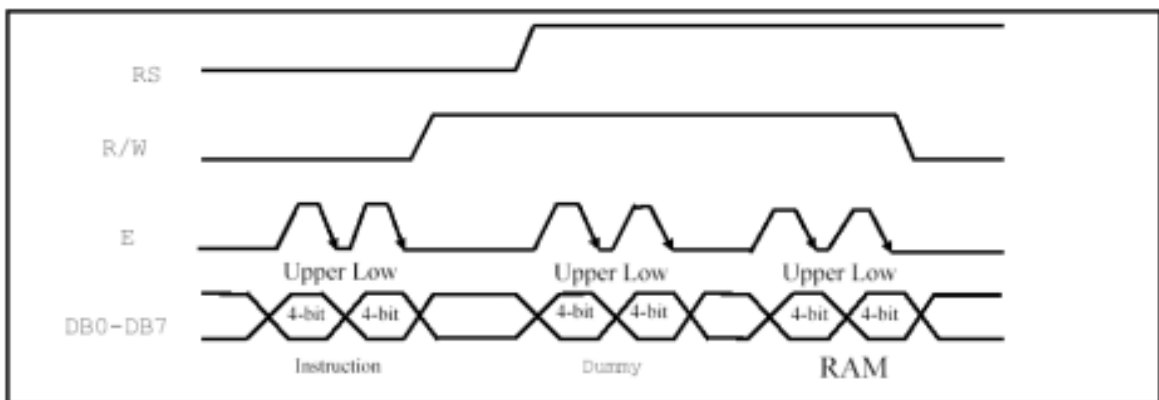

Timing Diagram of 4-bit Parallel Bus Mode Data Transfer



### 10. Display data RAM(DDRAM)

There are 64x2 bytes for display data RAM area. Can store display data for 16 characters(16x16) by 4 lines or 32 characters(8x16) by 4 lines. However, only 2 lines can be displayed at a time. Character codes stored in DDRAM point to the fonts specified by CGROM · HCGROM and CGRAM. ST7920 display half height HCGROM fonts, user-defined CGRAM fonts and full 16x16 CGROM fonts. Data codes 0000H ~ 0006H are for CGRAM user-defined fonts. Data codes 02H ~ 7FH are for half height alpha numeric fonts. Data codes ( A140 ~ D75F ) are for BIG5 code and (A1A0 ~ F7FF) are for GB code.

1. display HCGROM fonts : Write 2 bytes data to DDRAM to display two 8x16 fonts. Each byte represents 1 character font. The data of each byte is 02H ~ 7FH.
2. display CGRAM fonts : Write 2 bytes data to DDRAM to display one 16x16 font. Only 0000H · 0002H · 0004H · 0006H are allowed.
3. display CGROM fonts : Write 2 bytes data to DDRAM to display one 16x16 font.  
A140H ~ D75FH are for (BIG5) code, A1A0H ~ F7FFH are for (GB) code.

Higher byte ( D15 ~ D8 ) are written first and then lower byte ( D7 ~ D0 ) .

Refer to Table 5 for address map

CGRAM fonts and CGROM fonts can only be displayed in the start position of each address. (Refer to Table 4)

80	81	82	83	84	85	86	87	88	89	8A	8B	8C	8D	8E	8F
H L	H L	H L	H L	H L	H L	H L	H L	H L	H L	H L	H L	H L	H L	H L	H L
S	i	t	r	o	n	i	x		S	T	7	9	2	0	
矽	創	電	子	.	.	中	文	編	碼	(	正	確	)		
矽	創	電	子	.	.	中	文	編	碼						

Table 4

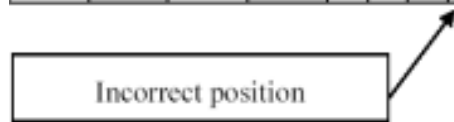

#### Graphic RAM (GDRAM)

Graphic display RAM supports 64x256 bits bit-mapped memory space. GDRAM address is set by writing 2 consecutive bytes for vertical address and horizontal address. Two-bytes data write to GDRAM for one address. Address counter will automatically increase by one for the next two-byte data. The procedure is as followings.

1. Set vertical address ( Y ) for GDRAM
2. Set horizontal address ( X ) for GDRAM
3. Write D15 ~ D8 to GDRAM 中(first byte)
4. Write D7 ~ D0 to GDRAM 中(second byte)

Graphic display memory map please refer to Table-8

#### LCD driver

LCD driver have 33 common and 64 segments to drive the LCD panel. Segment data from CGRAM /CGROM /HCGROM are shifted into the 64 bits segment latches to display. Extended segment driver ST7921 can be used to extend the segment drivers to 256.

DDRAM data (char. code)				CGRAM Addr.				CGRAM data (higher byte)				CGRAM data (lower byte)														
B15~B4	B3	B2	B1	B5	B4	B3	B2	B1	B0	D15	D14	D13	D12	D11	D10	D9	D8	D7	D6	D5	D4	D3	D2	D1	D0	
0	X	00	X	00						0	0	0	0	0	0	0	0	1	0	0	0	0	0	0	0	
										0	0	0	1	1	1	1	1	1	0	0	1	0	0	0	0	0
										0	0	1	0	0	0	1	0	0	0	0	0	1	0	0	0	1
										0	0	1	1	0	0	0	0	0	0	1	1	1	1	1	1	0
										0	1	0	0	0	0	1	0	0	1	0	0	0	0	0	1	0
										0	1	0	1	0	0	1	1	1	0	0	1	0	0	0	0	1
										0	1	1	0	0	1	0	0	1	0	1	0	1	0	0	1	0
										0	1	1	1	0	1	0	0	1	1	0	0	1	0	0	1	0
										1	0	0	0	0	1	0	0	1	0	0	0	1	0	1	0	0
										1	0	0	1	0	0	1	0	0	0	0	0	1	0	0	0	0
										1	0	1	0	0	0	1	0	0	0	0	0	1	0	0	0	0
										1	0	1	1	0	0	1	1	0	0	0	0	1	0	0	0	0
										1	1	0	0	0	0	1	0	0	0	1	0	0	0	0	0	0
										1	1	0	1	0	0	0	0	0	0	0	1	0	0	0	0	0
										1	1	1	0	0	0	0	0	0	0	0	0	0	0	0	0	0
										1	1	1	1	0	0	0	0	0	0	0	0	0	0	0	0	0
										1	1	1	1	0	1	0	0	0	0	0	0	0	0	0	0	0
										1	0	0	0	0	1	0	0	0	0	0	1	0	0	0	0	0
										1	0	0	1	0	1	1	1	1	0	0	1	0	0	0	0	0
										1	0	0	1	0	0	0	0	0	0	0	1	0	0	0	0	0
										1	0	1	0	1	0	1	1	1	0	0	1	0	0	0	0	0
										1	1	0	0	1	0	0	0	0	0	1	0	0	0	0	0	0
										1	1	1	0	0	0	0	0	0	0	0	0	0	0	0	0	0
										1	1	1	1	0	0	0	0	0	0	0	0	0	0	0	0	0

**Table 5 : DDRAM data (character code) , CGRAM data / address map**

Note :

1. DDRAM data (character code) bit1 and bit2 are the same as CGRAM address bit4 and bit5.
2. CGRAM address bit0 to bit3 specify total 16 rows. Row16 is for cursor display. The data in row 16 will be logical OR to the cursor.
3. CGRAM data for each address is 16 bits.
4. DDRAM data to select CGRAM bit4 to bit15 must be "0". Bit0 and bit3 value are "don't care".

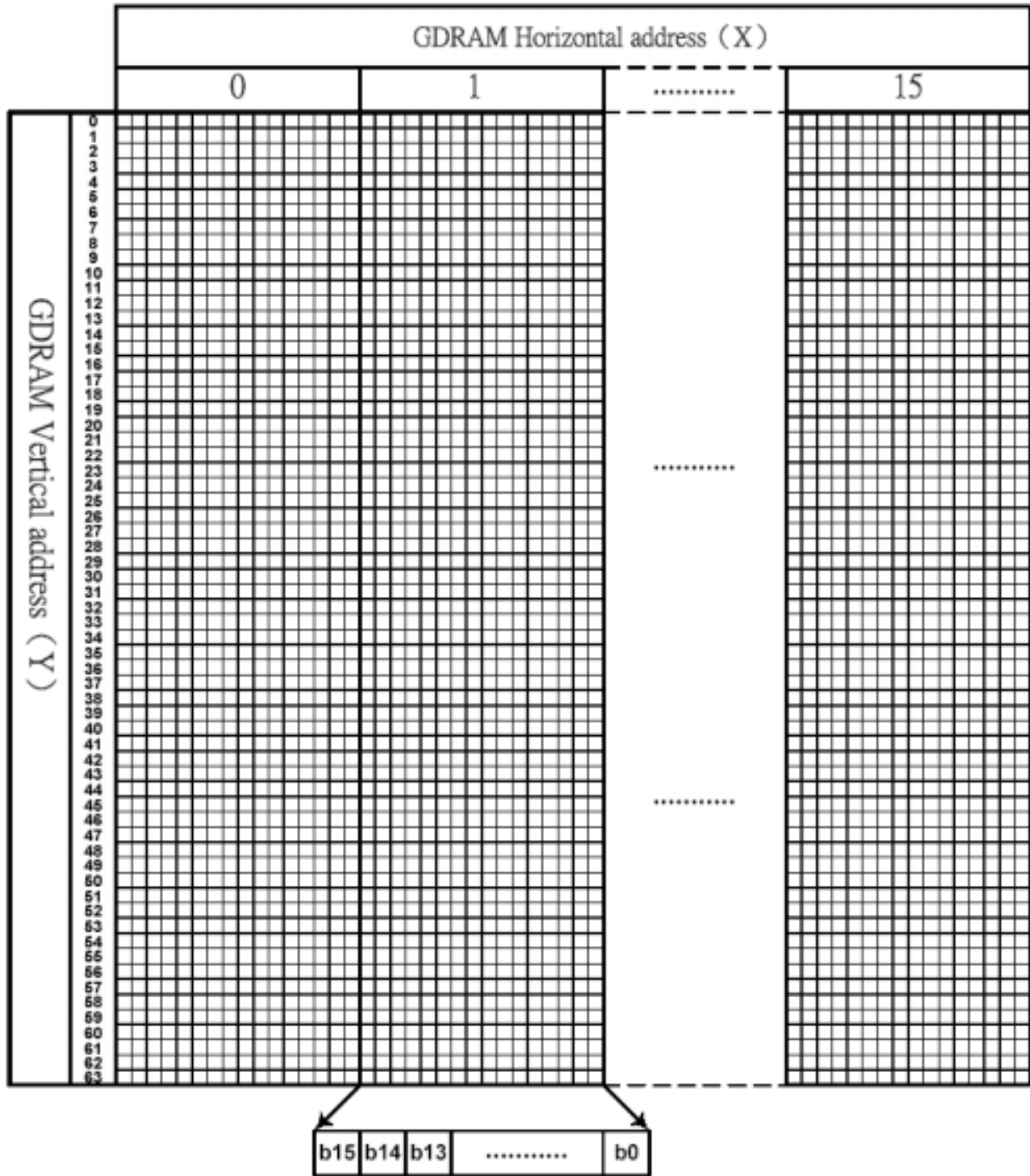

**Table 8 GDRAM display coordinates and corresponding address**

ICON RAM address Set SR "0", and then set IRAM address AC3....AC0				ICON RAM data															
				Higher byte								Lower byte							
AC3	AC2	AC1	AC0	D15	D14	D13	D12	D11	D10	D9	D8	D7	D6	D5	D4	D3	D2	D1	D0
0	0	0	0	SEG0	SEG1	SEG2	SEG3	SEG4	SEG5	SEG6	SEG7	SEG8	SEG9	SEG10	SEG11	SEG12	SEG13	SEG14	SEG15
0	0	0	1	SEG16	SEG17	SEG18	SEG19	SEG20	SEG21	SEG22	SEG23	SEG24	SEG25	SEG26	SEG27	SEG28	SEG29	SEG30	SEG31
0	0	1	0	SEG32	SEG33	SEG34	SEG35	SEG36	SEG37	SEG38	SEG39	SEG40	SEG41	SEG42	SEG43	SEG44	SEG45	SEG46	SEG47
0	0	1	1	SEG48	SEG49	SEG50	SEG51	SEG52	SEG53	SEG54	SEG55	SEG56	SEG57	SEG58	SEG59	SEG60	SEG61	SEG62	SEG63
0	1	0	0	SEG64	SEG65	SEG66	SEG67	SEG68	SEG69	SEG70	SEG71	SEG72	SEG73	SEG74	SEG75	SEG76	SEG77	SEG78	SEG79
0	1	0	1	SEG80	SEG81	SEG82	SEG83	SEG84	SEG85	SEG86	SEG87	SEG88	SEG89	SEG90	SEG91	SEG92	SEG93	SEG94	SEG95
0	1	1	0	SEG96	SEG97	SEG98	SEG99	SEG100	SEG101	SEG102	SEG103	SEG104	SEG105	SEG106	SEG107	SEG108	SEG109	SEG110	SEG111
0	1	1	1	SEG112	SEG113	SEG114	SEG115	SEG116	SEG117	SEG118	SEG119	SEG120	SEG121	SEG122	SEG123	SEG124	SEG125	SEG126	SEG127
1	0	0	0	SEG128	SEG129	SEG130	SEG131	SEG132	SEG133	SEG134	SEG135	SEG136	SEG137	SEG138	SEG139	SEG140	SEG141	SEG142	SEG143
1	0	0	1	SEG144	SEG145	SEG146	SEG147	SEG148	SEG149	SEG150	SEG151	SEG152	SEG153	SEG154	SEG155	SEG156	SEG157	SEG158	SEG159
1	0	1	0	SEG160	SEG161	SEG162	SEG163	SEG164	SEG165	SEG166	SEG167	SEG168	SEG169	SEG170	SEG171	SEG172	SEG173	SEG174	SEG175
1	0	1	1	SEG176	SEG177	SEG178	SEG179	SEG180	SEG181	SEG182	SEG183	SEG184	SEG185	SEG186	SEG187	SEG188	SEG189	SEG190	SEG191
1	1	0	0	SEG192	SEG193	SEG194	SEG195	SEG196	SEG197	SEG198	SEG199	SEG200	SEG201	SEG202	SEG203	SEG204	SEG205	SEG206	SEG207
1	1	0	1	SEG208	SEG209	SEG210	SEG211	SEG212	SEG213	SEG214	SEG215	SEG216	SEG217	SEG218	SEG219	SEG220	SEG221	SEG222	SEG223
1	1	1	0	SEG224	SEG225	SEG226	SEG227	SEG228	SEG229	SEG230	SEG231	SEG232	SEG233	SEG234	SEG235	SEG236	SEG237	SEG238	SEG239
1	1	1	1	---	---	---	---	---	---	---	---	---	---	---	---	---	---	---	---

Table 6 ICON RAM address, data and Segment pins

H/L	0	1	2	3	4	5	6	7	8	9	A	B	C	D	E	F
0		☺	☹	♥	♠	♣	♣	•	◐	◑	♂	♀	♫	♫	✂	✂
1	▶	◀	↑	!!	¶	§	-	‡	↑	↓	→	←	↵	↔	▲	▼
2		!	"	#	\$	%	&	'	(	)	*	+	,	-	.	/
3	0	1	2	3	4	5	6	7	8	9	:	;	<	=	>	?
4	@	A	B	C	D	E	F	G	H	I	J	K	L	M	N	O
5	P	Q	R	S	T	U	V	W	X	Y	Z	[	\	]	^	_
6	`	a	b	c	d	e	f	g	h	i	j	k	l	m	n	o
7	p	q	r	s	t	u	v	w	x	y	z	{	!	}	~	△

Table 7 16x8 half-height characters

11. Instruction description

Instruction set 1: (RE=0: basic instruction)

Ins	code										Description	Exec time (540KHZ)
	RS	RW	DB7	DB6	DB5	DB4	DB3	DB2	DB1	DB0		
CLEAR	0	0	0	0	0	0	0	0	0	1	Fill DDRAM with "20H", and set DDRAM address counter (AC) to "00H"	1.6 ms
HOME	0	0	0	0	0	0	0	0	0	1 X	Set DDRAM address counter (AC) to "00H", and put cursor to origin : the content of DDRAM are not changed	72us
ENTRY MODE	0	0	0	0	0	0	0	0	1	I/D S	Set cursor position and display shift when doing write or read operation	72us
DISPLAY ON/OFF	0	0	0	0	0	0	0	1	D	C B	D=1: display ON C=1: cursor ON B=1: blink ON	72 us
CURSOR DISPLAY CONTROL	0	0	0	0	0	1	S/C	R/L	X	X	Cursor position and display shift control : the content of DDRAM are not changed	72 us
FUNCTION SET	0	0	0	0	1	DL	X	0 RE	X	X	DL=1 8-BIT interface DL=0 4-BIT interface <u>RE=1: extended instruction</u> <u>RE=0: basic instruction</u>	72 us
SET CGRAM ADDR.	0	0	0	1	AC5	AC4	AC3	AC2	AC1	AC0	Set CGRAM address to address counter (AC) <u>Make sure that in extended instruction SR=0 (scroll or RAM address select)</u>	72 us
SET DDRAM ADDR.	0	0	1	0 AC6	AC5	AC4	AC3	AC2	AC1	AC0	Set DDRAM address to address counter (AC) AC6 is fixed to 0	72 us
READ BUSY FLAG (BF) & ADDR.	0	1	BF	AC6	AC5	AC4	AC3	AC2	AC1	AC0	Read busy flag (BF) for completion of internal operation, also Read out the value of address counter (AC)	0 us
WRITE RAM	1	0	D7	D6	D5	D4	D3	D2	D1	D0	Write data to internal RAM (DDRAM/CGRAM/IRAM/GDRAM)	72 us
READ RAM	1	1	D7	D6	D5	D4	D3	D2	D1	D0	Read data from internal RAM (DDRAM/CGRAM/IRAM/GDRAM)	72 us

**Instruction set 2: (RE=1: extended instruction)**

Inst.	code										description	Exec. time (540KHZ)	
	RS	RW	DB7	DB6	DB5	DB4	DB3	DB2	DB1	DB0			
STAND BY	0	0	0	0	0	0	0	0	0	1	Enter stand by mode, any other instruction can terminate (Com1..32 halted, only Com33 ICON can display)	72 us	
SCROLL or RAM ADDR. SELECT	0	0	0	0	0	0	0	0	0	1 SR	SR=1: enable vertical scroll position SR=0: enable IRAM address ( <u>extended instruction</u> ) SR=0: enable CGRAM address( <u>basic instruction</u> )	72 us	
REVERSE	0	0	0	0	0	0	0	1	R1	R0	Select 1 out of 4 line ( in DDRAM) and decide whether to reverse the display by toggling this instruction <b>R1,R0 initial value is 00</b>	72 us	
EXTENDED FUNCTION SET	0	0	0	0	1	DL	X	1	RE	G	0	DL=1 8-BIT interface DL=0 4-BIT interface <u>RE=1: extended instruction set</u> <u>RE=0: basic instruction set</u> G=1 :graphic display ON G=0 :graphic display OFF	72 us
SET IRAM or SCROLL ADDR	0	0	0	1	AC5	AC4	AC3	AC2	AC1	AC0	SR=1: AC5~AC0 the address of vertical scroll SR=0: AC3~AC0 the address of ICON RAM	72 us	
SET GRAPHIC RAM ADDR.	0	0	1	0	0	0	AC3	AC2	AC1	AC0	Set GDRAM address to address counter (AC) First set vertical address and the horizontal address by consecutive writing Vertical address range AC5...AC0 Horizontal address range AC3...AC0	72 us	

**Note :**

1. Make sure that ST7920 is not in busy state by reading the busy flag before sending instruction or data. If use delay loop instead please make sure the delay time is enough. Please refer to the instruction execution time.
2. "RE" is the selection bit of basic and extended instruction set. Each time when altering the value of RE it will remain. There is no need to set RE every time when using the same group of instruction set.

**Initial setting(Register flag) (RE=0: basic instruction)**

Inst.	code										Description
	RS	RW	DB7	DB6	DB5	DB4	DB3	DB2	DB1	DB0	
ENTRY MODE SET	0	0	0	0	0	0	0	1	I/D	S	Cursor move to right ,DDRAM address counter ( AC ) plus 1
										1 0	
DISPLAY STATUS	0	0	0	0	0	0	1	D	C	B	Display, cursor and blink ALL OFF
									0 0 0		
CURSOR DISPLAY SHIFT	0	0	0	0	0	1	S/C	R/L	X	X	No cursor or display shift operation
							X	X			
FUNCTION SET	0	0	0	0	1	DL	X	RE	X	X	8 BIT MPU interface , basic instruction set
						1		0			

**Initial setting(Register flag) (RE=1: extended instruction set)**

Inst.	code										description
	RS	RW	DB7	DB6	DB5	DB4	DB3	DB2	DB1	DB0	
SCROLL OR RAM ADDR. SELECT	0	0	0	0	0	0	0	0	1	SR	Allow IRAMaddress or set CGRAM address
										0	
REVERSE	0	0	0	0	0	0	0	1	R1	R0	Begin with normal and toggle to reverse
									0 0		
EXTENDED FUNCTION SET	0	0	0	0	1	DL	X	RE	G	0	Graphic display OFF
									0		

**12. QUALITY SPECIFICATIONS**

**12.1 Standard of the product appearance test**

Manner of appearance test: The inspection should be performed in using 20W x 2 fluorescent lamps. Distance between LCM and fluorescent lamps should be 100 cm or more. Distance between LCM and inspector eyes should be 30 cm or more.

Viewing direction for inspection is 45° from vertical against LCM.

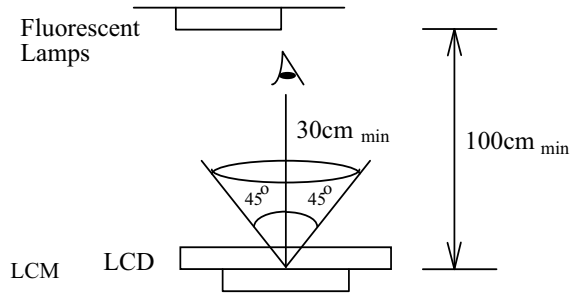

Definition of zone:

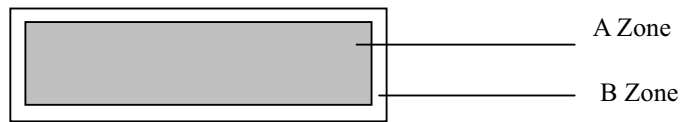

A Zone: Active display area (minimum viewing area).

B Zone: Non-active display area (outside viewing area).



**12.2 Specification of quality assurance**

AQL inspection standard

Sampling method: MIL-STD-105E, Level II, single sampling

Defect classification **(Note: \* is not including)**

Classify	Item		Note	AQL
Major	Display state	Short or open circuit	1	0.65
		LC leakage		
		Flickering		
		No display		
		Wrong viewing direction		
		Contrast defect (dim, ghost)	2	
	Back-light	1,8		
	Non-display	Flat cable or pin reverse	10	
Wrong or missing component		11		
Minor	Display state	Background color deviation	2	1.0
		Black spot and dust	3	
		Line defect, Scratch	4	
		Rainbow	5	
		Chip	6	
		Pin hole	7	
	Polarizer	Protruded	12	
		Bubble and foreign material	3	
	Soldering	Poor connection	9	
	Wire	Poor connection	10	
	TAB	Position, Bonding strength	13	

**Note on defect classification**

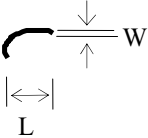
No.	Item	Criterion																				
1	Short or open circuit	Not allow																				
	LC leakage																					
	Flickering																					
	No display																					
	Wrong viewing direction																					
	Wrong Back-light																					
2	Contrast defect	Refer to approval sample																				
	Background color deviation																					
3	Point defect, Black spot, dust (including Polarizer)	 <table border="1" data-bbox="873 814 1279 1092"> <thead> <tr> <th>Point Size</th> <th>Acceptable Qty.</th> </tr> </thead> <tbody> <tr> <td><math>\phi \leq 0.10</math></td> <td>Disregard</td> </tr> <tr> <td><math>0.10 &lt; \phi \leq 0.20</math></td> <td>3</td> </tr> <tr> <td><math>0.20 &lt; \phi \leq 0.25</math></td> <td>2</td> </tr> <tr> <td><math>0.25 &lt; \phi \leq 0.30</math></td> <td>1</td> </tr> <tr> <td><math>\phi &gt; 0.30</math></td> <td>0</td> </tr> </tbody> </table> <p style="text-align: right;">Unit : mm</p>	Point Size	Acceptable Qty.	$\phi \leq 0.10$	Disregard	$0.10 < \phi \leq 0.20$	3	$0.20 < \phi \leq 0.25$	2	$0.25 < \phi \leq 0.30$	1	$\phi > 0.30$	0								
	Point Size		Acceptable Qty.																			
$\phi \leq 0.10$	Disregard																					
$0.10 < \phi \leq 0.20$	3																					
$0.20 < \phi \leq 0.25$	2																					
$0.25 < \phi \leq 0.30$	1																					
$\phi > 0.30$	0																					
	$\phi = (X+Y)/2$																					
4	Line defect, Scratch	 <table border="1" data-bbox="808 1218 1318 1459"> <thead> <tr> <th colspan="2">Line</th> <th>Acceptable Qty.</th> </tr> <tr> <th>L</th> <th>W</th> <th></th> </tr> </thead> <tbody> <tr> <td>---</td> <td><math>0.015 &lt; W</math></td> <td>Disregard</td> </tr> <tr> <td>3.0 L</td> <td><math>0.03 &lt; W</math></td> <td rowspan="2">2</td> </tr> <tr> <td>2.0 L</td> <td><math>0.05 &lt; W</math></td> </tr> <tr> <td>1.0 L</td> <td><math>0.1 &gt; W</math></td> <td>1</td> </tr> <tr> <td>---</td> <td><math>0.05 &lt; W</math></td> <td>Applied as point defect</td> </tr> </tbody> </table> <p style="text-align: right;">Unit: mm</p>	Line		Acceptable Qty.	L	W		---	$0.015 < W$	Disregard	3.0 L	$0.03 < W$	2	2.0 L	$0.05 < W$	1.0 L	$0.1 > W$	1	---	$0.05 < W$	Applied as point defect
	Line		Acceptable Qty.																			
L	W																					
---	$0.015 < W$	Disregard																				
3.0 L	$0.03 < W$	2																				
2.0 L	$0.05 < W$																					
1.0 L	$0.1 > W$	1																				
---	$0.05 < W$	Applied as point defect																				
5	Rainbow	Not more than two color changes across the viewing area.																				

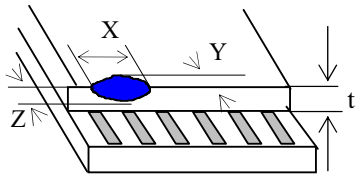
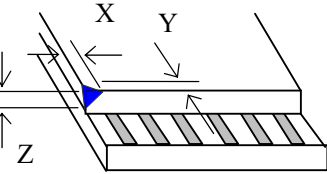
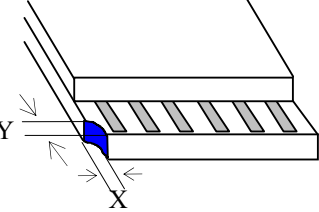
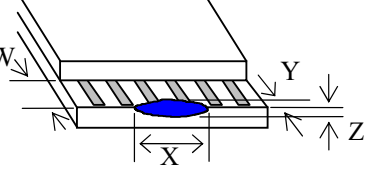
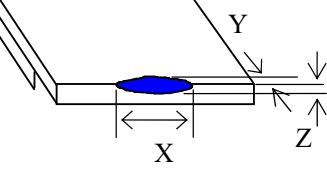
No	Item	Criterion																																	
6	<p>Chip</p> <p>Remark:</p> <p>X: Length direction</p> <p>Y: Short direction</p> <p>Z: Thickness direction</p> <p>t: Glass thickness</p> <p>W: Terminal Width</p>	 <p>Acceptable criterion</p> <table border="1" data-bbox="938 275 1300 344"> <thead> <tr> <th>X</th> <th>Y</th> <th>Z</th> </tr> </thead> <tbody> <tr> <td>2</td> <td>0.5mm</td> <td>t/2</td> </tr> </tbody> </table>  <p>Acceptable criterion</p> <table border="1" data-bbox="927 569 1305 638"> <thead> <tr> <th>X</th> <th>Y</th> <th>Z</th> </tr> </thead> <tbody> <tr> <td>2</td> <td>0.5mm</td> <td>t</td> </tr> </tbody> </table>  <p>Acceptable criterion</p> <table border="1" data-bbox="943 842 1305 947"> <thead> <tr> <th>X</th> <th>Y</th> <th>Z</th> </tr> </thead> <tbody> <tr> <td>3</td> <td>2</td> <td>t</td> </tr> <tr> <td colspan="2">shall not reach to ITO</td> <td></td> </tr> </tbody> </table>  <p>Acceptable criterion</p> <table border="1" data-bbox="927 1192 1305 1262"> <thead> <tr> <th>X</th> <th>Y</th> <th>Z</th> </tr> </thead> <tbody> <tr> <td>Disregard</td> <td>0.2</td> <td>t</td> </tr> </tbody> </table>  <p>Acceptable criterion</p> <table border="1" data-bbox="927 1461 1276 1530"> <thead> <tr> <th>X</th> <th>Y</th> <th>Z</th> </tr> </thead> <tbody> <tr> <td>5</td> <td>2</td> <td>t/3</td> </tr> </tbody> </table>	X	Y	Z	2	0.5mm	t/2	X	Y	Z	2	0.5mm	t	X	Y	Z	3	2	t	shall not reach to ITO			X	Y	Z	Disregard	0.2	t	X	Y	Z	5	2	t/3
X	Y	Z																																	
2	0.5mm	t/2																																	
X	Y	Z																																	
2	0.5mm	t																																	
X	Y	Z																																	
3	2	t																																	
shall not reach to ITO																																			
X	Y	Z																																	
Disregard	0.2	t																																	
X	Y	Z																																	
5	2	t/3																																	

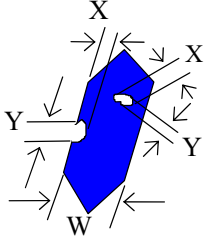
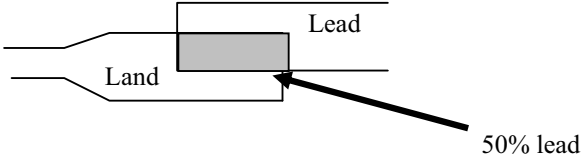
No.	Item	Criterion								
7	Segment pattern $W = \text{Segment width}$ $\phi = (X+Y)/2$	(1) Pin hole $\phi < 0.10\text{mm}$ is acceptable.  <table border="1" data-bbox="865 405 1294 564"> <thead> <tr> <th>Point Size</th> <th>Acceptable Qty</th> </tr> </thead> <tbody> <tr> <td><math>\phi \leq 1/4W</math></td> <td>Disregard</td> </tr> <tr> <td><math>1/4W &lt; \phi \leq 1/2W</math></td> <td>1</td> </tr> <tr> <td><math>\phi &gt; 1/2W</math></td> <td>0</td> </tr> </tbody> </table> <p style="text-align: right;">Unit: mm</p>	Point Size	Acceptable Qty	$\phi \leq 1/4W$	Disregard	$1/4W < \phi \leq 1/2W$	1	$\phi > 1/2W$	0
Point Size	Acceptable Qty									
$\phi \leq 1/4W$	Disregard									
$1/4W < \phi \leq 1/2W$	1									
$\phi > 1/2W$	0									
8	Back-light	(1) The color of backlight should correspond its specification. (2) Not allow flickering								
9	Soldering	(1) Not allow heavy dirty and solder ball on PCB. (The size of dirty refer to point and dust defect) (2) Over 50% of lead should be soldered on Land. 								
10	Wire	(1) Copper wire should not be rusted (2) Not allow crack on copper wire connection. (3) Not allow reversing the position of the flat cable. (4) Not allow exposed copper wire inside the flat cable.								
11*	PCB	(1) Not allow screw rust or damage. (2) Not allow missing or wrong putting of component.								

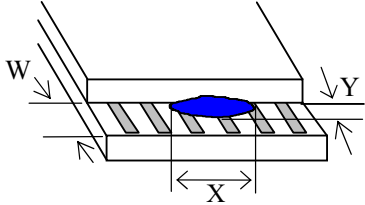
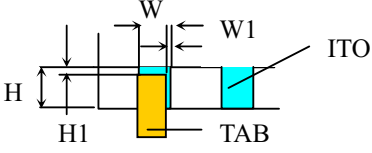
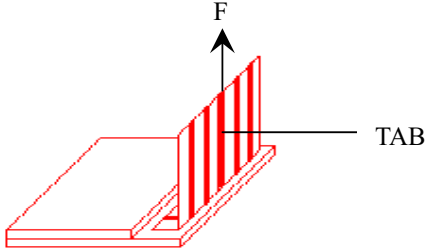
No	Item	Criterion				
12	Protruded W: Terminal Width	 <p>Acceptable criteria:  <math>Y \leq 0.4</math></p>				
13	TAB	<p>1. Position</p>  <table border="1" data-bbox="1112 583 1328 709"> <tr> <td>W1</td> <td>1/3W</td> </tr> <tr> <td>H1</td> <td>1/3H</td> </tr> </table> <p>2 TAB bonding strength test</p>  <p> <math>P (=F/TAB \text{ bonding width})</math> 650gf/cm ,(speed rate: 1mm/min)                      5pcs per SOA (shipment)                 </p>	W1	1/3W	H1	1/3H
W1	1/3W					
H1	1/3H					
14	Total no. of acceptable Defect	<p>A. Zone</p> <p>Maximum 2 minor non-conformities per one unit.                      Defect distance: each point to be separated over 10mm</p> <p>B. Zone</p> <p>It is acceptable when it is no trouble for quality and assembly in customer's end product.</p>				

### 12.3 Reliability of LCM

Reliability test condition:

Item	Condition	Time (hrs)	Assessment
High temp. Storage	80°C	48	No abnormalities in functions and appearance
High temp. Operating	70°C	48	
Low temp. Storage	-30°C	48	
Low temp. Operating	-20°C	48	
Humidity	40°C/ 90%RH	48	
Temp. Cycle	0°C ← 25°C → 50°C (30 min ← 5 min → 30min)	10cycles	

Recovery time should be 24 hours minimum. Moreover, functions, performance and appearance shall be free from remarkable deterioration within 50,000 hours under ordinary operating and storage conditions room temperature (20±8°C), normal humidity (below 65% RH), and in the area not exposed to direct sun light.

### 12.4 Precaution for using LCD/LCM

LCD/LCM is assembled and adjusted with a high degree of precision. Do not attempt to make any alteration or modification. The followings should be noted.

#### General Precautions:

1. LCD panel is made of glass. Avoid excessive mechanical shock or applying strong pressure onto the surface of display area.
2. The polarizer used on the display surface is easily scratched and damaged. Extreme care should be taken when handling. To clean dust or dirt off the display surface, wipe gently with cotton, or other soft material soaked with isopropyl alcohol, ethyl alcohol or trichlorotrifluoroethane, do not use water, ketone or aromatics and never scrub hard.
3. Do not tamper in any way with the tabs on the metal frame.
4. Do not make any modification on the PCB without consulting Newhaven Display
5. When mounting a LCM, make sure that the PCB is not under any stress such as bending or twisting. Elastomer contacts are very delicate and missing pixels could result from slight dislocation of any of the elements.
6. Avoid pressing on the metal bezel, otherwise the elastomer connector could be deformed and lose contact, resulting in missing pixels and also cause rainbow on the display.
7. Be careful not to touch or swallow liquid crystal that might leak from a damaged cell. Any liquid crystal adheres to skin or clothes, wash it off immediately with soap and water.

#### Static Electricity Precautions:

1. CMOS-LSI is used for the module circuit; therefore operators should be grounded whenever he/she comes into contact with the module.
2. Do not touch any of the conductive parts such as the LSI pads; the copper leads on the PCB and the interface terminals with any parts of the human body.
3. Do not touch the connection terminals of the display with bare hand; it will cause disconnection or

- defective insulation of terminals.
4. The modules should be kept in anti-static bags or other containers resistant to static for storage.
  5. Only properly grounded soldering irons should be used.
  6. If an electric screwdriver is used, it should be grounded and shielded to prevent sparks.
  7. The normal static prevention measures should be observed for work clothes and working benches.
  8. Since dry air is inductive to static, a relative humidity of 50-60% is recommended.

**Soldering Precautions:**

1. Soldering should be performed only on the I/O terminals.
2. Use soldering irons with proper grounding and no leakage.
3. Soldering temperature:  $280^{\circ}\text{C} \pm 10^{\circ}\text{C}$
4. Soldering time: 3 to 4 second.
5. Use eutectic solder with resin flux filling.
6. If flux is used, the LCD surface should be protected to avoid spattering flux.
7. Flux residue should be removed.

**Operation Precautions:**

1. The viewing angle can be adjusted by varying the LCD driving voltage  $V_o$ .
2. Since applied DC voltage causes electro-chemical reactions, which deteriorate the display, the applied pulse waveform should be a symmetric waveform such that no DC component remains. Be sure to use the specified operating voltage.
3. Driving voltage should be kept within specified range; excess voltage will shorten display life.
4. Response time increases with decrease in temperature.
5. Display color may be affected at temperatures above its operational range.
6. Keep the temperature within the specified range usage and storage. Excessive temperature and humidity could cause polarization degradation, polarizer peel-off or generate bubbles.
7. For long-term storage over  $40^{\circ}\text{C}$  is required, the relative humidity should be kept below 60%, and avoid direct sunlight.

**Limited Warranty**

Newhaven Displays and modules are not consumer products, but may be incorporated by Newhaven Display's customers into consumer products or components thereof, Newhaven Display does not warrant that its LCDs and components are fit for any such particular purpose.

1. The liability of Newhaven Display is limited to repair or replacement on the terms set forth below. Newhaven Display will not be responsible for any subsequent or consequential events or injury or damage to any personnel or user including third party personnel and/or user. Unless otherwise agreed in writing between Newhaven Display and the customer, Newhaven Display will only replace or repair any of its LCD which is found defective electrically or visually when inspected in accordance with Newhaven Display general LCD inspection standard. (Copies available on request)
2. No warranty can be granted if any of the precautions state in handling liquid crystal display above has been disregarded. Broken glass, scratches on polarizer mechanical damages as well as defects that are caused accelerated environment tests are excluded from warranty.
3. In returning the LCD/LCM, they must be properly packaged; there should be detailed description of the failures or defect.