

NHD-0220DZ-FSW-FBW

Character Liquid Crystal Display Module

NHD-	Newhaven Display
0220-	2 lines x 20 characters
DZ-	Model
F-	Transflective
SW-	Side White LED Backlight
F-	FSTN (+)
B-	6:00 view
W-	Wide Temperature (-20°C~+70°C)
	RoHS Compliant

Newhaven Display International, Inc.

2511 Technology Drive, Suite 101

Elgin IL, 60124

Ph: 847-844-8795

Fax: 847-844-8796

www.newhavendisplay.com

nhtech@newhavendisplay.com

nhsales@newhavendisplay.com

Document Revision History

Revision	Date	Description	Changed by
0	4/2/2009	Initial Release	-
1	2/3/2010	User Guide Reformat	BE
2	6/3/2010	Character code updated	BE
3	1/7/2011	Alternate controller information updated	AK

Functions and Features

- 2 lines x 20 characters
- Built-in controller (SPLC780D or ST7066U)
- +5.0V Power Supply
- 1/16 duty, 1/5 bias
- RoHS compliant

Mechanical Drawing

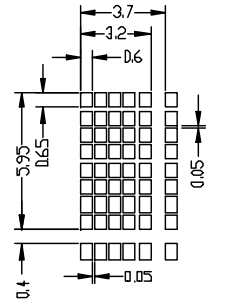
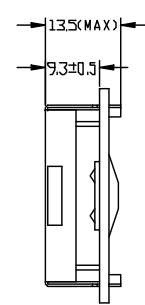
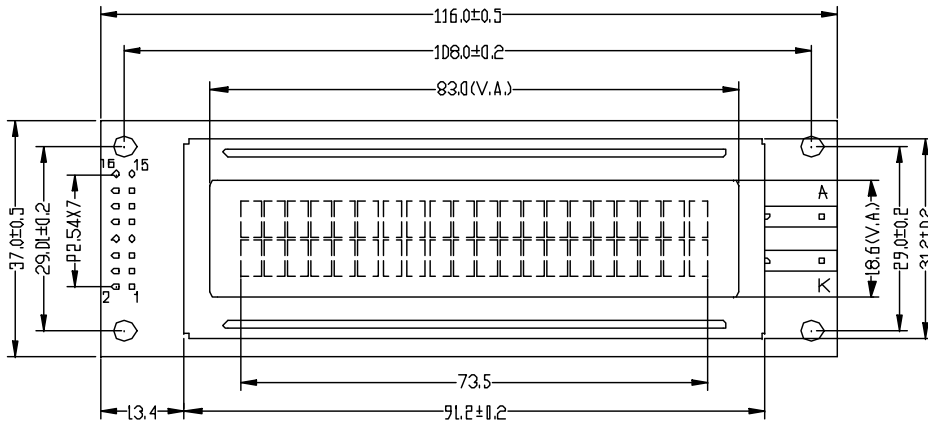

LED BKL

Display Pattern

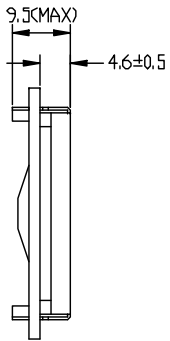

without BKL

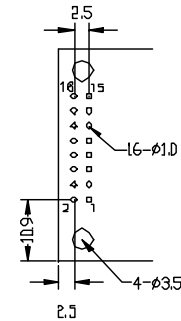
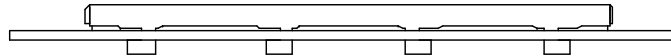

- Features:
1. 2-line x 20 character display; 5 x 8 dots with cursor
 2. Built-in controller (SPLC780D or ST7066U)
 3. +5V power supply
 4. 1/16 duty cycle; 1/5 bias
 5. FSTN; Positive; Transflective
 6. Backlight: Side White

Pin	Symbol
1	VSS
2	VDD
3	V0
4	RS
5	R/W
6	E
7	DB0
8	DB1
9	DB2
10	DB3
11	DB4
12	DB5
13	DB6
14	DB7
15	LED+
16	LED-

Newhaven Display

Part No. NHD-0220DZ-FSW-FBW

Pin Description and Wiring Diagram

Pin No.	Symbol	External Connection	Function Description
1	VSS	Power Supply	Ground
2	VDD	Power Supply	Supply Voltage for logic (+5.0V)
3	VO	Adj Power Supply	Power supply for contrast (approx. 0.4V)
4	RS	MPU	Register select signal. RS=0: Command, RS=1: Data
5	R/W	MPU	Read/Write select signal, R/W=1: Read R/W: =0: Write
6	E	MPU	Operation enable signal. Falling edge triggered.
7-10	DB0 – DB3	MPU	Four low order bi-directional three-state data bus lines. These four are not used during 4-bit operation.
11-14	DB4 – DB7	MPU	Four high order bi-directional three-state data bus lines.
15	LED+	Power Supply	Power supply for LED Backlight (+5.0V via on-board resistor)
16	LED-	Power Supply	Ground for Backlight

Recommended LCD connector: 2.54mm pitch pins

Backlight connector: --- **Mates with:** ---

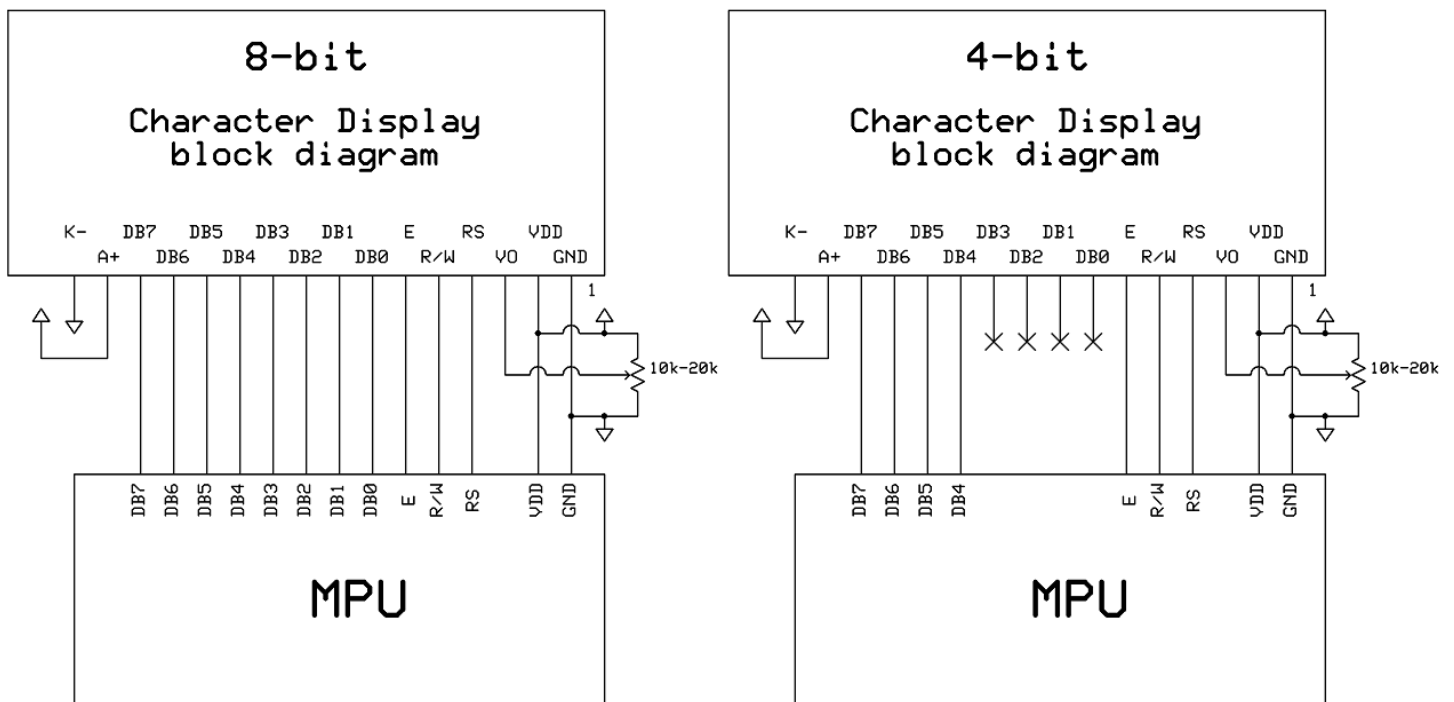

Electrical Characteristics

Item	Symbol	Condition	Min.	Typ.	Max.	Unit
Operating Temperature Range	Top	Absolute Max	-20	-	+70	°C
Storage Temperature Range	Tst	Absolute Max	-30	-	+80	°C
Supply Voltage	VDD		4.7	5.0	5.5	V
Supply Current	IDD	Ta=25°C, VDD=5.0V	-	1.5	2.5	mA
Supply for LCD (contrast)	VDD-V0	Ta=25°C	-	4.6	-	V
"H" Level input	Vih		2.2	-	VDD	V
"L" Level input	Vil		0	-	0.6	V
"H" Level output	Voh		2.4	-	-	V
"L" Level output	Vol		-	-	0.4	V
Backlight Supply Voltage	Vled	-	-	5.0	-	V
Backlight Supply Current	Iled	Vled=5.0V	-	25	-	mA

Optical Characteristics

Item	Symbol	Condition	Min.	Typ.	Max.	Unit
Viewing Angle – Vertical (top)	AV	Cr ≥ 3	-	20	-	°
Viewing Angle – Vertical (bottom)	AV	Cr ≥ 3	-	50	-	°
Viewing Angle – Horizontal (left)	AH	Cr ≥ 3	-	30	-	°
Viewing Angle – Horizontal (right)	AH	Cr ≥ 3	-	30	-	°
Contrast Ratio	Cr		3	5	-	-
Response Time (rise)	Tr	-	-	150	250	ms
Response Time (fall)	Tf	-	-	150	250	ms

Controller Information

Built-in SPLC780D. Download specification at http://www.newhavendisplay.com/app_notes/SPLC780D.pdf

Built-in ST7066U. Download specification at http://www.newhavendisplay.com/app_notes/ST7066U.pdf

Display character address code

1	2	3	4	5	6	7	8	9	10	11	12	13	14	15	16	17	18	19	20
00	01	02	03	04	05	06	07	08	09	0A	0B	0C	0D	0E	0F	10	11	12	13
40	41	42	43	44	45	46	47	48	49	4A	4B	4C	4D	4E	4F	50	51	52	53

Built-in Font Table

Lower 4 Bits \ Upper 4 Bits	0000	0001	0010	0011	0100	0101	0110	0111	1000	1001	1010	1011	1100	1101	1110	1111
xxxx0000	CG RAM (1)			0	a	P	`	P				-	夕	三	α	P
xxxx0001	(2)		!	1	A	Q	a	q			。	ア	チ	△	ä	q
xxxx0010	(3)		"	2	B	R	b	r			「	イ	ツ	×	ß	θ
xxxx0011	(4)		#	3	C	S	c	s			」	ウ	テ	モ	ε	ø
xxxx0100	(5)		\$	4	D	T	d	t			、	エ	ト	ト	μ	Ω
xxxx0101	(6)		%	5	E	U	e	u			・	オ	ナ	1	ø	ü
xxxx0110	(7)		&	6	F	V	f	v			ヲ	カ	ニ	ヨ	ρ	Σ
xxxx0111	(8)		'	7	G	W	g	w			ヲ	キ	ヌ	ラ	g	π
xxxx1000	(1)		(8	H	X	h	x			イ	ク	ネ	リ	γ	Σ
xxxx1001	(2))	9	I	Y	i	y			ウ	ケ	ル	ル	ˆ	γ
xxxx1010	(3)		*	:	J	Z	j	z			エ	コ	ハ	レ	j	κ
xxxx1011	(4)		+	;	K	[k	[オ	サ	ヒ	ロ	*	κ
xxxx1100	(5)		,	<	L	¥	l	l			カ	シ	フ	ワ	φ	π
xxxx1101	(6)		-	=	M]	m)			ユ	ス	ハ	ン	モ	÷
xxxx1110	(7)		.	>	N	^	n	→			ヨ	セ	ホ	°	π	
xxxx1111	(8)		/	?	O	_	o	€			ッ	リ	マ	°	ö	■

Example Initialization Program

8-bit Initialization:

```

/*****/
void command(char i)
{
    P1 = i;                //put data on output Port
    D_I = 0;              //D/I=LOW : send instruction
    R_W = 0;              //R/W=LOW : Write
    E = 1;
    Delay(1);             //enable pulse width >= 300ns
    E = 0;                //Clock enable: falling edge
}
/*****/
void write(char i)
{
    P1 = i;                //put data on output Port
    D_I = 1;              //D/I=LOW : send data
    R_W = 0;              //R/W=LOW : Write
    E = 1;
    Delay(1);             //enable pulse width >= 300ns
    E = 0;                //Clock enable: falling edge
}
/*****/
void init()
{
    E = 0;
    Delay(100);           //Wait >15 msec after power is applied
    command(0x30);        //command 0x30 = Wake up
    Delay(30);            //must wait 5ms, busy flag not available
    command(0x30);        //command 0x30 = Wake up #2
    Delay(10);            //must wait 160us, busy flag not available
    command(0x30);        //command 0x30 = Wake up #3
    Delay(10);            //must wait 160us, busy flag not available
    command(0x38);        //Function set: 8-bit/2-line
    command(0x10);        //Set cursor
    command(0x0c);        //Display ON; Cursor ON
    command(0x06);        //Entry mode set
}
/*****/
```

```

4-bit Initialization:
/*****/
void command(char i)
{
    P1 = i;                //put data on output Port
    D_I =0;                //D/I=LOW : send instruction
    R_W =0;                //R/W=LOW : Write
    Nybble();              //Send lower 4 bits
    i = i<<4;              //Shift over by 4 bits
    P1 = i;                //put data on output Port
    Nybble();              //Send upper 4 bits
}
/*****/
void write(char i)
{
    P1 = i;                //put data on output Port
    D_I =1;                //D/I=HIGH : send data
    R_W =0;                //R/W=LOW : Write
    Nybble();              //Clock lower 4 bits
    i = i<<4;              //Shift over by 4 bits
    P1 = i;                //put data on output Port
    Nybble();              //Clock upper 4 bits
}
/*****/
void Nybble()
{
    E = 1;
    Delay(1);              //enable pulse width >= 300ns
    E = 0;                 //Clock enable: falling edge
}
/*****/
void init()
{
    P1 = 0;
    P3 = 0;
    Delay(100);            //Wait >15 msec after power is applied
    P1 = 0x30;             //put 0x30 on the output port
    Delay(30);             //must wait 5ms, busy flag not available
    Nybble();              //command 0x30 = Wake up
    Delay(10);             //must wait 160us, busy flag not available
    Nybble();              //command 0x30 = Wake up #2
    Delay(10);             //must wait 160us, busy flag not available
    Nybble();              //command 0x30 = Wake up #3
    Delay(10);             //can check busy flag now instead of delay
    P1= 0x20;              //put 0x20 on the output port
    Nybble();              //Function set: 4-bit interface
    command(0x28);         //Function set: 4-bit/2-line
    command(0x10);         //Set cursor
    command(0x0F);         //Display ON; Blinking cursor
    command(0x06);         //Entry Mode set
}
/*****/

```

Quality Information

Test Item	Content of Test	Test Condition	Note
High Temperature storage	Endurance test applying the high storage temperature for a long time.	+80°C , 48hrs	2
Low Temperature storage	Endurance test applying the low storage temperature for a long time.	-30°C , 48hrs	1,2
High Temperature Operation	Endurance test applying the electric stress (voltage & current) and the high thermal stress for a long time.	+70°C 48hrs	2
Low Temperature Operation	Endurance test applying the electric stress (voltage & current) and the low thermal stress for a long time.	-20°C , 48hrs	1,2
High Temperature / Humidity Operation	Endurance test applying the electric stress (voltage & current) and the high thermal with high humidity stress for a long time.	+40°C , 90% RH , 48hrs	1,2
Thermal Shock resistance	Endurance test applying the electric stress (voltage & current) during a cycle of low and high thermal stress.	0°C,30min -> 25°C,5min -> 50°C,30min = 1 cycle 10 cycles	
Vibration test	Endurance test applying vibration to simulate transportation and use.	10-55Hz , 15mm amplitude. 60 sec in each of 3 directions X,Y,Z For 15 minutes	3
Static electricity test	Endurance test applying electric static discharge.	VS=800V, RS=1.5kΩ, CS=100pF One time	

Note 1: No condensation to be observed.

Note 2: Conducted after 4 hours of storage at 25°C, 0%RH.

Note 3: Test performed on product itself, not inside a container.

Precautions for using LCDs/LCMs

See Precautions at www.newhavendisplay.com/specs/precautions.pdf

Warranty Information and Terms & Conditions

http://www.newhavendisplay.com/index.php?main_page=terms