

New Models with Blanking Function Added to the Series

- Single-color (red or green) and two-color (red or green selectable) displays with a character height of 14 mm are available for a variety of applications and locations.
- Miniature design with a 43-mm depth is perfect for saving space in equipment and devices.
- Wide-range power supply from 12 to 24 VDC.
- Negative sign (–) display with signal codes is possible for Decimal-display Models.
- Models with zero suppression function available.



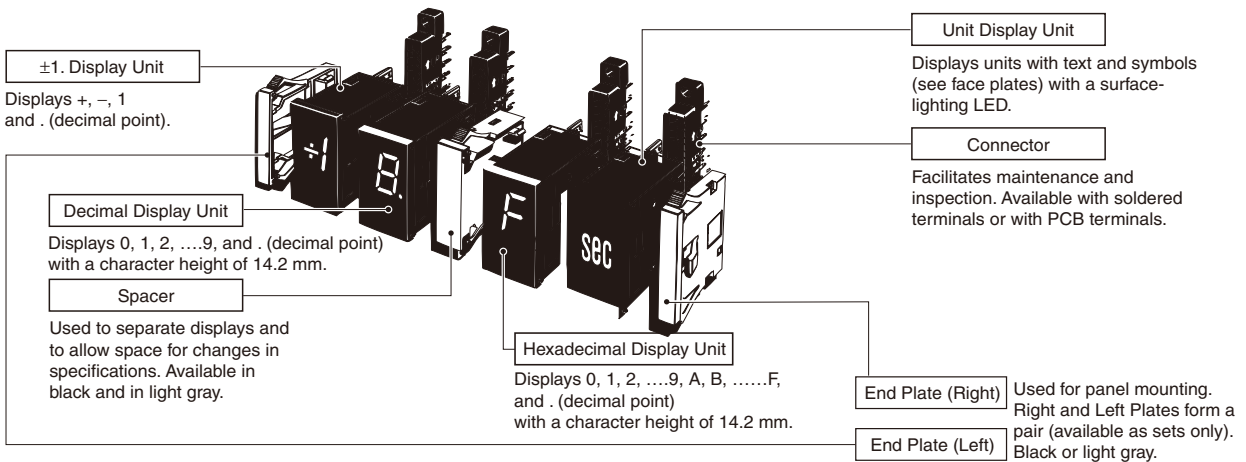

Model Configuration

■ Unit Configuration



Ordering Information

List of Models

Display contents	Display color	Type	Model		
			Model with Zero Suppression (See note 1.)	Model with Blanking (See note 2.)	
±1 	Red	Positive	---	M7E-01BRP2	
		Negative	---	M7E-01BRN2	
		Dynamic output	---	M7E-01BRD2	
	Green	Positive	---	M7E-01BGP2	
		Negative	---	M7E-01BGN2	
		Dynamic output	---	M7E-01BGD2	
Decimal 	Red	Positive	M7E-01DRP2	M7E-01DRP2-B	
		Negative	M7E-01DRN2	M7E-01DRN2-B	
		Dynamic output	M7E-01DRD2	M7E-01DRD2-B	
	Green	Positive	M7E-01DGP2	M7E-01DGP2-B	
		Negative	M7E-01DGN2	M7E-01DGN2-B	
		Dynamic output	M7E-01DGD2	M7E-01DGD2-B	
	Red/green (two colors)	Negative	M7E-01DRGN2	M7E-01DRGN2-B	
		Hexadecimal 	Positive	M7E-01HRP2	M7E-01HRP2-B
			Negative	M7E-01HRN2	M7E-01HRN2-B
Positive	M7E-01HGP2		M7E-01HGP2-B		
	Negative	M7E-01HGN2	M7E-01HGN2-B		

Display contents	Display color	Logic	Model
Unit 	Red	---	M7E-01UR2-□ (See note 3.)
	Green	---	M7E-01UG2-□ (See note 3.)

- Note:**
- Models with zero suppression are blank only when the display is $\bar{0}$ and the decimal is OFF by wiring as shown on page 12.
 - Models with blanking enable turning OFF a user-specified display ($\bar{0}$ to $\bar{9}$, \bar{A} to \bar{F}) by inputting a signal to the blank input terminal.
 - The symbol in the box (□) indicates the code for the display contents. Refer to page 13.

Accessories (Order Separately)

End Plate

Case color	Item	Model
Light gray		M7E-012M
Black		M7E-012M-1

Note: The Right and Left Plates form a pair.

Spacer

Case color	Item	Model
Light gray		M7E-012PA
Black		M7E-012PA-1

Connectable PLCs

Display contents	M7E model Type	PLC output method		
		Static output		Dynamic output
		PNP output	NPN output	
±1, decimal	Positive	○	△	△
	Negative	×	○	×
	Dynamic output	×	×	○
Hexa-decimal	Positive	○	△	△
	Negative	×	○	×
Unit	---	○ (only voltage imposed)		

○: Connectable

×: Not connectable

△: Connectable (See note.)

Note: Connectable but an external resistor is required and only 24 VDC must be supplied.

Refer to *External Connections* on page 9 and 10 for details.

Connector

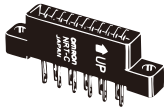
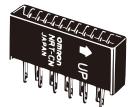
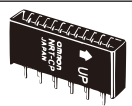
Terminal	Model
Solder terminal 	NRT-C
Solder terminal 	NRT-CN
PCB terminal 	NRT-CP

Mother Board

Type	Number of digits	Model
Static	4	M7E-01MB4-S2
Static	3	M7E-01MB3-S2
Static	2	M7E-01MB2-S2

Note: Refer to *M7E Mother Board for Display Units (Character Height: 14 mm)* for details.

Specifications

■ Ratings

Rated power supply		Wide range from 12 to 24 VDC
Allowable voltage fluctuation range		90% to 110% of rated voltage
Current consumption (per Display Unit)		Red LED: 35 mA max. at 24 VDC 60 mA max. at 12 VDC Green LED: 40 mA max. at 24 VDC 75 mA max. at 12 VDC Red/green LED: 45 mA max. at 24 VDC 90 mA max. at 12 VDC
Input level	Positive logic	High: 9.6 V to power supply voltage Low: 0 to 3 V
	Negative logic	High: 4 V to power supply voltage Low: 0 to 1.5 V
	Dynamic output	High: 4 V to power supply voltage Low: 0 to 1.5 V
Ambient temperature		Operating: -10°C to 55°C (with no icing) Storage: -25°C to 70°C (with no icing)
Ambient humidity		Operating: 35% to 85% (with no condensation)

■ Characteristics

Insulation resistance	100 MΩ min. at 500 VDC (between each terminal and mounting panel)
Dielectric strength	500 VAC at 50/60 Hz for 1 minute (between each terminal and mounting panel)
Noise immunity (See note 2.)	Power terminal: ±500 V Input terminal: ±500 V (normal mode) ±1,500 V (common mode)
Vibration resistance	Destruction: 10 to 55 Hz, 0.75-mm double amplitude
Shock resistance	Destruction: 300 m/s ²
Degree of protection	IEC IP40 (portion on panel surface)
Compatible connector	OMRON NRT-C/NRT-CN/NRT-CP

Note: 1. The above values are initial values.

2. Impulse conditions

Rise time: 1 ns + 10% max.

Pulse width: 100 ms, 1 μs

Polarity: Positive, negative, asynchronous to power frequency, 100-Hz repeat frequency.

Installation

■ Terminal Arrangements and Functions

Terminal Arrangement

Note: The circled numbers are the connector pin numbers (NRT-□).

±1. Display Unit

M7E-01B□□2

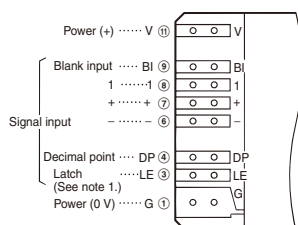

Decimal/Hexadecimal Display Unit (Single Color)

Models with Zero Suppression

M7E-01D□□2/M7E-01H□□2

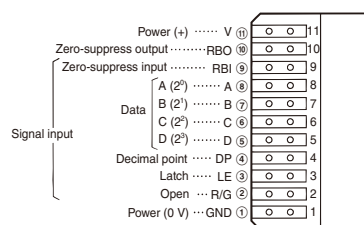

Models with Blanking

M7E-01D□□2-B/M7E-01H□□2-B

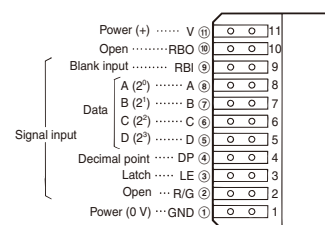

Unit Display Unit

M7E-01U□□2-□

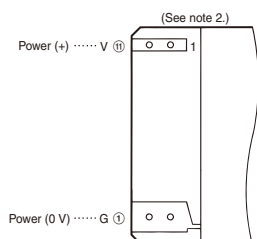

Decimal Display Unit (Two Colors)

Models with Zero Suppression

M7E-01DRGN2

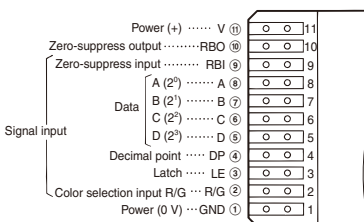

Models with Blanking

M7E-01DRGN2-B

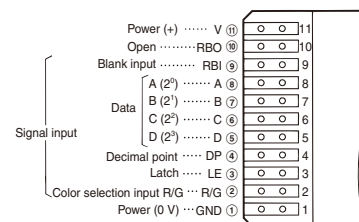

Note: 1. The latch terminal on ±1. Display Units is provided only on Dynamic Output Models.

2. The terminal numbers of the Unit Display Unit are different from the terminal numbers of the connector.

Terminal Functions

Terminal symbol	Name	Function		
		Decimal/Hexadecimal Display Unit		± Display Unit
		Models with Zero Suppression	Models with Blanking	
V	Power supply	Positive power supply input terminal		
RBO	Control output	Zero-suppress output (See note 1.)	---	---
RBI	Control input	Zero-suppress output (See note 1.)	Blanking input (Turns OFF all the displays including decimal point.)	---
BI	Control input	---	---	Blanking input (Turns OFF all the displays including decimal point.)
A B C D	Data inputs	Applicable to Decimal/Hexadecimal Display Unit •Displays a digit or symbol corresponding to the value of the binary code signal. •Decimal display uses 0 to 9; nothing will be displayed for higher values.		---
1 + -	Data inputs	---	---	Applicable to ±1. Display Unit only For each input terminal, the input of a signal causes a display to light.
DP	Data inputs	The decimal point lights.		
LE	Control input	Latch input The immediately preceding display condition is retained.		
R/G	Control input	Color selection input (See note 2.) Set low for green display and high for red display.		---
G	Power supply	0-V power-supply (ground) input terminal (GND)		

- Note:** 1. Refer to the input code table for RBO and RBI control.
2. Applicable to the M7E-01DRGN2 and -01DRGN2-B only.

Input Codes

Models with Positive or Negative Logic

±1. Display Unit

Positive Logic (M7E-01BRP2/M7E-01BGP2)

Connector pin No.	Input signal					Display conditions
	⑨	⑦	⑥	⑧	④	
Terminal symbol	BI	+	-	1	DP	
Input signals	L	L	L	L	L	Blank
	L	H	L	L	L	+
	L	L	H	L	L	-
	L	L	L	H	L	/
	L	L	L	L	H	.
	H	*	*	*	*	Blank (See note.)

Note: BI takes precedence over any input signal.

* Either high or low.

Unit Display Unit

This display lights when voltage is applied to the power supply terminals (V and G).

V-G terminals	Display
Open circuit	Blank
Voltage applied	Lit

Decimal/Hexadecimal Display Unit (Single-color Models with Zero Suppression)

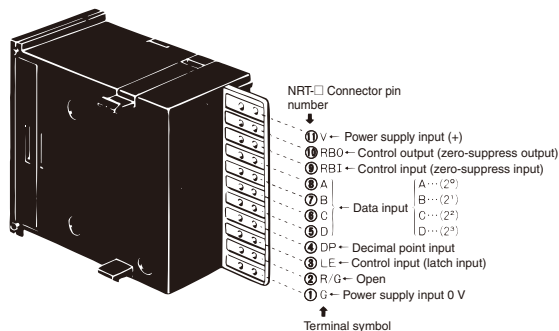

Decimal/Hexadecimal Display Unit (Single-color Model with Blanking)

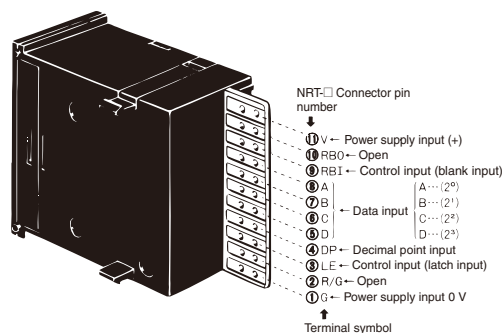

Negative Logic (M7E-01BRN2/M7E-01BGN2)

Connector pin No.	Input signal					Display conditions
	⑨	⑦	⑥	⑧	④	
Terminal symbol	BI	+	-	1	DP	
Input signals	H	H	H	H	H	Blank
	H	L	H	H	H	+
	H	H	L	H	H	-
	H	H	H	L	H	/
	H	H	H	H	L	.
	L	*	*	*	*	Blank (See note.)

Note: BI takes precedence over any input signal.

* Either high or low.

Decimal/Hexadecimal Display Unit

Models with Zero Suppression

Positive logic (M7E-01DRP2/M7E-01DGP2/M7E-01HRP2/M7E-01HGP2)

Connector pin No.	Input								Out-put	Display condition	
	③	⑤	⑥	⑦	⑧	④	⑨	⑩			
Terminal number	3	5	6	7	8	4	9	10			
Terminal symbol	LE	D	C	B	A	DP	RBI	RBO	Decimal	Hexadecimal	
Input signals	L	L	L	L	L	L	L	L		0	
	L	L	L	L	H	L	*	L		.	
	L	L	L	H	L	L	*	L		2	
	L	L	L	H	H	L	*	L		3	
	L	L	H	L	L	L	*	L		4	
	L	L	H	L	L	L	*	L		5	
	L	L	H	H	L	L	*	L		6	
	L	L	H	H	H	L	*	L		7	
	L	H	L	L	L	L	*	L		8	
	L	H	L	L	H	L	*	L		9	
	L	H	L	H	L	L	*	L	-	A	
	L	H	L	H	H	L	*	L	Blank	b	
	L	H	H	L	L	L	*	L	Blank	c	
	L	H	H	L	H	L	*	L	Blank	d	
	L	H	H	H	L	L	*	L	Blank	e	
	L	H	H	H	H	L	*	L	Blank	f	
	L	*	*	*	*	H	*	L	.		
	*	L	L	L	L	L	H	H	Blank (See note.)		
	H	*	*	*	*	*	*	*	Retains the display conditions of A through D and DP terminals before LE goes high. RBI is not related.		

Note: The display will go blank when the data input is "0" and the DP is OFF.

* Either high or low

Negative logic (M7E-01DRN2/M7E-01DGN2/M7E-01DRGN2/M7E-01HRN2/M7E-01HGN2)

Connector pin No.	Input								Out-put	Display condition	
	③	⑤	⑥	⑦	⑧	④	⑨	⑩			
Terminal number	3	5	6	7	8	4	9	10			
Terminal symbol	LE	D	C	B	A	DP	RBI	RBO	Decimal	Hexadecimal	
Input signals	H	H	H	H	H	H	H	H		0	
	H	H	H	H	L	H	*	H		.	
	H	H	H	L	H	H	*	H		2	
	H	H	H	L	L	H	*	H		3	
	H	H	L	H	H	H	*	H		4	
	H	H	L	H	L	H	*	H		5	
	H	H	L	L	H	H	*	H		6	
	H	H	L	L	L	H	*	H		7	
	H	L	H	H	H	H	*	H		8	
	H	L	H	H	L	H	*	H		9	
	H	L	H	L	H	H	*	H	-	A	
	H	L	H	L	L	H	*	H	Blank	b	
	H	L	L	H	H	H	*	H	Blank	c	
	H	L	L	H	L	H	*	H	Blank	d	
	H	L	L	L	H	H	*	H	Blank	e	
	H	L	L	L	L	H	*	H	Blank	f	
	H	*	*	*	*	L	*	H	.		
	*	H	H	H	H	H	L	L	Blank (See note.)		
	L	*	*	*	*	*	*	*	Retains the display conditions of A through D, DP and R/G terminals before LE goes low. RBI is not related.		

Note: The display will go blank when the data input is "0" and the DP is OFF.

* Either high or low

Models with Blanking

Positive logic (M7E-01DRP2-B/M7E-01DGP2-B/M7E-01HRP2-B/M7E-01HGP2-B)

Connector pin No.	Input							Display condition	
	③	⑨	⑤	⑥	⑦	⑧	④	Decimal	Hexa-decimal
Terminal number	3	9	5	6	7	8	4		
Terminal symbol	LE	RBI	D	C	B	A	DP		
Input signals	L	L	L	L	L	L	L	0	
	L	L	L	L	L	H	L	1	
	L	L	L	L	H	L	L	2	
	L	L	L	L	H	H	L	3	
	L	L	L	H	L	L	L	4	
	L	L	L	H	L	H	L	5	
	L	L	L	H	H	L	L	6	
	L	L	L	H	H	H	L	7	
	L	L	H	L	L	L	L	8	
	L	L	H	L	L	H	L	9	
	L	L	H	L	H	L	L	-	A
	L	L	H	L	H	H	L	Blank	b
	L	L	H	H	L	L	L	Blank	c
	L	L	H	H	L	H	L	Blank	d
	L	L	H	H	H	L	L	Blank	e
	L	L	H	H	H	H	L	Blank	f
	*	L	*	*	*	*	H	.	
	*	H	*	*	*	*	*	Blank (See note.)	
	H	L	*	*	*	*	*	Retains the display conditions of A through D terminals before LE goes high. DP is not related.	

Note: RBI takes precedence over any input signal.

* Either high or low

Negative logic (M7E-01DRN2-B/M7E-01DGN2-B/M7E-01DRGN2-B/M7E-01HRN2-B/M7E-01HGN2-B)

Connector pin No.	Input							Display condition	
	③	⑨	⑤	⑥	⑦	⑧	④	Decimal	Hexa-decimal
Terminal number	3	9	5	6	7	8	4		
Terminal symbol	LE	RBI	D	C	B	A	DP		
Input signals	H	H	H	H	H	H	H	0	
	H	H	H	H	H	L	H	1	
	H	H	H	H	L	H	H	2	
	H	H	H	H	L	L	H	3	
	H	H	H	L	H	H	H	4	
	H	H	H	L	H	L	H	5	
	H	H	H	L	L	H	H	6	
	H	H	H	L	L	L	H	7	
	H	H	L	H	H	H	H	8	
	H	H	L	H	H	L	H	9	
	H	H	L	H	L	H	H	-	A
	H	H	L	H	L	L	H	Blank	b
	H	H	L	L	H	H	H	Blank	c
	H	H	L	L	H	L	H	Blank	d
	H	H	L	L	L	H	H	Blank	e
	H	H	L	L	L	L	H	Blank	f
	*	H	*	*	*	*	L	.	
	*	L	*	*	*	*	*	Blank (See note.)	
	L	H	*	*	*	*	*	Retains the display conditions of A through D, and R/G terminals before LE goes low. DP is not related.	

Note: RBI takes precedence over any input signal.

* Either high or low

Models with Dynamic Outputs

±1. Display Unit

(M7E-01BRD2/M7E-01BGD2)

Connector pin No.	Input						Display condition
	③	⑨	⑦	⑥	⑧	④	
Terminal symbol	LE	BI	+	-	1	DP	
Input signals	L	H	L	L	L	H	Blank
	L	H	H	L	L	H	+
	L	H	L	H	L	H	-
	L	H	L	L	H	H	1
	*	H	*	*	*	L	.
	*	L	*	*	*	*	Blank (See note.)
H	H	*	*	*	*	Retains the display conditions of +, -, and 1 before LE goes high. DP is not related.	

Note: BI takes precedence over any input signal.

* Either high or low

Decimal Display Unit

Models with Zero Suppression (M7E-01DRD2/M7E-01DGD2)

Connector pin No.	Input							Out-put	Display condition	
	③	⑤	⑥	⑦	⑧	④	⑨			⑩
	Terminal number	3	5	6	7	8	4			9
Terminal symbol	LE	D	C	B	A	DP	RBI	RBO		
Input signals	L	L	L	L	L	H	L	L	0 (See note 1.)	
	L	L	L	L	H	H	*	L	1	
	L	L	L	H	L	H	*	L	2	
	L	L	L	H	H	H	*	L	3	
	L	L	H	L	L	H	*	L	4	
	L	L	H	L	H	H	*	L	5	
	L	L	H	H	L	H	*	L	6	
	L	L	H	H	H	H	*	L	7	
	L	H	L	L	L	H	*	L	8	
	L	H	L	L	H	H	*	L	9	
	L	H	L	H	L	H	*	L	-	
	L	H	L	H	L	H	*	L	-	
	L	H	L	H	H	H	*	L	Blank	
	L	H	H	L	L	H	*	L	Blank	
	L	H	H	L	H	H	*	L	Blank	
	L	H	H	H	L	H	*	L	Blank	
	L	H	H	H	H	H	*	L	Blank	
	L	*	*	*	*	L	*	L	.	
	*	L	L	L	L	H	H	H	Blank (See note 2.)	
	H	*	*	*	*	*	*	*	Retains the display conditions of A through D, and DP terminals before LE goes high. RBI is not related.	

Note: 1. Input low for RBI when data "0" is displayed. RBI will go high in open mode and the zero suppression will function.

2. The display will go blank when the data input is "0" and the DP is OFF.

* Either high or low

Models with Blanking (M7E-01DRD2-B/M7E-01DGD2-B)

Connector pin No.	Input							Display condition	
	③	⑨	⑤	⑥	⑦	⑧	④		
	Terminal number	3	9	5	6	7	8		4
Terminal symbol	LE	RBI	D	C	B	A	DP		
Input signals	L	H	L	L	L	L	H	0	
	L	H	L	L	L	H	H	1	
	L	H	L	L	H	L	H	2	
	L	H	L	L	H	H	H	3	
	L	H	L	H	L	L	H	4	
	L	H	L	H	L	H	H	5	
	L	H	L	H	H	L	H	6	
	L	H	L	H	H	H	H	7	
	L	H	H	L	L	L	H	8	
	L	H	H	L	L	H	H	9	
	L	H	H	L	H	L	H	-	
	L	H	H	L	H	H	H	Blank	
	L	H	H	H	L	L	H	Blank	
	L	H	H	H	L	H	H	Blank	
	L	H	H	H	H	L	H	Blank	
	L	H	H	H	H	H	H	Blank	
	*	H	*	*	*	*	*	L	.
	*	L	*	*	*	*	*	*	Blank (See note.)
	H	H	*	*	*	*	*	*	Retains the display conditions of A through D terminals before LE goes high. DP is not related.

Note: RBI takes precedence over any input signal.

* Either high or low

Block Diagram

Note: Circled numbers are the board terminal numbers.

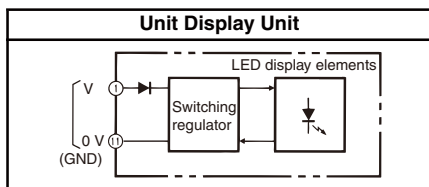
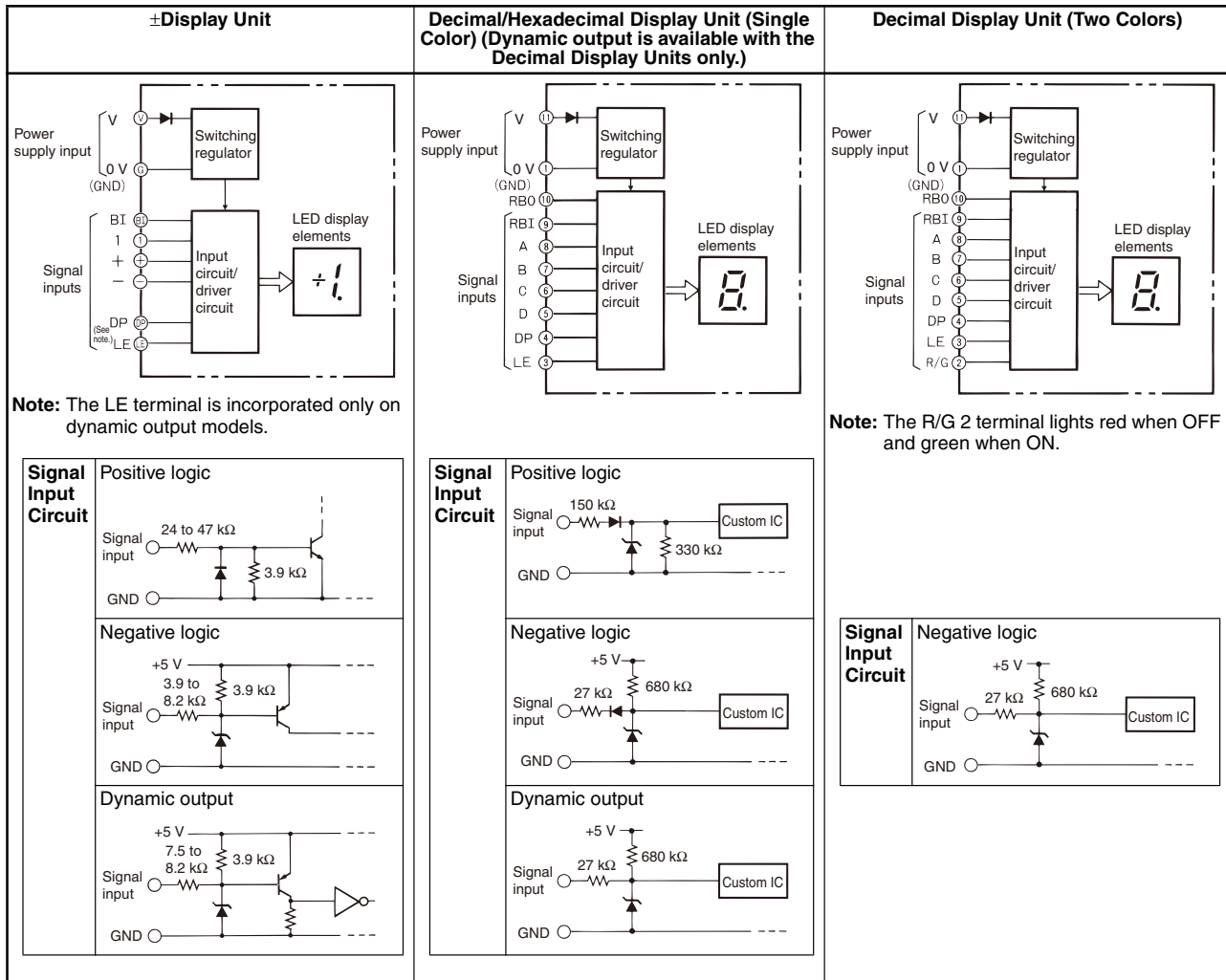

Note: The terminal numbers of the Unit Display Unit are different from the terminal numbers of the connector. Refer to *Terminal Arrangements and Functions* on page 3 for details.

External Connections

Refer to the *Terminal Arrangement* on page 3 and the *Block Diagram* on page 8 for external connections for each unit.

Example of connection to a PLC.

- Refer to the PLC operation manual before connecting the PLC.
- The number of wires can be reduced by using a PLC with dynamic outputs.

Static Output Unit

1. M7E-01□□P2 Positive Logic Model Use a PNP Transistor Output Unit for the PLC Output Unit.

Connected to C500-OD212 Transistor Output Unit

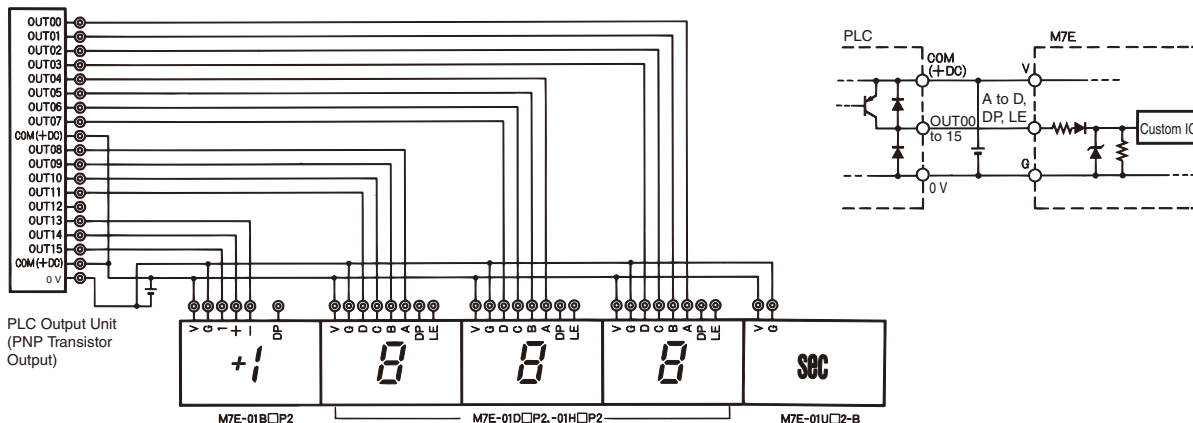

2. M7E-01□□N2 Negative Logic Model Use an NPN Transistor Output Unit for the PLC Output Unit.

Connected to C500-OD213 Transistor Output Unit

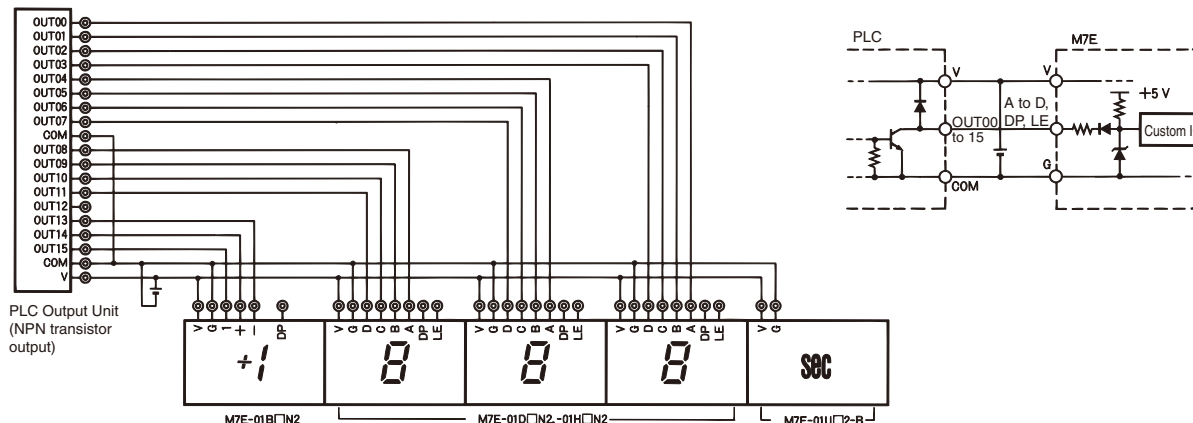

Using Dynamic Output Units

1. M7E-01□□D2 Dynamic Output Model

1. Connected to C500-OD211 Transistor Output Unit

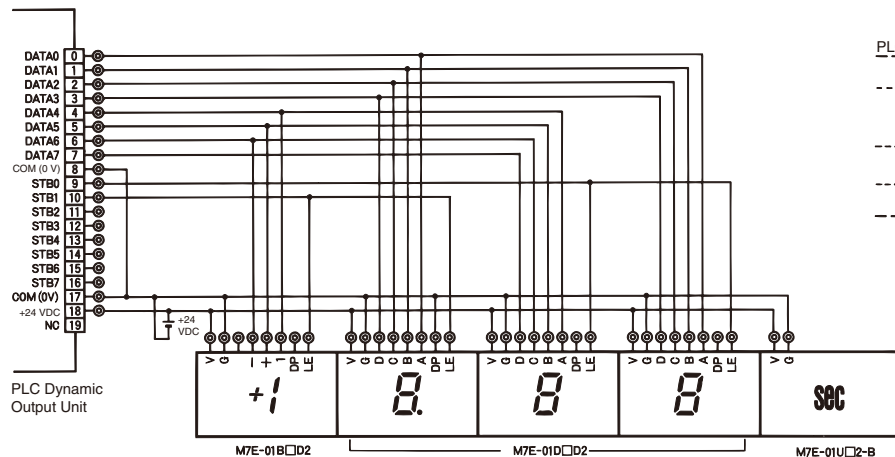

2. Connected to C200-OD215 Transistor Output Unit

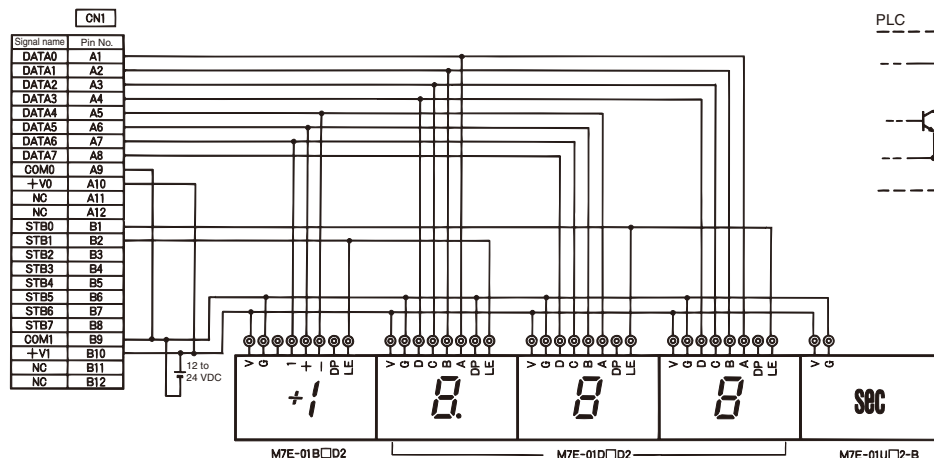

Note: 1. When using the C200H-OD215, the selector on the rear cover of the C200H-OD215 must be set as follows:

SW1 (dynamic output mode)	ON
SW2	OFF
SW3	OFF
SW4	OFF
SW5 (positive logic output)	ON
SW6	OFF

2. Refer to the C200H High-density I/O Unit operation manual for the C200H-OD215 and refer to the hardware section of the C500 operation manual for the C500-OD211.

2. M7E-01□□P2 Positive Logic Model An external pull-up resistor is required.

Connected to C500-OD211 or C200H-OD215

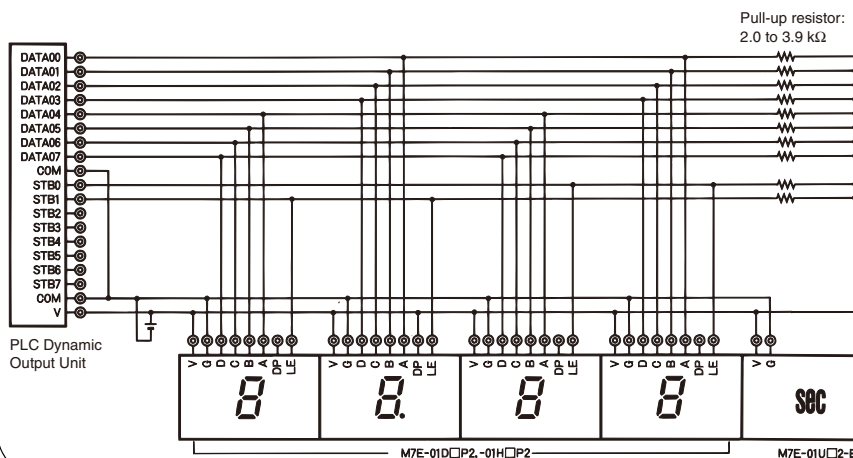

Note: 1. Supply 24 VDC only. The PLC does not operate with the M7E Negative Logic Model.

2. The resistance of the pull-up resistor is 2.0 to 3.9 kΩ (1 W). A resistance of 3.3 kΩ is recommended.

Operation

■ Operation Timing (Input Signal Timing)

Positive Logic

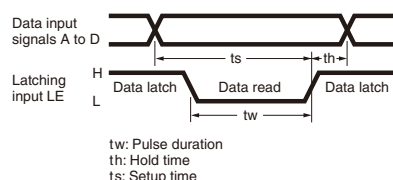

Negative logic

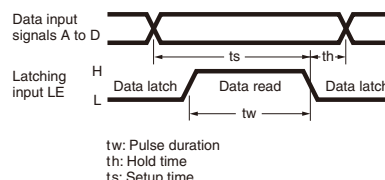

Pulse duration (tw)	1.5 ms min.
Hold time (th)	0.75 ms min.
Setup time (ts)	2.25 ms min.

■ Operation Chart

- The following example shows the relationship between each input terminal signal and the display condition for a Negative-logic Decimal Display Unit with Blanking.

Terminal displayed value	0	1	2	3	4	5	6	7	8	9	Description
Data											
Input signals											Inputs the data signal as BCD (or binary code).
A (2 ⁰)	[Timing diagram for A]										
B (2 ¹)	[Timing diagram for B]										
C (2 ²)	[Timing diagram for C]										
D (2 ³)	[Timing diagram for D]										
DP	[Timing diagram for DP]										
LE	[Timing diagram for LE]										Low when all the display turns OFF. (High is maintained until the signal goes low.)
Display condition	0	1	2	3	4	5	6	7	8	9	---
Remarks	The "1" display is turned OFF by the LE signal. The "5" display is turned OFF by the LE signal.										---

- Using the latch input (LE) terminal for each Unit, the data input terminals (A to D) can be used in common yet still enable display on each Unit (example of a 3-digit dynamic-output model with positive logic).

Data input signals (A to D)	0 (power: ON)	5	7	6	1	
Latch input signals						
3 rd digit (LE3)	[Timing diagram for 3rd digit]					
2 nd digit (LE2)	[Timing diagram for 2nd digit]					
1 st digit (LE1)	[Timing diagram for 1st digit]					
Display condition	000	500	570	576	176	A numeric value is displayed one digit at a time via data signals A to D.

Example of Zero Suppression Usage: Description Using Negative Logic Model

The zero suppression function operates when the display is 0, RBI is low and the decimal point is not lit.

Example 1: The RBI input and RBO output of each digit are open when zero suppression is not being used.

Example 2: Wired as shown to display only 0 for the rightmost digit when zero suppression is being used.

Example 3: Zeros are suppressed only for the digits on the left of the digit where the decimal is lit when both zero suppression and a decimal point are being used.

Example 4: Zeros are suppressed to the right of the first digit below the decimal point when both zero suppression and a decimal point are being used. If the first-to-fourth-digit values are all 0 and the decimal point is lit at the fourth digit, 0.0000 will be displayed. (There is no data in 00.)

Note: Use RBO output for the RBI input connection only.

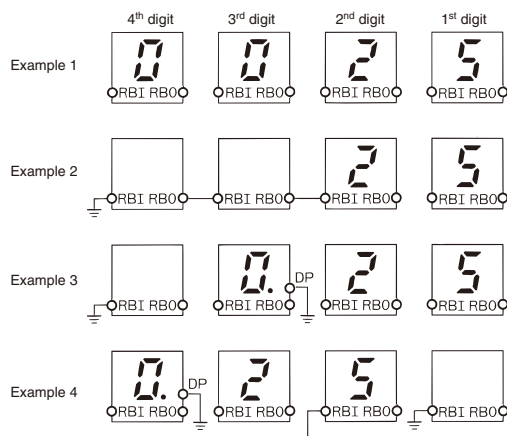

Dimensions

Note: All units are in millimeters unless otherwise indicated.

M7E-01□□□□2

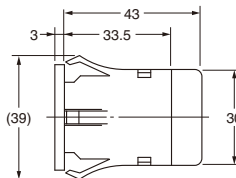
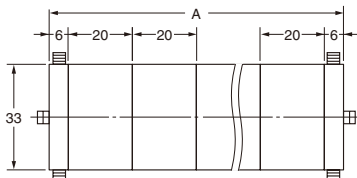
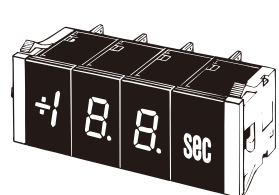

(Unit: mm)

Number of Units (n)	Dimensions A (n×20+12)	Dimensions B (n×20+10)
1	32±0.4	30±0.4
2	52±0.4	50±0.4
3	72±0.4	70±0.4
4	92±0.4	90±0.4
5	112±0.8	110±0.8
6	132±0.8	130±0.8
7	152±0.8	150±0.8
8	172±0.8	170±0.8

LED

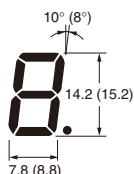

Values in parentheses are for the two-color (red and green) Digital Display Units.

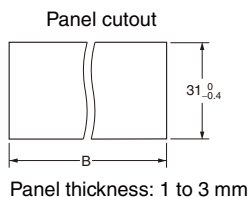
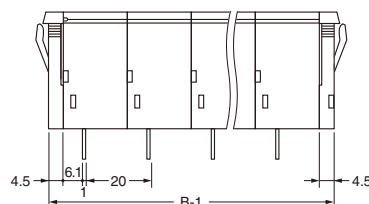

- Note:**
- Dimensions A and B include End Plates. Inclusion of spacers increases the length by 10 mm per spacer.
 - Tolerance is ±0.4 mm unless otherwise specified.

■ Accessories (Order Separately)

End Plate

M7E-012M(-1)

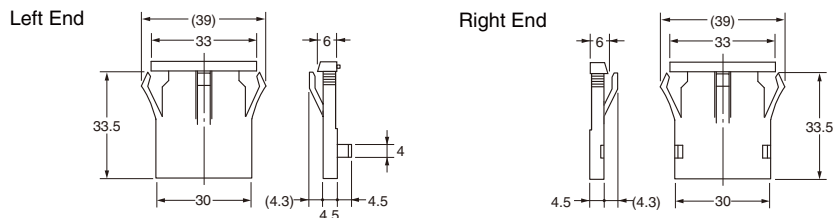

Note: Tolerance is ± 0.4 mm unless otherwise specified.

Spacer

M7E-012PA(-1)

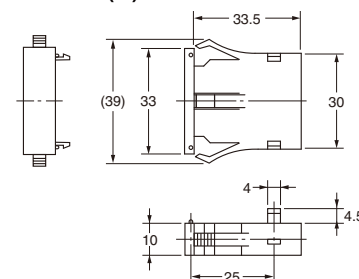

Connector

NRT-C Soldered Terminal

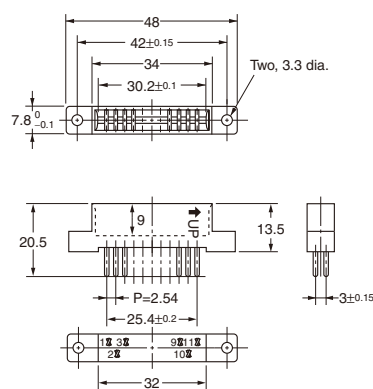

NRT-CN Soldered Terminal

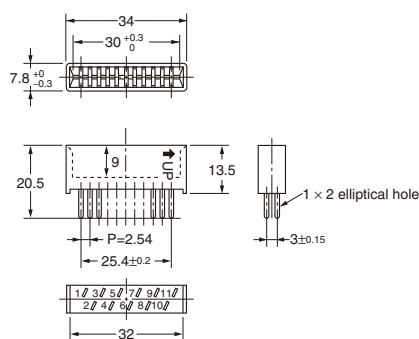

NRT-CP PCB Terminal

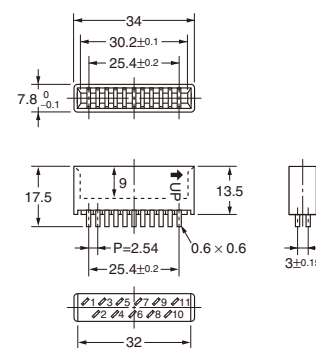

Face Plate

- The required face plate is used with the Unit Display Unit, which incorporates a surface-lighting LED.
- The following face plates are available. When ordering the M7E-01U□2-*, add the suffix according to your requirement.
- Custom face plates can be made. For the procedure to make face plates, refer to *Safety Precautions for M7E*.

Symbol	A	B	C	D	E	F	G	H	J	JC1	K	V	Z1	Z2
Display contents	Blank display	sec	min	h	g	kg	mm	cm	m	m/min	°C	rpm	%	ppm

ALL DIMENSIONS SHOWN ARE IN MILLIMETERS.

To convert millimeters into inches, multiply by 0.03937. To convert grams into ounces, multiply by 0.03527.

In the interest of product improvement, specifications are subject to change without notice.

Safety Precautions for M7E

■ Precautions for Correct Use

Display Units

Installation environment

- Use the Unit in locations that are not subject to organic solvents (thinner, benzene, etc.), strong alkali, strong acid, sunlight, and corrosive gases.
- These Display Units are designed for indoor use only. Visibility may be significantly reduced if the Unit is used outside or in locations where the ambient brightness exceeds the brightness of the M7E. The product is not drip-proof. Use the product where it will not be subject to water or oil splashing.
- Use the Units in areas not subject to vibration or shock in excess of specifications.

Mounting

- Link the Units by snapping the projecting tips and slots together.

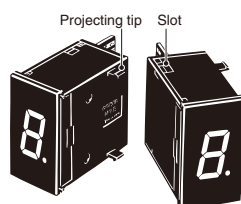

- To undo the linkage, use a slotted screwdriver as shown in the following figure and press the upper and lower tips while separating.

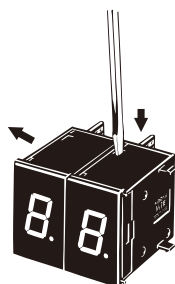

Connector Insertion

When inserting the connector, make sure that the UP arrow is pointing upwards.

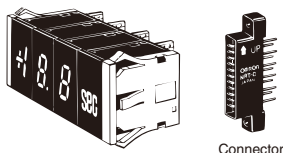

- When the End Plates are linked, the entire set can be quickly mounted and fastened to a panel. Confirm that the links between units and End Plates are secure, and then securely fasten the End Plate tips to the panel.

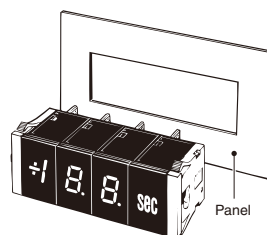

Wiring and Connections

Make sure that no wire is more than five meters long when wiring.

Handling

There are projecting tips made of resin on the side of each Display Unit. Be sure not to drop the Display Unit, otherwise the projecting tips may break.

Procedure for Making Face Plates for M7E-01 Unit Display Unit

Custom face plates can be made according to the following guidelines.

1. Prepare a blank Unit Display Unit (M7E-01UR2-A or M7E-01UG2-A) for the desired lighting color.
2. Take transparent polyester film (with thickness equivalent to 0.188) and cut it to the following dimensions.

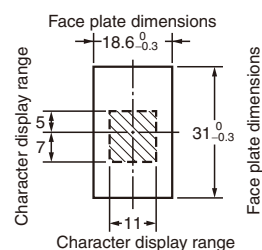

3. Print solid black on the film covering all areas except the character and so that the desired unit character is within the character display range (with the unit character transparent).
4. Install the completed face plate into the Unit Display Unit.

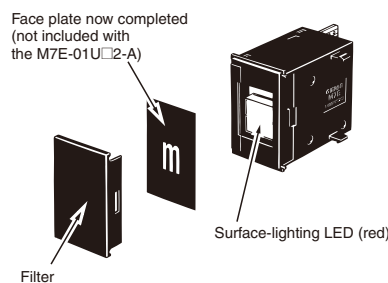

Mother Board

Wiring and Connections

Secure the cable and lead wires with the panel so that no excessive force will be imposed on the input connector or power supply terminals.

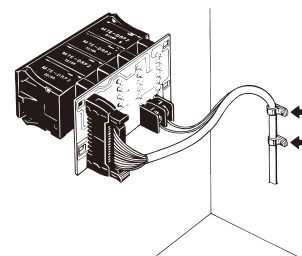

M7E Connection

- Connection of Mother Board and M7E

Mother board	Positive	Negative	Dynamic	
Static	○	○	× (See note.)	○: Possible
Dynamic	○	○	○	×: Impossible

Note: Do not connect the Mother Board static model to the M7E-01D□D2(-B) dynamic model, otherwise LE will be held.

- When using the M7E-01□□P2(-B) positive logic standard model, a pullup resistor may be required. Check the output circuit of the connecting device and use a pull-up resistor if necessary.
- All M7E models used on a single Mother Board must be identical.

Connecting or Disconnecting the M7E

When connecting the M7E to or disconnecting the M7E from the Mother Board, hold the front panel of the M7E or the case and be sure to apply appropriate force on the top and bottom of the Mother Board alternately.

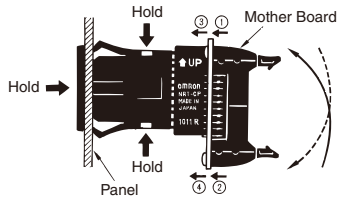

ALL DIMENSIONS SHOWN ARE IN MILLIMETERS.

To convert millimeters into inches, multiply by 0.03937. To convert grams into ounces, multiply by 0.03527.

In the interest of product improvement, specifications are subject to change without notice.

Read and Understand This Catalog

Please read and understand this catalog before purchasing the products. Please consult your OMRON representative if you have any questions or comments.

Warranty and Limitations of Liability

WARRANTY

OMRON's exclusive warranty is that the products are free from defects in materials and workmanship for a period of one year (or other period if specified) from date of sale by OMRON.

OMRON MAKES NO WARRANTY OR REPRESENTATION, EXPRESS OR IMPLIED, REGARDING NON-INFRINGEMENT, MERCHANTABILITY, OR FITNESS FOR PARTICULAR PURPOSE OF THE PRODUCTS. ANY BUYER OR USER ACKNOWLEDGES THAT THE BUYER OR USER ALONE HAS DETERMINED THAT THE PRODUCTS WILL SUITABLY MEET THE REQUIREMENTS OF THEIR INTENDED USE. OMRON DISCLAIMS ALL OTHER WARRANTIES, EXPRESS OR IMPLIED.

LIMITATIONS OF LIABILITY

OMRON SHALL NOT BE RESPONSIBLE FOR SPECIAL, INDIRECT, OR CONSEQUENTIAL DAMAGES, LOSS OF PROFITS, OR COMMERCIAL LOSS IN ANY WAY CONNECTED WITH THE PRODUCTS, WHETHER SUCH CLAIM IS BASED ON CONTRACT, WARRANTY, NEGLIGENCE, OR STRICT LIABILITY.

In no event shall responsibility of OMRON for any act exceed the individual price of the product on which liability is asserted.

IN NO EVENT SHALL OMRON BE RESPONSIBLE FOR WARRANTY, REPAIR, OR OTHER CLAIMS REGARDING THE PRODUCTS UNLESS OMRON'S ANALYSIS CONFIRMS THAT THE PRODUCTS WERE PROPERLY HANDLED, STORED, INSTALLED, AND MAINTAINED AND NOT SUBJECT TO CONTAMINATION, ABUSE, MISUSE, OR INAPPROPRIATE MODIFICATION OR REPAIR.

Application Considerations

SUITABILITY FOR USE

OMRON shall not be responsible for conformity with any standards, codes, or regulations that apply to the combination of products in the customer's application or use of the product.

At the customer's request, OMRON will provide applicable third party certification documents identifying ratings and limitations of use that apply to the products. This information by itself is not sufficient for a complete determination of the suitability of the products in combination with the end product, machine, system, or other application or use.

The following are some examples of applications for which particular attention must be given. This is not intended to be an exhaustive list of all possible uses of the products, nor is it intended to imply that the uses listed may be suitable for the products:

- Outdoor use, uses involving potential chemical contamination or electrical interference, or conditions or uses not described in this catalog.
- Nuclear energy control systems, combustion systems, railroad systems, aviation systems, medical equipment, amusement machines, vehicles, safety equipment, and installations subject to separate industry or government regulations.
- Systems, machines, and equipment that could present a risk to life or property.

Please know and observe all prohibitions of use applicable to the products.

NEVER USE THE PRODUCTS FOR AN APPLICATION INVOLVING SERIOUS RISK TO LIFE OR PROPERTY WITHOUT ENSURING THAT THE SYSTEM AS A WHOLE HAS BEEN DESIGNED TO ADDRESS THE RISKS, AND THAT THE OMRON PRODUCT IS PROPERLY RATED AND INSTALLED FOR THE INTENDED USE WITHIN THE OVERALL EQUIPMENT OR SYSTEM.

Disclaimers

CHANGE IN SPECIFICATIONS

Product specifications and accessories may be changed at any time based on improvements and other reasons.

It is our practice to change model numbers when published ratings or features are changed, or when significant construction changes are made. However, some specifications of the product may be changed without any notice. When in doubt, special model numbers may be assigned to fix or establish key specifications for your application on your request. Please consult with your OMRON representative at any time to confirm actual specifications of purchased product.

DIMENSIONS AND WEIGHTS

Dimensions and weights are nominal and are not to be used for manufacturing purposes, even when tolerances are shown.

ERRORS AND OMISSIONS

The information in this catalog has been carefully checked and is believed to be accurate; however, no responsibility is assumed for clerical, typographical, or proofreading errors, or omissions.

PERFORMANCE DATA

Performance data given in this catalog is provided as a guide for the user in determining suitability and does not constitute a warranty. It may represent the result of OMRON's test conditions, and the users must correlate it to actual application requirements. Actual performance is subject to the OMRON Warranty and Limitations of Liability.

PROGRAMMABLE PRODUCTS

OMRON shall not be responsible for the user's programming of a programmable product, or any consequence thereof.

COPYRIGHT AND COPY PERMISSION

This catalog shall not be copied for sales or promotions without permission.

This catalog is protected by copyright and is intended solely for use in conjunction with the product. Please notify us before copying or reproducing this catalog in any manner, for any other purpose. If copying or transmitting this catalog to another, please copy or transmit it in its entirety.