

BGF110

SD Card Interface ESD Protection

Small Signal Discretes



Never stop thinking

Edition 2007-07-04

**Published by
Infineon Technologies AG
81726 München, Germany**

**© Infineon Technologies AG 2007.
All Rights Reserved.**

Legal Disclaimer

The information given in this document shall in no event be regarded as a guarantee of conditions or characteristics ("Beschaffheitsgarantie"). With respect to any examples or hints given herein, any typical values stated herein and/or any information regarding the application of the device, Infineon Technologies hereby disclaims any and all warranties and liabilities of any kind, including without limitation warranties of non-infringement of intellectual property rights of any third party.

Information

For further information on technology, delivery terms and conditions and prices please contact your nearest Infineon Technologies Office (www.infineon.com).

Warnings

Due to technical requirements components may contain dangerous substances. For information on the types in question please contact your nearest Infineon Technologies Office.

Infineon Technologies Components may only be used in life-support devices or systems with the express written approval of Infineon Technologies, if a failure of such components can reasonably be expected to cause the failure of that life-support device or system, or to affect the safety or effectiveness of that device or system. Life support devices or systems are intended to be implanted in the human body, or to support and/or maintain and sustain and/or protect human life. If they fail, it is reasonable to assume that the health of the user or other persons may be endangered.

BGF110

Revision History: 2007-07-04, V2.2

Previous Version: 2006-10-17

Page	Subjects (major changes since last revision)
4	EMI and cross talk feature added
4	Contact discharge added

SD Card Interface ESD Protection

Feature

- ESD protection for SD Card interface
- Integrated ESD protection up to 15 kV contact discharge
- Very good EMI filtering with very low cross talk
- Green wafer level package with SnAgSu solder balls
- 400 μm solder ball pitch

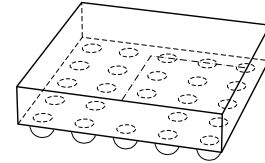

WLP-24-2



Description

The BGF110 is an ESD protection for the SD Card interface using a green wafer level package. External pins are protected up to 15 kV contact discharge according to IEC61000-4-2. A RF filter functionality provides very good RF and EMI suppression on the digital lines with very low cross talk. Sensitivity of the line capacitance on the bias voltage is very low. The wafer level package has a 400 μm solder ball pitch and 250 μm ball diameter (before ball attach).

Type	Package	Marking	Chip
BGF110	WLP-24-2	BGF110	N0720

Table 1 Maximum Ratings

Parameter	Symbol	Values			Unit	Note / Test Condition
		Min.	Typ.	Max.		
Voltage at all pins to GND	V_P	-14		14	V	
Operating temperature range	T_{OP}	-40		+85	$^{\circ}\text{C}$	
Storage temperature range	T_{STG}	-65		+150	$^{\circ}\text{C}$	
Maximum current at all pins	I_{max}			113 ¹⁾	mA	
Electrostatic discharge according to IEC61000-4-2 (contact discharge)						
Ext. IOs: A4, A5, B4, B5, C4, C5, D4, D5, E4, E5	V_E	-15		15	kV	
Int. IOs: A1, A2, B1, B2, C1, C2, C3, D1, D2, E1, E2	V_I	-2		2	kV	

1) Can be applied for 24 hours if thermal power dissipation into PCB is considered properly

Table 2 Electrical Characteristics¹⁾

Parameter	Symbol	Values			Unit	Note / Test Condition
		Min.	Typ.	Max.		
Series Resistors						
$R_1, R_2, R_3, R_4, R_5, R_6, R_7, R_8, R_9$	$R_{1...9}$	32	40	48	Ω	
$R_{11}, R_{12}, R_{13}, R_{14}$	$R_{11...14}$	35	50	65	k Ω	
R_{15}	R_{15}	10.5	15	19.5	k Ω	
R_{21}	R_{21}	329	470	611	k Ω	
Reverse current of ESD protection diodes	I_R		0.1	120	nA	$V_R = 3\text{ V}$
			0.1	120	μA	$V_R = 14\text{ V}$
Line capacitance	C_T		13.5	20	pF	$V_R = 0\text{ V}$
Capacitance of each line to GND ²⁾			11.5			$V_R = 5\text{ V}$

1) at $T_A = 25\text{ }^\circ\text{C}$

2) Without line coupling by resistors $R_{11} - R_{21}$

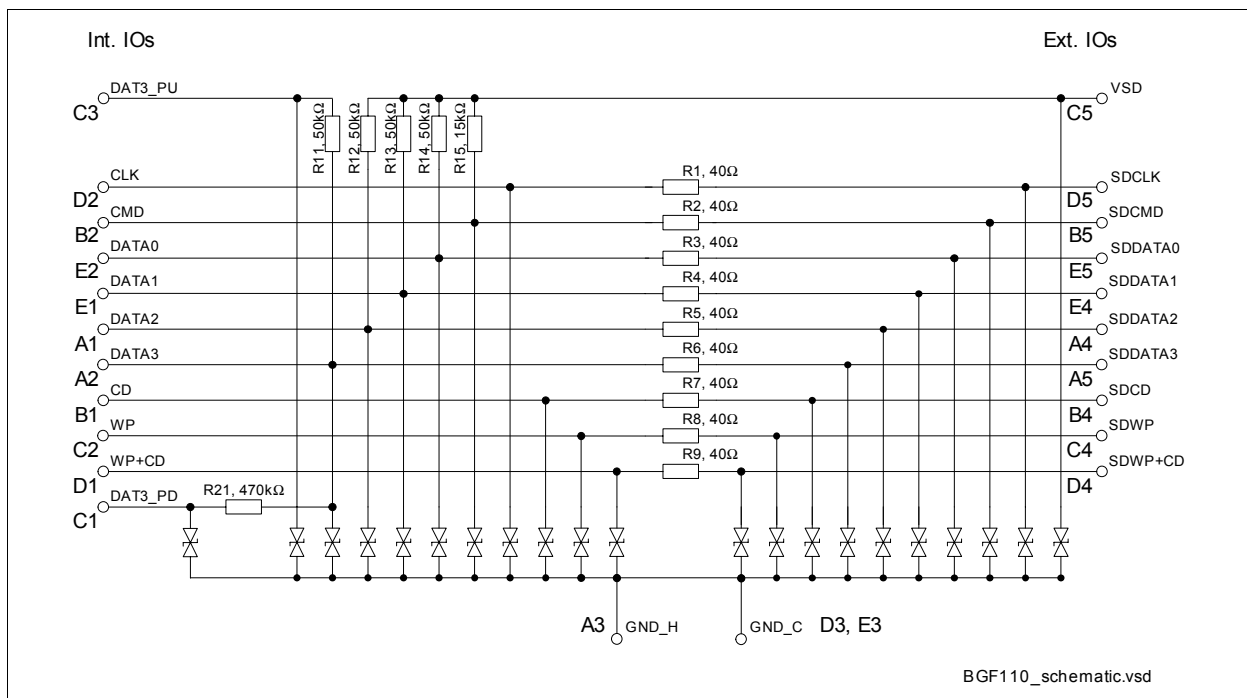

Figure 1 Schematic

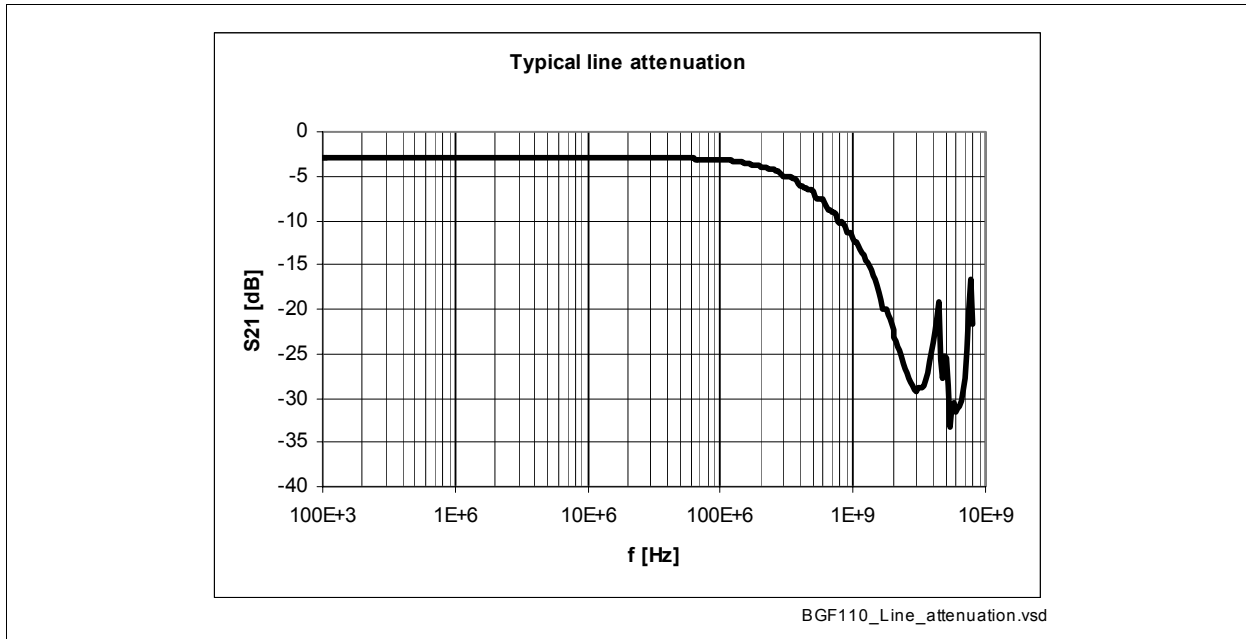

Figure 2 Line attenuation $Z_S = Z_L = 50 \Omega$

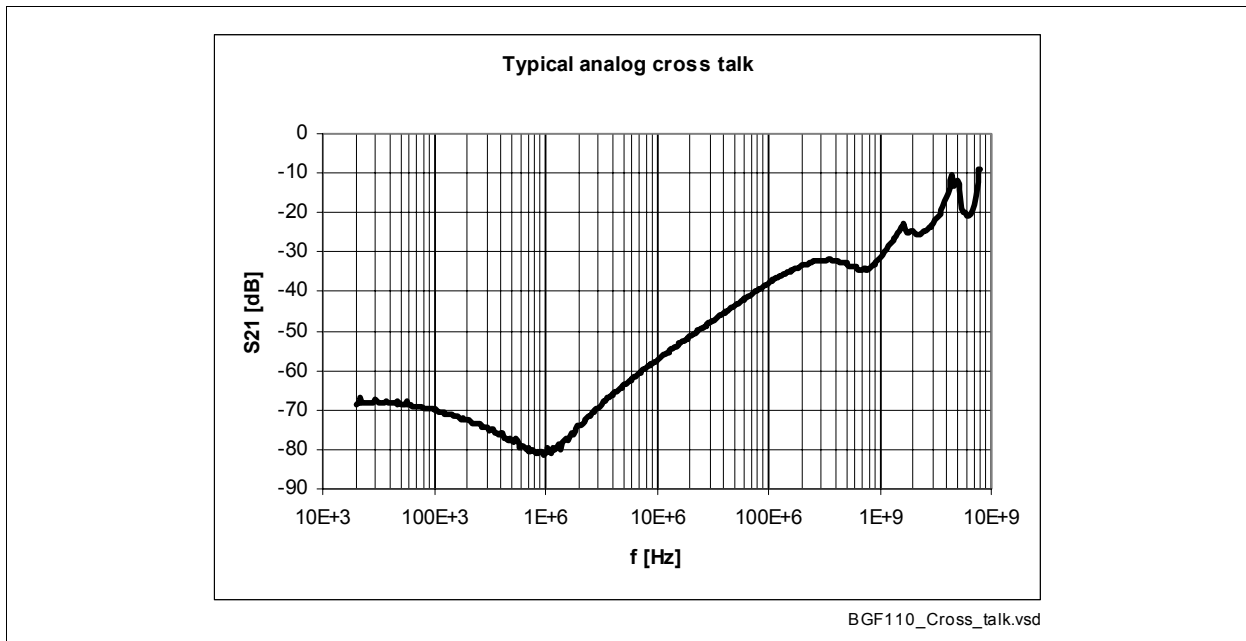

Figure 3 Analog cross talk, $Z_S = Z_L = 50 \Omega$

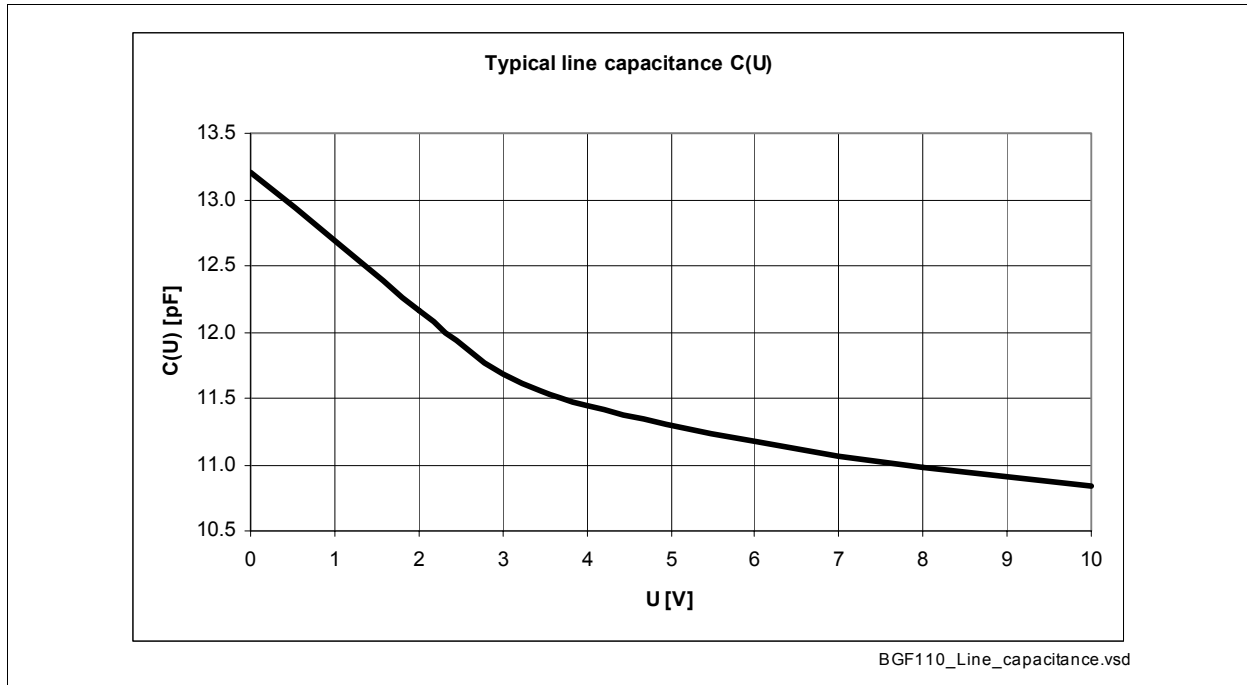

Figure 4 Line capacitance versus bias voltage

Package Outline

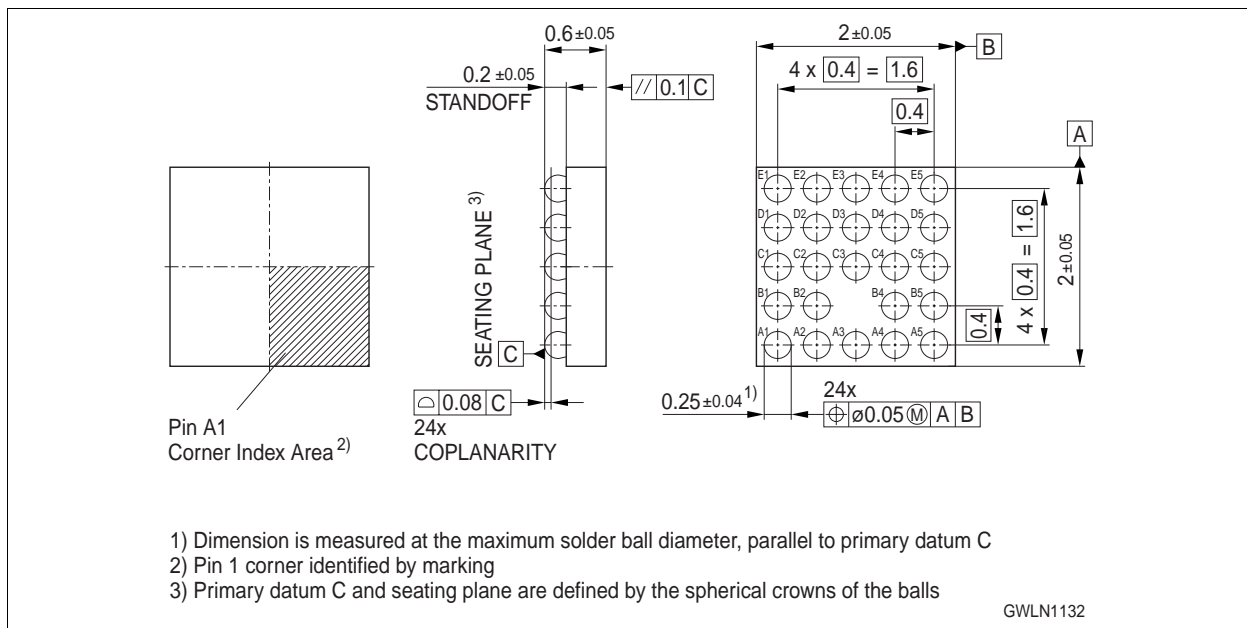

Figure 5 Package WLP-24-2

Tape and reel specification

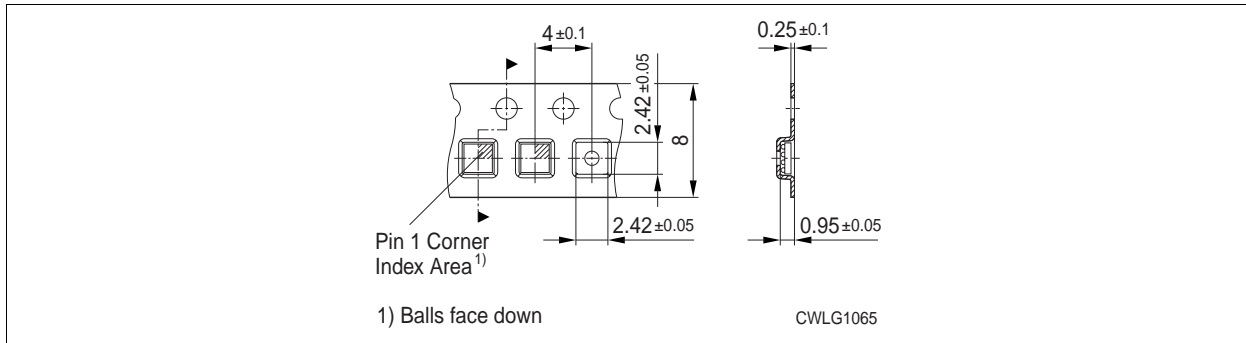

Figure 6 Tape for WLP-24-2