



## Device Overview

The 89HPES34H16 is a member of the IDT PRECISE™ family of PCI Express® switching solutions. The PES34H16 is a 34-lane, 16-port peripheral chip that performs PCI Express packet switching with a feature set optimized for high-performance applications such as servers, storage, and communications/networking. It provides connectivity and switching functions between a PCI Express upstream port and up to fifteen downstream ports and supports switching between downstream ports.

## Features

### ◆ High Performance PCI Express Switch

- Sixteen maximum switch ports
  - Up to three x8 ports that bifurcate up to six x4 ports
  - Ten x1 ports
- Thirty-four 2.5 Gbps embedded SerDes
- Supports pre-emphasis and receive equalization on per-port basis
- Low-latency cut-through switch architecture
- Support for Max Payload Size up to 2048 bytes
- Supports two virtual channels and eight traffic classes
- PCI Express Base Specification Revision 1.1 compliant

### ◆ Flexible Architecture with Numerous Configuration Options

- Port arbitration schemes utilizing round robin algorithms
- Automatic per port link width negotiation from x8 to x4 to x2 or x1
- Automatic lane reversal on all ports
- Automatic polarity inversion on all lanes
- Supports locked transactions, allowing use with legacy software
- Ability to load device configuration from serial EEPROM
- Ability to control device via SMBus

### ◆ Highly Integrated Solution

- Requires no external components
- Incorporates on-chip internal memory for packet buffering and queueing
- Integrates thirty-four 2.5 Gbps embedded full duplex SerDes, 8B/10B encoder/decoder (no separate transceivers needed)

### ◆ Reliability, Availability, and Serviceability (RAS) Features

- Redundant upstream port failover capability
- Supports optional PCI Express end-to-end CRC checking

## Block Diagram

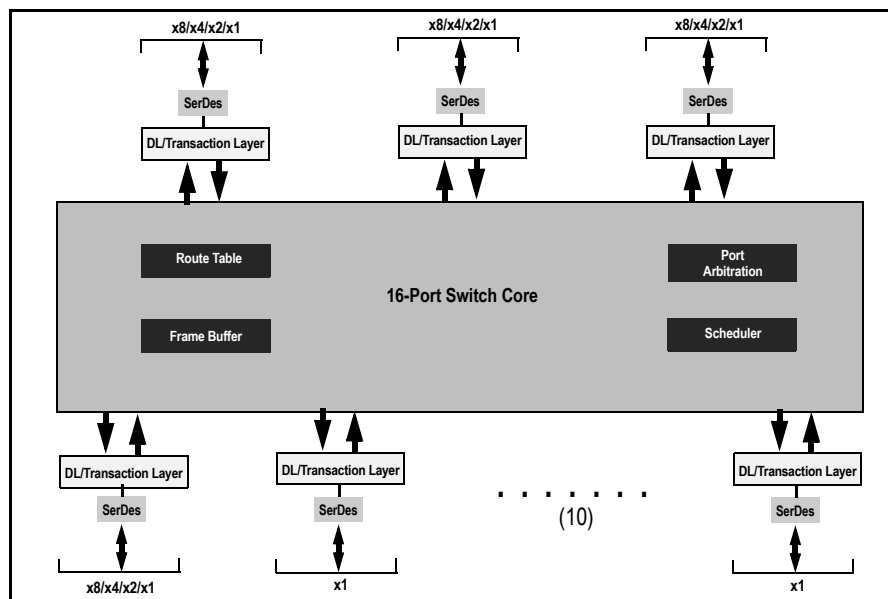

34 PCI Express Lanes  
Up to 6 x4 ports and 10 x1 Ports

Figure 1 Internal Block Diagram

- Internal end-to-end parity protection on all TLPs ensures data integrity even in systems that do not implement end-to-end CRC (ECRC)
- Supports optional PCI Express Advanced Error Reporting
- Supports PCI Express Hot-Plug
  - Compatible with Hot-Plug I/O expanders used on PC motherboards
- Supports Hot-Swap
- ◆ **Power Management**
  - Supports PCI Power Management Interface specification, Revision 1.1 (PCI-PM)
    - Supports powerdown modes at the link level (L0, L0s, L1, L2/L3 Ready and L3) and at the device level (D0, D3<sub>hot</sub>)
  - Unused SerDes disabled
- ◆ **Testability and Debug Features**
  - Built in SerDes Pseudo-Random Bit Stream (PRBS) generator
  - Ability to read and write any internal register via the SMBus
  - Ability to bypass link training and force any link into any mode
  - Provides statistics and performance counters
- ◆ **Thirty-two General Purpose Input/Output pins**
  - Each pin may be individually configured as an input or output
  - Each pin may be individually configured as an interrupt input
  - Some pins have selectable alternate functions
- ◆ **Packaged in a 35mm x 35mm 1156-ball Flip Chip BGA with 1mm ball spacing**

**Product Description**

Utilizing standard PCI Express interconnect, the PES34H16 provides the most efficient I/O connectivity for applications requiring high throughput, low latency, and simple board layout with a minimum number of board layers. Each lane provides 2.5 Gbps of bandwidth in both directions and is fully compliant with PCI Express Base specification 1.1.

The PES34H16 is based on a flexible and efficient layered architecture. The PCI Express layer consists of SerDes, Physical, Data Link and Transaction layers. The PES34H16 can operate either as a store and forward switch or a cut-through switch and is designed to switch memory and I/O transactions. It supports eight Traffic Classes (TCs) and two Virtual Channels (VCs) with sophisticated resource management to enable efficient switching and I/O connectivity.

**SMBus Interface**

The PES34H16 contains two SMBus interfaces. The slave interface provides full access to the configuration registers in the PES34H16, allowing every configuration register in the device to be read or written by an external agent. The master interface allows the default configuration register values of the PES34H16 to be overridden following a reset with values programmed in an external serial EEPROM. The master interface is also used by an external Hot-Plug I/O expander.

Six pins make up each of the two SMBus interfaces. These pins consist of an SMBus clock pin, an SMBus data pin, and 4 SMBus address pins. In the slave interface, these address pins allow the SMBus address to which the device responds to be configured. In the

master interface, these address pins allow the SMBus address of the serial configuration EEPROM from which data is loaded to be configured. The SMBus address is set up on negation of PERSTN by sampling the corresponding address pins. When the pins are sampled, the resulting address is assigned as shown in Table 1.

| Bit | Slave SMBus Address | Master SMBus Address |
|-----|---------------------|----------------------|
| 1   | SSMBADDR[1]         | MSMBADDR[1]          |
| 2   | SSMBADDR[2]         | MSMBADDR[2]          |
| 3   | SSMBADDR[3]         | MSMBADDR[3]          |
| 4   | 0                   | MSMBADDR[4]          |
| 5   | SSMBADDR[5]         | 1                    |
| 6   | 1                   | 0                    |
| 7   | 1                   | 1                    |

**Table 1 Master and Slave SMBus Address Assignment**

As shown in Figure 2, the master and slave SMBuses may be used in a unified or split configuration. In the unified configuration, shown in Figure 2(a), the master and slave SMBuses are tied together and the PES34H16 acts both as a SMBus master as well as a SMBus slave on this bus. This requires that the SMBus master or processor that has access to PES34H16 registers supports SMBus arbitration. In some systems, this SMBus master interface may be implemented using general purpose I/O pins on a processor or micro controller, and may not support SMBus arbitration. To support these systems, the PES34H16 may be configured to operate in a split configuration as shown in Figure 2(b).

In the split configuration, the master and slave SMBuses operate as two independent buses and thus multi-master arbitration is never required. The PES34H16 supports reading and writing of the serial EEPROM on the master SMBus via the slave SMBus, allowing in system programming of the serial EEPROM.

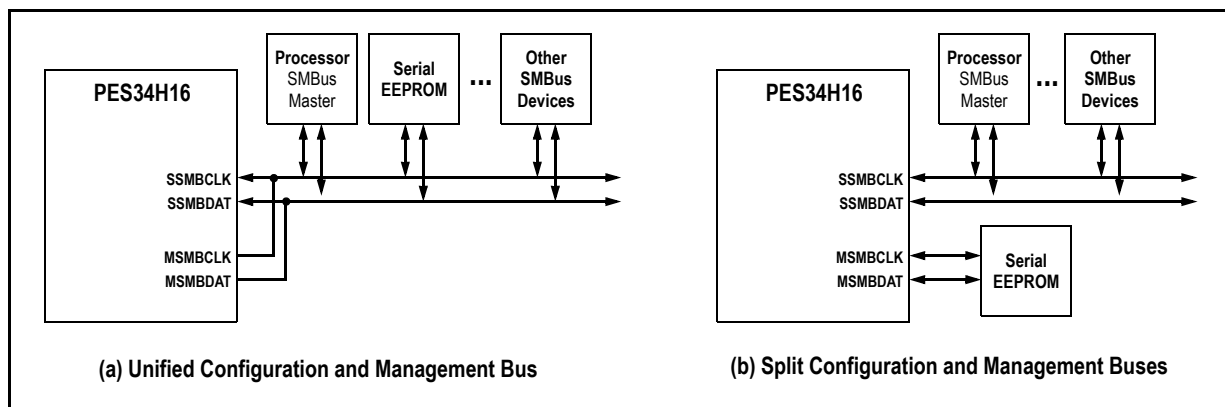

Figure 2 SMBus Interface Configuration Examples

### Hot-Plug Interface

The PES34H16 supports PCI Express Hot-Plug on each downstream port (ports 1 through 15). To reduce the number of pins required on the device, the PES34H16 utilizes an external I/O expander, such as that used on PC motherboards, connected to the SMBus master interface. Following reset and configuration, whenever the state of a Hot-Plug output needs to be modified, the PES34H16 generates an SMBus transaction to the I/O expander with the new value of all of the outputs. Whenever a Hot-Plug input changes, the I/O expander generates an interrupt which is received on the IOEXPINTN input pin (alternate function of GPIO) of the PES34H16. In response to an I/O expander interrupt, the PES34H16 generates an SMBus transaction to read the state of all of the Hot-Plug inputs from the I/O expander.

### General Purpose Input/Output

The PES34H16 provides 32 General Purpose I/O (GPIO) pins that may be individually configured as general purpose inputs, general purpose outputs, or alternate functions. Some GPIO pins are shared with other on-chip functions. These alternate functions may be enabled via software, SMBus slave interface, or serial configuration EEPROM.

### Pin Description

The following tables lists the functions of the pins provided on the PES34H16. Some of the functions listed may be multiplexed onto the same pin. The active polarity of a signal is defined using a suffix. Signals ending with an “N” are defined as being active, or asserted, when at a logic zero (low) level. All other signals (including clocks, buses, and select lines) will be interpreted as being active, or asserted, when at a logic one (high) level. Differential signals end with a suffix “N” or “P.” The differential signal ending in “P” is the positive portion of the differential pair and the differential signal ending in “N” is the negative portion of the differential pair.

| Signal                   | Type | Name/Description   |
|--------------------------|------|--|
| PE0RP[3:0]<br>PE0RN[3:0] | I    | <b>PCI Express Port 0 Serial Data Receive.</b> Differential PCI Express receive pairs for port 0. Port 0 is the upstream port.   |
| PE0TP[3:0]<br>PE0TN[3:0] | O    | <b>PCI Express Port 0 Serial Data Transmit.</b> Differential PCI Express transmit pairs for port 0. Port 0 is the upstream port.   |
| PE1RP[3:0]<br>PE1RN[3:0] | I    | <b>PCI Express Port 1 Serial Data Receive.</b> Differential PCI Express receive pairs for port 1. When port 0 is merged with port 1, these signals become port 0 receive pairs for lanes 4 through 7.    |
| PE1TP[3:0]<br>PE1TN[3:0] | O    | <b>PCI Express Port 1 Serial Data Transmit.</b> Differential PCI Express transmit pairs for port 1. When port 0 is merged with port 1, these signals become port 0 transmit pairs for lanes 4 through 7. |
| PE2RP[3:0]<br>PE2RN[3:0] | I    | <b>PCI Express Port 2 Serial Data Receive.</b> Differential PCI Express receive pairs for port 2.  |

Table 2 PCI Express Interface Pins (Part 1 of 3)

| Signal                   | Type | Name/Description   |
|--------------------------|------|--|
| PE2TP[3:0]<br>PE2TN[3:0] | O    | <b>PCI Express Port 2 Serial Data Transmit.</b> Differential PCI Express transmit pairs for port 2.  |
| PE3RP[3:0]<br>PE3RN[3:0] | I    | <b>PCI Express Port 3 Serial Data Receive.</b> Differential PCI Express receive pairs for port 3. When port 2 is merged with port 3, these signals become port 2 receive pairs for lanes 4 through 7.    |
| PE3TP[3:0]<br>PE3TN[3:0] | O    | <b>PCI Express Port 3 Serial Data Transmit.</b> Differential PCI Express transmit pairs for port 2. When port 2 is merged with port 3, these signals become port 2 transmit pairs for lanes 4 through 7. |
| PE4RP[3:0]<br>PE4RN[3:0] | I    | <b>PCI Express Port 4 Serial Data Receive.</b> Differential PCI Express receive pairs for port 4.  |
| PE4TP[3:0]<br>PE4TN[3:0] | O    | <b>PCI Express Port 4 Serial Data Transmit.</b> Differential PCI Express transmit pairs for port 4.  |
| PE5RP[3:0]<br>PE5RN[3:0] | I    | <b>PCI Express Port 5 Serial Data Receive.</b> Differential PCI Express receive pairs for port 5. When port 4 is merged with port 5, these signals become port 4 receive pairs for lanes 4 through 7.    |
| PE5TP[3:0]<br>PE5TN[3:0] | O    | <b>PCI Express Port 5 Serial Data Transmit.</b> Differential PCI Express transmit pairs for port 5. When port 4 is merged with port 5, these signals become port 4 transmit pairs for lanes 4 through 7. |
| PE6RP[0]<br>PE6RN[0]     | I    | <b>PCI Express Port 6 Serial Data Receive.</b> Differential PCI Express receive pair for port 6.   |
| PE6TP[0]<br>PE6TN[0]     | O    | <b>PCI Express Port 6 Serial Data Transmit.</b> Differential PCI Express transmit pair for port 6.   |
| PE7RP[0]<br>PE7RN[0]     | I    | <b>PCI Express Port 7 Serial Data Receive.</b> Differential PCI Express receive pair for port 7.   |
| PE7TP[0]<br>PE7TN[0]     | O    | <b>PCI Express Port 7 Serial Data Transmit.</b> Differential PCI Express transmit pair for port 7.   |
| PE8RP[0]<br>PE8RN[0]     | I    | <b>PCI Express Port 8 Serial Data Receive.</b> Differential PCI Express receive pair for port 8.   |
| PE8TP[0]<br>PE8TN[0]     | O    | <b>PCI Express Port 8 Serial Data Transmit.</b> Differential PCI Express transmit pair for port 8.   |
| PE9RP[0]<br>PE9RN[0]     | I    | <b>PCI Express Port 9 Serial Data Receive.</b> Differential PCI Express receive pair for port 9.   |
| PE9TP[0]<br>PE9TN[0]     | O    | <b>PCI Express Port 9 Serial Data Transmit.</b> Differential PCI Express transmit pair for port 9.   |
| PE10RP[0]<br>PE10RN[0]   | I    | <b>PCI Express Port 10 Serial Data Receive.</b> Differential PCI Express receive pair for port 10.   |
| PE10TP[0]<br>PE10TN[0]   | O    | <b>PCI Express Port 10 Serial Data Transmit.</b> Differential PCI Express transmit pair for port 10.   |
| PE11RP[0]<br>PE11RN[0]   | I    | <b>PCI Express Port 11 Serial Data Receive.</b> Differential PCI Express receive pair for port 11.   |
| PE11TP[0]<br>PE11TN[0]   | O    | <b>PCI Express Port 11 Serial Data Transmit.</b> Differential PCI Express transmit pair for port 11.   |
| PE12RP[0]<br>PE12RN[0]   | I    | <b>PCI Express Port 12 Serial Data Receive.</b> Differential PCI Express receive pair for port 12.   |
| PE12TP[0]<br>PE12TN[0]   | O    | <b>PCI Express Port 12 Serial Data Transmit.</b> Differential PCI Express transmit pair for port 12.   |

Table 2 PCI Express Interface Pins (Part 2 of 3)

| Signal                           | Type | Name/Description   |
|----------------------------------|------|--|
| PE13RP[0]<br>PE13RN[0]           | I    | <b>PCI Express Port 13 Serial Data Receive.</b> Differential PCI Express receive pair for port 13.   |
| PE13TP[0]<br>PE13TN[0]           | O    | <b>PCI Express Port 13 Serial Data Transmit.</b> Differential PCI Express transmit pair for port 13. W   |
| PE14RP[0]<br>PE14RN[0]           | I    | <b>PCI Express Port 14 Serial Data Receive.</b> Differential PCI Express receive pair for port 14.   |
| PE14TP[0]<br>PE14TN[0]           | O    | <b>PCI Express Port 14 Serial Data Transmit.</b> Differential PCI Express transmit pair for port 14.   |
| PE15RP[0]<br>PE15RN[0]           | I    | <b>PCI Express Port 15 Serial Data Receive.</b> Differential PCI Express receive pair for port 15.   |
| PE15TP[0]<br>PE15TN[0]           | O    | <b>PCI Express Port 15 Serial Data Transmit.</b> Differential PCI Express transmit pair for port 15.   |
| REFCLKM                          | I    | <b>PCI Express Reference Clock Mode Select.</b> This signal selects the frequency of the reference clock input.<br>0x0 - 100 MHz<br>0x1 - 125 MHz  |
| PEREFCLKP[3:0]<br>PEREFCLKN[3:0] | I    | <b>PCI Express Reference Clock.</b> Differential reference clock pair input. This clock is used as the reference clock by on-chip PLLs to generate the clocks required for the system logic and on-chip SerDes. The frequency of the differential reference clock is determined by the REFCLKM signal. |

Table 2 PCI Express Interface Pins (Part 3 of 3)

| Signal          | Type | Name/Description   |
|-----------------|------|--|
| MSMBADDR[4:1]   | I    | <b>Master SMBus Address.</b> These pins determine the SMBus address of the serial EEPROM from which configuration information is loaded.   |
| MSMBCLK         | I/O  | <b>Master SMBus Clock.</b> This bidirectional signal is used to synchronize transfers on the master SMBus. It is active and generating the clock only when the EEPROM or I/O Expanders are being accessed. |
| MSMBDAT         | I/O  | <b>Master SMBus Data.</b> This bidirectional signal is used for data on the master SMBus.  |
| SSMBADDR[5:3:1] | I    | <b>Slave SMBus Address.</b> These pins determine the SMBus address to which the slave SMBus interface responds.  |
| SSMBCLK         | I/O  | <b>Slave SMBus Clock.</b> This bidirectional signal is used to synchronize transfers on the slave SMBus.   |
| SSMBDAT         | I/O  | <b>Slave SMBus Data.</b> This bidirectional signal is used for data on the slave SMBus.  |

Table 3 SMBus Interface Pins

| <b>Signal</b> | <b>Type</b> | <b>Name/Description</b>   |
|---------------|-------------|---|
| GPIO[0]       | I/O         | <b>General Purpose I/O.</b><br>This pin can be configured as a general purpose I/O pin.   |
| GPIO[1]       | I/O         | <b>General Purpose I/O.</b><br>This pin can be configured as a general purpose I/O pin.   |
| GPIO[2]       | I/O         | <b>General Purpose I/O.</b><br>This pin can be configured as a general purpose I/O pin.   |
| GPIO[3]       | I/O         | <b>General Purpose I/O.</b><br>This pin can be configured as a general purpose I/O pin.   |
| GPIO[4]       | I/O         | <b>General Purpose I/O.</b><br>This pin can be configured as a general purpose I/O pin.   |
| GPIO[5]       | I/O         | <b>General Purpose I/O.</b><br>This pin can be configured as a general purpose I/O pin.<br>Alternate function pin name: GPEN<br>Alternate function pin type: Output<br>Alternate function: General Purpose Event (GPE) output   |
| GPIO[6]       | I/O         | <b>General Purpose I/O.</b><br>This pin can be configured as a general purpose I/O pin.<br>Alternate function pin name: P1RSTN<br>Alternate function pin type: Output<br>Alternate function: Reset output for downstream port 1 |
| GPIO[7]       | I/O         | <b>General Purpose I/O.</b><br>This pin can be configured as a general purpose I/O pin.<br>Alternate function pin name: P2RSTN<br>Alternate function pin type: Output<br>Alternate function: Reset output for downstream port 2 |
| GPIO[8]       | I/O         | <b>General Purpose I/O.</b><br>This pin can be configured as a general purpose I/O pin.<br>Alternate function pin name: P3RSTN<br>Alternate function pin type: Output<br>Alternate function: Reset output for downstream port 3 |
| GPIO[9]       | I/O         | <b>General Purpose I/O.</b><br>This pin can be configured as a general purpose I/O pin.<br>Alternate function pin name: P4RSTN<br>Alternate function pin type: Output<br>Alternate function: Reset output for downstream port 4 |
| GPIO[10]      | I/O         | <b>General Purpose I/O.</b><br>This pin can be configured as a general purpose I/O pin.<br>Alternate function pin name: P5RSTN<br>Alternate function pin type: Output<br>Alternate function: Reset output for downstream port 5 |
| GPIO[11]      | I/O         | <b>General Purpose I/O.</b><br>This pin can be configured as a general purpose I/O pin.<br>Alternate function pin name: P6RSTN<br>Alternate function pin type: Output<br>Alternate function: Reset output for downstream port 6 |

Table 4 General Purpose I/O Pins (Part 1 of 3)

| Signal   | Type | Name/Description  |
|----------|------|---|
| GPIO[12] | I/O  | <b>General Purpose I/O.</b><br>This pin can be configured as a general purpose I/O pin.<br>Alternate function pin name: P7RSTN<br>Alternate function pin type: Output<br>Alternate function: Reset output for downstream port 7   |
| GPIO[13] | I/O  | <b>General Purpose I/O.</b><br>This pin can be configured as a general purpose I/O pin.<br>Alternate function pin name: P8RSTN<br>Alternate function pin type: Output<br>Alternate function: Reset output for downstream port 8   |
| GPIO[14] | I/O  | <b>General Purpose I/O.</b><br>This pin can be configured as a general purpose I/O pin.<br>Alternate function pin name: P9RSTN<br>Alternate function pin type: Output<br>Alternate function: Reset output for downstream port 9   |
| GPIO[15] | I/O  | <b>General Purpose I/O.</b><br>This pin can be configured as a general purpose I/O pin.<br>Alternate function pin name: P10RSTN<br>Alternate function pin type: Output<br>Alternate function: Reset output for downstream port 10 |
| GPIO[16] | I/O  | <b>General Purpose I/O.</b><br>This pin can be configured as a general purpose I/O pin.<br>Alternate function pin name: P11RSTN<br>Alternate function pin type: Output<br>Alternate function: Reset output for downstream port 11 |
| GPIO[17] | I/O  | <b>General Purpose I/O.</b><br>This pin can be configured as a general purpose I/O pin.<br>Alternate function pin name: P12RSTN<br>Alternate function pin type: Output<br>Alternate function: Reset output for downstream port 12 |
| GPIO[18] | I/O  | <b>General Purpose I/O.</b><br>This pin can be configured as a general purpose I/O pin.<br>Alternate function pin name: P13RSTN<br>Alternate function pin type: Output<br>Alternate function: Reset output for downstream port 13 |
| GPIO[19] | I/O  | <b>General Purpose I/O.</b><br>This pin can be configured as a general purpose I/O pin.<br>Alternate function pin name: P14RSTN<br>Alternate function pin type: Output<br>Alternate function: Reset output for downstream port 14 |
| GPIO[20] | I/O  | <b>General Purpose I/O.</b><br>This pin can be configured as a general purpose I/O pin.<br>Alternate function pin name: P15RSTN<br>Alternate function pin type: Output<br>Alternate function: Reset output for downstream port 15 |
| GPIO[21] | I/O  | <b>General Purpose I/O.</b><br>This pin can be configured as a general purpose I/O pin.<br>Alternate function pin name: IOEXPINTN0<br>Alternate function pin type: Input<br>Alternate function: SMBus I/O expander interrupt 0    |

Table 4 General Purpose I/O Pins (Part 2 of 3)



| Signal   | Type | Name/Description   |
|----------|------|--|
| GPIO[22] | I/O  | <b>General Purpose I/O.</b><br>This pin can be configured as a general purpose I/O pin.<br>Alternate function pin name: IOEXPINTN1<br>Alternate function pin type: Input<br>Alternate function: SMBus I/O expander interrupt 1   |
| GPIO[23] | I/O  | <b>General Purpose I/O.</b><br>This pin can be configured as a general purpose I/O pin.<br>Alternate function pin name: IOEXPINTN2<br>Alternate function pin type: Input<br>Alternate function: SMBus I/O expander interrupt 2   |
| GPIO[24] | I/O  | <b>General Purpose I/O.</b><br>This pin can be configured as a general purpose I/O pin.<br>Alternate function pin name: IOEXPINTN3<br>Alternate function pin type: Input<br>Alternate function: SMBus I/O expander interrupt 3   |
| GPIO[25] | I/O  | <b>General Purpose I/O.</b><br>This pin can be configured as a general purpose I/O pin.<br>Alternate function pin name: IOEXPINTN4<br>Alternate function pin type: Input<br>Alternate function: SMBus I/O expander interrupt 4   |
| GPIO[26] | I/O  | <b>General Purpose I/O.</b><br>This pin can be configured as a general purpose I/O pin.<br>Alternate function pin name: IOEXPINTN5<br>Alternate function pin type: Input<br>Alternate function: SMBus I/O expander interrupt 5   |
| GPIO[27] | I/O  | <b>General Purpose I/O.</b><br>This pin can be configured as a general purpose I/O pin.<br>Alternate function pin name: IOEXPINTN6<br>Alternate function pin type: Input<br>Alternate function: SMBus I/O expander interrupt 6   |
| GPIO[28] | I/O  | <b>General Purpose I/O.</b><br>This pin can be configured as a general purpose I/O pin.<br>Alternate function pin name: IOEXPINTN7<br>Alternate function pin type: Input<br>Alternate function: SMBus I/O expander interrupt 7   |
| GPIO[29] | I/O  | <b>General Purpose I/O.</b><br>This pin can be configured as a general purpose I/O pin.  |
| GPIO[30] | I/O  | <b>General Purpose I/O.</b><br>This pin can be configured as a general purpose I/O pin.  |
| GPIO[31] | I/O  | <b>General Purpose I/O.</b><br>This pin can be configured as a general purpose I/O pin.<br>Alternate function pin name: IOEXPINTN10<br>Alternate function pin type: Input<br>Alternate function: SMBus I/O expander interrupt 10 |

Table 4 General Purpose I/O Pins (Part 3 of 3)



| Signal      | Type | Name/Description  |
|-------------|------|---|
| CCLKDS      | I    | <b>Common Clock Downstream.</b> When the CCLKDS pin is asserted, it indicates that a common clock is being used between the downstream device and the downstream port.  |
| CCLKUS      | I    | <b>Common Clock Upstream.</b> When the CCLKUS pin is asserted, it indicates that a common clock is being used between the upstream device and the upstream port.  |
| MSMBSMODE   | I    | <b>Master SMBus Slow Mode.</b> The assertion of this pin indicates that the master SMBus should operate at 100 KHz instead of 400 KHz. This value may not be overridden.  |
| P01MERGEN   | I    | <b>Port 0 and 1 Merge.</b> P01MERGEN is an active low signal. It is pulled low internally via a 251K ohm resistor.<br>When this pin is low, port 0 is merged with port 1 to form a single x8 port. The Serdes lanes associated with port 1 become lanes 4 through 7 of port 0. When this pin is high, port 0 and port 1 are not merged, and each operates as a single x4 port   |
| P23MERGEN   | I    | <b>Port 2 and 3 Merge.</b> P23MERGEN is an active low signal. It is pulled low internally via a 251K ohm resistor.<br>When this pin is low, port 2 is merged with port 3 to form a single x8 port. The Serdes lanes associated with port 3 become lanes 4 through 7 of port 2. When this pin is high, port 2 and port 3 are not merged, and each operates as a single x4 port.  |
| P45MERGEN   | I    | <b>Port 4 and 5 Merge.</b> P45MERGEN is an active low signal. It is pulled low internally via a 251K ohm resistor.<br>When this pin is low, port 4 is merged with port 5 to form a single x8 port. The Serdes lanes associated with port 5 become lanes 4 through 7 of port 4. When this pin is high, port 4 and port 5 are not merged, and each operates as a single x4 port.  |
| PERSTN      | I    | <b>Fundamental Reset.</b> Assertion of this signal resets all logic inside the PES34H16 and initiates a PCI Express fundamental reset.  |
| RSTHALT     | I    | <b>Reset Halt.</b> When this signal is asserted during a PCI Express fundamental reset, the PES34H16 executes the reset procedure and remains in a reset state with the Master and Slave SMBuses active. This allows software to read and write registers internal to the device before normal device operation begins. The device exits the reset state when the RSTHALT bit is cleared in the PA_SWCTL register by an SMBus master.   |
| SWMODE[3:0] | I    | <b>Switch Mode.</b> These configuration pins determine the PES34H16 switch operating mode. These pins should be static and not change following the negation of PERSTN.<br>0x0 - Normal switch mode<br>0x1 - Normal switch mode with Serial EEPROM initialization<br>0x2 through 0x7 - Reserved<br>0x8 - Normal switch mode with upstream port failover (port 0 selected as the upstream port)<br>0x9 - Normal switch mode with upstream port failover (port 2 selected as the upstream port)<br>0xA - Normal switch mode with Serial EEPROM initialization and upstream port failover (port 0 selected as the upstream port)<br>0xB - Normal switch mode with Serial EEPROM initialization and upstream port failover (port 2 selected as the upstream port)<br>0xC through 0xF - Reserved |

Table 5 System Pins

| Signal      | Type | Name/Description   |
|-------------|------|--|
| JTAG_TCK    | I    | <b>JTAG Clock.</b> This is an input test clock used to clock the shifting of data into or out of the boundary scan logic or JTAG Controller. JTAG_TCK is independent of the system clock with a nominal 50% duty cycle.  |
| JTAG_TDI    | I    | <b>JTAG Data Input.</b> This is the serial data input to the boundary scan logic or JTAG Controller.   |
| JTAG_TDO    | O    | <b>JTAG Data Output.</b> This is the serial data shifted out from the boundary scan logic or JTAG Controller. When no data is being shifted out, this signal is tri-stated.  |
| JTAG_TMS    | I    | <b>JTAG Mode.</b> The value on this signal controls the test mode select of the boundary scan logic or JTAG Controller.  |
| JTAG_TRST_N | I    | <b>JTAG Reset.</b> This active low signal asynchronously resets the boundary scan logic and JTAG TAP Controller. An external pull-up on the board is recommended to meet the JTAG specification in cases where the tester can access this signal. However, for systems running in functional mode, one of the following should occur:<br>1) actively drive this signal low with control logic<br>2) statically drive this signal low with an external pull-down on the board |

Table 6 Test Pins

| Signal               | Type | Name/Description   |
|----------------------|------|--|
| V <sub>DD</sub> CORE | I    | <b>Core VDD.</b> Power supply for core logic.  |
| V <sub>DD</sub> I/O  | I    | <b>I/O VDD.</b> LVTTTL I/O buffer power supply.  |
| V <sub>DD</sub> PE   | I    | <b>PCI Express Digital Power.</b> PCI Express digital power used by the digital power of the SerDes.   |
| V <sub>DD</sub> APE  | I    | <b>PCI Express Analog Power.</b> PCI Express analog power used by the PLL and bias generator.  |
| V <sub>SS</sub>      | I    | Ground.  |
| V <sub>TT</sub> PE   |      | <b>PCI Express Serial Data Transmit Termination Voltage.</b> This pin allows the driver termination voltage to be set, enabling the system designer to control the Common Mode Voltage and output voltage swing of the corresponding PCI Serial Data Transmit differential pair. |

Table 7 Power and Ground Pins

## Pin Characteristics

**Note:** Some input pads of the PES34H16 do not contain internal pull-ups or pull-downs. Unused inputs should be tied off to appropriate levels. This is especially critical for unused control signal inputs which, if left floating, could adversely affect operation. Also, any input pin left floating can cause a slight increase in power consumption.

| Function              | Pin Name   | Type | Buffer | I/O Type    | Internal Resistor | Notes |
|-----------------------|------------|------|--------|-------------|-------------------|-------|
| PCI Express Interface | PE0RN[3:0] | I    | CML    | Serial Link |                   |       |
|                       | PE0RP[3:0] | I    |        |             |                   |       |
|                       | PE0TN[3:0] | O    |        |             |                   |       |
|                       | PE0TP[3:0] | O    |        |             |                   |       |
|                       | PE1RN[3:0] | I    |        |             |                   |       |
|                       | PE1RP[3:0] | I    |        |             |                   |       |
|                       | PE1TN[3:0] | O    |        |             |                   |       |
|                       | PE1TP[3:0] | O    |        |             |                   |       |
|                       | PE2RN[3:0] | I    |        |             |                   |       |
|                       | PE2RP[3:0] | I    |        |             |                   |       |
|                       | PE2TN[3:0] | O    |        |             |                   |       |
|                       | PE2TP[3:0] | O    |        |             |                   |       |
|                       | PE3RN[3:0] | I    |        |             |                   |       |
|                       | PE3RP[3:0] | I    |        |             |                   |       |
|                       | PE3TN[3:0] | O    |        |             |                   |       |
|                       | PE3TP[3:0] | O    |        |             |                   |       |
|                       | PE4RN[3:0] | I    |        |             |                   |       |
|                       | PE4RP[3:0] | I    |        |             |                   |       |
|                       | PE4TN[3:0] | O    |        |             |                   |       |
|                       | PE4TP[3:0] | O    |        |             |                   |       |
|                       | PE5RN[3:0] | I    |        |             |                   |       |
|                       | PE5RP[3:0] | I    |        |             |                   |       |
|                       | PE5TN[3:0] | O    |        |             |                   |       |
|                       | PE5TP[3:0] | O    |        |             |                   |       |
|                       | PE6RN[0]   | I    |        |             |                   |       |
|                       | PE6RP[0]   | I    |        |             |                   |       |
|                       | PE6TN[0]   | O    |        |             |                   |       |
|                       | PE6TP[0]   | O    |        |             |                   |       |
|                       | PE7RN[0]   | I    |        |             |                   |       |
|                       | PE7RP[0]   | I    |        |             |                   |       |
|                       | PE7TN[0]   | O    |        |             |                   |       |
|                       | PE7TP[0]   | O    |        |             |                   |       |
| PE8RN[0]              | I          |      |        |             |                   |       |

Table 8 Pin Characteristics (Part 1 of 3)

| Function                         | Pin Name  | Type           | Buffer | I/O Type    | Internal Resistor | Notes          |                      |  |                  |
|----------------------------------|-----------|----------------|--------|-------------|-------------------|----------------|----------------------|--|------------------|
| PCI Express Interface<br>(cont.) | PE8RP[0]  | I              | CML    | Serial Link |                   |                |                      |  |                  |
|                                  | PE8TN[0]  | O              |        |             |                   |                |                      |  |                  |
|                                  | PE8TP[0]  | O              |        |             |                   |                |                      |  |                  |
|                                  | PE9RN[0]  | I              |        |             |                   |                |                      |  |                  |
|                                  | PE9RP[0]  | I              |        |             |                   |                |                      |  |                  |
|                                  | PE9TN[0]  | O              |        |             |                   |                |                      |  |                  |
|                                  | PE9TP[0]  | O              |        |             |                   |                |                      |  |                  |
|                                  | PE10RN[0] | I              |        |             |                   |                |                      |  |                  |
|                                  | PE10RP[0] | I              |        |             |                   |                |                      |  |                  |
|                                  | PE10TN[0] | O              |        |             |                   |                |                      |  |                  |
|                                  | PE10TP[0] | O              |        |             |                   |                |                      |  |                  |
|                                  | PE11RN[0] | I              |        |             |                   |                |                      |  |                  |
|                                  | PE11RP[0] | I              |        |             |                   |                |                      |  |                  |
|                                  | PE11TN[0] | O              |        |             |                   |                |                      |  |                  |
|                                  | PE11TP[0] | O              |        |             |                   |                |                      |  |                  |
|                                  | PE12RN[0] | I              |        |             |                   |                |                      |  |                  |
|                                  | PE12RP[0] | I              |        |             |                   |                |                      |  |                  |
|                                  | PE12TN[0] | O              |        |             |                   |                |                      |  |                  |
|                                  | PE12TP[0] | O              |        |             |                   |                |                      |  |                  |
|                                  | PE13RN[0] | I              |        |             |                   |                |                      |  |                  |
|                                  | PE13RP[0] | I              |        |             |                   |                |                      |  |                  |
|                                  | PE13TN[0] | O              |        |             |                   |                |                      |  |                  |
|                                  | PE13TP[0] | O              |        |             |                   |                |                      |  |                  |
|                                  | PE14RN[0] | I              |        |             |                   |                |                      |  |                  |
|                                  | PE14RP[0] | I              |        |             |                   |                |                      |  |                  |
|                                  | PE14TN[0] | O              |        |             |                   |                |                      |  |                  |
|                                  | PE14TP[0] | O              |        |             |                   |                |                      |  |                  |
|                                  | PE15RN[0] | I              |        |             |                   |                |                      |  |                  |
|                                  | PE15RP[0] | I              |        |             |                   |                |                      |  |                  |
|                                  | PE15TN[0] | O              |        |             |                   |                |                      |  |                  |
|                                  | PE15TP[0] | O              |        |             |                   |                |                      |  |                  |
|                                  |           | PEREFCLKN[3:0] |        |             | I                 | LVPECL/<br>CML | Diff. Clock<br>Input |  | Refer to Table 9 |
|                                  |           | PEREFCLKP[3:0] |        |             | I                 |                |                      |  |                  |
|                                  | REFCLKM   | I              | LVTTTL | Input       | pull-down         |                |                      |  |                  |

Table 8 Pin Characteristics (Part 2 of 3)

| Function            | Pin Name        | Type | Buffer | I/O Type         | Internal Resistor | Notes              |
|---------------------|-----------------|------|--------|------------------|-------------------|--------------------|
| SMBus               | MSMBADDR[4:1]   | I    | LVTTL  |                  | pull-up           |                    |
|                     | MSMBCLK         | I/O  |        | STI <sup>1</sup> |                   |                    |
|                     | MSMBDAT         | I/O  |        | STI              |                   |                    |
|                     | SSMBADDR[5,3:1] | I    |        |                  | pull-up           |                    |
|                     | SSMBCLK         | I/O  |        | STI              |                   |                    |
|                     | SSMBDAT         | I/O  |        | STI              |                   |                    |
| General Purpose I/O | GPIO[31:0]      | I/O  | LVTTL  |                  | pull-up           |                    |
| System Pins         | CCLKDS          | I    | LVTTL  | Input            | pull-up           |                    |
|                     | CCLKUS          | I    |        |                  | pull-up           |                    |
|                     | MSMBSMODE       | I    |        |                  | pull-down         |                    |
|                     | P01MERGEN       | I    |        |                  | pull-down         |                    |
|                     | P23MERGEN       | I    |        |                  | pull-down         |                    |
|                     | P45MERGEN       | I    |        |                  | pull-down         |                    |
|                     | PERSTN          | I    |        |                  |                   |                    |
|                     | RSTHALT         | I    |        |                  | pull-down         |                    |
|                     | SWMODE[3:0]     | I    |        |                  | pull-down         |                    |
| EJTAG / JTAG        | JTAG_TCK        | I    | LVTTL  | STI              | pull-up           |                    |
|                     | JTAG_TDI        | I    |        | STI              | pull-up           |                    |
|                     | JTAG_TDO        | O    |        |                  |                   |                    |
|                     | JTAG_TMS        | I    |        | STI              | pull-up           |                    |
|                     | JTAG_TRST_N     | I    |        | STI              | pull-up           | External pull-down |

Table 8 Pin Characteristics (Part 3 of 3)

<sup>1</sup> Schmitt Trigger Input (STI).

# Logic Diagram — PES34H16

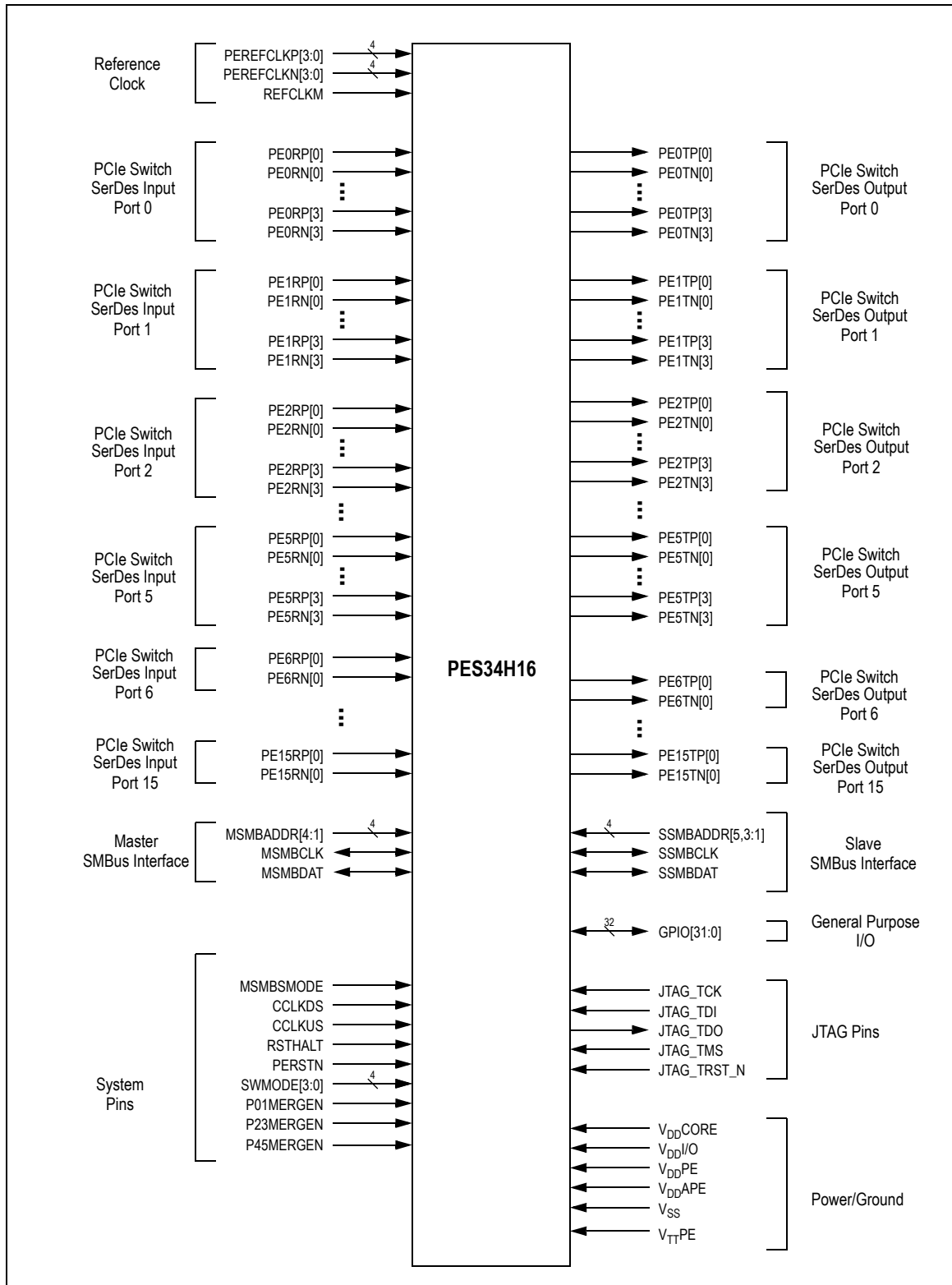

Figure 3 PES34H16 Logic Diagram

## System Clock Parameters

Values based on systems running at recommended supply voltages and operating temperatures, as shown in Tables 13 and 14.

| Parameter                         | Description                                   | Min | Typical | Max              | Unit              |
|-----------------------------------|---|-----|---------|------------------|-------------------|
| <b>PEREFCLK</b>                   |   |     |         |                  |                   |
| Refclk <sub>FREQ</sub>            | Input reference clock frequency range         | 100 |         | 125 <sup>1</sup> | MHz               |
| Refclk <sub>DC</sub> <sup>2</sup> | Duty cycle of input clock                     | 40  | 50      | 60               | %                 |
| T <sub>R</sub> , T <sub>F</sub>   | Rise/Fall time of input clocks                |     |         | 0.2*RCUI         | RCUI <sup>3</sup> |
| V <sub>SW</sub>                   | Differential input voltage swing <sup>4</sup> | 0.6 |         | 1.6              | V                 |
| T <sub>jitter</sub>               | Input clock jitter (cycle-to-cycle)           |     |         | 125              | ps                |
| R <sub>T</sub>                    | Termination Resistor                          |     | 110     |                  | Ohms              |

**Table 9 Input Clock Requirements**

<sup>1</sup> The input clock frequency will be either 100 or 125 MHz depending on signal REFCLKM.

<sup>2</sup> ClkIn must be AC coupled. Use 0.01 — 0.1  $\mu$ F ceramic capacitors.

<sup>3</sup> RCUI (Reference Clock Unit Interval) refers to the reference clock period.

<sup>4</sup> AC coupling required.

## AC Timing Characteristics

| Parameter                                   | Description  | Min <sup>1</sup> | Typical <sup>1</sup> | Max <sup>1</sup> | Units |
|---|--|------------------|----------------------|------------------|-------|
| <b>PCIe Transmit</b>                        |  |                  |                      |                  |       |
| UI  | Unit Interval  | 399.88           | 400                  | 400.12           | ps    |
| T <sub>TX-EYE</sub>                         | Minimum Tx Eye Width   | 0.7              | .9                   |                  | UI    |
| T <sub>TX-EYE-MEDIAN-to-MAX-JITTER</sub>    | Maximum time between the jitter median and maximum deviation from the median |                  |                      | 0.15             | UI    |
| T <sub>TX-RISE</sub> , T <sub>TX-FALL</sub> | D+ / D- Tx output rise/fall time   | 50               | 90                   |                  | ps    |
| T <sub>TX-IDLE-MIN</sub>                    | Minimum time in idle   | 50               |                      |                  | UI    |
| T <sub>TX-IDLE-SET-TO-IDLE</sub>            | Maximum time to transition to a valid Idle after sending an Idle ordered set |                  |                      | 20               | UI    |
| T <sub>TX-IDLE-TO-DIFF-DATA</sub>           | Maximum time to transition from valid idle to diff data                      |                  |                      | 20               | UI    |
| T <sub>TX-SKEW</sub>                        | Transmitter data skew between any 2 lanes                                    |                  | 500                  | 1300             | ps    |
| <b>PCIe Receive</b>                         |  |                  |                      |                  |       |
| UI  | Unit Interval  | 399.88           | 400                  | 400.12           | ps    |
| T <sub>RX-EYE (with jitter)</sub>           | Minimum Receiver Eye Width (jitter tolerance)                                | 0.4              |                      |                  | UI    |
| T <sub>RX-EYE-MEDIUM TO MAX JITTER</sub>    | Max time between jitter median & max deviation                               |                  |                      | 0.3              | UI    |
| T <sub>RX-IDLE-DET-DIFF-ENTER TIME</sub>    | Unexpected Idle Enter Detect Threshold Integration Time                      |                  |                      | 10               | ms    |
| T <sub>RX-SKEW</sub>                        | Lane to lane input skew  |                  |                      | 20               | ns    |

**Table 10 PCIe AC Timing Characteristics**



<sup>1</sup>. Minimum, Typical, and Maximum values meet the requirements under PCI Specification 1.1

| Signal                  | Symbol               | Reference Edge | Min | Max | Unit | Timing Diagram Reference |
|-------------------------|----------------------|----------------|-----|-----|------|--------------------------|
| <b>GPIO</b>             |                      |                |     |     |      |                          |
| GPIO[31:0] <sup>1</sup> | Tpw_13b <sup>2</sup> | None           | 50  | —   | ns   | See Figure 4.            |

**Table 11 GPIO AC Timing Characteristics**

<sup>1</sup>. GPIO signals must meet the setup and hold times if they are synchronous or the minimum pulse width if they are asynchronous.

<sup>2</sup>. The values for this symbol were determined by calculation, not by testing.

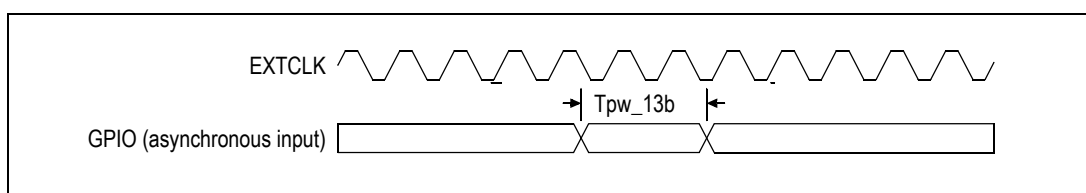

**Figure 4 GPIO AC Timing Waveform**

| Signal                           | Symbol               | Reference Edge   | Min  | Max  | Unit | Timing Diagram Reference |
|----------------------------------|----------------------|------------------|------|------|------|--------------------------|
| <b>JTAG</b>                      |                      |                  |      |      |      |                          |
| JTAG_TCK                         | Tper_16a             | none             | 50.0 | —    | ns   | See Figure 5.            |
|                                  | Thigh_16a, Tlow_16a  |                  | 10.0 | 25.0 | ns   |                          |
| JTAG_TMS <sup>1</sup> , JTAG_TDI | Tsu_16b              | JTAG_TCK rising  | 2.4  | —    | ns   |                          |
|                                  | Thld_16b             |                  | 1.0  | —    | ns   |                          |
| JTAG_TDO                         | Tdo_16c              | JTAG_TCK falling | —    | 20   | ns   |                          |
|                                  | Tdz_16c <sup>2</sup> |                  | —    | 20   | ns   |                          |
| JTAG_TRST_N                      | Tpw_16d <sup>2</sup> | none             | 25.0 | —    | ns   |                          |

**Table 12 JTAG AC Timing Characteristics**

<sup>1</sup>. The JTAG specification, IEEE 1149.1, recommends that JTAG\_TMS should be held at 1 while the signal applied at JTAG\_TRST\_N changes from 0 to 1. Otherwise, a race may occur if JTAG\_TRST\_N is deasserted (going from low to high) on a rising edge of JTAG\_TCK when JTAG\_TMS is low, because the TAP controller might go to either the Run-Test/Idle state or stay in the Test-Logic-Reset state.

<sup>2</sup>. The values for this symbol were determined by calculation, not by testing.

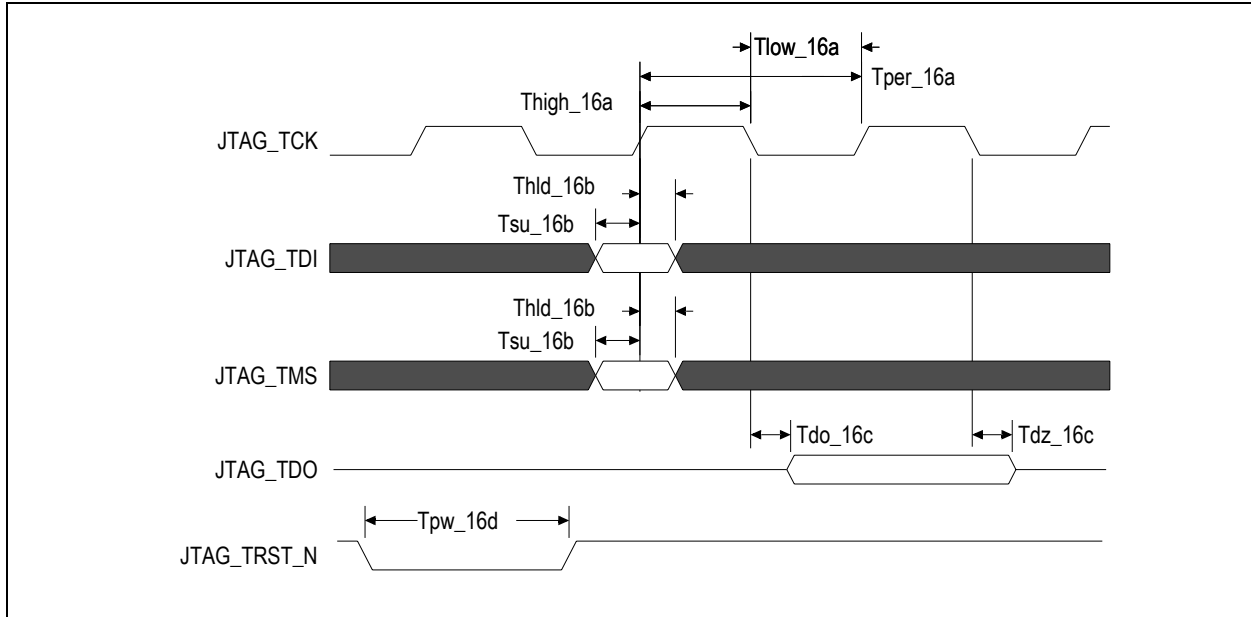

Figure 5 JTAG AC Timing Waveform

## Recommended Operating Supply Voltages

| Symbol               | Parameter  | Minimum | Typical | Maximum | Unit |
|----------------------|--|---------|---------|---------|------|
| V <sub>DD</sub> CORE | Internal logic supply                                | 0.9     | 1.0     | 1.1     | V    |
| V <sub>DD</sub> I/O  | I/O supply except for SerDes LVPECL/CML              | 3.0     | 3.3     | 3.6     | V    |
| V <sub>DD</sub> PE   | PCI Express Digital Power                            | 0.9     | 1.0     | 1.1     | V    |
| V <sub>DD</sub> APE  | PCI Express Analog Power                             | 0.9     | 1.0     | 1.1     | V    |
| V <sub>TT</sub> PE   | PCI Express Serial Data Transmit Termination Voltage | 1.425   | 1.5     | 1.575   | V    |
| V <sub>SS</sub>      | Common ground  | 0       | 0       | 0       | V    |

Table 13 PES34H16 Operating Voltages

## Power-Up Sequence

This section describes the sequence in which various voltages must be applied to the part during power-up to ensure proper functionality. For the PES34H16, the power-up sequence must be as follows:

1. V<sub>DD</sub>I/O — 3.3V
2. V<sub>DD</sub>Core, V<sub>DD</sub>PE, V<sub>DD</sub>APE — 1.0V
3. V<sub>TT</sub>PE — 1.5V

When powering up, each voltage level must ramp and stabilize prior to applying the next voltage in the sequence to ensure internal latch-up issues are avoided. There are no maximum time limitations in ramping to valid power levels. The power-down sequence must be in the reverse order of the power-up sequence.

## Recommended Operating Temperature

| Grade      | Temperature            |
|------------|------------------------|
| Commercial | 0°C to +70°C Ambient   |
| Industrial | -40°C to +85°C Ambient |

Table 14 PES34H16 Operating Temperatures

## Power Consumption

Typical power is measured under the following conditions: 25°C Ambient, 35% total link usage on all ports, typical voltages defined in Table 13 (and also listed below).

Maximum power is measured under the following conditions: 70°C Ambient, 85% total link usage on all ports, maximum voltages defined in Table 13 (and also listed below).

| Number of active Lanes per Port |       | Core Supply |          | PCIe Digital Supply |          | PCIe Analog Supply |          | PCIe Termination Supply |            | I/O Supply |          | Total     |           |
|---------------------------------|-------|-------------|----------|---------------------|----------|--------------------|----------|-------------------------|------------|------------|----------|-----------|-----------|
|                                 |       | Typ 1.0V    | Max 1.1V | Typ 1.0V            | Max 1.1V | Typ 1.0V           | Max 1.1V | Typ 1.5V                | Max 1.575V | Typ 3.3V   | Max 3.6V | Typ Power | Max Power |
| Six x4 and ten x1               | mA    | 1900        | 2364     | 1400                | 1727     | 800                | 1000     | 535                     | 762        | 5          | 5        |           |           |
|                                 | Watts | 2.3         | 3.1      | 1.8                 | 2.4      | 0.9                | 1.3      | 1.2                     | 1.7        | 0.02       | 0.02     | 6.22      | 8.52      |

Table 15 PES34H16 Power Consumption

## Thermal Considerations

This section describes thermal considerations for the PES34H16 (35X35<sup>2</sup> FCBGA1156 package). The data in Table 16 below contains information that is relevant to the thermal performance of the PES34H16 switch.

| Symbol                   | Parameter   | Value | Units | Conditions                            |
|--------------------------|---|-------|-------|---------------------------------------|
| $T_{J(max)}$             | Junction Temperature                              | 125   | °C    | Maximum                               |
| $T_{A(max)}$             | Ambient Temperature                               | 70    | °C    | Maximum for commercial-rated products |
| $\theta_{JA(effective)}$ | Effective Thermal Resistance, Junction-to-Ambient | 12.6  | °C/W  | Zero air flow                         |
|                          |   | 6.4   | °C/W  | 1 m/S air flow                        |
|                          |   | 5.4   | °C/W  | 2 m/S air flow                        |
| $\theta_{JB}$            | Thermal Resistance, Junction-to-Board             | 2.1   | °C/W  |                                       |
| $\theta_{JC}$            | Thermal Resistance, Junction-to-Case              | 0.1   | °C/W  |                                       |
| P                        | Power Dissipation of the Device                   | 6.82  | Watts | Maximum                               |

Table 16 Thermal Specifications for PES34H16, 35x35mm FCBGA1156 Package

**Note:** It is important for the reliability of this device in any user environment that the junction temperature not exceed the  $T_{J(max)}$  value specified in Table 16. Consequently, the effective junction to ambient thermal resistance ( $\theta_{JA}$ ) for the worst case scenario must be maintained below the value determined by the formula:

$$\theta_{JA} = (T_{J(max)} - T_{A(max)})/P$$

Given that the values of  $T_{J(max)}$ ,  $T_{A(max)}$ , and P are known, the value of desired  $\theta_{JA}$  becomes a known entity to the system designer. How to achieve the desired  $\theta_{JA}$  is left up to the board or system designer, but in general, it can be achieved by adding the effects of  $\theta_{JC}$  (value provided in Table 16), thermal resistance of the chosen adhesive ( $\theta_{CS}$ ), that of the heat sink ( $\theta_{SA}$ ), amount of airflow, and properties of the circuit board (number of layers and size of the board). As a general guideline, this device will not need a heat sink if the board has 10 or more layers AND the board size is larger than 4"x12" AND airflow in excess of 1 m/s is available. It is strongly recommended that users perform their own thermal analysis for their own board and system design scenarios.

## DC Electrical Characteristics

Values based on systems running at recommended supply voltages, as shown in Table 13.

**Note:** See Table 8, Pin Characteristics, for a complete I/O listing.

| I/O Type                         | Parameter                               | Description   | Min <sup>1</sup> | Typ <sup>1</sup> | Max <sup>1</sup> | Unit | Conditions |
|----------------------------------|---|---|------------------|------------------|------------------|------|------------|
| Serial Link                      | <b>PCIe Transmit</b>                    |   |                  |                  |                  |      |            |
|                                  | V <sub>TX-DIFFP-p</sub>                 | Differential peak-to-peak output voltage                | 800              |                  | 1200             | mV   |            |
|                                  | V <sub>TX-DE-RATIO</sub>                | De-emphasized differential output voltage               | -3               |                  | -4               | dB   |            |
|                                  | V <sub>TX-DC-CM</sub>                   | DC Common mode voltage                                  | -0.1             | 1                | 3.7              | V    |            |
|                                  | V <sub>TX-CM-ACP</sub>                  | RMS AC peak common mode output voltage                  |                  |                  | 20               | mV   |            |
|                                  | V <sub>TX-CM-DC-active-idle-delta</sub> | Abs delta of DC common mode voltage between L0 and idle |                  |                  | 100              | mV   |            |
|                                  | V <sub>TX-CM-DC-line-delta</sub>        | Abs delta of DC common mode voltage between D+ and D-   |                  |                  | 25               | mV   |            |
|                                  | V <sub>TX-Idle-DiffP</sub>              | Electrical idle diff peak output                        |                  |                  | 20               | mV   |            |
|                                  | V <sub>TX-RCV-Detect</sub>              | Voltage change during receiver detection                |                  |                  | 600              | mV   |            |
|                                  | RL <sub>TX-DIFF</sub>                   | Transmitter Differential Return loss                    | 12               |                  |                  | dB   |            |
|                                  | RL <sub>TX-CM</sub>                     | Transmitter Common Mode Return loss                     | 6                |                  |                  | dB   |            |
|                                  | Z <sub>TX-DEFF-DC</sub>                 | DC Differential TX impedance                            | 80               | 100              | 120              | Ω    |            |
|                                  | Z <sub>OSE</sub>                        | Single ended TX Impedance                               | 40               | 50               | 60               | Ω    |            |
|                                  | Transmitter Eye Diagram                 | TX Eye Height (De-emphasized bits)                      | 505              | 650              |                  | mV   |            |
|                                  | Transmitter Eye Diagram                 | TX Eye Height (Transition bits)                         | 800              | 950              |                  | mV   |            |
|                                  | <b>PCIe Receive</b>                     |   |                  |                  |                  |      |            |
|                                  | V <sub>RX-DIFFP-p</sub>                 | Differential input voltage (peak-to-peak)               | 175              |                  | 1200             | mV   |            |
|                                  | V <sub>RX-CM-AC</sub>                   | Receiver common-mode voltage for AC coupling            |                  |                  | 150              | mV   |            |
|                                  | RL <sub>RX-DIFF</sub>                   | Receiver Differential Return Loss                       | 15               |                  |                  | dB   |            |
|                                  | RL <sub>RX-CM</sub>                     | Receiver Common Mode Return Loss                        | 6                |                  |                  | dB   |            |
|                                  | Z <sub>RX-DIFF-DC</sub>                 | Differential input impedance (DC)                       | 80               | 100              | 120              | Ω    |            |
|                                  | Z <sub>RX-COMM-DC</sub>                 | Single-ended input impedance                            | 40               | 50               | 60               | Ω    |            |
|                                  | Z <sub>RX-COMM-HIGH-Z-DC</sub>          | Powered down input common mode impedance (DC)           | 200k             | 350k             |                  | Ω    |            |
| V <sub>RX-IDLE-DET-DIFFP-p</sub> | Electrical idle detect threshold        | 65  |                  | 175              | mV               |      |            |
| <b>PCIe REFCLK</b>               |   |   |                  |                  |                  |      |            |
|                                  | C <sub>IN</sub>                         | Input Capacitance                                       | 1.5              | —                |                  | pF   |            |

Table 17 DC Electrical Characteristics (Part 1 of 2)

| I/O Type                    | Parameter                               | Description | Min <sup>1</sup> | Typ <sup>1</sup> | Max <sup>1</sup>          | Unit | Conditions                |
|-----------------------------|---|-------------|------------------|------------------|---------------------------|------|---------------------------|
| <b>Other I/Os</b>           |   |             |                  |                  |                           |      |                           |
| LOW Drive Output            | I <sub>OL</sub>                         |             | —                | 2.5              | —                         | mA   | V <sub>OL</sub> = 0.4v    |
|                             | I <sub>OH</sub>                         |             | —                | -5.5             | —                         | mA   | V <sub>OH</sub> = 1.5V    |
| High Drive Output           | I <sub>OL</sub>                         |             | —                | 12.0             | —                         | mA   | V <sub>OL</sub> = 0.4v    |
|                             | I <sub>OH</sub>                         |             | —                | -20.0            | —                         | mA   | V <sub>OH</sub> = 1.5V    |
| Schmitt Trigger Input (STI) | V <sub>IL</sub>                         |             | -0.3             | —                | 0.8                       | V    | —                         |
|                             | V <sub>IH</sub>                         |             | 2.0              | —                | V <sub>DD</sub> I/O + 0.5 | V    | —                         |
| Input                       | V <sub>IL</sub>                         |             | -0.3             | —                | 0.8                       | V    | —                         |
|                             | V <sub>IH</sub>                         |             | 2.0              | —                | V <sub>DD</sub> I/O + 0.5 | V    | —                         |
| Capacitance                 | C <sub>IN</sub>                         |             | —                | —                | 8.5                       | pF   | —                         |
| Leakage                     | Inputs                                  |             | —                | —                | ± 10                      | μA   | V <sub>DD</sub> I/O (max) |
|                             | I/O <sub>LEAK</sub> w/o Pull-ups/downs  |             | —                | —                | ± 10                      | μA   | V <sub>DD</sub> I/O (max) |
|                             | I/O <sub>LEAK</sub> WITH Pull-ups/downs |             | —                | —                | ± 80                      | μA   | V <sub>DD</sub> I/O (max) |

Table 17 DC Electrical Characteristics (Part 2 of 2)

<sup>1</sup>: Minimum, Typical, and Maximum values meet the requirements under PCI Specification 1.0a.

**Package Pinout — 1156-BGA Signal Pinout for the PES34H16**

The following table lists the pin numbers and signal names for the PES34H16 device. Note: Pins labeled NC are No Connect.

| Pin | Function           | Alt | Pin | Function           | Alt | Pin | Function        | Alt | Pin | Function           | Alt |
|-----|--------------------|-----|-----|--------------------|-----|-----|-----------------|-----|-----|--------------------|-----|
| A1  | V <sub>SS</sub>    |     | B1  | V <sub>SS</sub>    |     | C1  | GPIO_29         |     | D1  | GPIO_28            | 1   |
| A2  | V <sub>SS</sub>    |     | B2  | V <sub>DD</sub> /O |     | C2  | GPIO_27         | 1   | D2  | GPIO_26            | 1   |
| A3  | GPIO_19            | 1   | B3  | GPIO_18            | 1   | C3  | GPIO_21         | 1   | D3  | V <sub>DD</sub> /O |     |
| A4  | V <sub>DD</sub> /O |     | B4  | GPIO_17            | 1   | C4  | GPIO_16         | 1   | D4  | GPIO_23            | 1   |
| A5  | V <sub>SS</sub>    |     | B5  | V <sub>SS</sub>    |     | C5  | V <sub>SS</sub> |     | D5  | V <sub>SS</sub>    |     |
| A6  | NC                 |     | B6  | NC                 |     | C6  | V <sub>SS</sub> |     | D6  | NC                 |     |
| A7  | NC                 |     | B7  | NC                 |     | C7  | V <sub>SS</sub> |     | D7  | NC                 |     |
| A8  | V <sub>SS</sub>    |     | B8  | V <sub>SS</sub>    |     | C8  | V <sub>SS</sub> |     | D8  | V <sub>SS</sub>    |     |
| A9  | NC                 |     | B9  | NC                 |     | C9  | V <sub>SS</sub> |     | D9  | NC                 |     |
| A10 | PE9TP00            |     | B10 | PE9TN00            |     | C10 | V <sub>SS</sub> |     | D10 | PE9RP00            |     |
| A11 | V <sub>SS</sub>    |     | B11 | V <sub>SS</sub>    |     | C11 | V <sub>SS</sub> |     | D11 | V <sub>SS</sub>    |     |
| A12 | NC                 |     | B12 | NC                 |     | C12 | V <sub>SS</sub> |     | D12 | NC                 |     |
| A13 | NC                 |     | B13 | NC                 |     | C13 | V <sub>SS</sub> |     | D13 | NC                 |     |
| A14 | V <sub>SS</sub>    |     | B14 | V <sub>SS</sub>    |     | C14 | V <sub>SS</sub> |     | D14 | V <sub>SS</sub>    |     |
| A15 | NC                 |     | B15 | NC                 |     | C15 | V <sub>SS</sub> |     | D15 | NC                 |     |
| A16 | PE8TP00            |     | B16 | PE8TN00            |     | C16 | V <sub>SS</sub> |     | D16 | PE8RP00            |     |
| A17 | V <sub>SS</sub>    |     | B17 | V <sub>SS</sub>    |     | C17 | V <sub>SS</sub> |     | D17 | V <sub>SS</sub>    |     |
| A18 | PE3TP03            |     | B18 | PE3TN03            |     | C18 | V <sub>SS</sub> |     | D18 | PE3RP03            |     |
| A19 | PE3TP02            |     | B19 | PE3TN02            |     | C19 | V <sub>SS</sub> |     | D19 | PE3RP02            |     |
| A20 | V <sub>SS</sub>    |     | B20 | V <sub>SS</sub>    |     | C20 | V <sub>SS</sub> |     | D20 | V <sub>SS</sub>    |     |
| A21 | PE3TP01            |     | B21 | PE3TN01            |     | C21 | V <sub>SS</sub> |     | D21 | PE3RP01            |     |
| A22 | PE3TP00            |     | B22 | PE3TN00            |     | C22 | V <sub>SS</sub> |     | D22 | PE3RP00            |     |
| A23 | V <sub>SS</sub>    |     | B23 | V <sub>SS</sub>    |     | C23 | V <sub>SS</sub> |     | D23 | V <sub>SS</sub>    |     |
| A24 | PE2TP03            |     | B24 | PE2TN03            |     | C24 | V <sub>SS</sub> |     | D24 | PE2RP03            |     |
| A25 | PE2TP02            |     | B25 | PE2TN02            |     | C25 | V <sub>SS</sub> |     | D25 | PE2RP02            |     |
| A26 | V <sub>SS</sub>    |     | B26 | V <sub>SS</sub>    |     | C26 | V <sub>SS</sub> |     | D26 | V <sub>SS</sub>    |     |
| A27 | PE2TP01            |     | B27 | PE2TN01            |     | C27 | V <sub>SS</sub> |     | D27 | PE2RP01            |     |
| A28 | PE2TP00            |     | B28 | PE2TN00            |     | C28 | V <sub>SS</sub> |     | D28 | PE2RP00            |     |
| A29 | V <sub>SS</sub>    |     | B29 | V <sub>SS</sub>    |     | C29 | V <sub>SS</sub> |     | D29 | V <sub>SS</sub>    |     |
| A30 | V <sub>DD</sub> /O |     | B30 | MSMBADDR_3         |     | C30 | MSMBADDR_4      |     | D30 | JTAG_TMS           |     |
| A31 | MSMBADDR_1         |     | B31 | MSMBADDR_2         |     | C31 | JTAG_TDI        |     | D31 | V <sub>DD</sub> /O |     |
| A32 | MSMBSMODE          |     | B32 | PERSTN             |     | C32 | JTAG_TRST_N     |     | D32 | SSMBADDR_5         |     |
| A33 | V <sub>SS</sub>    |     | B33 | V <sub>DD</sub> /O |     | C33 | SSMBADDR_2      |     | D33 | SSMBADDR_3         |     |
| A34 | V <sub>SS</sub>    |     | B34 | V <sub>SS</sub>    |     | C34 | SSMBADDR_1      |     | D34 | V <sub>DD</sub> /O |     |

Table 18 PES34H16 Signal Pin-Out (Part 1 of 9)



| Pin | Function            | Alt | Pin | Function        | Alt | Pin | Function        | Alt | Pin | Function            | Alt |
|-----|---------------------|-----|-----|-----------------|-----|-----|-----------------|-----|-----|---------------------|-----|
| E1  | V <sub>DD</sub> I/O |     | F1  | V <sub>SS</sub> |     | G1  | PE10TP00        |     | H1  | NC                  |     |
| E2  | GPIO_30             |     | F2  | V <sub>SS</sub> |     | G2  | PE10TN00        |     | H2  | NC                  |     |
| E3  | GPIO_31             | 1   | F3  | V <sub>SS</sub> |     | G3  | V <sub>SS</sub> |     | H3  | V <sub>SS</sub>     |     |
| E4  | GPIO_24             | 1   | F4  | V <sub>SS</sub> |     | G4  | PE10RP00        |     | H4  | NC                  |     |
| E5  | V <sub>SS</sub>     |     | F5  | V <sub>SS</sub> |     | G5  | PE10RN00        |     | H5  | NC                  |     |
| E6  | NC                  |     | F6  | V <sub>SS</sub> |     | G6  | V <sub>SS</sub> |     | H6  | V <sub>SS</sub>     |     |
| E7  | NC                  |     | F7  | V <sub>SS</sub> |     | G7  | V <sub>SS</sub> |     | H7  | V <sub>SS</sub>     |     |
| E8  | V <sub>SS</sub>     |     | F8  | V <sub>SS</sub> |     | G8  | V <sub>SS</sub> |     | H8  | GPIO_20             | 1   |
| E9  | NC                  |     | F9  | V <sub>SS</sub> |     | G9  | V <sub>SS</sub> |     | H9  | V <sub>DD</sub> I/O |     |
| E10 | PE9RN00             |     | F10 | V <sub>SS</sub> |     | G10 | V <sub>SS</sub> |     | H10 | V <sub>SS</sub>     |     |
| E11 | V <sub>SS</sub>     |     | F11 | V <sub>SS</sub> |     | G11 | V <sub>SS</sub> |     | H11 | V <sub>SS</sub>     |     |
| E12 | NC                  |     | F12 | V <sub>SS</sub> |     | G12 | V <sub>SS</sub> |     | H12 | V <sub>SS</sub>     |     |
| E13 | NC                  |     | F13 | V <sub>SS</sub> |     | G13 | V <sub>SS</sub> |     | H13 | V <sub>TT</sub> PE  |     |
| E14 | V <sub>SS</sub>     |     | F14 | V <sub>SS</sub> |     | G14 | V <sub>SS</sub> |     | H14 | V <sub>SS</sub>     |     |
| E15 | NC                  |     | F15 | V <sub>SS</sub> |     | G15 | V <sub>SS</sub> |     | H15 | V <sub>DD</sub> APE |     |
| E16 | PE8RN00             |     | F16 | V <sub>SS</sub> |     | G16 | V <sub>SS</sub> |     | H16 | V <sub>SS</sub>     |     |
| E17 | V <sub>SS</sub>     |     | F17 | V <sub>SS</sub> |     | G17 | PEREFCLKP1      |     | H17 | V <sub>SS</sub>     |     |
| E18 | PE3RN03             |     | F18 | V <sub>SS</sub> |     | G18 | PEREFCLKN1      |     | H18 | V <sub>SS</sub>     |     |
| E19 | PE3RN02             |     | F19 | V <sub>SS</sub> |     | G19 | V <sub>SS</sub> |     | H19 | V <sub>SS</sub>     |     |
| E20 | V <sub>SS</sub>     |     | F20 | V <sub>SS</sub> |     | G20 | V <sub>SS</sub> |     | H20 | V <sub>DD</sub> APE |     |
| E21 | PE3RN01             |     | F21 | V <sub>SS</sub> |     | G21 | V <sub>SS</sub> |     | H21 | V <sub>SS</sub>     |     |
| E22 | PE3RN00             |     | F22 | V <sub>SS</sub> |     | G22 | V <sub>SS</sub> |     | H22 | V <sub>TT</sub> PE  |     |
| E23 | V <sub>SS</sub>     |     | F23 | V <sub>SS</sub> |     | G23 | V <sub>SS</sub> |     | H23 | V <sub>SS</sub>     |     |
| E24 | PE2RN03             |     | F24 | V <sub>SS</sub> |     | G24 | V <sub>SS</sub> |     | H24 | V <sub>SS</sub>     |     |
| E25 | PE2RN02             |     | F25 | V <sub>SS</sub> |     | G25 | V <sub>SS</sub> |     | H25 | V <sub>SS</sub>     |     |
| E26 | V <sub>SS</sub>     |     | F26 | V <sub>SS</sub> |     | G26 | V <sub>SS</sub> |     | H26 | MSMBDAT             |     |
| E27 | PE2RN01             |     | F27 | V <sub>SS</sub> |     | G27 | MSMBCLK         |     | H27 | V <sub>DD</sub> I/O |     |
| E28 | PE2RN00             |     | F28 | V <sub>SS</sub> |     | G28 | V <sub>SS</sub> |     | H28 | SSMBCLK             |     |
| E29 | V <sub>SS</sub>     |     | F29 | V <sub>SS</sub> |     | G29 | V <sub>SS</sub> |     | H29 | V <sub>SS</sub>     |     |
| E30 | V <sub>SS</sub>     |     | F30 | PE1RN03         |     | G30 | PE1RN02         |     | H30 | V <sub>SS</sub>     |     |
| E31 | V <sub>SS</sub>     |     | F31 | PE1RP03         |     | G31 | PE1RP02         |     | H31 | V <sub>SS</sub>     |     |
| E32 | V <sub>SS</sub>     |     | F32 | V <sub>SS</sub> |     | G32 | V <sub>SS</sub> |     | H32 | V <sub>SS</sub>     |     |
| E33 | V <sub>SS</sub>     |     | F33 | PE1TN03         |     | G33 | PE1TN02         |     | H33 | V <sub>SS</sub>     |     |
| E34 | V <sub>SS</sub>     |     | F34 | PE1TP03         |     | G34 | PE1TP02         |     | H34 | V <sub>SS</sub>     |     |

Table 18 PES34H16 Signal Pin-Out (Part 2 of 9)

| Pin | Function           | Alt | Pin | Function            | Alt | Pin | Function           | Alt | Pin | Function           | Alt |
|-----|--------------------|-----|-----|---------------------|-----|-----|--------------------|-----|-----|--------------------|-----|
| J1  | V <sub>SS</sub>    |     | K1  | NC                  |     | L1  | NC                 |     | M1  | V <sub>SS</sub>    |     |
| J2  | V <sub>SS</sub>    |     | K2  | NC                  |     | L2  | NC                 |     | M2  | V <sub>SS</sub>    |     |
| J3  | V <sub>SS</sub>    |     | K3  | V <sub>SS</sub>     |     | L3  | V <sub>SS</sub>    |     | M3  | V <sub>SS</sub>    |     |
| J4  | V <sub>SS</sub>    |     | K4  | NC                  |     | L4  | NC                 |     | M4  | V <sub>SS</sub>    |     |
| J5  | V <sub>SS</sub>    |     | K5  | NC                  |     | L5  | NC                 |     | M5  | V <sub>SS</sub>    |     |
| J6  | V <sub>SS</sub>    |     | K6  | V <sub>SS</sub>     |     | L6  | V <sub>SS</sub>    |     | M6  | V <sub>SS</sub>    |     |
| J7  | V <sub>SS</sub>    |     | K7  | V <sub>SS</sub>     |     | L7  | V <sub>SS</sub>    |     | M7  | V <sub>SS</sub>    |     |
| J8  | V <sub>SS</sub>    |     | K8  | V <sub>SS</sub>     |     | L8  | V <sub>SS</sub>    |     | M8  | V <sub>SS</sub>    |     |
| J9  | GPIO_25            | 1   | K9  | V <sub>DD</sub> /O  |     | L9  | V <sub>SS</sub>    |     | M9  | V <sub>SS</sub>    |     |
| J10 | V <sub>SS</sub>    |     | K10 | GPIO_22             | 1   | L10 | V <sub>SS</sub>    |     | M10 | V <sub>SS</sub>    |     |
| J11 | V <sub>SS</sub>    |     | K11 | V <sub>SS</sub>     |     | L11 | V <sub>SS</sub>    |     | M11 | V <sub>SS</sub>    |     |
| J12 | V <sub>SS</sub>    |     | K12 | V <sub>SS</sub>     |     | L12 | V <sub>SS</sub>    |     | M12 | V <sub>SS</sub>    |     |
| J13 | V <sub>SS</sub>    |     | K13 | V <sub>TT</sub> PE  |     | L13 | V <sub>DD</sub> PE |     | M13 | V <sub>DD</sub> PE |     |
| J14 | V <sub>DD</sub> PE |     | K14 | V <sub>SS</sub>     |     | L14 | V <sub>DD</sub> PE |     | M14 | V <sub>SS</sub>    |     |
| J15 | V <sub>SS</sub>    |     | K15 | V <sub>DD</sub> APE |     | L15 | V <sub>DD</sub> PE |     | M15 | V <sub>DD</sub> PE |     |
| J16 | V <sub>SS</sub>    |     | K16 | V <sub>SS</sub>     |     | L16 | V <sub>SS</sub>    |     | M16 | V <sub>SS</sub>    |     |
| J17 | V <sub>TT</sub> PE |     | K17 | V <sub>TT</sub> PE  |     | L17 | V <sub>DD</sub> PE |     | M17 | V <sub>DD</sub> PE |     |
| J18 | V <sub>TT</sub> PE |     | K18 | V <sub>TT</sub> PE  |     | L18 | V <sub>DD</sub> PE |     | M18 | V <sub>DD</sub> PE |     |
| J19 | V <sub>SS</sub>    |     | K19 | V <sub>SS</sub>     |     | L19 | V <sub>SS</sub>    |     | M19 | V <sub>SS</sub>    |     |
| J20 | V <sub>SS</sub>    |     | K20 | V <sub>DD</sub> APE |     | L20 | V <sub>DD</sub> PE |     | M20 | V <sub>DD</sub> PE |     |
| J21 | V <sub>DD</sub> PE |     | K21 | V <sub>SS</sub>     |     | L21 | V <sub>DD</sub> PE |     | M21 | V <sub>SS</sub>    |     |
| J22 | V <sub>SS</sub>    |     | K22 | V <sub>TT</sub> PE  |     | L22 | V <sub>DD</sub> PE |     | M22 | V <sub>DD</sub> PE |     |
| J23 | V <sub>SS</sub>    |     | K23 | V <sub>SS</sub>     |     | L23 | V <sub>SS</sub>    |     | M23 | V <sub>SS</sub>    |     |
| J24 | V <sub>SS</sub>    |     | K24 | V <sub>SS</sub>     |     | L24 | V <sub>SS</sub>    |     | M24 | V <sub>SS</sub>    |     |
| J25 | JTAG_TDO           |     | K25 | CCLKDS              |     | L25 | V <sub>SS</sub>    |     | M25 | V <sub>SS</sub>    |     |
| J26 | V <sub>DD</sub> /O |     | K26 | JTAG_TCK            |     | L26 | V <sub>SS</sub>    |     | M26 | V <sub>SS</sub>    |     |
| J27 | SSMBDAT            |     | K27 | V <sub>SS</sub>     |     | L27 | V <sub>SS</sub>    |     | M27 | V <sub>SS</sub>    |     |
| J28 | V <sub>SS</sub>    |     | K28 | V <sub>SS</sub>     |     | L28 | V <sub>SS</sub>    |     | M28 | V <sub>SS</sub>    |     |
| J29 | V <sub>SS</sub>    |     | K29 | V <sub>SS</sub>     |     | L29 | V <sub>SS</sub>    |     | M29 | V <sub>SS</sub>    |     |
| J30 | PE1RN01            |     | K30 | PE1RN00             |     | L30 | V <sub>SS</sub>    |     | M30 | PE0RN03            |     |
| J31 | PE1RP01            |     | K31 | PE1RP00             |     | L31 | V <sub>SS</sub>    |     | M31 | PE0RP03            |     |
| J32 | V <sub>SS</sub>    |     | K32 | V <sub>SS</sub>     |     | L32 | V <sub>SS</sub>    |     | M32 | V <sub>SS</sub>    |     |
| J33 | PE1TN01            |     | K33 | PE1TN00             |     | L33 | V <sub>SS</sub>    |     | M33 | PE0TN03            |     |
| J34 | PE1TP01            |     | K34 | PE1TP00             |     | L34 | V <sub>SS</sub>    |     | M34 | PE0TP03            |     |

Table 18 PES34H16 Signal Pin-Out (Part 3 of 9)

| Pin | Function             | Alt | Pin | Function             | Alt | Pin | Function             | Alt | Pin | Function             | Alt |
|-----|----------------------|-----|-----|----------------------|-----|-----|----------------------|-----|-----|----------------------|-----|
| N1  | PE11TP00             |     | P1  | NC                   |     | R1  | V <sub>SS</sub>      |     | T1  | NC                   |     |
| N2  | PE11TN00             |     | P2  | NC                   |     | R2  | V <sub>SS</sub>      |     | T2  | NC                   |     |
| N3  | V <sub>SS</sub>      |     | P3  | V <sub>SS</sub>      |     | R3  | V <sub>SS</sub>      |     | T3  | V <sub>SS</sub>      |     |
| N4  | PE11RP00             |     | P4  | NC                   |     | R4  | V <sub>SS</sub>      |     | T4  | NC                   |     |
| N5  | PE11RN00             |     | P5  | NC                   |     | R5  | V <sub>SS</sub>      |     | T5  | NC                   |     |
| N6  | V <sub>SS</sub>      |     | P6  | V <sub>SS</sub>      |     | R6  | V <sub>SS</sub>      |     | T6  | V <sub>SS</sub>      |     |
| N7  | V <sub>SS</sub>      |     | P7  | V <sub>SS</sub>      |     | R7  | V <sub>SS</sub>      |     | T7  | V <sub>SS</sub>      |     |
| N8  | V <sub>TT</sub> PE   |     | P8  | V <sub>SS</sub>      |     | R8  | V <sub>DD</sub> APE  |     | T8  | V <sub>SS</sub>      |     |
| N9  | V <sub>SS</sub>      |     | P9  | V <sub>DD</sub> PE   |     | R9  | V <sub>SS</sub>      |     | T9  | V <sub>SS</sub>      |     |
| N10 | V <sub>TT</sub> PE   |     | P10 | V <sub>SS</sub>      |     | R10 | V <sub>DD</sub> APE  |     | T10 | V <sub>SS</sub>      |     |
| N11 | V <sub>DD</sub> PE   |     | P11 | V <sub>DD</sub> PE   |     | R11 | V <sub>DD</sub> PE   |     | T11 | V <sub>SS</sub>      |     |
| N12 | V <sub>DD</sub> PE   |     | P12 | V <sub>SS</sub>      |     | R12 | V <sub>DD</sub> PE   |     | T12 | V <sub>SS</sub>      |     |
| N13 | V <sub>DD</sub> CORE |     | P13 | V <sub>DD</sub> CORE |     | R13 | V <sub>DD</sub> CORE |     | T13 | V <sub>SS</sub>      |     |
| N14 | V <sub>DD</sub> CORE |     | P14 | V <sub>SS</sub>      |     | R14 | V <sub>DD</sub> CORE |     | T14 | V <sub>SS</sub>      |     |
| N15 | V <sub>DD</sub> CORE |     | P15 | V <sub>DD</sub> CORE |     | R15 | V <sub>SS</sub>      |     | T15 | V <sub>DD</sub> CORE |     |
| N16 | V <sub>SS</sub>      |     | P16 | V <sub>SS</sub>      |     | R16 | V <sub>DD</sub> CORE |     | T16 | V <sub>SS</sub>      |     |
| N17 | V <sub>DD</sub> CORE |     | P17 | V <sub>DD</sub> CORE |     | R17 | V <sub>SS</sub>      |     | T17 | V <sub>DD</sub> CORE |     |
| N18 | V <sub>SS</sub>      |     | P18 | V <sub>SS</sub>      |     | R18 | V <sub>DD</sub> CORE |     | T18 | V <sub>SS</sub>      |     |
| N19 | V <sub>DD</sub> CORE |     | P19 | V <sub>DD</sub> CORE |     | R19 | V <sub>SS</sub>      |     | T19 | V <sub>DD</sub> CORE |     |
| N20 | V <sub>DD</sub> CORE |     | P20 | V <sub>SS</sub>      |     | R20 | V <sub>DD</sub> CORE |     | T20 | V <sub>SS</sub>      |     |
| N21 | V <sub>DD</sub> CORE |     | P21 | V <sub>DD</sub> CORE |     | R21 | V <sub>SS</sub>      |     | T21 | V <sub>DD</sub> CORE |     |
| N22 | V <sub>DD</sub> CORE |     | P22 | V <sub>DD</sub> CORE |     | R22 | V <sub>DD</sub> CORE |     | T22 | V <sub>DD</sub> CORE |     |
| N23 | V <sub>DD</sub> PE   |     | P23 | V <sub>SS</sub>      |     | R23 | V <sub>DD</sub> PE   |     | T23 | V <sub>SS</sub>      |     |
| N24 | V <sub>DD</sub> PE   |     | P24 | V <sub>DD</sub> PE   |     | R24 | V <sub>DD</sub> PE   |     | T24 | V <sub>SS</sub>      |     |
| N25 | V <sub>TT</sub> PE   |     | P25 | V <sub>SS</sub>      |     | R25 | V <sub>DD</sub> APE  |     | T25 | V <sub>SS</sub>      |     |
| N26 | V <sub>SS</sub>      |     | P26 | V <sub>DD</sub> PE   |     | R26 | V <sub>SS</sub>      |     | T26 | V <sub>SS</sub>      |     |
| N27 | V <sub>TT</sub> PE   |     | P27 | V <sub>SS</sub>      |     | R27 | V <sub>DD</sub> APE  |     | T27 | V <sub>SS</sub>      |     |
| N28 | V <sub>SS</sub>      |     | P28 | V <sub>SS</sub>      |     | R28 | V <sub>SS</sub>      |     | T28 | V <sub>SS</sub>      |     |
| N29 | V <sub>SS</sub>      |     | P29 | V <sub>SS</sub>      |     | R29 | V <sub>SS</sub>      |     | T29 | V <sub>SS</sub>      |     |
| N30 | PE0RN02              |     | P30 | V <sub>SS</sub>      |     | R30 | PE0RN01              |     | T30 | PE0RN00              |     |
| N31 | PE0RP02              |     | P31 | V <sub>SS</sub>      |     | R31 | PE0RP01              |     | T31 | PE0RP00              |     |
| N32 | V <sub>SS</sub>      |     | P32 | V <sub>SS</sub>      |     | R32 | V <sub>SS</sub>      |     | T32 | V <sub>SS</sub>      |     |
| N33 | PE0TN02              |     | P33 | V <sub>SS</sub>      |     | R33 | PE0TN01              |     | T33 | PE0TN00              |     |
| N34 | PE0TP02              |     | P34 | V <sub>SS</sub>      |     | R34 | PE0TP01              |     | T34 | PE0TP00              |     |

Table 18 PES34H16 Signal Pin-Out (Part 4 of 9)

| Pin | Function             | Alt | Pin | Function             | Alt | Pin | Function             | Alt | Pin | Function             | Alt |
|-----|----------------------|-----|-----|----------------------|-----|-----|----------------------|-----|-----|----------------------|-----|
| U1  | NC                   |     | V1  | V <sub>SS</sub>      |     | W1  | PE4TP00              |     | Y1  | PE4TP01              |     |
| U2  | NC                   |     | V2  | V <sub>SS</sub>      |     | W2  | PE4TN00              |     | Y2  | PE4TN01              |     |
| U3  | V <sub>SS</sub>      |     | V3  | V <sub>SS</sub>      |     | W3  | V <sub>SS</sub>      |     | Y3  | V <sub>SS</sub>      |     |
| U4  | NC                   |     | V4  | V <sub>SS</sub>      |     | W4  | PE4RP00              |     | Y4  | PE4RP01              |     |
| U5  | NC                   |     | V5  | V <sub>SS</sub>      |     | W5  | PE4RN00              |     | Y5  | PE4RN01              |     |
| U6  | V <sub>SS</sub>      |     | V6  | V <sub>SS</sub>      |     | W6  | V <sub>SS</sub>      |     | Y6  | V <sub>SS</sub>      |     |
| U7  | PEREFCLKN2           |     | V7  | PEREFCLKP2           |     | W7  | V <sub>SS</sub>      |     | Y7  | V <sub>SS</sub>      |     |
| U8  | V <sub>SS</sub>      |     | V8  | V <sub>SS</sub>      |     | W8  | V <sub>SS</sub>      |     | Y8  | V <sub>DD</sub> APE  |     |
| U9  | V <sub>TT</sub> PE   |     | V9  | V <sub>TT</sub> PE   |     | W9  | V <sub>SS</sub>      |     | Y9  | V <sub>SS</sub>      |     |
| U10 | V <sub>TT</sub> PE   |     | V10 | V <sub>TT</sub> PE   |     | W10 | V <sub>SS</sub>      |     | Y10 | V <sub>DD</sub> APE  |     |
| U11 | V <sub>DD</sub> PE   |     | V11 | V <sub>DD</sub> PE   |     | W11 | V <sub>SS</sub>      |     | Y11 | V <sub>DD</sub> PE   |     |
| U12 | V <sub>DD</sub> PE   |     | V12 | V <sub>DD</sub> PE   |     | W12 | V <sub>SS</sub>      |     | Y12 | V <sub>DD</sub> PE   |     |
| U13 | V <sub>DD</sub> CORE |     | V13 | V <sub>SS</sub>      |     | W13 | V <sub>DD</sub> CORE |     | Y13 | V <sub>DD</sub> CORE |     |
| U14 | V <sub>DD</sub> CORE |     | V14 | V <sub>SS</sub>      |     | W14 | V <sub>DD</sub> CORE |     | Y14 | V <sub>SS</sub>      |     |
| U15 | V <sub>SS</sub>      |     | V15 | V <sub>DD</sub> CORE |     | W15 | V <sub>SS</sub>      |     | Y15 | V <sub>DD</sub> CORE |     |
| U16 | V <sub>DD</sub> CORE |     | V16 | V <sub>SS</sub>      |     | W16 | V <sub>DD</sub> CORE |     | Y16 | V <sub>SS</sub>      |     |
| U17 | V <sub>SS</sub>      |     | V17 | V <sub>DD</sub> CORE |     | W17 | V <sub>SS</sub>      |     | Y17 | V <sub>DD</sub> CORE |     |
| U18 | V <sub>DD</sub> CORE |     | V18 | V <sub>SS</sub>      |     | W18 | V <sub>DD</sub> CORE |     | Y18 | V <sub>SS</sub>      |     |
| U19 | V <sub>SS</sub>      |     | V19 | V <sub>DD</sub> CORE |     | W19 | V <sub>SS</sub>      |     | Y19 | V <sub>DD</sub> CORE |     |
| U20 | V <sub>DD</sub> CORE |     | V20 | V <sub>SS</sub>      |     | W20 | V <sub>DD</sub> CORE |     | Y20 | V <sub>SS</sub>      |     |
| U21 | V <sub>SS</sub>      |     | V21 | V <sub>DD</sub> CORE |     | W21 | V <sub>SS</sub>      |     | Y21 | V <sub>DD</sub> CORE |     |
| U22 | V <sub>SS</sub>      |     | V22 | V <sub>DD</sub> CORE |     | W22 | V <sub>SS</sub>      |     | Y22 | V <sub>DD</sub> CORE |     |
| U23 | V <sub>DD</sub> PE   |     | V23 | V <sub>DD</sub> PE   |     | W23 | V <sub>SS</sub>      |     | Y23 | V <sub>DD</sub> PE   |     |
| U24 | V <sub>DD</sub> PE   |     | V24 | V <sub>DD</sub> PE   |     | W24 | V <sub>SS</sub>      |     | Y24 | V <sub>DD</sub> PE   |     |
| U25 | V <sub>TT</sub> PE   |     | V25 | V <sub>TT</sub> PE   |     | W25 | V <sub>SS</sub>      |     | Y25 | V <sub>DD</sub> APE  |     |
| U26 | V <sub>TT</sub> PE   |     | V26 | V <sub>TT</sub> PE   |     | W26 | V <sub>SS</sub>      |     | Y26 | V <sub>SS</sub>      |     |
| U27 | V <sub>SS</sub>      |     | V27 | V <sub>SS</sub>      |     | W27 | V <sub>SS</sub>      |     | Y27 | V <sub>DD</sub> APE  |     |
| U28 | PEREFCLKP0           |     | V28 | PEREFCLKN0           |     | W28 | V <sub>SS</sub>      |     | Y28 | V <sub>SS</sub>      |     |
| U29 | V <sub>SS</sub>      |     | V29 | V <sub>SS</sub>      |     | W29 | V <sub>SS</sub>      |     | Y29 | V <sub>SS</sub>      |     |
| U30 | V <sub>SS</sub>      |     | V30 | NC                   |     | W30 | NC                   |     | Y30 | V <sub>SS</sub>      |     |
| U31 | V <sub>SS</sub>      |     | V31 | NC                   |     | W31 | NC                   |     | Y31 | V <sub>SS</sub>      |     |
| U32 | V <sub>SS</sub>      |     | V32 | V <sub>SS</sub>      |     | W32 | V <sub>SS</sub>      |     | Y32 | V <sub>SS</sub>      |     |
| U33 | V <sub>SS</sub>      |     | V33 | NC                   |     | W33 | NC                   |     | Y33 | V <sub>SS</sub>      |     |
| U34 | V <sub>SS</sub>      |     | V34 | NC                   |     | W34 | NC                   |     | Y34 | V <sub>SS</sub>      |     |

Table 18 PES34H16 Signal Pin-Out (Part 5 of 9)

| Pin  | Function             | Alt | Pin  | Function             | Alt | Pin  | Function           | Alt | Pin  | Function           | Alt |
|------|----------------------|-----|------|----------------------|-----|------|--------------------|-----|------|--------------------|-----|
| AA1  | V <sub>SS</sub>      |     | AB1  | PE4TP02              |     | AC1  | PE4TP03            |     | AD1  | V <sub>SS</sub>    |     |
| AA2  | V <sub>SS</sub>      |     | AB2  | PE4TN02              |     | AC2  | PE4TN03            |     | AD2  | V <sub>SS</sub>    |     |
| AA3  | V <sub>SS</sub>      |     | AB3  | V <sub>SS</sub>      |     | AC3  | V <sub>SS</sub>    |     | AD3  | V <sub>SS</sub>    |     |
| AA4  | V <sub>SS</sub>      |     | AB4  | PE4RP02              |     | AC4  | PE4RP03            |     | AD4  | V <sub>SS</sub>    |     |
| AA5  | V <sub>SS</sub>      |     | AB5  | PE4RN02              |     | AC5  | PE4RN03            |     | AD5  | V <sub>SS</sub>    |     |
| AA6  | V <sub>SS</sub>      |     | AB6  | V <sub>SS</sub>      |     | AC6  | V <sub>SS</sub>    |     | AD6  | V <sub>SS</sub>    |     |
| AA7  | V <sub>SS</sub>      |     | AB7  | V <sub>SS</sub>      |     | AC7  | V <sub>SS</sub>    |     | AD7  | V <sub>SS</sub>    |     |
| AA8  | V <sub>SS</sub>      |     | AB8  | V <sub>TT</sub> PE   |     | AC8  | V <sub>SS</sub>    |     | AD8  | V <sub>SS</sub>    |     |
| AA9  | V <sub>DD</sub> PE   |     | AB9  | V <sub>SS</sub>      |     | AC9  | V <sub>SS</sub>    |     | AD9  | V <sub>SS</sub>    |     |
| AA10 | V <sub>SS</sub>      |     | AB10 | V <sub>TT</sub> PE   |     | AC10 | V <sub>SS</sub>    |     | AD10 | V <sub>SS</sub>    |     |
| AA11 | V <sub>DD</sub> PE   |     | AB11 | V <sub>DD</sub> PE   |     | AC11 | V <sub>SS</sub>    |     | AD11 | V <sub>SS</sub>    |     |
| AA12 | V <sub>SS</sub>      |     | AB12 | V <sub>DD</sub> PE   |     | AC12 | V <sub>SS</sub>    |     | AD12 | V <sub>SS</sub>    |     |
| AA13 | V <sub>DD</sub> CORE |     | AB13 | V <sub>DD</sub> CORE |     | AC13 | V <sub>DD</sub> PE |     | AD13 | V <sub>DD</sub> PE |     |
| AA14 | V <sub>DD</sub> CORE |     | AB14 | V <sub>DD</sub> CORE |     | AC14 | V <sub>SS</sub>    |     | AD14 | V <sub>DD</sub> PE |     |
| AA15 | V <sub>SS</sub>      |     | AB15 | V <sub>DD</sub> CORE |     | AC15 | V <sub>DD</sub> PE |     | AD15 | V <sub>DD</sub> PE |     |
| AA16 | V <sub>DD</sub> CORE |     | AB16 | V <sub>DD</sub> CORE |     | AC16 | V <sub>SS</sub>    |     | AD16 | V <sub>SS</sub>    |     |
| AA17 | V <sub>SS</sub>      |     | AB17 | V <sub>SS</sub>      |     | AC17 | V <sub>DD</sub> PE |     | AD17 | V <sub>DD</sub> PE |     |
| AA18 | V <sub>DD</sub> CORE |     | AB18 | V <sub>DD</sub> CORE |     | AC18 | V <sub>DD</sub> PE |     | AD18 | V <sub>DD</sub> PE |     |
| AA19 | V <sub>SS</sub>      |     | AB19 | V <sub>SS</sub>      |     | AC19 | V <sub>SS</sub>    |     | AD19 | V <sub>SS</sub>    |     |
| AA20 | V <sub>DD</sub> CORE |     | AB20 | V <sub>DD</sub> CORE |     | AC20 | V <sub>DD</sub> PE |     | AD20 | V <sub>DD</sub> PE |     |
| AA21 | V <sub>SS</sub>      |     | AB21 | V <sub>DD</sub> CORE |     | AC21 | V <sub>SS</sub>    |     | AD21 | V <sub>DD</sub> PE |     |
| AA22 | V <sub>DD</sub> CORE |     | AB22 | V <sub>DD</sub> CORE |     | AC22 | V <sub>DD</sub> PE |     | AD22 | V <sub>DD</sub> PE |     |
| AA23 | V <sub>SS</sub>      |     | AB23 | V <sub>DD</sub> PE   |     | AC23 | V <sub>SS</sub>    |     | AD23 | V <sub>SS</sub>    |     |
| AA24 | V <sub>DD</sub> PE   |     | AB24 | V <sub>DD</sub> PE   |     | AC24 | V <sub>SS</sub>    |     | AD24 | V <sub>SS</sub>    |     |
| AA25 | V <sub>SS</sub>      |     | AB25 | V <sub>TT</sub> PE   |     | AC25 | V <sub>SS</sub>    |     | AD25 | V <sub>SS</sub>    |     |
| AA26 | V <sub>DD</sub> PE   |     | AB26 | V <sub>SS</sub>      |     | AC26 | V <sub>SS</sub>    |     | AD26 | V <sub>SS</sub>    |     |
| AA27 | V <sub>SS</sub>      |     | AB27 | V <sub>TT</sub> PE   |     | AC27 | V <sub>SS</sub>    |     | AD27 | V <sub>SS</sub>    |     |
| AA28 | V <sub>SS</sub>      |     | AB28 | V <sub>SS</sub>      |     | AC28 | V <sub>SS</sub>    |     | AD28 | V <sub>SS</sub>    |     |
| AA29 | V <sub>SS</sub>      |     | AB29 | V <sub>SS</sub>      |     | AC29 | V <sub>SS</sub>    |     | AD29 | V <sub>SS</sub>    |     |
| AA30 | NC                   |     | AB30 | PE15RN00             |     | AC30 | V <sub>SS</sub>    |     | AD30 | NC                 |     |
| AA31 | NC                   |     | AB31 | PE15RP00             |     | AC31 | V <sub>SS</sub>    |     | AD31 | NC                 |     |
| AA32 | V <sub>SS</sub>      |     | AB32 | V <sub>SS</sub>      |     | AC32 | V <sub>SS</sub>    |     | AD32 | V <sub>SS</sub>    |     |
| AA33 | NC                   |     | AB33 | PE15TN00             |     | AC33 | V <sub>SS</sub>    |     | AD33 | NC                 |     |
| AA34 | NC                   |     | AB34 | PE15TP00             |     | AC34 | V <sub>SS</sub>    |     | AD34 | NC                 |     |

Table 18 PES34H16 Signal Pin-Out (Part 6 of 9)

| Pin  | Function            | Alt | Pin  | Function           | Alt | Pin  | Function            | Alt | Pin  | Function        | Alt |
|------|---------------------|-----|------|--------------------|-----|------|---------------------|-----|------|-----------------|-----|
| AE1  | PE5TP00             |     | AF1  | PE5TP01            |     | AG1  | V <sub>SS</sub>     |     | AH1  | PE5TP02         |     |
| AE2  | PE5TN00             |     | AF2  | PE5TN01            |     | AG2  | V <sub>SS</sub>     |     | AH2  | PE5TN02         |     |
| AE3  | V <sub>SS</sub>     |     | AF3  | V <sub>SS</sub>    |     | AG3  | V <sub>SS</sub>     |     | AH3  | V <sub>SS</sub> |     |
| AE4  | PE5RP00             |     | AF4  | PE5RP01            |     | AG4  | V <sub>SS</sub>     |     | AH4  | PE5RP02         |     |
| AE5  | PE5RN00             |     | AF5  | PE5RN01            |     | AG5  | V <sub>SS</sub>     |     | AH5  | PE5RN02         |     |
| AE6  | V <sub>SS</sub>     |     | AF6  | V <sub>SS</sub>    |     | AG6  | V <sub>SS</sub>     |     | AH6  | V <sub>SS</sub> |     |
| AE7  | V <sub>SS</sub>     |     | AF7  | V <sub>SS</sub>    |     | AG7  | CCLKUS              |     | AH7  | V <sub>SS</sub> |     |
| AE8  | V <sub>SS</sub>     |     | AF8  | V <sub>SS</sub>    |     | AG8  | V <sub>DD</sub> /O  |     | AH8  | REFCLKM         |     |
| AE9  | V <sub>DD</sub> /O  |     | AF9  | V <sub>DD</sub> /O |     | AG9  | V <sub>SS</sub>     |     | AH9  | V <sub>SS</sub> |     |
| AE10 | V <sub>SS</sub>     |     | AF10 | V <sub>DD</sub> /O |     | AG10 | V <sub>SS</sub>     |     | AH10 | V <sub>SS</sub> |     |
| AE11 | V <sub>SS</sub>     |     | AF11 | V <sub>SS</sub>    |     | AG11 | V <sub>SS</sub>     |     | AH11 | V <sub>SS</sub> |     |
| AE12 | V <sub>SS</sub>     |     | AF12 | V <sub>SS</sub>    |     | AG12 | V <sub>SS</sub>     |     | AH12 | V <sub>SS</sub> |     |
| AE13 | V <sub>TT</sub> PE  |     | AF13 | V <sub>SS</sub>    |     | AG13 | V <sub>TT</sub> PE  |     | AH13 | V <sub>SS</sub> |     |
| AE14 | V <sub>SS</sub>     |     | AF14 | V <sub>DD</sub> PE |     | AG14 | V <sub>SS</sub>     |     | AH14 | V <sub>SS</sub> |     |
| AE15 | V <sub>DD</sub> APE |     | AF15 | V <sub>SS</sub>    |     | AG15 | V <sub>DD</sub> APE |     | AH15 | V <sub>SS</sub> |     |
| AE16 | V <sub>SS</sub>     |     | AF16 | V <sub>SS</sub>    |     | AG16 | V <sub>SS</sub>     |     | AH16 | V <sub>SS</sub> |     |
| AE17 | V <sub>TT</sub> PE  |     | AF17 | V <sub>TT</sub> PE |     | AG17 | V <sub>SS</sub>     |     | AH17 | PEREFCLKN3      |     |
| AE18 | V <sub>TT</sub> PE  |     | AF18 | V <sub>TT</sub> PE |     | AG18 | V <sub>SS</sub>     |     | AH18 | PEREFCLKP3      |     |
| AE19 | V <sub>SS</sub>     |     | AF19 | V <sub>SS</sub>    |     | AG19 | V <sub>SS</sub>     |     | AH19 | V <sub>SS</sub> |     |
| AE20 | V <sub>DD</sub> APE |     | AF20 | V <sub>SS</sub>    |     | AG20 | V <sub>DD</sub> APE |     | AH20 | V <sub>SS</sub> |     |
| AE21 | V <sub>SS</sub>     |     | AF21 | V <sub>DD</sub> PE |     | AG21 | V <sub>SS</sub>     |     | AH21 | V <sub>SS</sub> |     |
| AE22 | V <sub>TT</sub> PE  |     | AF22 | V <sub>SS</sub>    |     | AG22 | V <sub>TT</sub> PE  |     | AH22 | V <sub>SS</sub> |     |
| AE23 | V <sub>SS</sub>     |     | AF23 | V <sub>SS</sub>    |     | AG23 | V <sub>SS</sub>     |     | AH23 | V <sub>SS</sub> |     |
| AE24 | V <sub>SS</sub>     |     | AF24 | V <sub>SS</sub>    |     | AG24 | V <sub>SS</sub>     |     | AH24 | V <sub>SS</sub> |     |
| AE25 | GPIO_06             | 1   | AF25 | V <sub>SS</sub>    |     | AG25 | V <sub>SS</sub>     |     | AH25 | V <sub>SS</sub> |     |
| AE26 | V <sub>DD</sub> /O  |     | AF26 | GPIO_09            | 1   | AG26 | V <sub>DD</sub> /O  |     | AH26 | V <sub>SS</sub> |     |
| AE27 | V <sub>SS</sub>     |     | AF27 | V <sub>SS</sub>    |     | AG27 | GPIO_04             |     | AH27 | V <sub>SS</sub> |     |
| AE28 | V <sub>SS</sub>     |     | AF28 | V <sub>SS</sub>    |     | AG28 | V <sub>SS</sub>     |     | AH28 | V <sub>SS</sub> |     |
| AE29 | V <sub>SS</sub>     |     | AF29 | V <sub>SS</sub>    |     | AG29 | V <sub>SS</sub>     |     | AH29 | V <sub>SS</sub> |     |
| AE30 | NC                  |     | AF30 | V <sub>SS</sub>    |     | AG30 | NC                  |     | AH30 | PE14RN00        |     |
| AE31 | NC                  |     | AF31 | V <sub>SS</sub>    |     | AG31 | NC                  |     | AH31 | PE14RP00        |     |
| AE32 | V <sub>SS</sub>     |     | AF32 | V <sub>SS</sub>    |     | AG32 | V <sub>SS</sub>     |     | AH32 | V <sub>SS</sub> |     |
| AE33 | NC                  |     | AF33 | V <sub>SS</sub>    |     | AG33 | NC                  |     | AH33 | PE14TN00        |     |
| AE34 | NC                  |     | AF34 | V <sub>SS</sub>    |     | AG34 | NC                  |     | AH34 | PE14TP00        |     |

Table 18 PES34H16 Signal Pin-Out (Part 7 of 9)

| Pin  | Function        | Alt | Pin  | Function            | Alt | Pin  | Function            | Alt | Pin  | Function            | Alt |
|------|-----------------|-----|------|---------------------|-----|------|---------------------|-----|------|---------------------|-----|
| AJ1  | PE5TP03         |     | AK1  | V <sub>SS</sub>     |     | AL1  | V <sub>DD</sub> I/O |     | AM1  | P23MERGEN           |     |
| AJ2  | PE5TN03         |     | AK2  | V <sub>SS</sub>     |     | AL2  | P01MERGEN           |     | AM2  | V <sub>DD</sub> I/O |     |
| AJ3  | V <sub>SS</sub> |     | AK3  | V <sub>SS</sub>     |     | AL3  | P45MERGEN           |     | AM3  | V <sub>DD</sub> I/O |     |
| AJ4  | PE5RP03         |     | AK4  | V <sub>SS</sub>     |     | AL4  | V <sub>DD</sub> I/O |     | AM4  | V <sub>DD</sub> I/O |     |
| AJ5  | PE5RN03         |     | AK5  | V <sub>SS</sub>     |     | AL5  | V <sub>DD</sub> I/O |     | AM5  | SWMODE_3            |     |
| AJ6  | V <sub>SS</sub> |     | AK6  | V <sub>SS</sub>     |     | AL6  | V <sub>SS</sub>     |     | AM6  | V <sub>SS</sub>     |     |
| AJ7  | V <sub>SS</sub> |     | AK7  | PE6RN00             |     | AL7  | PE6RP00             |     | AM7  | V <sub>SS</sub>     |     |
| AJ8  | V <sub>SS</sub> |     | AK8  | NC                  |     | AL8  | NC                  |     | AM8  | V <sub>SS</sub>     |     |
| AJ9  | V <sub>SS</sub> |     | AK9  | V <sub>SS</sub>     |     | AL9  | V <sub>SS</sub>     |     | AM9  | V <sub>SS</sub>     |     |
| AJ10 | V <sub>SS</sub> |     | AK10 | NC                  |     | AL10 | NC                  |     | AM10 | V <sub>SS</sub>     |     |
| AJ11 | V <sub>SS</sub> |     | AK11 | NC                  |     | AL11 | NC                  |     | AM11 | V <sub>SS</sub>     |     |
| AJ12 | V <sub>SS</sub> |     | AK12 | V <sub>SS</sub>     |     | AL12 | V <sub>SS</sub>     |     | AM12 | V <sub>SS</sub>     |     |
| AJ13 | V <sub>SS</sub> |     | AK13 | PE7RN00             |     | AL13 | PE7RP00             |     | AM13 | V <sub>SS</sub>     |     |
| AJ14 | V <sub>SS</sub> |     | AK14 | NC                  |     | AL14 | NC                  |     | AM14 | V <sub>SS</sub>     |     |
| AJ15 | V <sub>SS</sub> |     | AK15 | V <sub>SS</sub>     |     | AL15 | V <sub>SS</sub>     |     | AM15 | V <sub>SS</sub>     |     |
| AJ16 | V <sub>SS</sub> |     | AK16 | NC                  |     | AL16 | NC                  |     | AM16 | V <sub>SS</sub>     |     |
| AJ17 | V <sub>SS</sub> |     | AK17 | NC                  |     | AL17 | NC                  |     | AM17 | V <sub>SS</sub>     |     |
| AJ18 | V <sub>SS</sub> |     | AK18 | V <sub>SS</sub>     |     | AL18 | V <sub>SS</sub>     |     | AM18 | V <sub>SS</sub>     |     |
| AJ19 | V <sub>SS</sub> |     | AK19 | PE12RN00            |     | AL19 | PE12RP00            |     | AM19 | V <sub>SS</sub>     |     |
| AJ20 | V <sub>SS</sub> |     | AK20 | NC                  |     | AL20 | NC                  |     | AM20 | V <sub>SS</sub>     |     |
| AJ21 | V <sub>SS</sub> |     | AK21 | V <sub>SS</sub>     |     | AL21 | V <sub>SS</sub>     |     | AM21 | V <sub>SS</sub>     |     |
| AJ22 | V <sub>SS</sub> |     | AK22 | NC                  |     | AL22 | NC                  |     | AM22 | V <sub>SS</sub>     |     |
| AJ23 | V <sub>SS</sub> |     | AK23 | NC                  |     | AL23 | NC                  |     | AM23 | V <sub>SS</sub>     |     |
| AJ24 | V <sub>SS</sub> |     | AK24 | V <sub>SS</sub>     |     | AL24 | V <sub>SS</sub>     |     | AM24 | V <sub>SS</sub>     |     |
| AJ25 | V <sub>SS</sub> |     | AK25 | PE13RN00            |     | AL25 | PE13RP00            |     | AM25 | V <sub>SS</sub>     |     |
| AJ26 | V <sub>SS</sub> |     | AK26 | NC                  |     | AL26 | NC                  |     | AM26 | V <sub>SS</sub>     |     |
| AJ27 | V <sub>SS</sub> |     | AK27 | V <sub>SS</sub>     |     | AL27 | V <sub>SS</sub>     |     | AM27 | V <sub>SS</sub>     |     |
| AJ28 | V <sub>SS</sub> |     | AK28 | NC                  |     | AL28 | NC                  |     | AM28 | V <sub>SS</sub>     |     |
| AJ29 | V <sub>SS</sub> |     | AK29 | NC                  |     | AL29 | NC                  |     | AM29 | V <sub>SS</sub>     |     |
| AJ30 | V <sub>SS</sub> |     | AK30 | V <sub>SS</sub>     |     | AL30 | V <sub>SS</sub>     |     | AM30 | V <sub>SS</sub>     |     |
| AJ31 | V <sub>SS</sub> |     | AK31 | GPIO_08             | 1   | AL31 | GPIO_07             | 1   | AM31 | GPIO_00             |     |
| AJ32 | V <sub>SS</sub> |     | AK32 | GPIO_15             | 1   | AL32 | V <sub>DD</sub> I/O |     | AM32 | GPIO_05             | 1   |
| AJ33 | V <sub>SS</sub> |     | AK33 | GPIO_14             | 1   | AL33 | GPIO_10             | 1   | AM33 | GPIO_11             | 1   |
| AJ34 | V <sub>SS</sub> |     | AK34 | V <sub>DD</sub> I/O |     | AL34 | GPIO_12             | 1   | AM34 | GPIO_13             | 1   |

Table 18 PES34H16 Signal Pin-Out (Part 8 of 9)



| Pin  | Function             | Alt | Pin  | Function             | Alt | Pin  | Function             | Alt | Pin  | Function             | Alt |
|------|----------------------|-----|------|----------------------|-----|------|----------------------|-----|------|----------------------|-----|
| AN1  | V <sub>SS</sub>      |     | AN18 | V <sub>SS</sub>      |     | AP1  | V <sub>SS</sub>      |     | AP18 | V <sub>SS</sub>      |     |
| AN2  | V <sub>DD</sub> /I/O |     | AN19 | PE12TN00             |     | AP2  | V <sub>SS</sub>      |     | AP19 | PE12TP00             |     |
| AN3  | V <sub>DD</sub> /I/O |     | AN20 | NC                   |     | AP3  | RSTHALT              |     | AP20 | NC                   |     |
| AN4  | SWMODE_0             |     | AN21 | V <sub>SS</sub>      |     | AP4  | SWMODE_1             |     | AP21 | V <sub>SS</sub>      |     |
| AN5  | SWMODE_2             |     | AN22 | NC                   |     | AP5  | V <sub>DD</sub> /I/O |     | AP22 | NC                   |     |
| AN6  | V <sub>SS</sub>      |     | AN23 | NC                   |     | AP6  | V <sub>SS</sub>      |     | AP23 | NC                   |     |
| AN7  | PE6TN00              |     | AN24 | V <sub>SS</sub>      |     | AP7  | PE6TP00              |     | AP24 | V <sub>SS</sub>      |     |
| AN8  | NC                   |     | AN25 | PE13TN00             |     | AP8  | NC                   |     | AP25 | PE13TP00             |     |
| AN9  | V <sub>SS</sub>      |     | AN26 | NC                   |     | AP9  | V <sub>SS</sub>      |     | AP26 | NC                   |     |
| AN10 | NC                   |     | AN27 | V <sub>SS</sub>      |     | AP10 | NC                   |     | AP27 | V <sub>SS</sub>      |     |
| AN11 | NC                   |     | AN28 | NC                   |     | AP11 | NC                   |     | AP28 | NC                   |     |
| AN12 | V <sub>SS</sub>      |     | AN29 | NC                   |     | AP12 | V <sub>SS</sub>      |     | AP29 | NC                   |     |
| AN13 | PE7TN00              |     | AN30 | V <sub>SS</sub>      |     | AP13 | PE7TP00              |     | AP30 | V <sub>SS</sub>      |     |
| AN14 | NC                   |     | AN31 | GPIO_01              |     | AP14 | NC                   |     | AP31 | V <sub>DD</sub> /I/O |     |
| AN15 | V <sub>SS</sub>      |     | AN32 | GPIO_02              |     | AP15 | V <sub>SS</sub>      |     | AP32 | GPIO_03              |     |
| AN16 | NC                   |     | AN33 | V <sub>DD</sub> /I/O |     | AP16 | NC                   |     | AP33 | V <sub>SS</sub>      |     |
| AN17 | NC                   |     | AN34 | V <sub>SS</sub>      |     | AP17 | NC                   |     | AP34 | V <sub>SS</sub>      |     |

Table 18 PES34H16 Signal Pin-Out (Part 9 of 9)

### Alternate Signal Functions

| Pin  | GPIO    | Alternate | Pin | GPIO    | Alternate   |
|------|---------|-----------|-----|---------|-------------|
| AM32 | GPIO_05 | GPEN      | B3  | GPIO_18 | P13RSTN     |
| AE25 | GPIO_06 | P1RSTN    | A3  | GPIO_19 | P14RSTN     |
| AL31 | GPIO_07 | P2RSTN    | H8  | GPIO_20 | P15RSTN     |
| AK31 | GPIO_08 | P3RSTN    | C3  | GPIO_21 | IOEXPINTN0  |
| AF26 | GPIO_09 | P4RSTN    | K10 | GPIO_22 | IOEXPINTN1  |
| AL33 | GPIO_10 | P5RSTN    | D4  | GPIO_23 | IOEXPINTN2  |
| AM33 | GPIO_11 | P6RSTN    | E4  | GPIO_24 | IOEXPINTN3  |
| AL34 | GPIO_12 | P7RSTN    | J9  | GPIO_25 | IOEXPINTN4  |
| AM34 | GPIO_13 | P8RSTN    | D2  | GPIO_26 | IOEXPINTN5  |
| AK33 | GPIO_14 | P9RSTN    | C2  | GPIO_27 | IOEXPINTN6  |
| AK32 | GPIO_15 | P10RSTN   | D1  | GPIO_28 | IOEXPINTN7  |
| C4   | GPIO_16 | P11RSTN   | E3  | GPIO_31 | IOEXPINTN10 |
| B4   | GPIO_17 | P12RSTN   | —   | —       | —           |

Table 19 PES34H16 Alternate Signal Functions

## Power Pins

| V <sub>DDCore</sub> | V <sub>DDCore</sub> | V <sub>DDI/O</sub> | V <sub>DDPE</sub> | V <sub>DDPE</sub> | V <sub>DDAPE</sub> | V <sub>TTPE</sub> |
|---------------------|---------------------|--------------------|-------------------|-------------------|--------------------|-------------------|
| N13                 | V19                 | A4                 | J14               | V11               | H15                | H13               |
| N14                 | V21                 | A30                | J21               | V12               | H20                | H22               |
| N15                 | V22                 | B2                 | L13               | V23               | K15                | J17               |
| N17                 | W13                 | B33                | L14               | V24               | K20                | J18               |
| N19                 | W14                 | D3                 | L15               | Y11               | R8                 | K13               |
| N20                 | W16                 | D31                | L17               | Y12               | R10                | K17               |
| N21                 | W18                 | D34                | L18               | Y23               | R25                | K18               |
| N22                 | W20                 | E1                 | L20               | Y24               | R27                | K22               |
| P13                 | Y13                 | H9                 | L21               | AA9               | Y8                 | N8                |
| P15                 | Y15                 | H27                | L22               | AA11              | Y10                | N10               |
| P17                 | Y17                 | J26                | M13               | AA24              | Y25                | N25               |
| P19                 | Y19                 | K9                 | M15               | AA26              | Y27                | N27               |
| P21                 | Y21                 | AE9                | M17               | AB11              | AE15               | U9                |
| P22                 | Y22                 | AE26               | M18               | AB12              | AE20               | U10               |
| R13                 | AA13                | AF9                | M20               | AB23              | AG15               | U25               |
| R14                 | AA14                | AF10               | M22               | AB24              | AG20               | U26               |
| R16                 | AA16                | AG8                | N11               | AC13              |                    | V9                |
| R18                 | AA18                | AG26               | N12               | AC15              |                    | V10               |
| R20                 | AA20                | AK34               | N23               | AC17              |                    | V25               |
| R22                 | AA22                | AL1                | N24               | AC18              |                    | V26               |
| T15                 | AB13                | AL4                | P9                | AC20              |                    | AB8               |
| T17                 | AB14                | AL5                | P11               | AC22              |                    | AB10              |
| T19                 | AB15                | AL32               | P24               | AD13              |                    | AB25              |
| T21                 | AB16                | AM2                | P26               | AD14              |                    | AB27              |
| T22                 | AB18                | AM3                | R11               | AD15              |                    | AE13              |
| U13                 | AB20                | AM4                | R12               | AD17              |                    | AE17              |
| U14                 | AB21                | AN2                | R23               | AD18              |                    | AE18              |
| U16                 | AB22                | AN3                | R24               | AD20              |                    | AE22              |
| U18                 |                     | AN33               | U11               | AD21              |                    | AF17              |
| U20                 |                     | AP5                | U12               | AD22              |                    | AF18              |
| V15                 |                     | AP31               | U23               | AF14              |                    | AG13              |
| V17                 |                     |                    | U24               | AF21              |                    | AG22              |

Table 20 PES34H16 Power Pins

## Ground Pins

| V <sub>SS</sub> | V <sub>SS</sub> | V <sub>SS</sub> | V <sub>SS</sub> | V <sub>SS</sub> | V <sub>SS</sub> | V <sub>SS</sub> | V <sub>SS</sub> |
|-----------------|-----------------|-----------------|-----------------|-----------------|-----------------|-----------------|-----------------|
| A1              | C16             | E33             | G8              | H29             | K16             | M5              | P12             |
| A2              | C17             | E34             | G9              | H30             | K19             | M6              | P14             |
| A5              | C18             | F1              | G10             | H31             | K21             | M7              | P16             |
| A8              | C19             | F2              | G11             | H32             | K23             | M8              | P18             |
| A11             | C20             | F3              | G12             | H33             | K24             | M9              | P20             |
| A14             | C21             | F4              | G13             | H34             | K27             | M10             | P23             |
| A17             | C22             | F5              | G14             | J1              | K28             | M11             | P25             |
| A20             | C23             | F6              | G15             | J2              | K29             | M12             | P27             |
| A23             | C24             | F7              | G16             | J3              | K32             | M14             | P28             |
| A26             | C25             | F8              | G19             | J4              | L3              | M16             | P29             |
| A29             | C26             | F9              | G20             | J5              | L6              | M19             | P30             |
| A33             | C27             | F10             | G21             | J6              | L7              | M21             | P31             |
| A34             | C28             | F11             | G22             | J7              | L8              | M23             | P32             |
| B1              | C29             | F12             | G23             | J8              | L9              | M24             | P33             |
| B5              | D5              | F13             | G24             | J10             | L10             | M25             | P34             |
| B8              | D8              | F14             | G25             | J11             | L11             | M26             | R1              |
| B11             | D11             | F15             | G26             | J12             | L12             | M27             | R2              |
| B14             | D14             | F16             | G28             | J13             | L16             | M28             | R3              |
| B17             | D17             | F17             | G29             | J15             | L19             | M29             | R4              |
| B20             | D20             | F18             | G32             | J16             | L23             | M32             | R5              |
| B23             | D23             | F19             | H3              | J19             | L24             | N3              | R6              |
| B26             | D26             | F20             | H6              | J20             | L25             | N6              | R7              |
| B29             | D29             | F21             | H7              | J22             | L26             | N7              | R9              |
| B34             | E5              | F22             | H10             | J23             | L27             | N9              | R15             |
| C5              | E8              | F23             | H11             | J24             | L28             | N16             | R17             |
| C6              | E11             | F24             | H12             | J28             | L29             | N18             | R19             |
| C7              | E14             | F25             | H14             | J29             | L30             | N26             | R21             |
| C8              | E17             | F26             | H16             | J32             | L31             | N28             | R26             |
| C9              | E20             | F27             | H17             | K3              | L32             | N29             | R28             |
| C10             | E23             | F28             | H18             | K6              | L33             | N32             | R29             |
| C11             | E26             | F29             | H19             | K7              | L34             | P3              | R32             |
| C12             | E29             | F32             | H21             | K8              | M1              | P6              | T3              |
| C13             | E30             | G3              | H23             | K11             | M2              | P7              | T6              |
| C14             | E31             | G6              | H24             | K12             | M3              | P8              | T7              |
| C15             | E32             | G7              | H25             | K14             | M4              | P10             | T8              |

Table 21 PES34H16 Ground Pins (Part 1 of 3)

| V <sub>SS</sub> | V <sub>SS</sub> | V <sub>SS</sub> | V <sub>SS</sub> | V <sub>SS</sub> | V <sub>SS</sub> | V <sub>SS</sub> | V <sub>SS</sub> |
|-----------------|-----------------|-----------------|-----------------|-----------------|-----------------|-----------------|-----------------|
| T9              | V6              | Y18             | AB28            | AD11            | AF16            | AH3             | AJ19            |
| T10             | V8              | Y20             | AB29            | AD12            | AF19            | AH6             | AJ20            |
| T11             | V13             | Y26             | AB32            | AD16            | AF20            | AH7             | AJ21            |
| T12             | V14             | Y28             | AC3             | AD19            | AF22            | AH9             | AJ22            |
| T13             | V16             | Y29             | AC6             | AD23            | AF23            | AH10            | AJ23            |
| T14             | V18             | Y30             | AC7             | AD24            | AF24            | AH11            | AJ24            |
| T16             | V20             | Y31             | AC8             | AD25            | AF25            | AH12            | AJ25            |
| T18             | V27             | Y32             | AC9             | AD26            | AF27            | AH13            | AJ26            |
| T20             | V29             | Y33             | AC10            | AD27            | AF28            | AH14            | AJ27            |
| T23             | V32             | Y34             | AC11            | AD28            | AF29            | AH15            | AJ28            |
| T24             | W3              | AA1             | AC12            | AD29            | AF30            | AH16            | AJ29            |
| T25             | W6              | AA2             | AC14            | AD32            | AF31            | AH19            | AJ30            |
| T26             | W7              | AA3             | AC16            | AE3             | AF32            | AH20            | AJ31            |
| T27             | W8              | AA4             | AC19            | AE6             | AF33            | AH21            | AJ32            |
| T28             | W9              | AA5             | AC21            | AE7             | AF34            | AH22            | AJ33            |
| T29             | W10             | AA6             | AC23            | AE8             | AG1             | AH23            | AJ34            |
| T32             | W11             | AA7             | AC24            | AE10            | AG2             | AH24            | AK1             |
| U3              | W12             | AA8             | AC25            | AE11            | AG3             | AH25            | AK2             |
| U6              | W15             | AA10            | AC26            | AE12            | AG4             | AH26            | AK3             |
| U8              | W17             | AA12            | AC27            | AE14            | AG5             | AH27            | AK4             |
| U15             | W19             | AA15            | AC28            | AE16            | AG6             | AH28            | AK5             |
| U17             | W21             | AA17            | AC29            | AE19            | AG9             | AH29            | AK6             |
| U19             | W22             | AA19            | AC30            | AE21            | AG10            | AH32            | AK9             |
| U21             | W23             | AA21            | AC31            | AE23            | AG11            | AJ3             | AK12            |
| U22             | W24             | AA23            | AC32            | AE24            | AG12            | AJ6             | AK15            |
| U27             | W25             | AA25            | AC33            | AE27            | AG14            | AJ7             | AK18            |
| U29             | W26             | AA27            | AC34            | AE28            | AG16            | AJ8             | AK21            |
| U30             | W27             | AA28            | AD1             | AE29            | AG17            | AJ9             | AK24            |
| U31             | W28             | AA29            | AD2             | AE32            | AG18            | AJ10            | AK27            |
| U32             | W29             | AA32            | AD3             | AF3             | AG19            | AJ11            | AK30            |
| U33             | W32             | AB3             | AD4             | AF6             | AG21            | AJ12            | AL6             |
| U34             | Y3              | AB6             | AD5             | AF7             | AG23            | AJ13            | AL9             |
| V1              | Y6              | AB7             | AD6             | AF8             | AG24            | AJ14            | AL12            |
| V2              | Y7              | AB9             | AD7             | AF11            | AG25            | AJ15            | AL15            |
| V3              | Y9              | AB17            | AD8             | AF12            | AG28            | AJ16            | AL18            |
| V4              | Y14             | AB19            | AD9             | AF13            | AG29            | AJ17            | AL21            |
| V5              | Y16             | AB26            | AD10            | AF15            | AG32            | AJ18            | AL24            |

Table 21 PES34H16 Ground Pins (Part 2 of 3)

| V <sub>SS</sub> | V <sub>SS</sub> | V <sub>SS</sub> | V <sub>SS</sub> | V <sub>SS</sub> | V <sub>SS</sub> | V <sub>SS</sub> | V <sub>SS</sub> |
|-----------------|-----------------|-----------------|-----------------|-----------------|-----------------|-----------------|-----------------|
| AL27            | AM11            | AM18            | AM25            | AN6             | AN27            | AP12            | AP33            |
| AL30            | AM12            | AM19            | AM26            | AN9             | AN30            | AP15            | AP34            |
| AM6             | AM13            | AM20            | AM27            | AN12            | AN34            | AP18            |                 |
| AM7             | AM14            | AM21            | AM28            | AN15            | AP1             | AP21            |                 |
| AM8             | AM15            | AM22            | AM29            | AN18            | AP2             | AP24            |                 |
| AM9             | AM16            | AM23            | AM30            | AN21            | AP6             | AP27            |                 |
| AM10            | AM17            | AM24            | AN1             | AN24            | AP9             | AP30            |                 |

Table 21 PES34H16 Ground Pins (Part 3 of 3)

### No Connection Pins

| NC  | NC  | NC | NC   | NC   | NC   | NC   | NC   |
|-----|-----|----|------|------|------|------|------|
| A6  | D12 | K4 | U2   | AD30 | AK14 | AL20 | AN26 |
| A7  | D13 | K5 | U4   | AD31 | AK16 | AL22 | AN28 |
| A9  | D15 | L1 | U5   | AD33 | AK17 | AL23 | AN29 |
| A12 | E6  | L2 | V30  | AD34 | AK20 | AL26 | AP8  |
| A13 | E7  | L4 | V31  | AE30 | AK22 | AL28 | AP10 |
| A15 | E9  | L5 | V33  | AE31 | AK23 | AL29 | AP11 |
| B6  | E12 | P1 | V34  | AE33 | AK26 | AN8  | AP14 |
| B7  | E13 | P2 | W30  | AE34 | AK28 | AN10 | AP16 |
| B9  | E15 | P4 | W31  | AG30 | AK29 | AN11 | AP17 |
| B12 | H1  | P5 | W33  | AG31 | AL8  | AN14 | AP20 |
| B13 | H2  | T1 | W34  | AG33 | AL10 | AN16 | AP22 |
| B15 | H4  | T2 | AA30 | AG34 | AL11 | AN17 | AP23 |
| D6  | H5  | T4 | AA31 | AK8  | AL14 | AN20 | AP26 |
| D7  | K1  | T5 | AA33 | AK10 | AL16 | AN22 | AP28 |
| D9  | K2  | U1 | AA34 | AK11 | AL17 | AN23 | AP29 |

Table 22 PES34H16 No Connection Pins

**Signals Listed Alphabetically**

| Signal Name | I/O Type | Location | Signal Category     |
|-------------|----------|----------|---------------------|
| CCLKDS      | I        | K25      | System              |
| CCLKUS      | I        | AG7      |                     |
| GPIO_00     | I/O      | AM31     | General Purpose I/O |
| GPIO_01     | I/O      | AN31     |                     |
| GPIO_02     | I/O      | AN32     |                     |
| GPIO_03     | I/O      | AP32     |                     |
| GPIO_04     | I/O      | AG27     |                     |
| GPIO_05     | I/O      | AM32     |                     |
| GPIO_06     | I/O      | AE25     |                     |
| GPIO_07     | I/O      | AL31     |                     |
| GPIO_08     | I/O      | AK31     |                     |
| GPIO_09     | I/O      | AF26     |                     |
| GPIO_10     | I/O      | AL33     |                     |
| GPIO_11     | I/O      | AM33     |                     |
| GPIO_12     | I/O      | AL34     |                     |
| GPIO_13     | I/O      | AM34     |                     |
| GPIO_14     | I/O      | AK33     |                     |
| GPIO_15     | I/O      | AK32     |                     |
| GPIO_16     | I/O      | C4       |                     |
| GPIO_17     | I/O      | B4       |                     |
| GPIO_18     | I/O      | B3       |                     |
| GPIO_19     | I/O      | A3       |                     |
| GPIO_20     | I/O      | H8       |                     |
| GPIO_21     | I/O      | C3       |                     |
| GPIO_22     | I/O      | K10      |                     |
| GPIO_23     | I/O      | D4       |                     |
| GPIO_24     | I/O      | E4       |                     |
| GPIO_25     | I/O      | J9       |                     |
| GPIO_26     | I/O      | D2       |                     |
| GPIO_27     | I/O      | C2       |                     |
| GPIO_28     | I/O      | D1       |                     |
| GPIO_29     | I/O      | C1       |                     |
| GPIO_30     | I/O      | E2       |                     |
| GPIO_31     | I/O      | E3       |                     |

Table 23 89PES34H16 Alphabetical Signal List (Part 1 of 6)

| Signal Name | I/O Type                                   | Location | Signal Category |
|-------------|--|----------|-----------------|
| JTAG_TCK    | I  | K26      | Test            |
| JTAG_TDI    | I  | C31      |                 |
| JTAG_TDO    | O  | J25      |                 |
| JTAG_TMS    | I  | D30      |                 |
| JTAG_TRST_N | I  | C32      |                 |
| MSMBADDR_1  | I  | A31      | SMBus Interface |
| MSMBADDR_2  | I  | B31      |                 |
| MSMBADDR_3  | I  | B30      |                 |
| MSMBADDR_4  | I  | C30      |                 |
| MSMBCLK     | I/O  | G27      |                 |
| MSMBDAT     | I/O  | H26      |                 |
| MSMBSMODE   | I  | A32      | System          |
| NO CONNECT  | See Table 22 for a list of No Connect Pins |          |                 |
| P01MERGEN   | I  | AL2      | System          |
| P23MERGEN   | I  | AM1      |                 |
| P45MERGEN   | I  | AL3      |                 |
| PE0RN00     | I  | T30      | PCI Express     |
| PE0RN01     | I  | R30      |                 |
| PE0RN02     | I  | N30      |                 |
| PE0RN03     | I  | M30      |                 |
| PE0RP00     | I  | T31      |                 |
| PE0RP01     | I  | R31      |                 |
| PE0RP02     | I  | N31      |                 |
| PE0RP03     | I  | M31      |                 |
| PE0TN00     | O  | T33      |                 |
| PE0TN01     | O  | R33      |                 |
| PE0TN02     | O  | N33      |                 |
| PE0TN03     | O  | M33      |                 |
| PE0TP00     | O  | T34      |                 |
| PE0TP01     | O  | R34      |                 |
| PE0TP02     | O  | N34      |                 |
| PE0TP03     | O  | M34      |                 |
| PE1RN00     | I  | K30      |                 |
| PE1RN01     | I  | J30      |                 |
| PE1RN02     | I  | G30      |                 |
| PE1RN03     | I  | F30      |                 |

Table 23 89PES34H16 Alphabetical Signal List (Part 2 of 6)



| Signal Name | I/O Type | Location | Signal Category     |
|-------------|----------|----------|---------------------|
| PE1RP00     | I        | K31      | PCI Express (cont.) |
| PE1RP01     | I        | J31      |                     |
| PE1RP02     | I        | G31      |                     |
| PE1RP03     | I        | F31      |                     |
| PE1TN00     | O        | K33      |                     |
| PE1TN01     | O        | J33      |                     |
| PE1TN02     | O        | G33      |                     |
| PE1TN03     | O        | F33      |                     |
| PE1TP00     | O        | K34      |                     |
| PE1TP01     | O        | J34      |                     |
| PE1TP02     | O        | G34      |                     |
| PE1TP03     | O        | F34      |                     |
| PE2RN00     | I        | E28      |                     |
| PE2RN01     | I        | E27      |                     |
| PE2RN02     | I        | E25      |                     |
| PE2RN03     | I        | E24      |                     |
| PE2RP00     | I        | D28      |                     |
| PE2RP01     | I        | D27      |                     |
| PE2RP02     | I        | D25      |                     |
| PE2RP03     | I        | D24      |                     |
| PE2TN00     | O        | B28      |                     |
| PE2TN01     | O        | B27      |                     |
| PE2TN02     | O        | B25      |                     |
| PE2TN03     | O        | B24      |                     |
| PE2TP00     | O        | A28      |                     |
| PE2TP01     | O        | A27      |                     |
| PE2TP02     | O        | A25      |                     |
| PE2TP03     | O        | A24      |                     |
| PE3RN00     | I        | E22      |                     |
| PE3RN01     | I        | E21      |                     |
| PE3RN02     | I        | E19      |                     |
| PE3RN03     | I        | E18      |                     |
| PE3RP00     | I        | D22      |                     |
| PE3RP01     | I        | D21      |                     |
| PE3RP02     | I        | D19      |                     |
| PE3RP03     | I        | D18      |                     |

Table 23 89PES34H16 Alphabetical Signal List (Part 3 of 6)

| Signal Name | I/O Type | Location | Signal Category     |
|-------------|----------|----------|---------------------|
| PE3TN00     | O        | B22      | PCI Express (cont.) |
| PE3TN01     | O        | B21      |                     |
| PE3TN02     | O        | B19      |                     |
| PE3TN03     | O        | B18      |                     |
| PE3TP00     | O        | A22      |                     |
| PE3TP01     | O        | A21      |                     |
| PE3TP02     | O        | A19      |                     |
| PE3TP03     | O        | A18      |                     |
| PE4RN00     | I        | W5       |                     |
| PE4RN01     | I        | Y5       |                     |
| PE4RN02     | I        | AB5      |                     |
| PE4RN03     | I        | AC5      |                     |
| PE4RP00     | I        | W4       |                     |
| PE4RP01     | I        | Y4       |                     |
| PE4RP02     | I        | AB4      |                     |
| PE4RP03     | I        | AC4      |                     |
| PE4TN00     | O        | W2       |                     |
| PE4TN01     | O        | Y2       |                     |
| PE4TN02     | O        | AB2      |                     |
| PE4TN03     | O        | AC2      |                     |
| PE4TP00     | O        | W1       |                     |
| PE4TP01     | O        | Y1       |                     |
| PE4TP02     | O        | AB1      |                     |
| PE4TP03     | O        | AC1      |                     |
| PE5RN00     | I        | AE5      |                     |
| PE5RN01     | I        | AF5      |                     |
| PE5RN02     | I        | AH5      |                     |
| PE5RN03     | I        | AJ5      |                     |
| PE5RP00     | I        | AE4      |                     |
| PE5RP01     | I        | AF4      |                     |
| PE5RP02     | I        | AH4      |                     |
| PE5RP03     | I        | AJ4      |                     |
| PE5TN00     | O        | AE2      |                     |
| PE5TN01     | O        | AF2      |                     |
| PE5TN02     | O        | AH2      |                     |
| PE5TN03     | O        | AJ2      |                     |

Table 23 89PES34H16 Alphabetical Signal List (Part 4 of 6)

| Signal Name | I/O Type | Location | Signal Category     |
|-------------|----------|----------|---------------------|
| PE5TP00     | O        | AE1      | PCI Express (cont.) |
| PE5TP01     | O        | AF1      |                     |
| PE5TP02     | O        | AH1      |                     |
| PE5TP03     | O        | AJ1      |                     |
| PE6RN00     | I        | AK7      |                     |
| PE6RP00     | I        | AL7      |                     |
| PE6TN00     | O        | AN7      |                     |
| PE6TP00     | O        | AP7      |                     |
| PE7RN00     | I        | AK13     |                     |
| PE7RP00     | I        | AL13     |                     |
| PE7TN00     | O        | AN13     |                     |
| PE7TP00     | O        | AP13     |                     |
| PE8RN00     | I        | E16      |                     |
| PE8RP00     | I        | D16      |                     |
| PE8TN00     | O        | B16      |                     |
| PE8TP00     | O        | A16      |                     |
| PE9RN00     | I        | E10      |                     |
| PE9RP00     | I        | D10      |                     |
| PE9TN00     | O        | B10      |                     |
| PE9TP00     | O        | A10      |                     |
| PE10RN00    | I        | G5       |                     |
| PE10RP00    | I        | G4       |                     |
| PE10TN00    | O        | G2       |                     |
| PE10TP00    | O        | G1       |                     |
| PE11RN00    | I        | N5       |                     |
| PE11RP00    | I        | N4       |                     |
| PE11TN00    | O        | N2       |                     |
| PE11TP00    | O        | N1       |                     |
| PE12RN00    | I        | AK19     |                     |
| PE12RP00    | I        | AL19     |                     |
| PE12TN00    | O        | AN19     |                     |
| PE12TP00    | O        | AP19     |                     |
| PE13RN00    | I        | AK25     |                     |
| PE13RP00    | I        | AL25     |                     |
| PE13TN00    | O        | AN25     |                     |
| PE13TP00    | O        | AP25     |                     |

Table 23 89PES34H16 Alphabetical Signal List (Part 5 of 6)

| Signal Name  | I/O Type                                   | Location | Signal Category     |             |
|--|--|----------|---------------------|-------------|
| PE14RN00   | I  | AH30     | PCI Express (cont.) |             |
| PE14RP00   | I  | AH31     |                     |             |
| PE14TN00   | O  | AH33     |                     |             |
| PE14TP00   | O  | AH34     |                     |             |
| PE15RN00   | I  | AB30     |                     |             |
| PE15RP00   | I  | AB31     |                     |             |
| PE15TN00   | O  | AB33     |                     |             |
| PE15TP00   | O  | AB34     |                     |             |
| PEREFCLKN0   | I  | V28      |                     |             |
| PEREFCLKN1   | I  | G18      |                     |             |
| PEREFCLKN2   | I  | U7       |                     |             |
| PEREFCLKN3   | I  | AH17     |                     |             |
| PEREFCLKP0   | I  | U28      |                     |             |
| PEREFCLKP1   | I  | G17      |                     |             |
| PEREFCLKP2   | I  | V7       |                     |             |
| PEREFCLKP3   | I  | AH18     |                     |             |
| PERSTN   | I  | B32      |                     | System      |
| REFCLKM  | I  | AH8      |                     | PCI Express |
| RSTHALT  | I  | AP3      | System              |             |
| SSMBADDR_1   | I  | C34      | SMBus Interface     |             |
| SSMBADDR_2   | I  | C33      |                     |             |
| SSMBADDR_3   | I  | D33      |                     |             |
| SSMBADDR_5   | I  | D32      |                     |             |
| SSMBCLK  | I/O  | H28      |                     |             |
| SSMBDAT  | I/O  | J27      |                     |             |
| SWMODE_0   | I  | AN4      | System              |             |
| SWMODE_1   | I  | AP4      |                     |             |
| SWMODE_2   | I  | AN5      |                     |             |
| SWMODE_3   | I  | AM5      |                     |             |
| V <sub>DD</sub> CORE,<br>V <sub>DD</sub> APE, V <sub>DD</sub> I/O,<br>V <sub>DD</sub> PE, V <sub>TT</sub> PE | See Table 20 for a listing of power pins.  |          |                     |             |
| V <sub>SS</sub>  | See Table 21 for a listing of ground pins. |          |                     |             |

Table 23 89PES34H16 Alphabetical Signal List (Part 6 of 6)

# PES34H16 Pinout — Top View

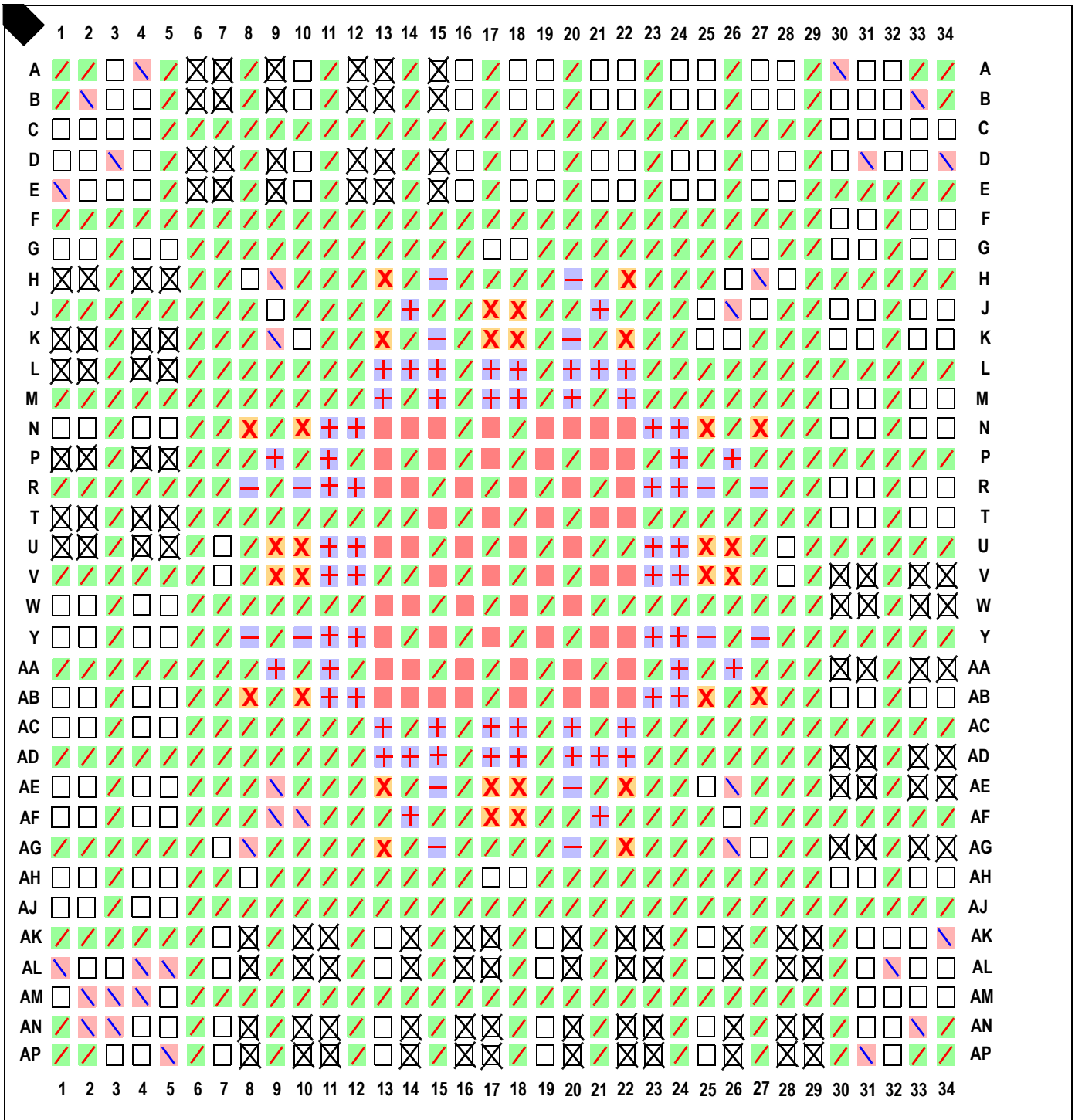

|  |   |  |  |   |
|--|---|--|--|---|
|  V <sub>DD</sub> Core (Power) |  V <sub>DD</sub> APE (Power) |  V <sub>TT</sub> PE (Power) |  V <sub>ss</sub> (Ground) |  Signals |
|  V <sub>DD</sub> I/O (Power)  |  V <sub>DD</sub> PE (Power)  |  No connect               |  |   |

# PES34H16 Package Drawing — 1156-Pin BL1156/BR1156

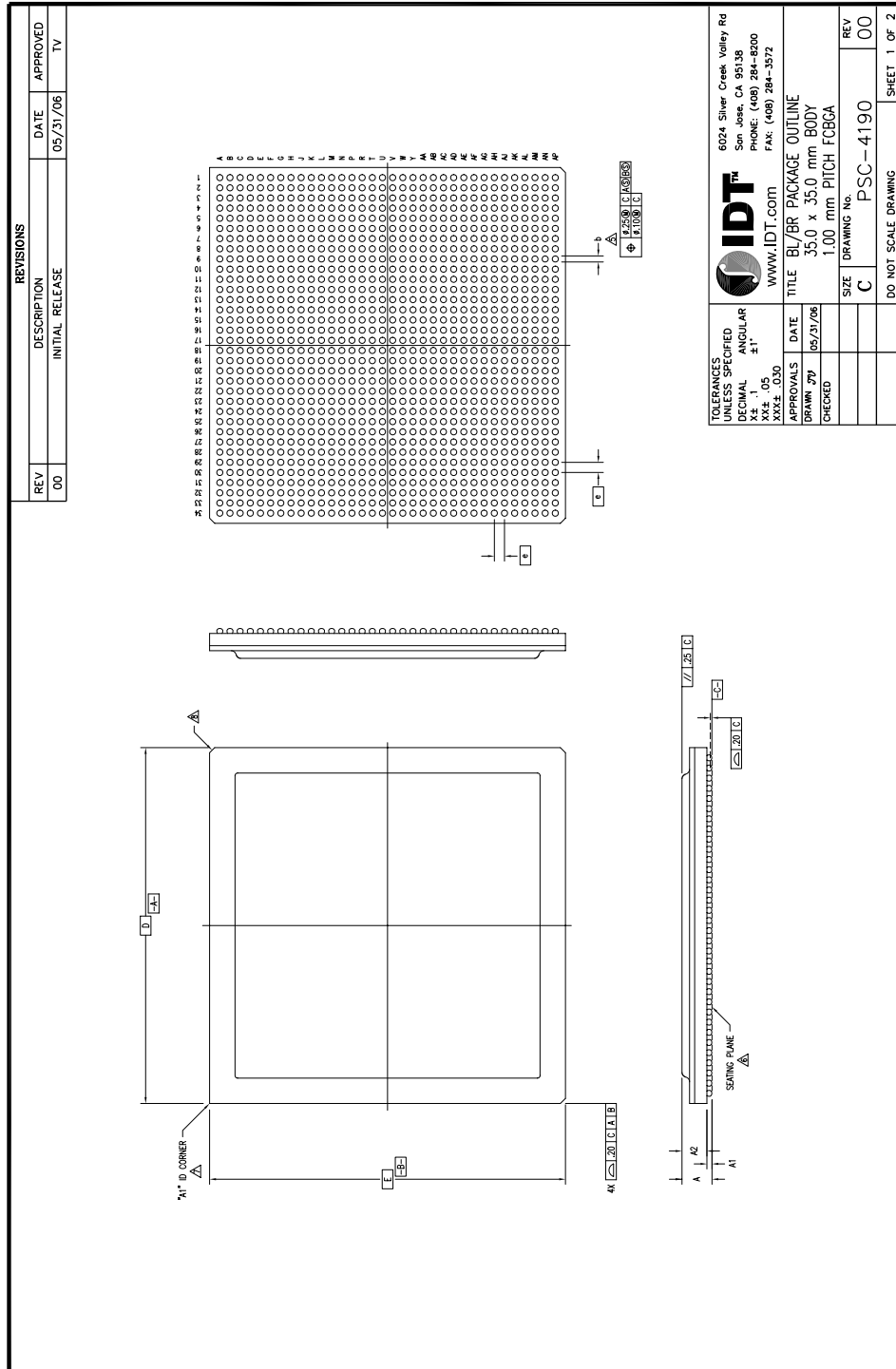

PES34H16 Package Drawing — Page Two

| REVISIONS |                 | DATE     | APPROVED |
|-----------|-----------------|----------|----------|
| REV       | DESCRIPTION     | DATE     | APPROVED |
| 00        | INITIAL RELEASE | 05/31/06 | TV       |

**NOTES:**

- 1 ALL DIMENSIONING AND TOLERANCING CONFORM TO ANSI Y14.5M-1992
- 2 "S" REPRESENTS THE BASIC SOLDER BALL GRID PITCH
- 3 "M" REPRESENTS THE MAXIMUM SOLDER BALL MATRIX SIZE
- 4 "N" REPRESENTS THE BALLCOUNT NUMBER

△ DIMENSION "L" IS MEASURED AT THE MAXIMUM SOLDER BALL DIAMETER, PARALLEL TO PRIMARY DATUM [C-C]

△ SEATING PLANE AND PRIMARY DATUM [C-C] ARE DEFINED BY THE SPHERICAL CROUNES OF THE SOLDER BALLS

△ "A1" ID CORNER MUST BE IDENTIFIED BY CHAMFER, INK MARK, METALLIZED MARKING, INDENTATION OR OTHER FEATURE ON PACKAGE BODY

△ EXACT SHAPE OF EACH CORNER IS OPTIONAL

9 ALL DIMENSIONS ARE IN MILLIMETERS

1156 BALLS

| SYMBOL             | JEDEC VARIATION |     |      | N |
|--------------------|-----------------|-----|------|---|
|                    | MIN             | NOM | MAX  |   |
| A                  | —               | —   | 3.42 | — |
| A1                 | .30             | —   | —    | — |
| A2                 | 2.16            | —   | 2.82 | — |
| D                  | 35.00 BSC       |     |      | — |
| E                  | 35.00 BSC       |     |      | — |
| M                  | 34              |     |      | 3 |
| N                  | 1156            |     |      | 4 |
| e                  | 1.00 BSC        |     |      | — |
| b                  | .50             | .60 | .70  | 5 |
| CENTER BALL MATRIX | N/A             |     |      | — |

|                             |         |                     |          |                       |             |
|-----------------------------|---------|---------------------|----------|-----------------------|-------------|
| TOLERANCES UNLESS SPECIFIED | DECIMAL | ANGULAR             | DATE     | TITLE                 | DRAWING No. |
| XX± .05                     | ±1°     | ±1°                 | 05/31/06 | BL/BR PACKAGE OUTLINE | PSC-4190    |
| APPROVALS                   | DATE    | SIZE                | REV      | C                     | 00          |
| CHECKED                     |         | 35.0 x 35.0 mm BODY |          |                       |             |
|                             |         | 1.00 mm PITCH FCBCA |          |                       |             |
| DO NOT SCALE DRAWING        |         |                     |          |                       |             |
| SHEET 2 OF 2                |         |                     |          |                       |             |

6024 Silver Creek Valley Rd  
 San Jose, CA 95138  
 PHONE: (408) 284-8200  
 FAX: (408) 284-3572  
 WWW.IDT.COM

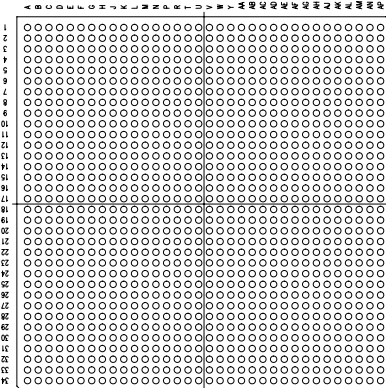

## Revision History

**January 17, 2008:** Initial publication of Preliminary data sheet.

**April 16, 2008:** In Table 16, Thermal Specifications, revised values for  $\theta_{JA}$ ,  $\theta_{JB}$ , and  $\theta_{JC}$ .

**October 7, 2008:** In Table 5, revised description of PxxMERGEN pins.

**November 17, 2008:** In Table 22, pin AK10 was written twice. One AK10 was changed to AL10.

**October 21, 2009:** Added Industrial temperature to ordering codes on page 45.



## Ordering Information

| Product Family | Operating Voltage | Device Family | Product Detail | Device Revision | Package | Temp Range |  |
|----------------|-------------------|---------------|----------------|-----------------|---------|------------|--|
|                |                   |               |                |                 |         | Blank      | Commercial Temperature<br>(0°C to +70°C Ambient)     |
|                |                   |               |                |                 |         | I          | Industrial Temperature<br>(-40° C to +85° C Ambient) |
|                |                   |               |                |                 | BL      |            | 1156-ball FCBGA                                      |
|                |                   |               |                |                 | BR      |            | 1156-ball FCBGA, RoHS                                |
|                |                   |               |                | ZA              |         |            | ZA revision  |
|                |                   |               | 34H16          |                 |         |            | 34-lane, 16-port                                     |
|                |                   |               |                |                 |         | PES        | PCI Express Switch                                   |
|                | H                 |               |                |                 |         |            | 1.0V +/- 0.1V Core Voltage                           |
|                |                   |               |                |                 |         | 89         | Serial Switching Product                             |

Legend

A = Alpha Character  
N = Numeric Character

### Valid Combinations

|                  |  |
|------------------|--|
| 89HPES34H16ZABL  | 1156-ball FCBGA package, Commercial Temperature      |
| 89HPES34H16ZABR  | 1156-ball RoHS FCBGA package, Commercial Temperature |
| 89HPES34H16ZABLI | 1156-ball FCBGA package, Industrial Temperature      |
| 89HPES34H16ZABRI | 1156-ball RoHS FCBGA package, Industrial Temperature |



**CORPORATE HEADQUARTERS**  
6024 Silver Creek Valley Road  
San Jose, CA 95138

**for SALES:**  
800-345-7015 or 408-284-8200  
fax: 408-284-2775  
[www.idt.com](http://www.idt.com)

**for Tech Support:**  
email: [ssdhelp@idt.com](mailto:ssdhelp@idt.com)  
phone: 408-284-8208