

FSSD07

1-Bit / 4-Bit SD/SDIO and MMC Dual-Host Multiplexer

Features

- On Resistance: 5Ω Typical, $V_{DDC}=2.7V$
- f_{toggle} : >75MHz
- Low On Capacitance: 6pF Typical
- Low Power Consumption: 2μA Maximum
- Supports Secure Digital (SD), Secure Digital I/O (SDIO), and Multimedia Card (MMC) Specifications
- Supports 1-Bit / 4-Bit Host Controllers ($V_{DDH1/H2}=1.65V$ to 3.6V) Communicating with High-Voltage (2.7-3.6V) and Dual-Voltage Cards (1.65-1.95V, 2.7-3.6V)
 - $V_{DDC}=1.65$ to 3.6V, $V_{DDH1/H2}=1.65$ to 3.6V
- 24-Lead MLP and UMLP Packages

Applications

- Cell Phone, PDA, Digital Camera, Portable GPS, and Notebook Computer
- LCD Monitor, TV, and Set-Top Box

IMPORTANT NOTE:

For additional performance information, please contact analogswitch@fairchildsemi.com.

Description

The FSSD07 is a 2:1 multiplexer that allows dual Secure Digital (SD), Secure Digital I/O (SDIO), and Multimedia Card (MMC) host controllers to share a common peripheral. The host controllers can be equal to, greater than, or less than peripheral card supply with minimal power consumption. This configuration enables dual host CMD, CLK, and D[3:0] signals to be multiplexed to a common peripheral.

The architecture includes the necessary bi-directional data and command transfer capability for single high-voltage cards or dual-voltage supply cards. The clock path is a uni-directional buffer.

Typical applications involve switching in portables and consumer applications: cell phones, digital cameras, home theater monitors, set-top boxes, and notebooks.

Analog Symbol

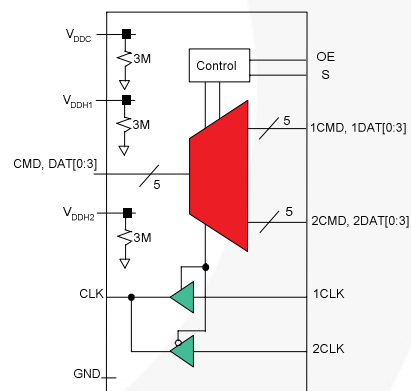

Figure 1. Analog Symbol Diagram

Ordering Information







Part Number	Top Mark	Operating Temperature Range	Eco Status	Package Description	Packing Method
FSSD07BQX	FSSD07	-40°C to +85°C	Green	24-Lead Molded Leadless Package (MLP), JEDEC MO-220, 3.5 x 4.5mm	Tape & Reel
FSSD07UMX	JK	-40°C to +85°C	Green	24-Lead Ultra-thin Molded Leadless Package (UMLP), 0.4mm pitch	Tape & Reel

For Fairchild's definition of Eco Status, please visit: http://www.fairchildsemi.com/company/green/rohs_green.html.



TRADEMARKS

The following includes registered and unregistered trademarks and service marks, owned by Fairchild Semiconductor and/or its global subsidiaries, and is not intended to be an exhaustive list of all such trademarks.

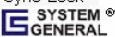
- | | | | |
|---|---|---|---|
| Auto-SPM™ | F-PFST™ | PowerTrench® | The Power Franchise® |
| Build it Now!™ | FRFET® | PowerXS™ |  the power franchise |
| CorePLUSTM | Global Power Resource™ SM | Programmable Active Droop™ | TinyBoost™ |
| CorePOWER™ | Green FPST™ | QFET® | TinyBuck™ |
| CROSSVOLT™ | Green FPST™ e-Series™ | QS™ | TinyLogic® |
| CTL™ | Gmax™ | Quiet Series™ | TINYOPTO™ |
| Current Transfer Logic™ | GTO™ | RapidConfigure™ | TinyPower™ |
| EcoSPARK® | IntelliMAX™ |  TM | TinyPWM™ |
| EfficientMax™ | ISOPLANAR™ | Saving our world, 1mW/W/kW at a time™ | TinyWire™ |
| EZSWITCH™ | MegaBuck™ | SmartMax™ | TriFault Detect™ |
|  ™ | MICROCOUPLER™ | SMART START™ | TRUECURRENT™ |
|  ™ | MicroFET™ | SPM® | µSerDes™ |
| Fairchild® | MicroPak™ | STEALTH™ |  SerDes® |
| Fairchild Semiconductor® | MillerDrive™ | SuperFET™ | UHC® |
| FACT Quiet Series™ | MotionMax™ | SuperSOT™.3 | Ultra FRFET™ |
| FACT® | Motion-SPM™ | SuperSOT™.6 | UniFET™ |
| FAST® | OPTOLOGIC® | SuperSOT™.8 | VXC™ |
| FastvCore™ | OPTOPLANAR® | SupreMOS™ | VisualMax™ |
| FETBench™ |  ™ | SyncFET™ | XST™ |
| FlashWriter® | PDP SPM™ | Sync-Lock™ | |
| FPST™ | Power-SPM™ |  SYSTEM GENERAL® | |

* Trademarks of System General Corporation, used under license by Fairchild Semiconductor.

DISCLAIMER

FAIRCHILD SEMICONDUCTOR RESERVES THE RIGHT TO MAKE CHANGES WITHOUT FURTHER NOTICE TO ANY PRODUCTS HEREIN TO IMPROVE RELIABILITY, FUNCTION, OR DESIGN. FAIRCHILD DOES NOT ASSUME ANY LIABILITY ARISING OUT OF THE APPLICATION OR USE OF ANY PRODUCT OR CIRCUIT DESCRIBED HEREIN; NEITHER DOES IT CONVEY ANY LICENSE UNDER ITS PATENT RIGHTS, NOR THE RIGHTS OF OTHERS. THESE SPECIFICATIONS DO NOT EXPAND THE TERMS OF FAIRCHILD'S WORLDWIDE TERMS AND CONDITIONS, SPECIFICALLY THE WARRANTY THEREIN, WHICH COVERS THESE PRODUCTS.

LIFE SUPPORT POLICY

FAIRCHILD'S PRODUCTS ARE NOT AUTHORIZED FOR USE AS CRITICAL COMPONENTS IN LIFE SUPPORT DEVICES OR SYSTEMS WITHOUT THE EXPRESS WRITTEN APPROVAL OF FAIRCHILD SEMICONDUCTOR CORPORATION.

As used herein:

1. Life support devices or systems are devices or systems which, (a) are intended for surgical implant into the body or (b) support or sustain life, and (c) whose failure to perform when properly used in accordance with instructions for use provided in the labeling, can be reasonably expected to result in a significant injury of the user.
2. A critical component in any component of a life support, device, or system whose failure to perform can be reasonably expected to cause the failure of the life support device or system, or to affect its safety or effectiveness.

ANTI-COUNTERFEITING POLICY

Fairchild Semiconductor Corporation's Anti-Counterfeiting Policy. Fairchild's Anti-Counterfeiting Policy is also stated on our external website, www.fairchildsemi.com, under Sales Support.

Counterfeiting of semiconductor parts is a growing problem in the industry. All manufacturers of semiconductor products are experiencing counterfeiting of their parts. Customers who inadvertently purchase counterfeit parts experience many problems such as loss of brand reputation, substandard performance, failed applications, and increased cost of production and manufacturing delays. Fairchild is taking strong measures to protect ourselves and our customers from the proliferation of counterfeit parts. Fairchild strongly encourages customers to purchase Fairchild parts either directly from Fairchild or from Authorized Fairchild Distributors who are listed by country on our web page cited above. Products customers buy either from Fairchild directly or from Authorized Fairchild Distributors are genuine parts, have full traceability, meet Fairchild's quality standards for handling and storage and provide access to Fairchild's full range of up-to-date technical and product information. Fairchild and our Authorized Distributors will stand behind all warranties and will appropriately address any warranty issues that may arise. Fairchild will not provide any warranty coverage or other assistance for parts bought from Unauthorized Sources. Fairchild is committed to combat this global problem and encourage our customers to do their part in stopping this practice by buying direct or from authorized distributors.

PRODUCT STATUS DEFINITIONS

Definition of Terms

Datasheet Identification	Product Status	Definition
Advance Information	Formative / In Design	Datasheet contains the design specifications for product development. Specifications may change in any manner without notice.
Preliminary	First Production	Datasheet contains preliminary data; supplementary data will be published at a later date. Fairchild Semiconductor reserves the right to make changes at any time without notice to improve design.
No Identification Needed	Full Production	Datasheet contains final specifications. Fairchild Semiconductor reserves the right to make changes at any time without notice to improve the design.
Obsolete	Not In Production	Datasheet contains specifications on a product that is discontinued by Fairchild Semiconductor. The datasheet is for reference information only.

Rev. 140