

# MAXIM

## +5V/Adjustable Step-Up Current-Mode DC-DC Converters

MAX731/MAX752

### General Description

The MAX731 and MAX752 are fixed and adjustable CMOS, step-up, DC-DC switch-mode regulators. The MAX731 accepts a positive input voltage between +2.5V and +5.25V and converts it to a fixed +5V at 200mA, guaranteed over temperature. Typical full-load efficiencies are 82% to 87%. It requires a single inductor value of 22 $\mu$ H to function over the entire range, so no inductor-related design is necessary. The MAX752 is an adjustable version that converts a minimum of +1.8V to any higher voltage up to +15V, at up to 200mA. Typical full-load efficiencies are 85% to 95%. A single 50 $\mu$ H inductor is suitable for the entire range of operating conditions, so no inductor-related design is necessary.

The MAX731/MAX752 use current-mode pulse-width modulation (PWM) controllers to provide precise output regulation and low subharmonic noise. Typical no-load supply current is 2mA. A fixed 170kHz oscillator frequency allows easy filtering of ripple and noise, and provides for small external components.

The MAX731/MAX752 feature cycle-by-cycle current limiting, overcurrent limiting, external shutdown, and programmable soft-start protection.

For fixed +12V and +15V step-up regulators, refer to the MAX732/MAX733 data sheet. For lower-power step-up applications, refer to the MAX631/632/633 and MAX654-659 data sheets.

### Applications

+5V-Logic Supply in +3V-Logic System  
DC-DC Converter Module Replacement  
Portable Instruments  
Laptop Computers  
Distributed Power Systems  
Cellular Phones  
Battery-Powered Equipment

### Pin Configurations

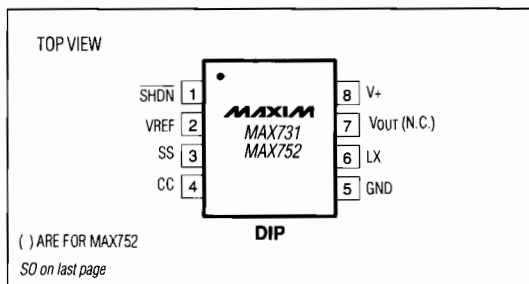

### Features

- ◆ 200mA Load Currents Guaranteed with No External MOSFET
- ◆ Step-Up from a 2.5V Input
- ◆ 170kHz High-Frequency Current-Mode PWM
- ◆ 82% to 87% Typical Efficiencies at Full Load (MAX731)
- ◆ 85% to 95% Typical Efficiencies at Full Load (MAX752)
- ◆ Small Inductor - No Component Design Required
- ◆ 2mA Quiescent Current (MAX752)
- ◆ Overcurrent and Soft-Start Protection
- ◆ 8-Pin DIP, 16-Pin Wide SO Packages
- ◆ Shutdown Pin

### Ordering Information

PART	TEMP. RANGE	PIN-PACKAGE
MAX731CPA	0°C to +70°C	8 Plastic DIP
MAX731CWE	0°C to +70°C	16 Wide SO
MAX731C/D	0°C to +70°C	Dice*
MAX731EPA	-40°C to +85°C	8 Plastic DIP
MAX731EWE	-40°C to +85°C	16 Wide SO
MAX731MJA	-55°C to +125°C	8 CERDIP

Ordering information continued on last page.

\* Dice are tested at  $T_A = +25^\circ\text{C}$  only.

\*\*Contact factory for availability and processing to MIL-STD-883.

### Typical Application Circuit

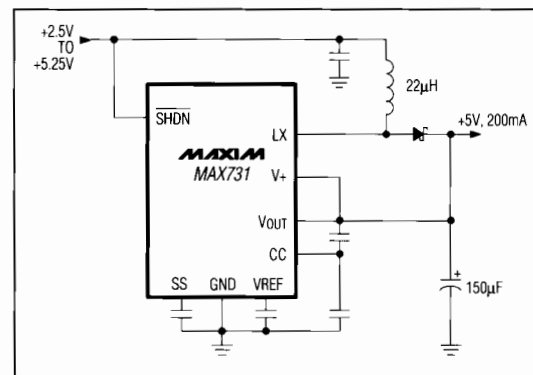

MAXIM

Maxim Integrated Products 1

For free samples & the latest literature: <http://www.maxim-ic.com>, or phone 1-800-998-8800

## +5V/Adjustable Step-Up Current-Mode DC-DC Converters

### ABSOLUTE MAXIMUM RATINGS

V+, LX to GND	-0.3V to +17V
V <sub>OUT</sub> to GND	±25V
SS, CC, SHDN to GND	-0.3V to (V+ + 0.3V)
Peak Switch Current (I <sub>LX</sub> )	1.5A
Reference Current (I <sub>VREF</sub> )	2.5mA
Continuous Power Dissipation (T <sub>A</sub> = +70°C)	
8-Pin Plastic DIP (derate 9.09mW/°C above +70°C)	727mW
16-Pin Wide SO (derate 9.52mW/°C above +70°C)	762mW
8-Pin CERDIP (derate 8.00mW/°C above +70°C)	640mW

### Operating Temperature Ranges:

MAX731/752C	0°C to +70°C
MAX731/752E	-40°C to +85°C
MAX731/752MJA	-55°C to +125°C
Junction Temperatures:	
MAX731/752C_JE	+150°C
MAX731/752MJA	+175°C
Storage Temperature Range	-65°C to +160°C
Lead Temperature (soldering, 10 sec)	+300°C

Stresses beyond those listed under "Absolute Maximum Ratings" may cause permanent damage to the device. These are stress ratings only, and functional operation of the device at these or any other conditions beyond those indicated in the operational sections of the specifications is not implied. Exposure to absolute maximum rating conditions for extended periods may affect device reliability.

### ELECTRICAL CHARACTERISTICS - MAX731

(Circuit of Figure 1a, V<sub>IN</sub> = +3V, I<sub>LOAD</sub> = 0mA, T<sub>A</sub> = T<sub>MIN</sub> to T<sub>MAX</sub>, typical values are at T<sub>A</sub> = +25°C, unless otherwise noted.)

PARAMETER	CONDITIONS	MIN	TYP	MAX	UNITS
Minimum Start-Up Input Voltage	I <sub>LOAD</sub> = 0mA		1.8		V
	I <sub>LOAD</sub> = 200mA		2.0	2.5	
Minimum Operating Voltage, V <sub>IN</sub>	I <sub>LOAD</sub> = 100mA		1.4		V
	I <sub>LOAD</sub> = 200mA		2.0		
Output Voltage (Note 1)	V <sub>IN</sub> = 2.7V to 4.65V, 0mA < I <sub>LOAD</sub> < 200mA	4.75	5.00	5.25	V
Output Current		200			mA
Line Regulation	V <sub>IN</sub> = 2.7V to 4.65V		0.20		%/V
Load Regulation	I <sub>LOAD</sub> = 0mA to 100mA		0.005		%/mA
Efficiency	V <sub>IN</sub> = 3V, I <sub>LOAD</sub> = 100mA		87		%
Supply Current	Includes switch current		2.0	4.0	mA
Standby Current	SHDN = 0, entire circuit		35	100	μA
	SHDN = 0, into V+		6		
Shutdown Input Threshold	V <sub>IH</sub>	V+ - 0.5			V
	V <sub>IL</sub>			0.25	
Shutdown Input Leakage Current				1.0	μA
Short-Circuit Current			1.5		A
LX On Resistance			0.5		Ω
LX Leakage Current	V <sub>D<sub>S</sub></sub> = 5V		1.0		μA
Reference Voltage		1.15	1.23	1.30	V
Reference Drift	T <sub>A</sub> = T <sub>MIN</sub> to T <sub>MAX</sub>		50		ppm/°C
Oscillator Frequency		125	170	215	kHz
Compensation Pin Impedance			20		kΩ

**Note 1:** Circuit will regulate properly with input voltage as high as 5.25V due to voltage drop across the external diode.

## +5V/Adjustable Step-Up Current-Mode DC-DC Converters

### ELECTRICAL CHARACTERISTICS - MAX752

(Circuit of Figure 1b, R1 and R2 configured for +12V output operation,  $V_+ = 5V$ ,  $I_{LOAD} = 0mA$ ,  $T_A = T_{MIN}$  to  $T_{MAX}$ , typical values are at  $T_A = +25^\circ C$ , unless otherwise noted.)

PARAMETER	CONDITIONS		MIN	TYP	MAX	UNITS
Minimum Input Voltage	$I_{LOAD} = 0mA$			1.8	2.5	V
Output Voltage	$V_+ = 4.5V$ to $11.0V$ , $0mA < I_{LOAD} < 150mA$	MAX752C/E	11.46	12.0	12.54	V
	$V_+ = 4.5V$ to $11.0V$ , $0mA < I_{LOAD} < 125mA$	MAX752M	11.46	12.0	12.54	
	$V_+ = 6.0V$ to $11.0V$ , $0mA < I_{LOAD} < 200mA$	MAX752C/E/M	11.46	12.0	12.54	
Output Current	$V_+ = 4.5V$ to $11.0V$	MAX752C/E	150			mA
		MAX752M	125			
	$V_+ = 6.0V$ to $11.0V$	MAX752C/E/M	200			
Output Voltage Range	$V_{IN} \leq V_{OUT}$		2.7		15.75	V
Line Regulation	$V_+ = 4.0V$ to $11.0V$			0.20		%/V
Load Regulation	$I_{LOAD} = 0mA$ to $100mA$			0.0035		%/mA
Efficiency	$V_+ = 5V$ , $I_{LOAD} = 100mA$			88		%
Supply Current	Includes switch current			1.7	3.0	mA
Standby Current	SHDN = 0, entire circuit			70	100	$\mu A$
	SHDN = 0, into $V_+$			6		
Shutdown Input Threshold	$V_{IH}$		$V_+ - 0.5$			V
	$V_{IL}$		0.25			
Shutdown Input Leakage Current					1.0	$\mu A$
Short-Circuit Current				1.5		A
LX On Resistance				0.5		$\Omega$
LX Leakage Current	$V_{DS} = 12V$			1.0		$\mu A$
Reference Voltage			1.15	1.23	1.30	V
Reference Drift	$T_A = T_{MIN}$ to $T_{MAX}$			50		ppm/ $^\circ C$
Oscillator Frequency			130	170	210	kHz

**MAX731/MAX752**

# **+5V/Adjustable Step-Up Current-Mode DC-DC Converters**

## **Typical Operating Characteristics**

**MAX731  
SWITCHING WAVEFORMS  
CONTINUOUS CONDUCTION**

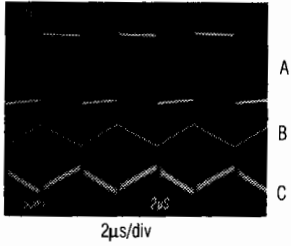

A: Switch Voltage (LX pin), 2V/div, 0V to +5V  
B: Inductor Current, 500mA/div  
C: Output Voltage Ripple, 50mV/div  
Circuit of Fig. 2a,  $C_{OUT} = 150\mu\text{F}$ ,  $V_+ = 3\text{V}$ ,  $I_{OUT} = 200\text{mA}$ ,  $T_A = +25^\circ\text{C}$

**MAX752  
SWITCHING WAVEFORMS  
CONTINUOUS CONDUCTION**

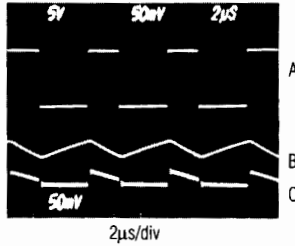

A: Switch Voltage (LX pin), 5V/div, 0V to +12.4V  
B: Inductor Current, 500mA/div  
C: Output Voltage Ripple, 50mV/div  
Circuit of Fig. 2b,  $C_{OUT} = 300\mu\text{F}$ ,  $V_+ = 3\text{V}$ ,  $I_{OUT} = 100\text{mA}$ ,  $T_A = +25^\circ\text{C}$

**MAX731  
SWITCHING WAVEFORMS  
DISCONTINUOUS CONDUCTION**

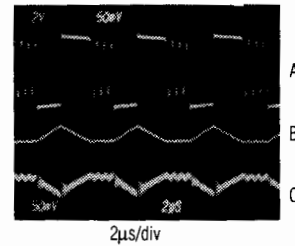

A: Switch Voltage (LX pin), 2V/div, 0V to +5V  
B: Inductor Current, 500mA/div  
C: Output Voltage Ripple, 50mV/div  
Circuit of Fig. 2a,  $C_{OUT} = 150\mu\text{F}$ ,  $V_+ = 3\text{V}$ ,  $I_{OUT} = 100\text{mA}$ ,  $T_A = +25^\circ\text{C}$

**MAX752  
SWITCHING WAVEFORMS  
DISCONTINUOUS CONDUCTION**

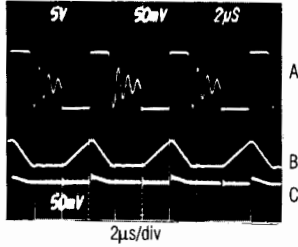

A: Switch Voltage (LX pin), 5V/div, 0V to +12.4V  
B: Inductor Current, 200mA/div  
C: Output Voltage Ripple, 50mV/div  
Circuit of Fig. 2b,  $C_{OUT} = 300\mu\text{F}$ ,  $V_+ = 3\text{V}$ ,  $I_{OUT} = 200\text{mA}$ ,  $T_A = +25^\circ\text{C}$

**MAX731  
LINE TRANSIENT RESPONSE**

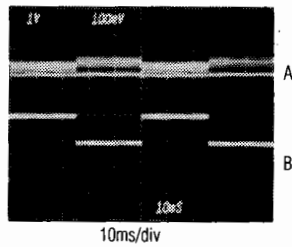

A:  $V_{OUT}$ , 100mV/div  
B:  $V_{IN}$ , 2V to 3V  
Circuit of Fig. 2a,  $I_{LOAD} = 200\text{mA}$ ,  $T_A = +25^\circ\text{C}$

**MAX752  
LINE TRANSIENT RESPONSE**

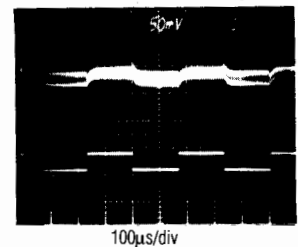

A:  $V_{OUT}$ , 50mV/div, DC-Coupled  
B:  $V_+$ , 5V/div, 6.0V to 9.0V  
Circuit of Fig. 2b,  $I_{OUT} = 200\text{mA}$ ,  $V_{OUT} = 12\text{V}$ ,  $T_A = +25^\circ\text{C}$

**MAX752  
LINE TRANSIENT RESPONSE**

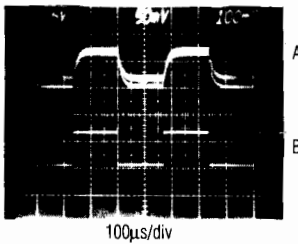

A:  $V_{OUT}$ , 50mV/div, DC-Coupled  
B:  $V_+$ , 5V/div, 6.0V to 12.0V  
Circuit of Fig. 2b,  $I_{OUT} = 125\text{mA}$ ,  $V_{OUT} = 15\text{V}$ ,  $T_A = +25^\circ\text{C}$

**MAX731  
LOAD TRANSIENT RESPONSE**

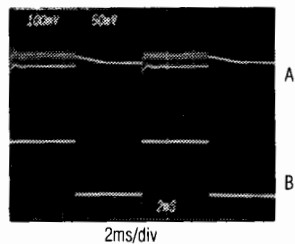

A:  $V_{OUT}$ , 100mV/div  
B:  $I_{OUT}$ , 100mA/div  
Circuit of Fig. 2a,  $T_A = +25^\circ\text{C}$

**MAX752  
LOAD TRANSIENT RESPONSE**

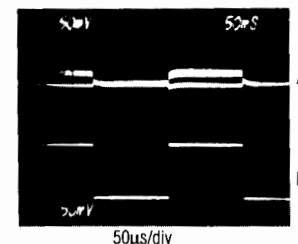

A:  $V_{OUT}$ , 50mV/div, DC-Coupled  
B:  $I_{OUT}$ , 100mA/div, 10mA to 200mA  
Circuit of Fig. 2b,  $V_+ = +6\text{V}$ ,  $T_A = +25^\circ\text{C}$ ,  $V_{OUT} = 12\text{V}$

# +5V/Adjustable Step-Up Current-Mode DC-DC Converters

## Typical Operating Characteristics (continued)

MAX731/MAX752

**MAX752  
LOAD TRANSIENT RESPONSE**

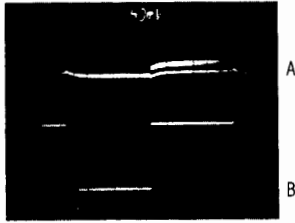

A:  $V_{OUT}$ , 50mV/div, D-C Coupled  
B:  $I_{OUT}$ , 50mA/div, 10mA to 125mA  
Circuit of Fig. 2b,  $V_{+} = +6V$ ,  $T_A = +25^{\circ}C$   
 $V_{OUT} = 15V$

**MAX731  
EFFICIENCY vs. OUTPUT CURRENT**

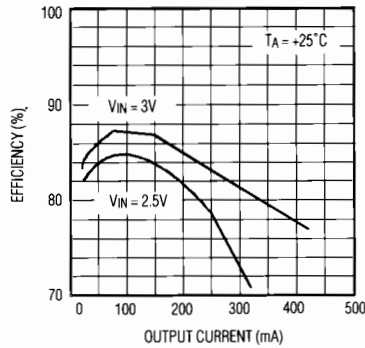

**MAX752  
EFFICIENCY vs. OUTPUT CURRENT**

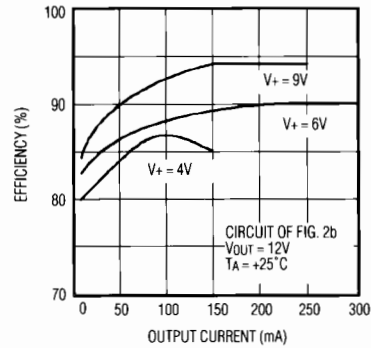

**MAX752  
EFFICIENCY vs. OUTPUT CURRENT**

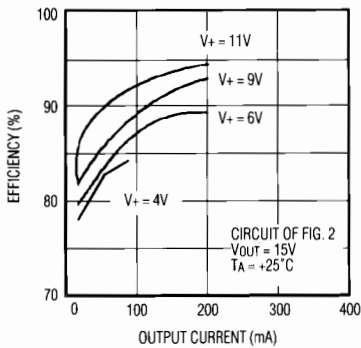

**MAX731  
NO-LOAD SUPPLY CURRENT  
vs. SUPPLY VOLTAGE**

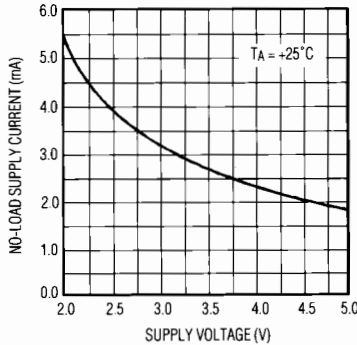

**MAX731  
PEAK INDUCTOR CURRENT AND MAXIMUM  
OUTPUT CURRENT vs. SUPPLY VOLTAGE**

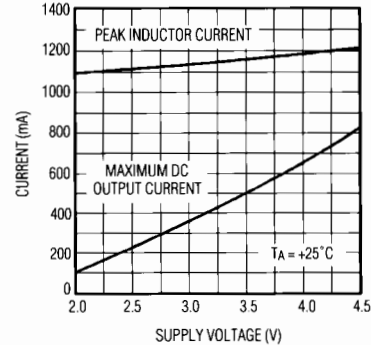

**MAX752 PEAK INDUCTOR CURRENT  
vs. OUTPUT CURRENT**

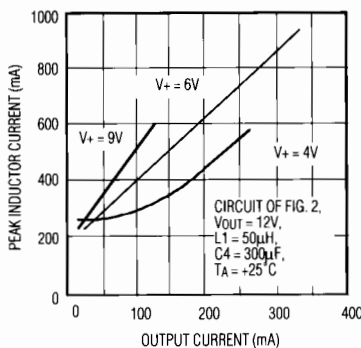

**MAX752  
PEAK INDUCTOR CURRENT vs.  
OUTPUT CURRENT**

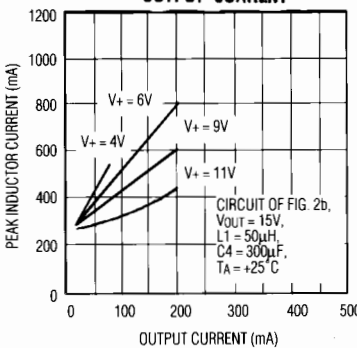

**MAX752 MAXIMUM OUTPUT CURRENT  
vs. SUPPLY VOLTAGE**

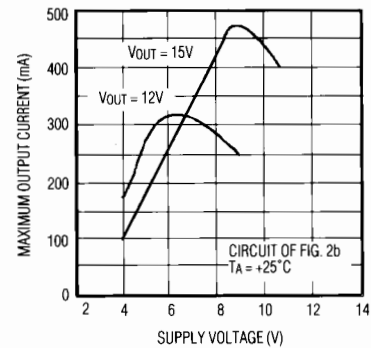

## +5V/Adjustable Step-Up Current-Mode DC-DC Converters

**Table 1a. MAX731 Typical Soft-Start Times**

VIN = 3V, COUT = 150μF	
CSS (μF)	Delay (ms)
0.1	10
0.2	20
0.5	50
1.0	100
2.0	160
5.0	170

**NOTE:** SOFT-START TIMES ARE ±35%. C1 IS THE SOFT-START CAPACITOR; C4 IS THE OUTPUT CAPACITOR

**Table 1b. MAX752 Typical Soft-Start Times**

CIRCUIT CONDITIONS VOUT = +12V, C4 = 300μF		SOFT-START TIME (ms) vs. C1 (μF)		
V+ (V)	IOUT (mA)	0.1μF	0.47μF	1.0μF
4.5	0	55	115	125
6.0	0	40	80	70
9.0	0	30	60	45
4.5	100	90	350	780
6.0	100	60	210	445
9.0	100	30	60	60
4.5	200	175	715	1690
6.0	200	85	340	760
9.0	200	30	75	125

CIRCUIT CONDITIONS VOUT = +15V, C4 = 300μF		SOFT-START TIME (ms) vs. C1 (μF)		
V+ (V)	IOUT (mA)	0.1μF	0.47μF	1.0μF
4.5	0	90	210	250
6.0	0	65	135	150
9.0	0	35	65	50
12.0	0	30	50	35
4.5	75	155	680	1380
6.0	75	105	425	880
9.0	75	45	160	305
12.0	75	30	50	35
4.5	125	235	1125	2260
6.0	125	135	595	1255
9.0	125	55	230	475
12.0	125	30	50	40

**NOTE:** SOFT-START TIMES ARE ±35%. C1 IS THE SOFT-START CAPACITOR; C4 IS THE OUTPUT CAPACITOR



# +5V/Adjustable Step-Up Current-Mode DC-DC Converters

## Pin Description

8-PIN DIP	16-PIN SO	NAME	FUNCTION
	1, 4, 10, 15	N.C.	No Connect - no internal connection
1	2	SHDN	Shutdown - active low. Ground to power-down the IC; tie to V+ for normal operation. Output power FET is held off when SHDN is low.
2	3	VREF	Reference Voltage Output (+1.23V) supplies up to 100µA for external loads.
3	5	SS	Soft-Start. Capacitor between SS and GND provides soft-start and short-circuit protection.
4	6	CC	Compensation Capacitor Input. Externally compensates the outer feedback loop.
5	7	GND	Ground
	8, 9	GND (SW)	Switch Ground - ground of the output power FET. Both pins must be separately tied to ground because they are not internally connected.
6	11, 12, 13	LX	Drain of internal N-channel power MOSFET
7	14	Vout	Output-Voltage Sense Input (MAX731)
		N.C.	No Connect - no internal connection (MAX752)
8	16	V+	Supply Voltage Input

**MAX731/MAX752**

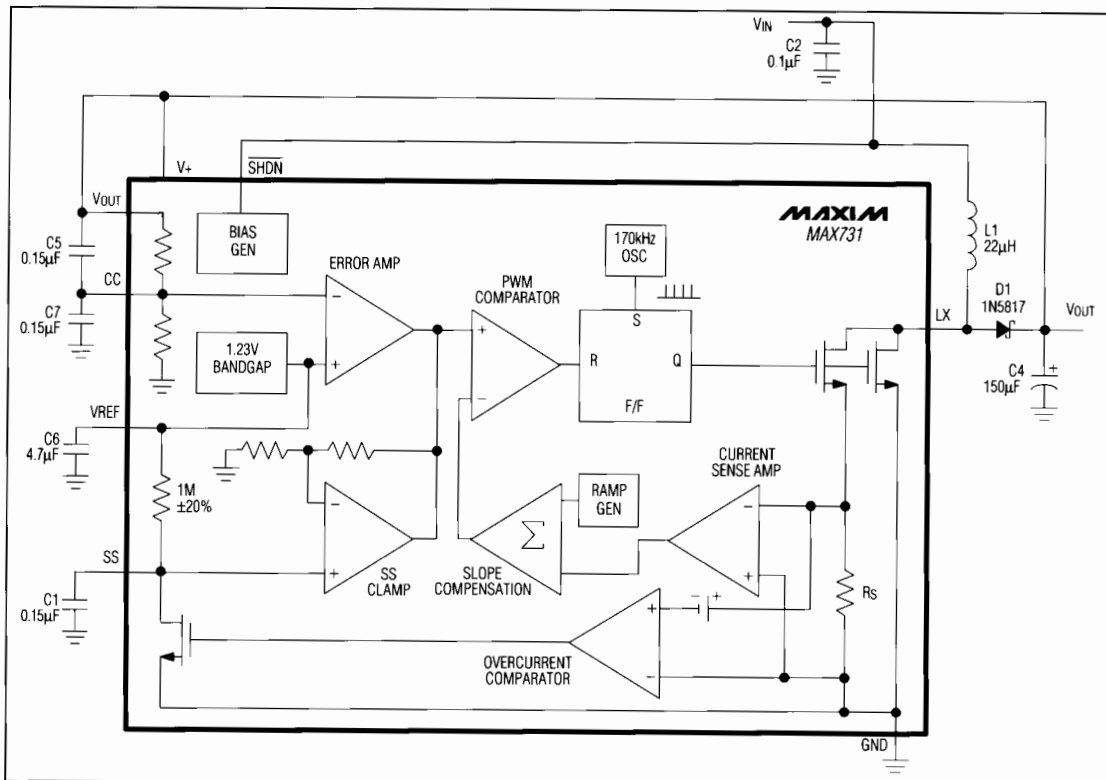

Figure 1a. MAX731 Detailed Block Diagram with External Components, Bootstrap Mode

**MAXIM**

7

## +5V/Adjustable Step-Up Current-Mode DC-DC Converters

MAX731/MAX752

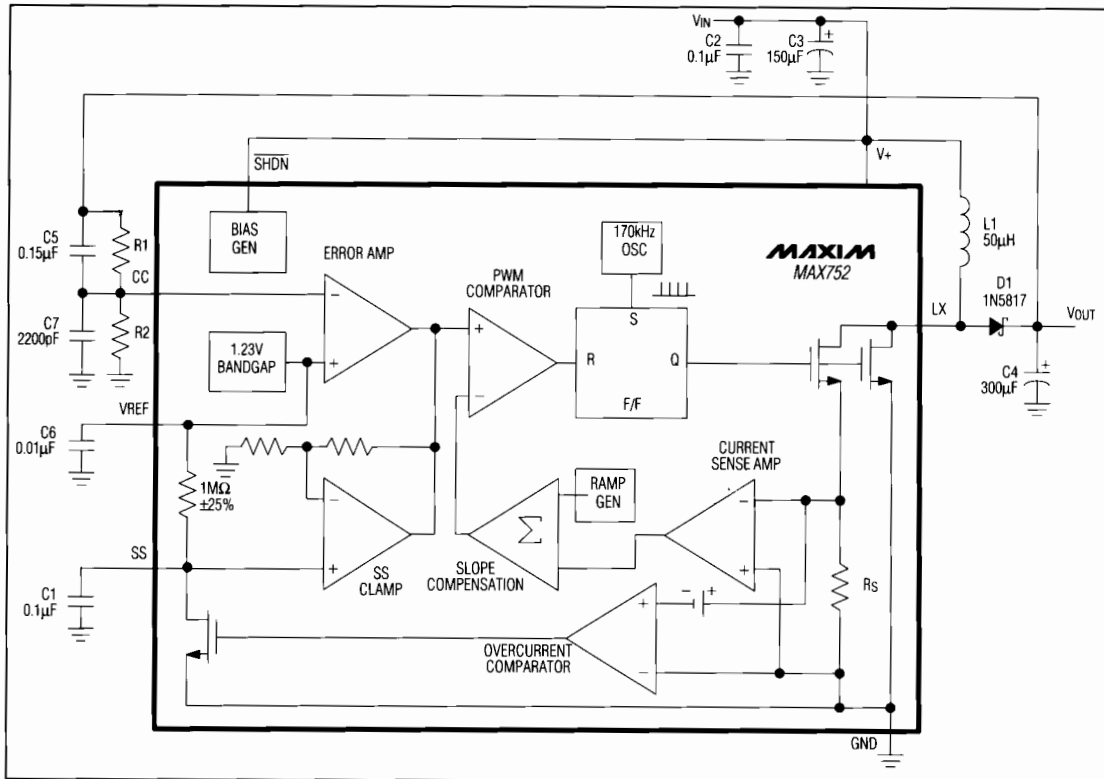

Figure 1b. MAX752 Detailed Block Diagram with External Components, Optimized for 12V Output.

### Detailed Description

The input voltage range has three important components: no-load starting voltage, full-load starting voltage and minimum operating voltage. The no-load starting voltage is usually less than 2.0V, but if a load is added, the circuit may not start. At a slightly higher voltage, more current can be drawn, and the output voltage will rise to the regulated value. With a 2.5V input voltage, the MAX731 will start up and regulate with a 200mA load. The MAX752 will start up and regulate at 12V at 150mA from a minimum input voltage of 4.5V.

The MAX731 has a "bootstrapped" output, which means it operates from the output that it generates. Once it generates 5V, it then operates from this 5V, and subse-

quently can furnish 200mA from an input as low as 2.0V (the holding voltage). The holding voltage is typically 1.4V for 100mA loads. This capability is very important in battery-operated equipment, because it indicates the voltage to which the battery can discharge without losing output regulation.

Input voltages as high as 16V can be applied without damage, but regulation is lost when the input exceeds the normal regulated output. This happens because a DC path through the inductor and diode produces an output voltage one diode drop (0.3-0.6V) less than the input voltage. (The MAX731/MAX752 sense this high output and stop switching.) This path exists even with the IC removed from the circuit.



## +5V/Adjustable Step-Up Current-Mode DC-DC Converters

**MAX731/MAX752**

### Operating Principle

The MAX731/MAX752 switch-mode regulators use a current-mode pulse-width modulation (PWM) controller coupled with a simple boost regulator topography to step up an unregulated DC voltage. The MAX731 converts a voltage ranging from 1.4V to 5.25V to 5V. The MAX752 has an adjustable output. The current-mode PWM architecture provides cycle-by-cycle current limiting and excellent load-transient response characteristics.

The controller consists of two feedback loops: an inner (current) loop that monitors the switch current through the current-sense resistor (RS) and amplifier, and an outer (voltage) loop that monitors the output voltage through the error amplifier (Figure 1). The inner loop performs cycle-by-cycle current limiting, truncating the power transistor on-time when the switch current reaches a threshold determined by the outer loop. For example, a sagging output voltage produces an error signal that raises the threshold, allowing the circuit to store and transfer more energy during each cycle.

### Programmable Soft Start

A capacitor between 0.1µF and 5µF is required on the Soft-Start (SS) pin to ensure an orderly power-up. The charging capacitor's voltage slowly raises the clamp on the error-amplifier output voltage, limiting surge currents at power-up by slowly increasing the cycle-by-cycle current-limit threshold. SS timing is controllable from the SS pin by capacitor choice. A typical value is 0.1µF. Table 1 lists timing characteristics for selected capacitor values and circuit conditions.

The output voltage sags if more than the maximum load current is drawn. The overcurrent comparator trips if the load exceeds approximately 1.5A. An SS cycle is actively initiated when an overcurrent fault condition triggers an internal transistor to discharge the SS capacitor to ground.

### Overcurrent Limiting

When the load current exceeds approximately 1.5A, the output stage is turned off by the inner loop cycle-by-cycle current-limiting action, and the overcurrent comparator signals the control logic to initiate an SS cycle. On each clock cycle, the output FET turns on again and attempts to deliver current until cycle-by-cycle or overcurrent limits are exceeded. Note that the SS capacitor must be at least 0.01µF for overcurrent protection to function properly.

### Shutdown

Keeping the Shutdown ( $\overline{\text{SHDN}}$ ) pin at ground holds the MAX731/MAX752 in shutdown mode. In shutdown mode, the output power FET is off, but there is still an external path from V+ to the load through the inductor and diode, and another path from V+ to GND through the inductor, diode, and external feedback resistors. For the MAX731, the

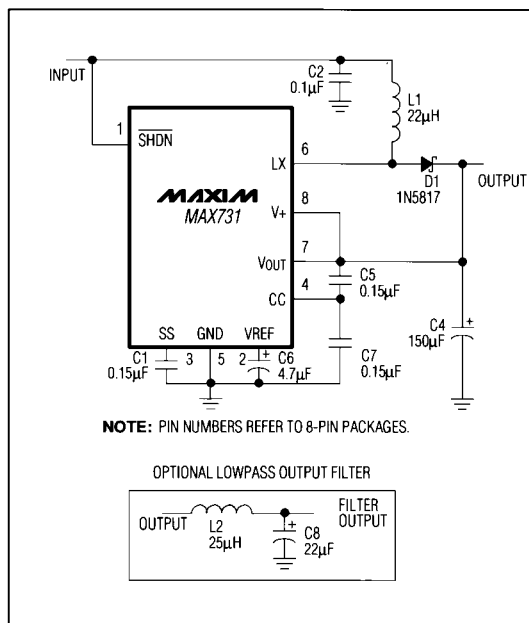

Figure 2a. MAX731 Standard Boost Application Circuit

feedback resistors are approximately 80kΩ. The internal reference turns off, which causes the SS capacitor to discharge. Typical device standby current in shutdown mode is 35µA. For normal operation, connect  $\overline{\text{SHDN}}$  to V+. An SS cycle brings the MAX731 out of shutdown mode.

The +1.23V bandgap reference supplies up to 100µA at VREF. A bypass capacitor from VREF to GND is required: 4.7µF for the MAX731 and 0.01µF for the MAX752.

### Output Adjustment - MAX752

The output voltage for the MAX752 is set by two resistors, R1 and R2 (Figures 1b and 2b), which form a voltage divider between the output and the Compensation Capacitor (CC) pin. The regulator adjusts the output so the voltage at the junction of R1 and R2 is equal to the +1.23V bandgap reference voltage. Since CC is a CMOS input, its input impedance is nearly an open circuit, which will not load the voltage divider. R2 can be any value between 10kΩ to 30kΩ. R1 is given by the formula:

$$R1 = R2 \left( \frac{V_{\text{OUT}}}{1.23\text{V}} - 1 \right)$$

Capacitors C5 and C7 furnish loop compensation. Smaller values are not recommended because they may produce instability.

## +5V/Adjustable Step-Up Current-Mode DC-DC Converters

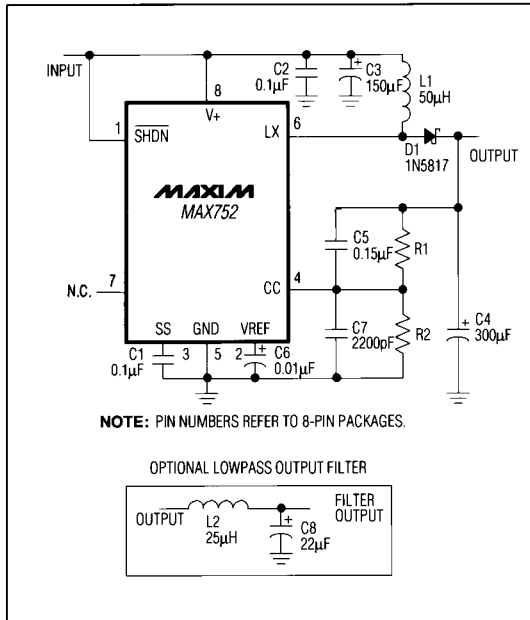

Figure 2b. MAX752 Standard Boost Application Circuit

### Modes

**Continuous-Current Mode:** The MAX731/MAX752 normally operate in continuous-current mode, which means current always flows in the inductor, and the control circuit adjusts the switch's duty cycle on a cycle-by-cycle basis to maintain regulation without exceeding the switch current capability. This mode provides excellent load-transient response. During start-up conditions and under very light loads, this method cannot adjust the duty cycle to the correct value without exceeding the switch current capability, so the controller changes to discontinuous-current mode.

**Discontinuous-Current Mode:** In discontinuous-current mode, current through the inductor starts at zero, rises to a peak value, then ramps down to zero on each cycle. Although efficiency is still excellent, the output ripple increases slightly and the switch waveforms display ringing (the inductor's self-resonant frequency). This ringing may seem disconcerting at first, but it does not indicate problems.

**Pulse-Skipping Mode:** At load currents under a few milliamperes, even discontinuous-current mode tends to put more energy into the coil than the load requires, so the controller changes to pulse-skipping mode, in which

regulation is achieved by skipping entire cycles. Efficiency is still good, typically 70% to 80%, reduced in part because the MAX731/MAX752 quiescent supply current becomes a significantly larger fraction of the total current when load currents are low. Pulse-skipping switch waveforms can be irregular, and the output ripple contains a low-frequency component that may exceed 50mV. Larger, low-ESR filter capacitors can help reduce the ripple voltage in critical applications.

The MAX731/MAX752 controller normally operates in continuous-current mode and reverts to discontinuous-current mode or pulse-skipping mode during extreme conditions. Continuous-current mode operation gives a cleaner output than discontinuous or pulse-skipping modes, because peak-to-peak ripple amplitude is minimized and the ripple frequency is fixed at the oscillator frequency, making the output easy to filter.

It is possible to design circuits around the MAX731 that use discontinuous-current mode as the primary means of regulation, eliminating the compensation capacitor shown in Figure 2. This is not normally recommended for several reasons. First, the peak currents in the switch and the inductor become much higher, reducing the output current. Second, the coil's inductance, peak current rating, and resistance values become critical; its physical size increases as well. Finally, the output filter requirements demand larger components.

### Application Information

For fixed outputs of 12V or 15V, the MAX732 or MAX733 can be used. These devices are fully characterized at these voltages at output currents up to 200mA (125mA for MAX733), and do not require external voltage dividers. They accept input voltages above 4.0V.

Figure 2a shows the standard step-up application circuit. This circuit will operate with inputs from 2.5V to 5.25V. The output current depends on the input voltage (see Maximum Output Current vs. Supply Voltage, *Typical Operating Characteristics*).

### Inductor Selection

A 22µH inductor is sufficient for most MAX731 designs and a 50µH inductor is sufficient for most MAX752 designs. The important specification is the inductor's incremental saturation current rating, which should be greater than 2.5 times the DC load current (500mA for 12V, 200mA loads). For lower-power applications, smaller inductor values may be used. Table 2 shows recommended inductor types and suppliers for various applications. The listed surface-mount inductors' efficiencies are nearly equivalent to those of the larger-sized, through-hole inductors.

## +5V/Adjustable Step-Up Current-Mode DC-DC Converters

**MAX731/MAX752**

**Table 2. Component Suppliers**

PRODUCTION METHOD	INDUCTORS	CAPACITORS
Surface Mount	Sumida For MAX731: CD54-220 (22 $\mu$ H) For MAX752: CD54-220 (22 $\mu$ H) CD54-470 (47 $\mu$ H) for discontinuous mode  Coiltronics CTX 100-series	Matsuo  267-series
Miniature Through-Hole	Sumida For MAX731: RCH654-220 For MAX752: RCH654-470	Sanyo OS-CON OS-CON-series Low ESR Organic Semiconductor
Low-Cost Through-Hole	Renco For MAX731: RL 1284-22 For MAX752: RL1284-47	Maxim MAXC001 150 $\mu$ F, Low ESR Electrolytic  Nichicon PL-series Low ESR Electrolytics  United Chemi-Con LXF-series

Sumida (708) 956-0666

Renco (516) 585-5566

Sanyo OS-CON (619) 661-6835

Coiltronics (516) 241-7876

Matsuo USA (714) 969-2491

Matsuo Japan (06) 332-0871

United Chemi-Con (708) 696-2000

Nichicon (708) 843-7500

### Output Filter Capacitor Selection

The primary criterion for selecting the output filter capacitor is low equivalent series resistance (ESR). The product of the inductor current variation and the output capacitor's ESR determines the high-frequency amplitude seen on the output voltage. The capacitor's ESR should be less than 0.25 $\Omega$  to keep the output ripple less than 50mV<sub>p-p</sub> over the entire current range (using the recommended inductor). In addition, the output filter capacitor's ESR should be minimized to maintain AC stability. Refer to Table 2 for suggested capacitor suppliers.

In the standard application of Figure 2, the output capacitor value should be at least 300 $\mu$ F in order to maintain stability at full loads. 150 $\mu$ F capacitors (MAXC001) are available from Maxim in production quantities. Two of these capacitors can be connected in parallel. Lighter loads require proportionately lower capacitor values.

### Other Components

Use a Schottky diode with a current rating of at least 500mA for full-load (200mA) operation. The 1N5817 is a good choice. The two compensation capacitor values at the CC input are critical because they have been selected to provide the best transient response.

### Output-Ripple Filtering

An optional lowpass pi-filter (Figure 2) can be added to the output to reduce output ripple to about 5mV<sub>p-p</sub>. The cutoff frequency of the filter shown is 21kHz. Since the filter inductor is in series with the circuit output, its resistance should be minimized to avoid excessive voltage drop. Note that the feedback must be taken before the filter, not after the filter.

### Printed Circuit Layout

Printed circuit board layout is not critical, except to ensure quiet operation. Bypass capacitors should be located as close to the device as possible to prevent instability and noise pickup. The Schottky diode leads should also be kept short to prevent fast rise-time pulses in the output. A ground plane is recommended but not necessary.

### V+ Bypassing

**For MAX752 applications where greater than 13V is generated with more than 100mA load current, capacitor C2 (Fig2b) should be located less than 1/2 inch from V+ and GND pins of the IC. This capacitor snubs high voltages created by large load transients.**

# +5V/Adjustable Step-Up Current-Mode DC-DC Converters

## Pin Configurations (continued)

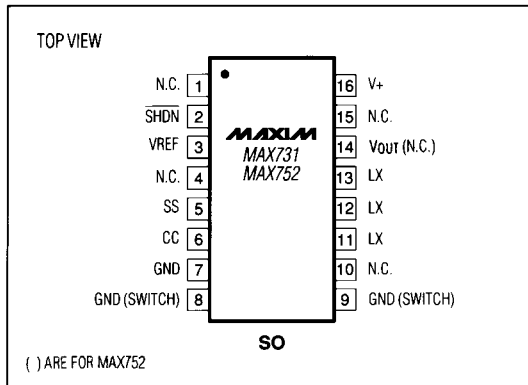

## Ordering Information (continued)

PART	TEMP. RANGE	PIN-PACKAGE
MAX752CPA	0°C to +70°C	8 Plastic DIP
MAX752CWE	0°C to +70°C	16 Wide SO
MAX752C/D	0°C to +70°C	Dice*
MAX752EPA	-40°C to +85°C	8 Plastic DIP
MAX752EWE	-40°C to +85°C	16 Wide SO
MAX752MJA	-55°C to +125°C	8 CERDIP**

\* Dice are tested at  $T_A = +25^\circ\text{C}$  only.

\*\*Contact factory for availability and processing to MIL-STD-883.

## Chip Topographies

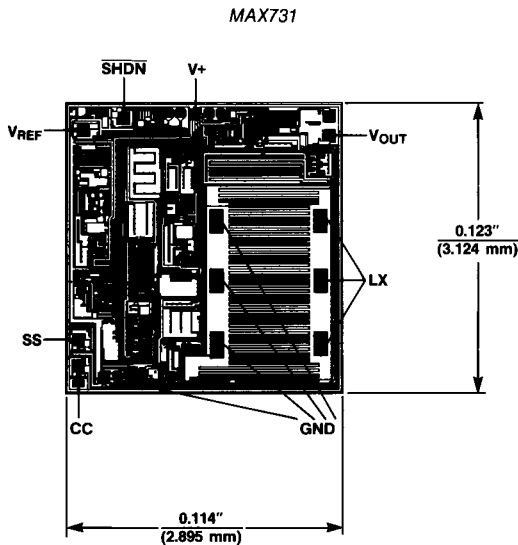

**NOTE:** CONNECT SUBSTRATE TO V+  
TRANSISTOR COUNT: 228

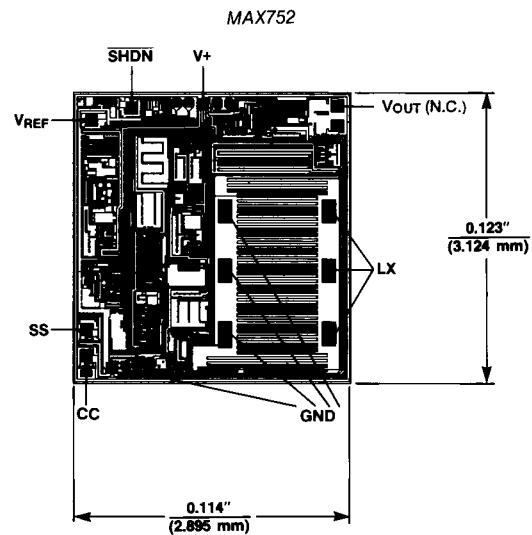

**NOTE:** CONNECT SUBSTRATE TO V+  
TRANSISTOR COUNT: 228

Maxim cannot assume responsibility for use of any circuitry other than circuitry entirely embodied in a Maxim product. No circuit patent licenses are implied. Maxim reserves the right to change the circuitry and specifications without notice at any time.

12 **Maxim Integrated Products, 120 San Gabriel Drive, Sunnyvale, CA 94086 (408) 737-7600**

© 1996 Maxim Integrated Products

Printed USA

**MAXIM** is a registered trademark of Maxim Integrated Products.