

**NOT RECOMMENDED FOR NEW DESIGNS  
PIN COMPATIBLE REPLACEMENT IS  
ISL97516**

**600kHz/1.2MHz PWM Step-Up Regulator**

The EL7516 is a high frequency, high efficiency step-up voltage regulator operated at constant frequency PWM mode. With an internal 1.5A, 200mΩ MOSFET, it can deliver up to 600mA output current at over 90% efficiency. The selectable 600kHz and 1.2MHz allows smaller inductors and faster transient response. An external compensation pin gives the user greater flexibility in setting frequency compensation allowing the use of low ESR Ceramic output capacitors.

When shut down, it draws <10µA of current and can operate down to 2.5V input supply. These features along with 1.2MHz switching frequency makes it an ideal device for portable equipment and TFT-LCD displays.

The EL7516 is available in an 8 Ld MSOP package with a maximum height of 1.1mm. The device is specified for operation over the full -40°C to +85°C temperature range.

**Pinout**

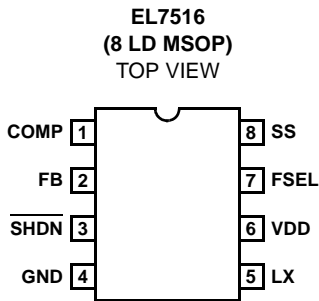

**Features**

- >90% efficiency
- 1.6A, 200mΩ power MOSFET
- $V_{IN} > 2.5V$
- 600kHz/1.2MHz switching frequency selection
- Adjustable soft-start
- Internal thermal protection
- 1.1mm max height 8 Ld MSOP package
- Pb-free plus anneal available (RoHS compliant)

**Applications**

- TFT-LCD displays
- DSL modems
- PCMCIA cards
- Digital cameras
- GSM/CDMA phones
- Portable equipment
- Handheld devices

**Ordering Information**

PART NUMBER	PART MARKING	TAPE & REEL	PACKAGE	PKG. DWG. #
EL7516IY	f	-	8 Ld MSOP	MDP0043
EL7516IY-T7	f	7"	8 Ld MSOP	MDP0043
EL7516IY-T13	f	13"	8 Ld MSOP	MDP0043
EL7516IYZ (Note)	BARAA	-	8 Ld MSOP (Pb-Free)	MDP0043
EL7516IYZ-T7 (Note)	BARAA	7"	8 Ld MSOP (Pb-Free)	MDP0043
EL7516IYZ-T13 (Note)	BARAA	13"	8 Ld MSOP (Pb-Free)	MDP0043

NOTE: Intersil Pb-free plus anneal products employ special Pb-free material sets; molding compounds/die attach materials and 100% matte tin plate termination finish, which are RoHS compliant and compatible with both SnPb and Pb-free soldering operations. Intersil Pb-free products are MSL classified at Pb-free peak reflow temperatures that meet or exceed the Pb-free requirements of IPC/JEDEC J STD-020.

**Absolute Maximum Ratings** ( $T_A = +25^\circ\text{C}$ )

LX to GND	18V
$V_{DD}$ to GND	6.5V
COMP, FB, SHDN, SS, FSEL to GND	-0.3V to ( $V_{DD} + 0.3V$ )

**Thermal Information**

Storage Temperature	-65°C to +150°C
Operating Ambient Temperature	-40°C to +85°C
Operating Junction Temperature	+135°C
Power Dissipation	See Curves

CAUTION: Stresses above those listed in "Absolute Maximum Ratings" may cause permanent damage to the device. This is a stress only rating and operation of the device at these or any other conditions above those indicated in the operational sections of this specification is not implied.

IMPORTANT NOTE: All parameters having Min/Max specifications are guaranteed. Typical values are for information purposes only. Unless otherwise noted, all tests are at the specified temperature and are pulsed tests, therefore:  $T_J = T_C = T_A$

**Electrical Specifications**  $V_{IN} = 3.3V$ ,  $V_{OUT} = 12V$ ,  $I_{OUT} = 0mA$ , FSEL = GND,  $T_A = +25^\circ\text{C}$  unless otherwise specified.

PARAMETER	DESCRIPTION	CONDITIONS	MIN	TYP	MAX	UNIT
IQ1	Quiescent Current - Shut-down	$\overline{\text{SHDN}} = 0V$		0.6	10	$\mu\text{A}$
IQ2	Quiescent Current - Not Switching	$\overline{\text{SHDN}} = V_{DD}$ , FB = 1.3V		0.7		mA
IQ3	Quiescent Current - Switching	$\overline{\text{SHDN}} = V_{DD}$ , FB = 1.0V		1.3	2	mA
$V_{FB}$	Feedback Voltage		1.272	1.294	1.309	V
$I_{B-FB}$	Feedback Input Bias Current			0.01	0.5	$\mu\text{A}$
$V_{DD}$	Start-Up Input Voltage Range		2.6		5.5	V
$D_{MAX} - 600\text{kHz}$	Maximum Duty Cycle	FSEL = 0V	84	90		%
$D_{MAX} - 1.2\text{MHz}$	Maximum Duty Cycle	FSEL = $V_{DD}$	84	90		%
$I_{LIM}$	Current Limit - Max Peak Input Current		1.3	1.5		A
$I_{\overline{\text{SHDN}}}$	Shut-down Input Bias Current	$\overline{\text{SHDN}} = 0V$		0.01	0.1	$\mu\text{A}$
$r_{DS-ON}$	Switch ON-Resistance	$V_{DD} = 2.7V$ , $I_{LX} = 1A$		0.2		$\Omega$
$I_{LX-LEAK}$	Switch Leakage Current	VSW = 18V		0.01	3	$\mu\text{A}$
$\Delta V_{OUT}/\Delta V_{IN}$	Line Regulation	$3V < V_{IN} < 5.5V$ , $V_{OUT} = 12V$		0.1		%
$\Delta V_{OUT}/\Delta I_{OUT}$	Load Regulation	$V_{IN} = 3.3V$ , $V_{OUT} = 12V$ , $I_O = 30\text{mA}$ to 200mA		6.7		mV/A
$f_{OSC1}$	Switching Frequency Accuracy	FSEL = 0V	500	620	740	kHz
$f_{OSC2}$	Switching Frequency Accuracy	FSEL = $V_{DD}$	1000	1250	1500	kHz
$V_{IL}$	$\overline{\text{SHDN}}$ , FSEL Input Low Level				0.5	V
$V_{IH}$	$\overline{\text{SHDN}}$ , FSEL Input High Level		2.7			V
$V_{IL}$	$\overline{\text{SHDN}}$ , Input Low Level	5V Input Supply			1.25	V
$V_{IH}$	$\overline{\text{SHDN}}$ , Input High Level	5V Input Supply	4.5			V
$G_M$	Error Amp Transconductance	$\Delta I = 5\mu\text{A}$	90	130	170	$1\mu\Omega$
$A_V$	Voltage Gain			350		V/V
$V_{DD-ON}$	$V_{DD}$ UVLO On Threshold		2.40	2.51	2.60	V
$V_{DD-OFF}$	$V_{DD}$ UVLO Off Threshold		2.20	2.30	2.40	V
$I_{SS}$	Soft-start Charge Current		4	6	8	$\mu\text{A}$
$R_{CS}$	Current Sense Transresistance			0.08		V/A
OTP	Over-temperature Protection			130		$^\circ\text{C}$

Block Diagram

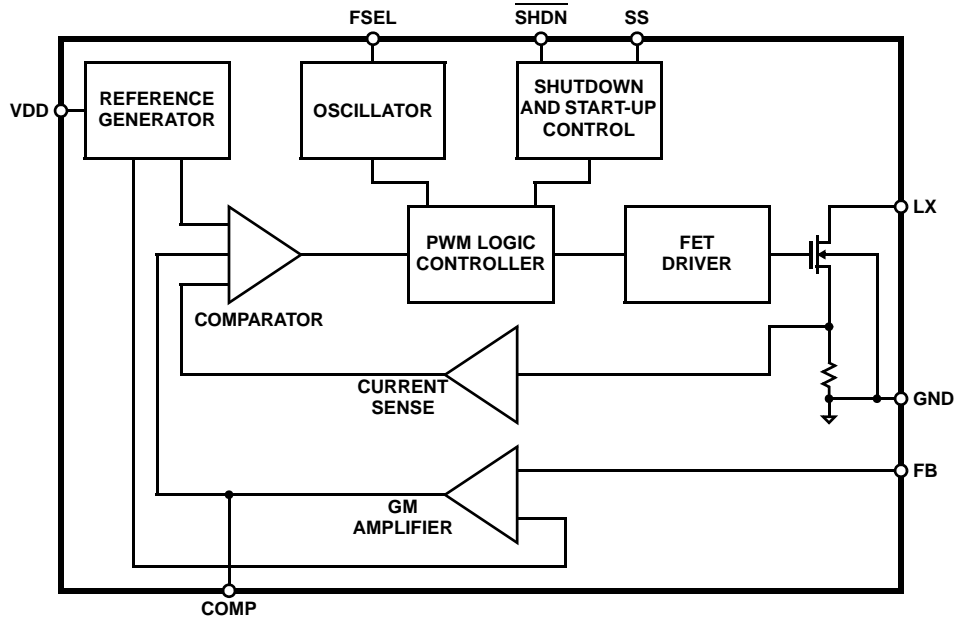

Pin Descriptions

PIN NUMBER	PIN NAME	DESCRIPTION
1	COMP	Compensation pin. Output of the internal error amplifier. Capacitor and resistor from COMP pin to ground.
2	FB	Voltage feedback pin. Internal reference is 1.294V nominal. Connect a resistor divider from $V_{OUT}$ . $V_{OUT} = 1.294V (1 + R_1/R_2)$ . See Typical Application Circuit.
3	$\overline{\text{SHDN}}$	Shutdown control pin. Pull $\overline{\text{SHDN}}$ low to turn off the device.
4	GND	Analog and power ground.
5	LX	Power switch pin. Connected to the drain of the internal power MOSFET.
6	VDD	Analog power supply input pin.
7	FSEL	Frequency select pin. When FSEL is set low, switching frequency is set to 620kHz. When connected to high or $V_{DD}$ , switching frequency is set to 1.25MHz.
8	SS	Soft-start control pin. Connect a capacitor to control the converter start-up.

Typical Application Circuit

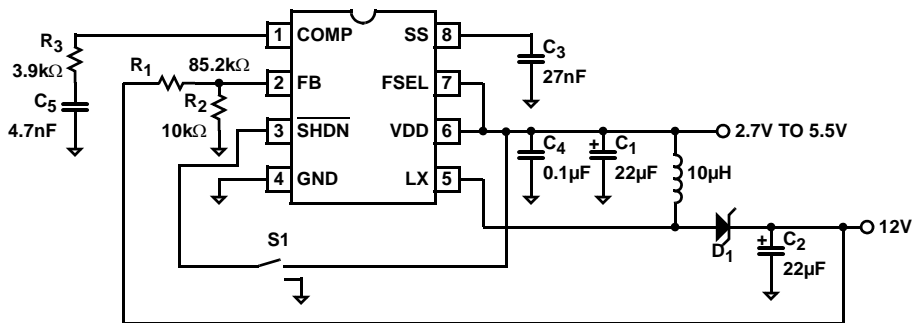

Typical Performance Curves

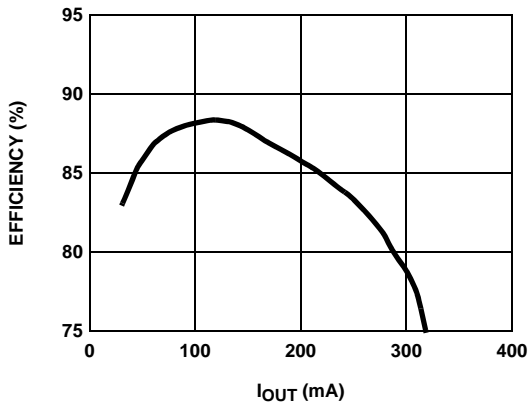

FIGURE 1. EFFICIENCY - 3.3V  $V_{IN}$  TO 12V  $V_{OUT}$  @ 1.3MHz

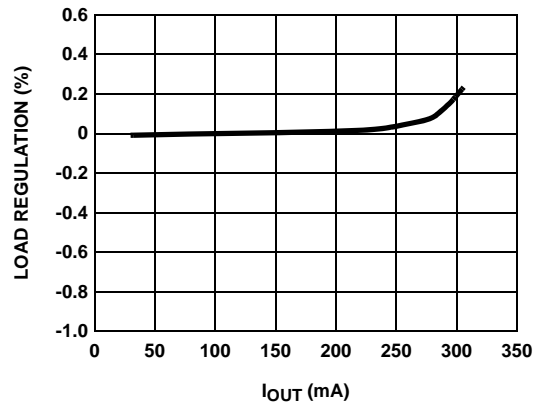

FIGURE 2. LOAD REGULATION - 3.3V  $V_{IN}$  TO 12V  $V_{OUT}$  @ 1.3MHz

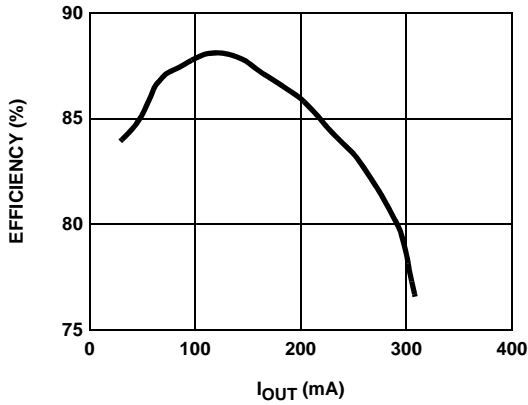

FIGURE 3. EFFICIENCY - 3.3V  $V_{IN}$  TO 12V  $V_{OUT}$  @ 620kHz

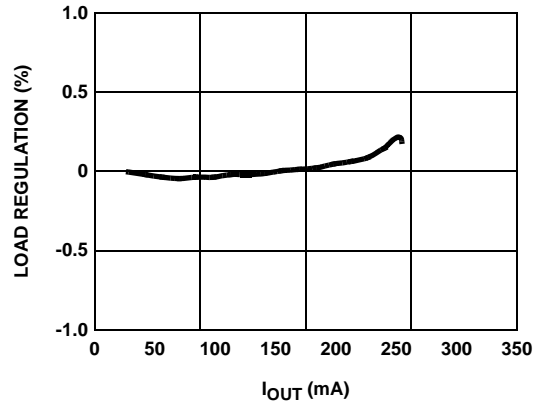

FIGURE 4. LOAD REGULATION - 3.3V  $V_{IN}$  TO 12V  $V_{OUT}$  @ 620kHz

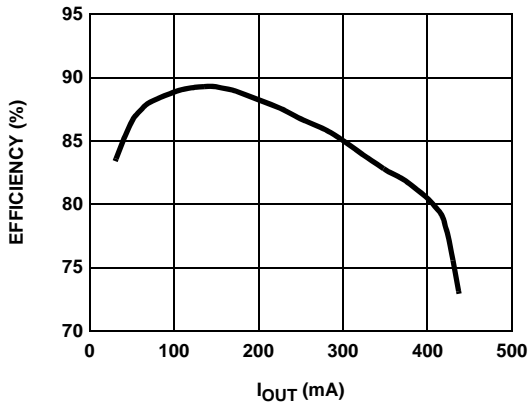

FIGURE 5. EFFICIENCY - 3.3V  $V_{IN}$  TO 9V  $V_{OUT}$  @ 1.2MHz

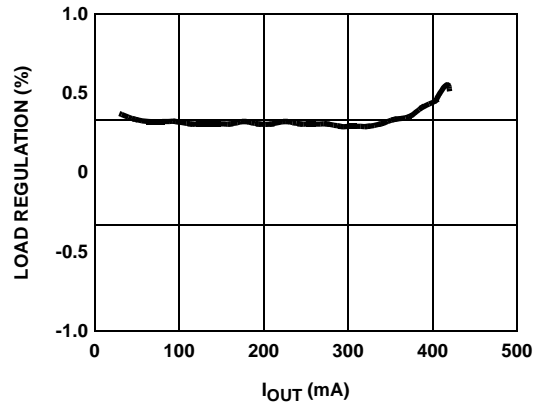

FIGURE 6. LOAD REGULATION - 3.3V  $V_{IN}$  TO 9V  $V_{OUT}$  @ 1.2MHz

Typical Performance Curves (Continued)

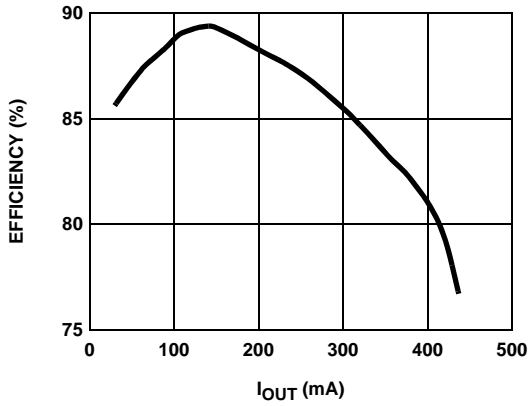

FIGURE 7. EFFICIENCY - 3.3V V<sub>IN</sub> TO 9V V<sub>OUT</sub> @ 600kHz

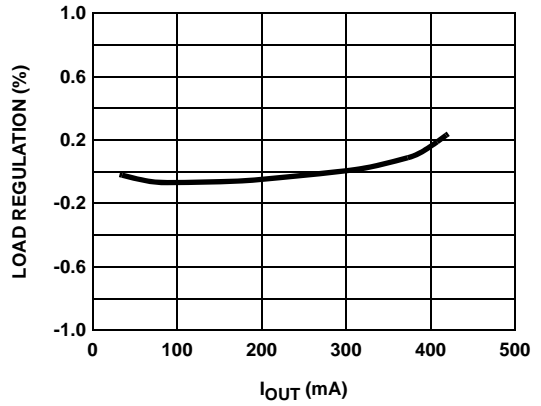

FIGURE 8. LOAD REGULATION - 3.3V V<sub>IN</sub> TO 9V V<sub>OUT</sub> @ 600kHz

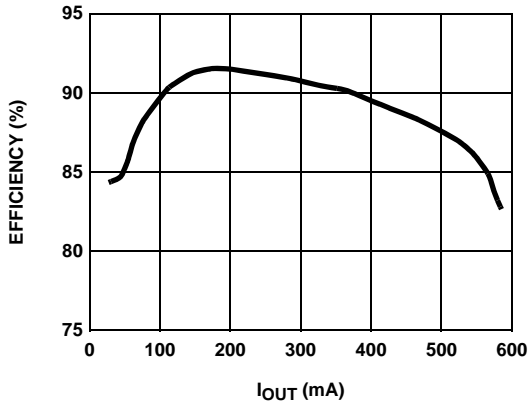

FIGURE 9. EFFICIENCY - 5V V<sub>IN</sub> TO 12V V<sub>OUT</sub> @ 1.2MHz

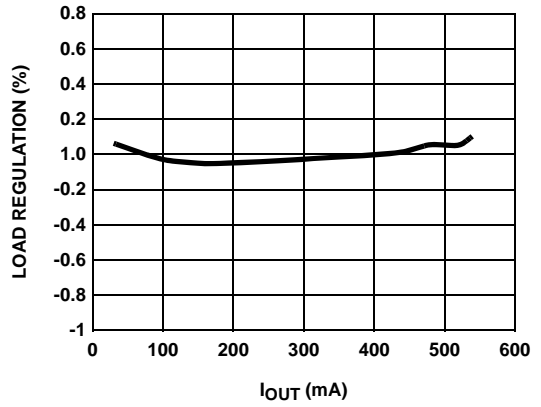

FIGURE 10. LOAD REGULATION - 5V V<sub>IN</sub> TO 12V V<sub>OUT</sub> @ 1.2MHz

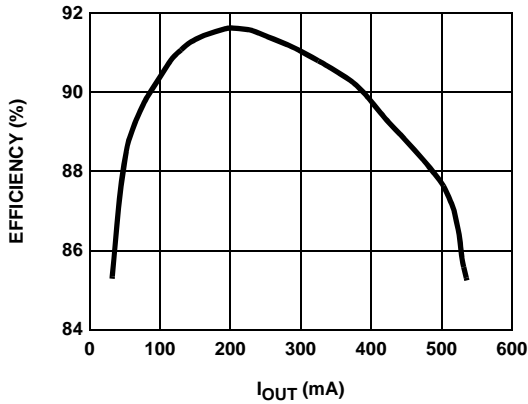

FIGURE 11. EFFICIENCY - 5V V<sub>IN</sub> TO 12V V<sub>OUT</sub> @ 600kHz

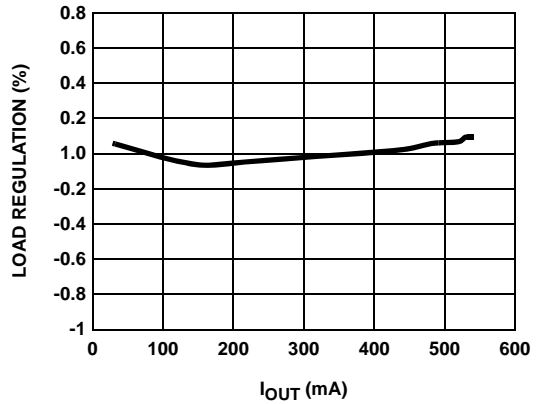

FIGURE 12. LOAD REGULATION - 5V V<sub>IN</sub> TO 12V V<sub>OUT</sub> @ 600kHz

Typical Performance Curves (Continued)

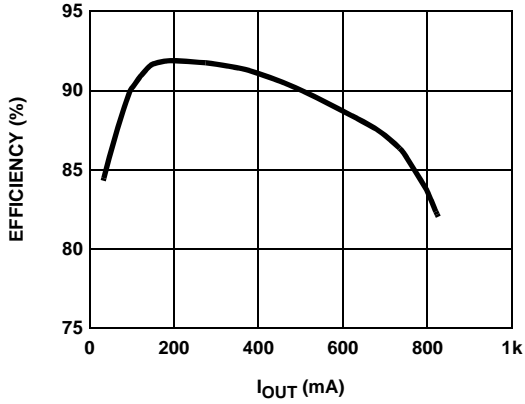

FIGURE 13. EFFICIENCY - 5V VIN TO 9V VOUT @ 1.2MHz

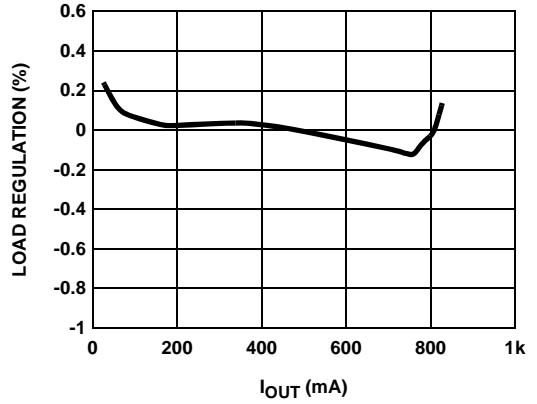

FIGURE 14. LOAD REGULATION - 5V VIN TO 9V VOUT @ 1.2MHz

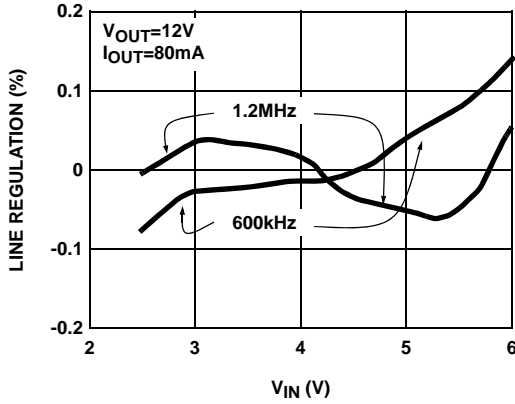

FIGURE 15. LINE REGULATION

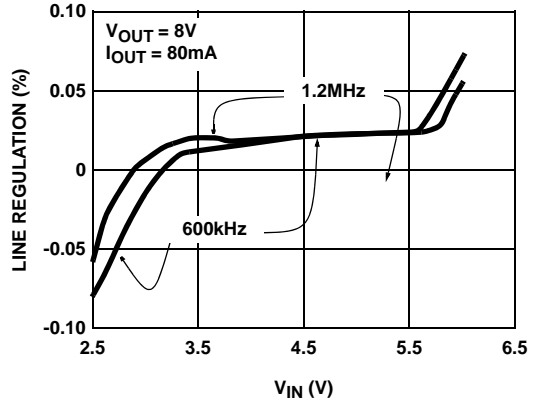

FIGURE 16. LINE REGULATION

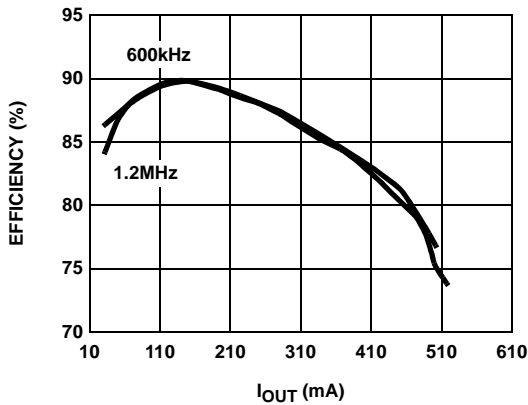

FIGURE 17. EFFICIENCY vs IOUT - 3.3V TO 8V

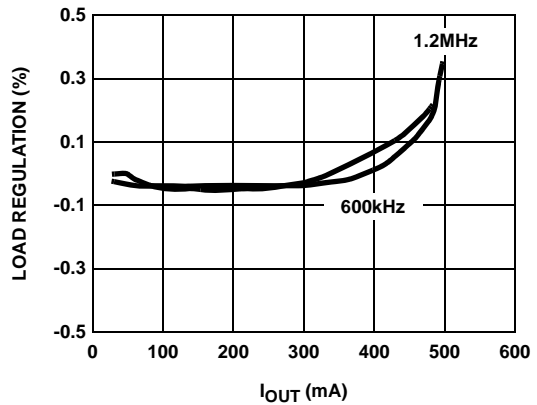

FIGURE 18. LOAD REGULATION - 3.3V TO 8V

Typical Performance Curves (Continued)

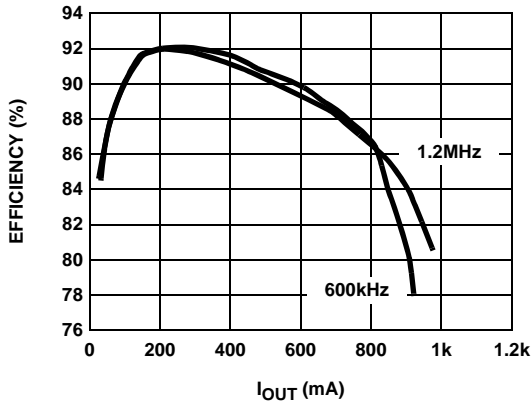

FIGURE 19. EFFICIENCY vs I<sub>OUT</sub>

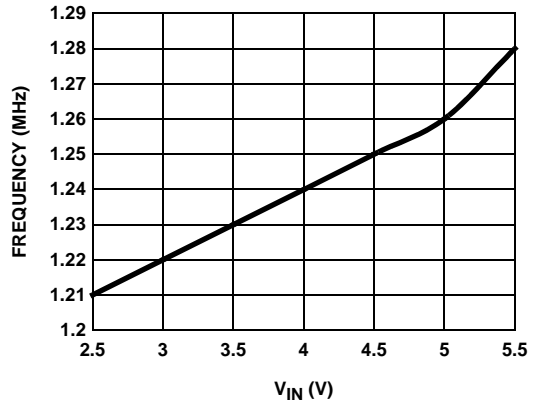

FIGURE 20. FREQUENCY (1.2MHz) vs V<sub>IN</sub>

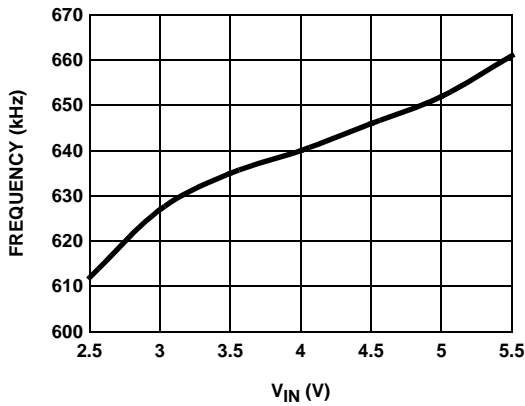

FIGURE 21. FREQUENCY (600kHz) vs V<sub>IN</sub>

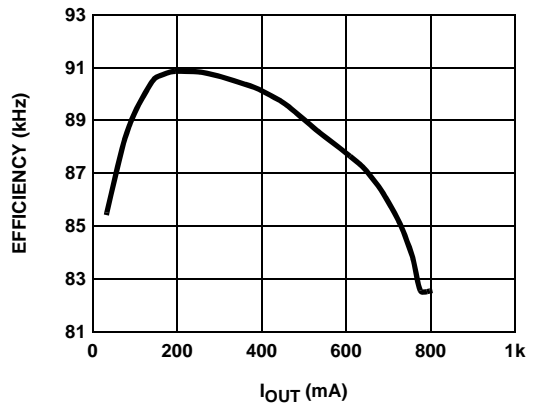

FIGURE 22. EFFICIENCY - 5V V<sub>IN</sub> TO 9V V<sub>OUT</sub> @ 600kHz

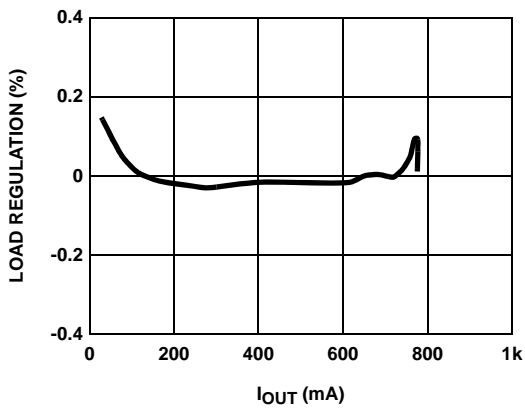

FIGURE 23. LOAD REGULATION - 5V V<sub>IN</sub> TO 9V V<sub>OUT</sub> @ 600kHz

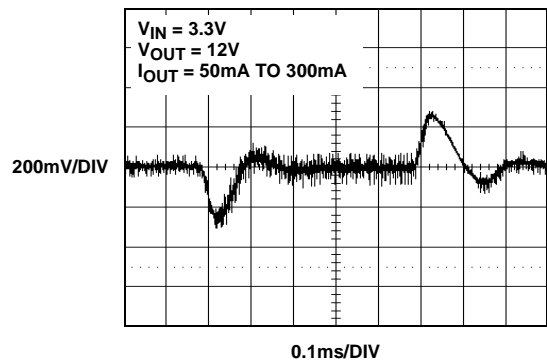

FIGURE 24. TRANSIENT REPOSE - 600kHz

Typical Performance Curves (Continued)

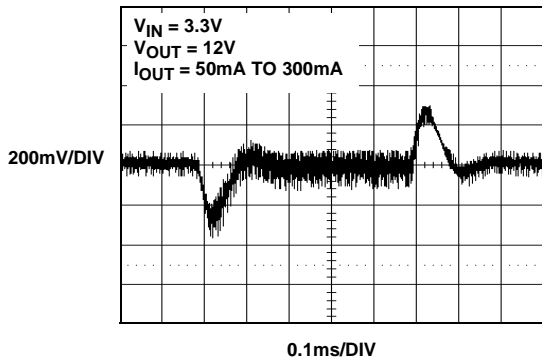

FIGURE 25. TRANSIENT RESPONSE - 1.2MHZ

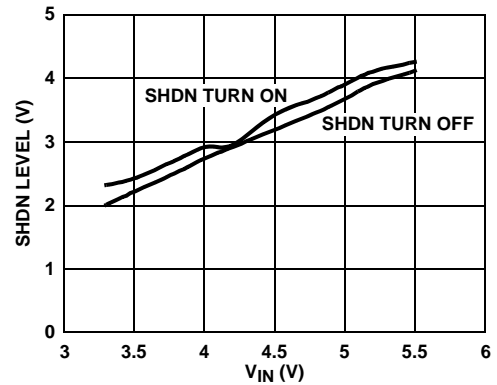

FIGURE 26. TYPICAL SHDN INPUT LEVEL vs  $V_{IN}$

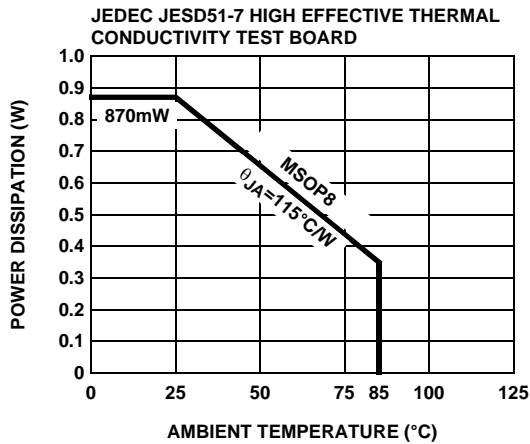

FIGURE 27. PACKAGE POWER DISSIPATION vs AMBIENT TEMPERATURE

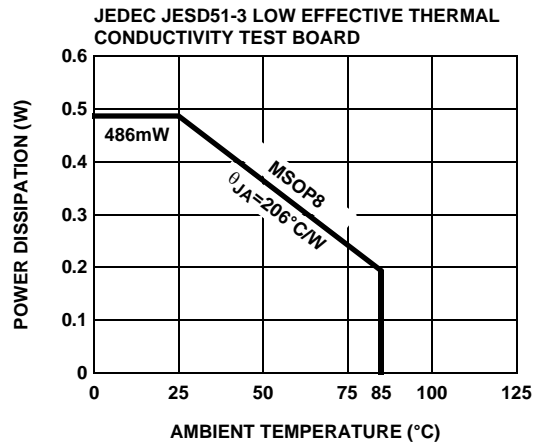

FIGURE 28. PACKAGE POWER DISSIPATION vs AMBIENT TEMPERATURE

Applications Information

The EL7516 is a high frequency, high efficiency boost regulator operated at constant frequency PWM mode. The boost converter stores energy from an input voltage source and delivers it to a higher output voltage. The input voltage range is 2.5V to 5.5V and the output voltage range is 5V to 18V. The switching frequency is selectable between 600KHz and 1.2MHz, allowing smaller inductors and faster transient response. An external compensation pin gives the user greater flexibility in setting output transient response and tighter load regulation. The converter soft-start characteristic can also be controlled by external  $C_{SS}$  capacitor. The SHDN pin allows the user to completely shut-down the device.

Boost Converter Operations

Figure 28 shows a boost converter with all the key components. In steady state operating and continuous conduction mode where the inductor current is continuous,

the boost converter operates in two cycles. During the first cycle, as shown in Figure 29, the internal power FET turns on and the Schottky diode is reverse biased and cuts off the current flow to the output. The output current is supplied from the output capacitor. The voltage across the inductor is  $V_{IN}$  and the inductor current ramps up in a rate of  $V_{IN} / L$ ,  $L$  is the inductance. The inductance is magnetized and energy is stored in the inductor. The change in inductor current is:

$$\Delta I_{L1} = \Delta t_1 \times \frac{V_{IN}}{L}$$

$$\Delta t_1 = \frac{D}{f_{SW}}$$

D = Duty Cycle

$$\Delta V_O = \frac{I_{OUT}}{C_{OUT}} \times \Delta t_1$$

(EQ. 1)



During the second cycle, the power FET turns off and the Schottky diode is forward biased, Figure 30. The energy stored in the inductor is pumped to the output supplying output current and charging the output capacitor. The Schottky diode side of the inductor is clamp to a Schottky diode above the output voltage, so the voltage drop across the inductor is  $V_{IN} - V_{OUT}$ . The change in inductor current during the second cycle is:

$$\Delta I_L = \Delta t_2 \times \frac{V_{IN} - V_{OUT}}{L}$$

$$\Delta t_2 = \frac{1-D}{f_{SW}} \tag{EQ. 2}$$

For stable operation, the same amount of energy stored in the inductor must be taken out. The change in inductor current during the two cycles must be the same.

$$\Delta I_1 + \Delta I_2 = 0$$

$$\frac{D}{f_{SW}} \times \frac{V_{IN}}{L} + \frac{1-D}{f_{SW}} \times \frac{V_{IN} - V_{OUT}}{L} = 0$$

$$\frac{V_{OUT}}{V_{IN}} = \frac{1}{1-D} \tag{EQ. 3}$$

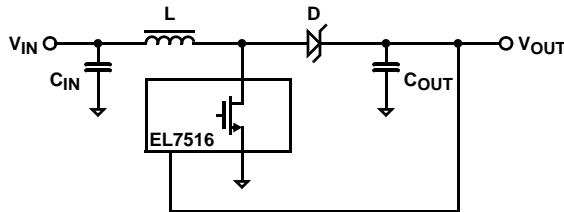

FIGURE 29. BOOST CONVERTER

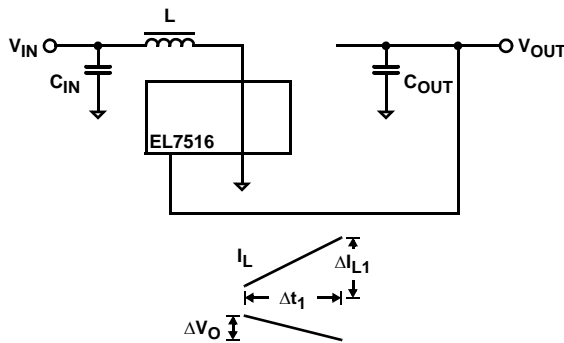

FIGURE 30. BOOST CONVERTER - CYCLE 1, POWER SWITCH CLOSED

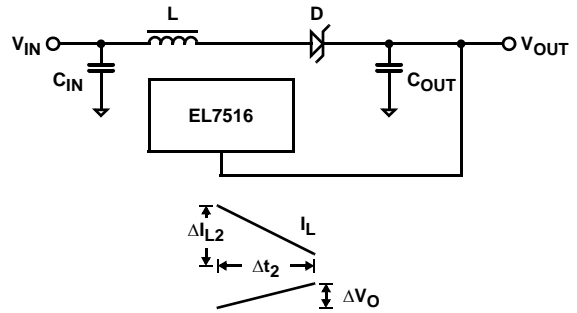

FIGURE 31. BOOST CONVERTER - CYCLE 2, POWER SWITCH OPEN

**Output Voltage**

An external feedback resistor divider is required to divide the output voltage down to the nominal 1.294V reference voltage. The current drawn by the resistor network should be limited to maintain the overall converter efficiency. The maximum value of the resistor network is limited by the feedback input bias current and the potential for noise being coupled into the feedback pin. A resistor network less than 100k is recommended. The boost converter output voltage is determined by the relationship:

$$V_{OUT} = V_{FB} \times \left( 1 + \frac{R_1}{R_2} \right) \tag{EQ. 4}$$

The nominal VFB voltage is 1.294V.

**Inductor Selection**

The inductor selection determines the output ripple voltage, transient response, output current capability, and efficiency. Its selection depends on the input voltage, output voltage, switching frequency, and maximum output current. For most applications, the inductance should be in the range of 2μH to 33μH. The inductor maximum DC current specification must be greater than the peak inductor current required by the regulator. The peak inductor current can be calculated:

$$I_{L(PEAK)} = \frac{I_{OUT} \times V_{OUT}}{V_{IN}} + 1/2 \times \frac{V_{IN} \times (V_{OUT} - V_{IN})}{L \times V_{OUT} \times \text{FREQ}} \tag{EQ. 5}$$

**Output Capacitor**

Low ESR capacitors should be used to minimize the output voltage ripple. Multilayer ceramic capacitors (X5R and X7R) are preferred for the output capacitors because of their lower ESR and small packages. Tantalum capacitors with higher ESR can also be used. The output ripple can be calculated as:

$$\Delta V_O = \frac{I_{OUT} \times D}{f_{SW} \times C_O} + I_{OUT} \times \text{ESR} \tag{EQ. 6}$$

For noise sensitive application, a 0.1μF placed in parallel with the larger output capacitor is recommended to reduce the switching noise coupled from the LX switching node.

**Schottky Diode**

In selecting the Schottky diode, the reverse break down voltage, forward current and forward voltage drop must be considered for optimum converter performance. The diode must be rated to handle 1.5A, the current limit of the EL7516. The breakdown voltage must exceed the maximum output voltage. Low forward voltage drop, low leakage current, and fast reverse recovery will help the converter to achieve the maximum efficiency.

**Input Capacitor**

The value of the input capacitor depends on the input and output voltages, the maximum output current, the inductor value and the noise allowed to put back on the input line. For most applications, a minimum 10µF is required. For applications that run close to the maximum output current limit, input capacitor in the range of 22µF to 47µF is recommended.

The EL7516 is powered from the  $V_{IN}$ . High frequency 0.1µF by-pass cap is recommended to be close to the  $V_{IN}$  pin to reduce supply line noise and ensure stable operation.

**Loop Compensation**

The EL7516 incorporates an transconductance amplifier in its feedback path to allow the user some adjustment on the transient response and better regulation. The EL7516 uses current mode control architecture, which has a fast current sense loop and a slow voltage feedback loop. The fast current feedback loop does not require any compensation. The slow voltage loop must be compensated for stable operation. The compensation network is a series RC network from COMP pin to ground. The resistor sets the high frequency integrator gain for fast transient response and the capacitor sets the integrator zero to ensure loop stability. For most applications, the compensation resistor in the range of 2k to 7.5k and the compensation capacitor in the range of 3nF to 10nF.

**Soft-Start**

The soft-start is provided by an internal 6µA current source, which charges the external  $C_{SS}$ . The peak MOSFET current is limited by the voltage on the capacitor. This in turn controls the rising rate of the output voltage. The regulator goes through the start-up sequence as well after the SHDN pin is pulled to HI.

**Frequency Selection**

The EL7516 switching frequency can be user selected to operate at either at constant 620kHz or 1.25MHz. Connecting  $F_{SEL}$  pin to ground sets the PWM switching frequency to 620kHz. When connect  $F_{SEL}$  high or  $V_{DD}$ , switching frequency is set to 1.25MHz.

**Shut-Down Control**

When the Shut-down pin is pulled down, the EL7516 is shut-down, reducing the supply current to <3µA.

EL7516 does not use a level translator or ground-referenced threshold for the SHDN input. For different supply voltages, please refer to Figure 32 to choose the right input threshold voltages for SHDN, where VTP is about 1V. It is recommended that  $V_{IH} = (V_{IN} - VTP/2)$  and  $V_{IL} = (V_{IN}/4)$ .

If the consistent SHDN threshold is desired in the application, an external active level shifter must be used. The simplest circuit requires 1 NMOS and 1 resistor, as shown in Figure 33 where the gate of the NMOS is connected to supply of PWRON logic circuit, and the source of the NMOS goes to PWRON pin of the converter.

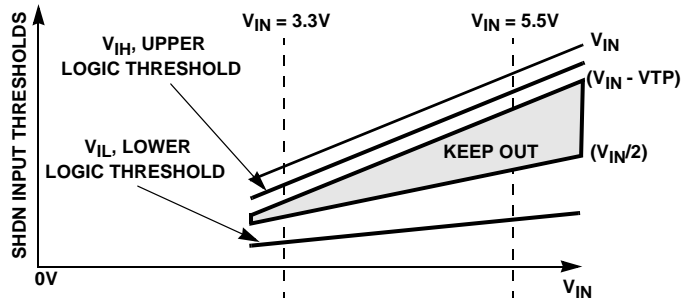

FIGURE 32. SHDN INPUT THRESHOLD vs INPUT SUPPLY VOLTAGE

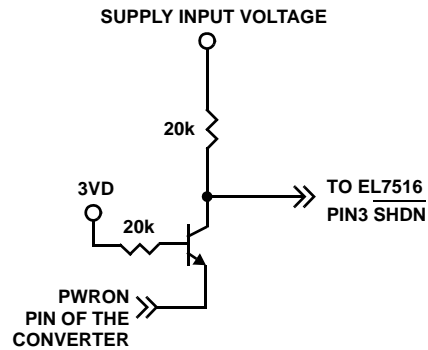

FIGURE 33. LEVEL SHIFTER CIRCUIT

**Maximum Output Current**

The MOSFET current limit is nominally 1.5A and guaranteed 1.3A. This restricts the maximum output current  $I_{OMAX}$  based on the following formula:

$$I_L = I_{L-AVG} + (1/2 \times \Delta I_L) \tag{EQ. 7}$$

where:

$I_L$  = MOSFET current limit

$I_{L-AVG}$  = average inductor current

$\Delta I_L$  = inductor ripple current

$$\Delta I_L = \frac{V_{IN} \times [(V_O + V_{DIODE}) - V_{IN}]}{L \times (V_O + V_{DIODE}) \times f_S} \quad (\text{EQ. 8})$$

$V_{DIODE}$  = Schottky diode forward voltage, typically, 0.6V

$f_S$  = switching frequency, 600kHz or 1.2MHz

$$I_{L-AVG} = \frac{I_{OUT}}{1-D} \quad (\text{EQ. 9})$$

D = MOSFET turn-on ratio:

$$D = 1 - \frac{V_{IN}}{V_{OUT} + V_{DIODE}} \quad (\text{EQ. 10})$$

Table 1 gives typical maximum  $I_{OUT}$  values for 1.2MHz switching frequency and 22μH inductor:

TABLE 1.

$V_{IN}$ (V)	$V_{OUT}$ (V)	$I_{OMAX}$ (mA)
2.5	5	570
2.5	9	325
2.5	12	250
3.3	5	750
3.3	9	435
3.3	12	330
5	9	650
5	12	490

**Thermal Performance**

The EL7516 uses a fused-lead package, which has a reduced  $\theta_{JA}$  of 100°C/W on a four-layer board and 115°C/W on a two-layer board. Maximizing copper around the ground pins will improve the thermal performance.

This device also has internal thermal shut-down set at around +130°C to protect the component.

**Layout Considerations**

To achieve highest efficiency, best regulation and the most stable operation, a good printed circuit board layout is essential. It is strongly recommended that the demoboard layout be followed as closely as possible. Use the following general guidelines when laying out the print circuit board:

1. Place  $C_4$  as close to the  $V_{DD}$  pin as possible.  $C_4$  is the supply bypass capacitor of the device.
2. Keep the  $C_1$  ground, GND pin and  $C_2$  ground as close as possible.
3. Keep the two high current paths a) from  $C_1$  through  $L_1$ , to the LX pin and GND and b) from  $C_1$  through  $L_1$ ,  $D_1$ , and  $C_2$  as short as possible.
4. High current traces should be as short and as wide as possible.
5. Place the feedback resistor close to the FB pin to avoid noise pickup.
6. Place the compensation network close to the COMP pin.

The demo board is a good example of layout based on these principles; it is available upon request.

**Differences Between EL7516 and ISL97516**

ISL97516 is the replacement for EL7516, and it is pin-to-pin compatible to EL7516, but there are differences between the two parts, as shown in the Table 2:

TABLE 2. DIFFERENCES BETWEEN EL7516 AND ISL97516

	ISL97516	EL7516
Current Limit	2.0A (typical value)	1.5A (typical value)
Over-Temperature Protection	+150°C	+130°C
Logic High or Low Level	Refer to Ground, Fixed.	Refer to input voltage, Varying

From Table 2, it shows that ISL97516 can provide more output current at the same conditions, and work in higher ambient temperature. The fixed logic level also helps reduce the system design complexity.

Mini SO Package Family (MSOP)

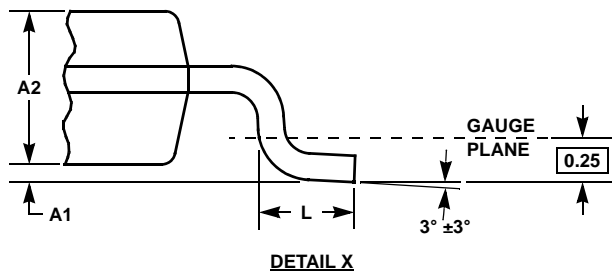
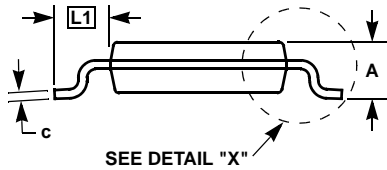
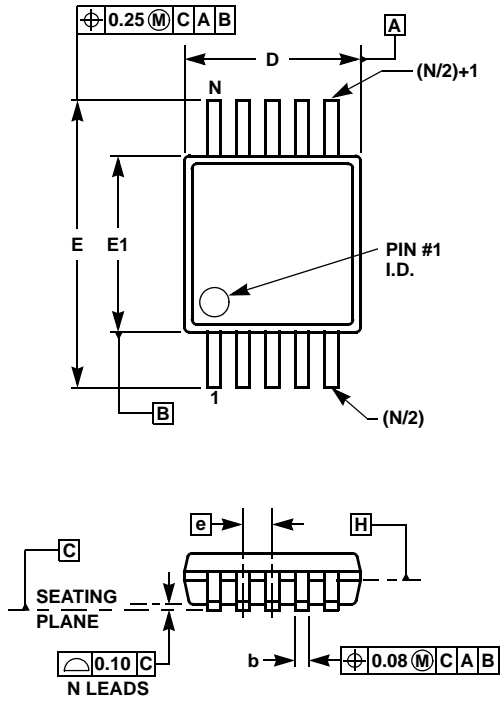

MDP0043  
MINI SO PACKAGE FAMILY

SYMBOL	MILLIMETERS		TOLERANCE	NOTES
	MSOP8	MSOP10		
A	1.10	1.10	Max.	-
A1	0.10	0.10	±0.05	-
A2	0.86	0.86	±0.09	-
b	0.33	0.23	+0.07/-0.08	-
c	0.18	0.18	±0.05	-
D	3.00	3.00	±0.10	1, 3
E	4.90	4.90	±0.15	-
E1	3.00	3.00	±0.10	2, 3
e	0.65	0.50	Basic	-
L	0.55	0.55	±0.15	-
L1	0.95	0.95	Basic	-
N	8	10	Reference	-

Rev. D 2/07

NOTES:

1. Plastic or metal protrusions of 0.15mm maximum per side are not included.
2. Plastic interlead protrusions of 0.25mm maximum per side are not included.
3. Dimensions "D" and "E1" are measured at Datum Plane "H".
4. Dimensioning and tolerancing per ASME Y14.5M-1994.

All Intersil U.S. products are manufactured, assembled and tested utilizing ISO9000 quality systems.  
Intersil Corporation's quality certifications can be viewed at [www.intersil.com/design/quality](http://www.intersil.com/design/quality)

Intersil products are sold by description only. Intersil Corporation reserves the right to make changes in circuit design, software and/or specifications at any time without notice. Accordingly, the reader is cautioned to verify that data sheets are current before placing orders. Information furnished by Intersil is believed to be accurate and reliable. However, no responsibility is assumed by Intersil or its subsidiaries for its use; nor for any infringements of patents or other rights of third parties which may result from its use. No license is granted by implication or otherwise under any patent or patent rights of Intersil or its subsidiaries.

For information regarding Intersil Corporation and its products, see [www.intersil.com](http://www.intersil.com)