

2ch.Step-Down DC/DC Controller ICs

GreenOperation Compatible

GENERAL DESCRIPTION

XC9503 series are PWM controlled, PWM/PFM automatic switching controlled, multi-functional, 2 channel step-down DC/DC controller ICs. Since the series has a built-in 0.9V reference voltage (accuracy $\pm 2\%$), 0.9V to 6.0V can be set using external components.

With a 300kHz frequency, the size of the external components can be reduced. Switching frequencies of 180kHz & 500kHz are also available as custom-designed products.

The control of the XC9503 series can be switched between PWM control and PWM/PFM automatic switching control using external signals. Control switches from PWM to PFM during light loads when automatic switching is selected and the series is highly efficient from light loads through to large output currents. Noise is easily reduced with PWM control since the frequency is fixed. The series gives freedom to select control suited to the application.

Soft-start time is internally set to 10msec and offers protection against in-rush currents when the power is switched on and also protects against voltage overshoot.

APPLICATIONS

- PDA's
- Palmtop computers
- Digital cameras
- Various multi function power supplies

FEATURES

- 2 ch DC/DC Controller (Step-Down & Down)**
- Input Voltage Range** : 2.0V ~ 10V
- Power Supply Voltage Range** : 2.0V ~ 10V
- Output Voltage Range** : 0.9V ~ 6.0V (set by FB pins)
- Oscillation Frequency** : 300kHz ($\pm 15\%$)
(180kHz, 500kHz custom)
- Maximum Duty Cycle** : 100%
- Control Method** : PWM or PWM/PFM Selectable
- Output Current** : More than 1000mA
($V_{IN}=5.0V$, $V_{OUT}=3.3V$)
- High Efficiency** : 92% (TPY.)
- Stand-By Function** : 3.0 μ A (MAX.)
- Soft-Start Time** : 10 ms (internally set)
- Packages** : MSOP-10, USP-10
- Environmentally Friendly** : EU RoHS Compliant, Pb Free

TYPICAL APPLICATION CIRCUIT

<XC9503B093A V_{OUT1} : 3.3V, V_{OUT2} : 1.8V >

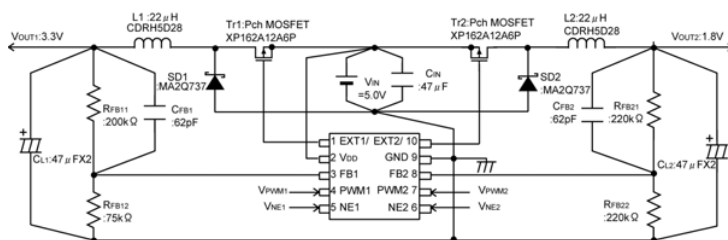

TYPICAL PERFORMANCE CHARACTERISTICS

Efficiency vs. Output Current

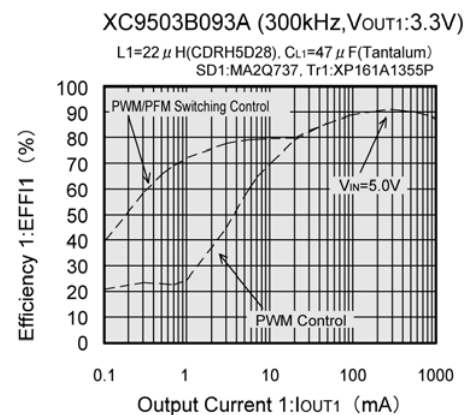

PIN CONFIGURATION

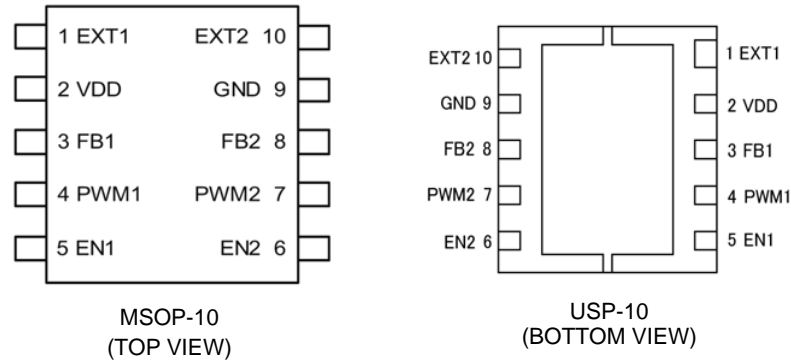

PIN ASSIGNMENT

PIN NUMBER	PIN NAME	FUNCTIONS
1	EXT 1	Channel 1: External Transistor Drive Pin <Connected to P-ch Power MOSFET Gate>
2	VDD	Supply Voltage
3	FB1	Channel 1: Output Voltage Monitor Feedback Pin <Threshold value: 0.9V. Output voltage can be set freely by connecting split resistors between VOUT1 and Ground.>
4	PWM1	Channel 1: PWM/PFM Switching Pin <Control Output 1. PWM control when connected to VDD, PWM / PFM auto switching when connected to Ground. >
5	EN1	Channel 1: Enable Pin <Connected to Ground when Output 1 is in stand-by mode. Connected to VDD when Output 1 is active. EXT1 is high when in stand-by mode.>
6	EN2	Channel 2: Enable Pin <Connected to Ground when Output 2 is in stand-by mode. Connected to VDD when Output 2 is active. EXT2/ is high when in stand-by mode.>
7	PWM2	Channel 2: PWM/PFM Switching Pin <Control Output 2. PWM control when connected to VDD, PWM / PFM auto switching when connected to Ground.>
8	FB2	Channel 2: Output Voltage Monitor Feedback Pin <Threshold value: 0.9V. Output voltage can be set freely by connecting split resistors between VOUT2 and Ground.>
9	GND	Ground
10	EXT2	Channel 2: External Transistor Drive Pin <Connected to P-ch Power MOSFET Gate>

PRODUCT CLASSIFICATION

Ordering Information

XC9503 - (*)

DESIGNATOR	ITEM	SYMBOL	DESCRIPTION
	Type of DC/DC Controller	B	Standard type (10 Pin)
	Output Voltage	09	FB products =0, =9 fixed
	Oscillation Frequency	2	180kHz (custom)
		3	300kHz
		5	500kHz (custom)
⑤⑥-⑦ (*)	Packages (Order Unit)	AR	MSOP-10 (1,000/Reel)
		AR-G	MSOP-10 (1,000/Reel)
		DR	USP-10 (3,000/Reel)
		DR-G	USP-10 (3,000/Reel)

(*) The "-G" suffix indicates that the products are Halogen and Antimony free as well as being fully RoHS compliant.

BLOCK DIAGRAM

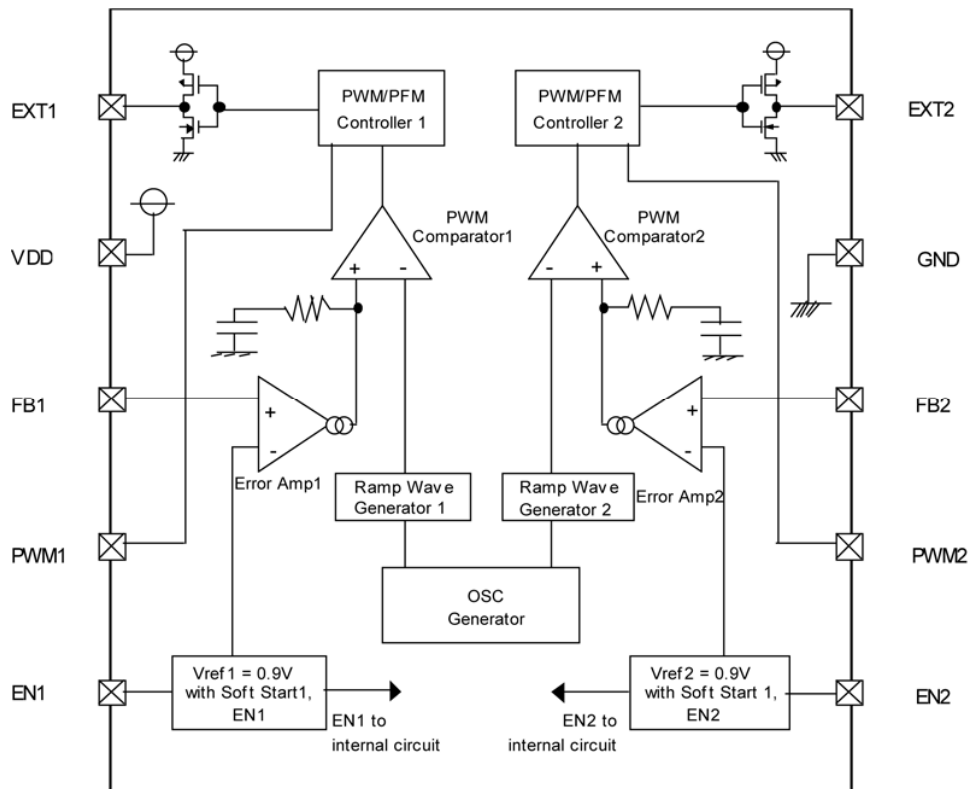

ABSOLUTE MAXIMUM RATINGS

Ta=25

PARAMETER	SYMBOL	RATINGS	UNITS
VDD Pin Voltage	VDD	- 0.3 ~ 12	V
FB1, 2 Pin Voltage	VFB	- 0.3 ~ 12	V
EN1, 2 Pin Voltage	VEN	- 0.3 ~ 12	V
PWM1, 2 Pin Voltage	VPWM	- 0.3 ~ 12	V
EXT1, 2 Pin Voltage	VEXT	- 0.3 ~ VDD + 0.3	V
EXT1, 2 Pin Current	IEXT	± 100	mA
Power Dissipation	MSOP-10	Pd	mW
	USP-10		
Operating Temperature Range	Topr	- 40 ~ + 85	
Storage Temperature Range	Tstg	- 55 ~ + 125	

Note: Voltage is all ground standardized.

ELECTRICAL CHARACTERISTICS

XC9503B092A

Common Characteristics

Ta=25

PARAMETER	SYMBOL	CONDITIONS	MIN.	TYP.	MAX.	UNITS	CIRCUIT
Supply Voltage	V _{DD}		2.0	-	10.0	V	
Maximum Input Voltage	V _{IN}		10.0	-	-	V	
Output Voltage Range (* 1)	V _{OUTSET}	V _{IN} 2.0V, I _{OUT1, 2} =1mA	V _{OUT1}	0.9	-	10.0	V
			V _{OUT2}	0.9	-	10.0	V
Supply Current 1	I _{DD1}	FB1, 2=0V	-	60	120	μA	
Supply Current 1-1	I _{DD1-1}	EN1=3.0V, EN2=0V, FB1=0V	-	50	110	μA	
		EN2=3.0V, EN1=0V, FB2=0V					
Supply Current 1-2	I _{DD1-2}	FB1=0V, FB2=1.0V	-	60	130	μA	
		FB1=1.0V, FB2=0V					
Supply Current 2	I _{DD2}	FB1, 2=1.0V	-	60	140	μA	
Stand-by Current	I _{STB}	Same as I _{DD1} , EN1=EN2=0V	-	1.0	3.0	μA	
Switching Frequency	F _{OSC}	Same as I _{DD1}	153	180	207	kHz	
EN1, 2 "High" Voltage	V _{ENH}	FB1, 2=0V	0.65	-	-	V	
EN1, 2 "Low" Voltage	V _{ENL}	FB1, 2=0V	-	-	0.20	V	
EN1, 2 "High" Current	I _{ENH}	EN1, 2=3.0V	-	-	0.50	μA	
EN1, 2 "Low" Current	I _{ENL}	EN1, 2=0V, FB1, 2=3.0V	-	-	-0.50	μA	
PWM1, 2 "High" Current	I _{PWMH}	FB1, 2=3.0V, PWM=3.0V	-	-	0.50	μA	
PWM1, 2 "Low" Current	I _{PWML}	FB1, 2=3.0V, PWM=0V	-	-	-0.50	μA	
FB1, 2 "High" Current	I _{FBH}	FB1, 2=3.0V	-	-	0.50	μA	
FB1, 2 "Low" Current	V _{FBL}	FB1, 2=1.0V	-	-	-0.50	μA	

Unless otherwise stated, V_{DD}=3.0V, PWM1, 2=3.0V, EN1, 2 =3.0V

Output 1 Characteristics

Step-Down Controller

PARAMETER	SYMBOL	CONDITIONS	MIN.	TYP.	MAX.	UNITS	CIRCUIT
FB1 Voltage	V _{FB1}	V _{IN} =3.0V, I _{OUT1} =10mA	0.882	0.900	0.918	V	
Minimum Operation Voltage	V _{INmin1}		-	-	2.0	V	①
Maximum Duty Ratio 1	MAXDTY1	Same as I _{DD1}	100	-	-	%	②
Minimum Duty Ratio 1	MINDTY1	Same as I _{DD2}	-	-	0	%	②
PFM Duty Ratio 1	PFMDTY1	No Load, V _{PWM1} =0V	22	30	38	%	④
Efficiency1 (* 4)	EFFI1	I _{OUT1} =250mA P-ch MOSFET: XP162A12A6P	-	92	-	%	④
Soft-Start Time1	T _{SS1}	V _{OUT1} × 0.95V, EN1=0V → 0.65V	5.0	10.0	20.0	ms	④
EXT1 "High" ON Resistance	R _{EXTBH1}	EN1=0, EXT1=V _{DD} -0.4V	-	28	47		⑤
EXT1 "Low" ON Resistance	R _{EXTBL1}	FB2=0V, EXT1=0.4V	-	22	30		⑤
PWM1 "High" Voltage	V _{PWMH1}	No Load	0.65	-	-	V	④
PWM1 "Low" Voltage	V _{PWML1}	No Load	-	-	0.20	V	④

Unless otherwise stated, V_{DD}=EN1=PWM1=3.0V, PWM2=EN2=GND, EXT2=OPEN, FB2=OPEN, V_{IN}=5.0V

Output 2 Characteristics

Step-Down Controller

PARAMETER	SYMBOL	CONDITIONS	MIN.	TYP.	MAX.	UNITS	CIRCUIT
FB2 Voltage	V _{FB2}	V _{IN} =3.0V, I _{OUT2} =10mA	0.882	0.900	0.918	V	⑥
Minimum Operating Voltage	V _{INmin2}		-	-	2.0	V	①
Maximum Duty Ratio 2	MAXDTY2	Same as I _{DD1}	100	-	-	%	②
Minimum Duty Ratio 2	MINDTY2	Same as I _{DD2}	-	-	0	%	②
PFM Duty Ratio 2	PFMDTY2	No Load, V _{PWM2} =0V	22	30	38	%	⑦
Efficiency 1 (* 2)	EFFI2	I _{OUT2} =250mA P-ch MOSFET: XP162A12A6P	-	92	-	%	⑦
Soft-Start Time 1	T _{SS2}	V _{OUT2} × 0.95V, EN2=0V → 0.65V	5.0	10.0	20.0	ms	⑦
EXT1 "High" ON Resistance	R _{EXTBH2}	EN2=0, EXT2=V _{DD} -0.4V	-	28	47		⑤
EXT1 "Low" ON Resistance	R _{EXTBL2}	FB2=0V, EXT2=0.4V	-	22	30		⑤
PWM 2 "High" Voltage	V _{PWMH2}	No Load	0.65	-	-	V	⑦
PWM 2 "Low" Voltage	V _{PWML2}	No Load	-	-	0.20	V	⑦

Unless otherwise stated, V_{DD}=EN2=PWM2=3.0V, PWM1=EN1=GND, EXT1=OPEN, FB1=OPEN, V_{IN}=5.0V

NOTE:

*1: Please be careful not to exceed the breakdown voltage level of the peripheral parts.

*2: EFFI={ [(output voltage) × (output current)] / [(input voltage) × (input current)] } × 100

ELECTRICAL CHARACTERISTICS (Continued)

XC9503B093A

Common Characteristics

Ta=25

PARAMETER	SYMBOL	CONDITIONS	MIN.	TYP.	MAX.	UNITS	CIRCUIT
Supply Voltage	V _{DD}		2.0	-	10.0	V	
Maximum Input Voltage	V _{IN}		10.0	-	-	V	
Output Voltage Range (* 1)	V _{OUTSET}	V _{IN} 2.0V, I _{OUT1,2} =1mA	$\frac{V_{OUT1}}{V_{OUT2}}$ 0.9	-	10.0	V	
Supply Current 1	I _{DD1}	FB1, 2=0V	-	70	140	μA	
Supply Current 1-1	I _{DD1-1}	EN1=3.0V, EN2=0V, FB1=0V EN2=3.0V, EN1=0V, FB2=0V	-	60	120	μA	
Supply Current 1-2	I _{DD1-2}	FB1=0V, FB2=1.0V FB1=1.0V, FB2=0V	-	70	150	μA	
Supply Current 2	I _{DD2}	FB1, 2=1.0V	-	80	150	μA	
Stand-by Current	I _{STB}	Same as I _{DD1} , EN1=EN2=0V	-	1.0	3.0	μA	
Switching Frequency	F _{OSC}	Same as I _{DD1}	255	300	345	kHz	
EN1, 2 "High" Voltage	V _{ENH}	FB1, 2=0V	0.65	-	-	V	
EN1, 2 "Low" Voltage	V _{ENL}	FB1, 2=0V	-	-	0.20	V	
EN1, 2 "High" Current	I _{ENH}	EN1, 2=3.0V	-	-	0.50	μA	
EN1, 2 "Low" Current	I _{ENL}	EN1, 2=0V, FB1, 2=3.0V	-	-	-0.50	μA	
PWM1, 2 "High" Current	I _{PWMH}	FB1, 2=3.0V, PWM=3.0V	-	-	0.50	μA	
PWM1, 2 "Low" Current	I _{PWML}	FB1, 2=3.0V, PWM=0V	-	-	-0.50	μA	
FB1, 2 "High" Current	I _{FBH}	FB1, 2=3.0V	-	-	0.50	μA	
FB1, 2 "Low" Current	I _{FBL}	FB1, 2=1.0V	-	-	-0.50	μA	

Unless otherwise stated, V_{DD}=3.0V, PWM1, 2=3.0V, EN1, 2 =3.0V

Output 1 Characteristics

Step-Down Controller

PARAMETER	SYMBOL	CONDITIONS	MIN.	TYP.	MAX.	UNITS	CIRCUIT
FB 1 Voltage	V _{FB1}	V _{IN} =3.0V I _{OUT1} =10mA	0.882	0.900	0.918	V	
Minimum Operating Voltage	V _{INmin1}		-	-	2.0	V	①
Maximum Duty Ratio 1	MAXDTY1	Same as I _{DD1}	100	-	-	%	②
Minimum Duty Ratio 1	MINDTY1	Same as I _{DD2}	-	-	0	%	②
PFM Duty Ratio 1	PFMDTY1	No Load, V _{PWM1} =0V	22	30	38	%	④
Efficiency1 (* 4)	EFF1	I _{OUT1} =250mA P-ch MOSFET: XP162A12A6P	-	92	-	%	④
Soft-Start Time 1	T _{SS1}	V _{OUT1} × 0.95V, EN1=0V → 0.65V	5.0	10.0	20.0	ms	④
EXT1 "High" ON Resistance	R _{EXTBH1}	EN1=0, EXT1=V _{DD} -0.4V	-	28	47		⑤
EXT1 "Low" ON Resistance	R _{EXTBL1}	FB2=0V, EXT1=0.4V	-	22	30		⑤
PWM1 "High" Voltage	V _{PWMH1}	No Load	0.65	-	-	V	④
PWM1 "Low" Voltage	V _{PWML1}	No Load	-	-	0.20	V	④

Unless otherwise stated, V_{DD}=EN1=PWM1=3.0V, PWM2=EN2=GND, EXT2=OPEN, FB2=OPEN, V_{IN}=5.0V

Output 2 Characteristics

Step-Down Controller

PARAMETER	SYMBOL	CONDITIONS	MIN.	TYP.	MAX.	UNITS	CIRCUIT
FB 2 Voltage	V _{FB2}	V _{IN} =3.0V, I _{OUT2} =10mA	0.882	0.900	0.918	V	⑥
Minimum Operating Voltage	V _{INmin2}		-	-	2.0	V	①
Maximum Duty Ratio 2	MAXDTY2	Same as I _{DD1}	100	-	-	%	②
Minimum Duty Ratio 2	MINDTY2	Same as I _{DD2}	-	-	0	%	②
PFM Duty Ratio 2	PFMDTY2	No Load, V _{PWM2} =0V	22	30	38	%	⑦
Efficiency 1 (* 2)	EFFI2	I _{OUT2} =250mA P-ch MOSFET: XP162A12A6P	-	92	-	%	⑦
Soft-Start Time 1	T _{SS2}	V _{OUT2} × 0.95V, EN2=0V → 0.65V	5.0	10.0	20.0	ms	⑦
EXT1 "High" ON Resistance	R _{EXTBH2}	EN2=0, EXT2=V _{DD} -0.4V	-	28	47		⑤
EXT1 "Low" ON Resistance	R _{EXTBL2}	FB2=0V, EXT2=0.4V	-	22	30		⑤
PWM2 "High" Voltage	V _{PWMH2}	No Load	0.65	-	-	V	⑦
PWM2 "Low" Voltage	V _{PWML2}	No Load	-	-	0.20	V	⑦

Unless otherwise stated, V_{DD}=EN2=PWM2=3.0V, PWM1=EN1=GND, EXT1=OPEN, FB1=OPEN, V_{IN}=5.0V

NOTE:

*1: Please be careful not to exceed the breakdown voltage level of the peripheral parts.

*2: $EFFI = \left\{ \frac{(\text{output voltage}) \times (\text{output current})}{(\text{input voltage}) \times (\text{input current})} \right\} \times 100$

ELECTRICAL CHARACTERISTICS (Continued)

XC9503B095A Common Characteristics

Ta=25

PARAMETER	SYMBOL	CONDITIONS	MIN.	TYP.	MAX.	UNITS	CIRCUIT	
Supply Voltage	V _{DD}		2.0	-	10.0	V		
Maximum Input Voltage	V _{IN}		10.0	-	-	V		
Output Voltage Range (* 1)	V _{OUTSET}	V _{IN} 2.0V, I _{OUT1,2} =1mA	$\frac{V_{OUT1}}{V_{OUT2}}$	0.9	-	10.0	V	
				0.9	-	10.0	V	
Supply Current 1	I _{DD1}	FB1, 2=0V	-	90	170	μA		
Supply Current 1-1	I _{DD1-1}	EN1=3.0V, EN2=0V, FB1=0V	-	80	150	μA		
		EN2=3.0V, EN1=0V, FB2=0V						
Supply Current 1-2	I _{DD1-2}	FB1=0V, FB2=1.0V	-	100	180	μA		
		FB1=1.0V, FB2=0V						
Supply Current 2	I _{DD2}	FB1, 2=1.0V	-	100	190	μA		
Stand-by Current	I _{STB}	Same as I _{DD1} , EN1=EN2=0V	-	1.0	3.0	μA		
Switching Frequency	F _{OSC}	Same as I _{DD1}	425	500	575	kHz		
EN1, 2 "High" Voltage	V _{ENH}	FB1, 2=0V	0.65	-	-	V		
EN1, 2 "Low" Voltage	V _{ENL}	FB1, 2=0V	-	-	0.20	V		
EN1, 2 "High" Current	I _{ENH}	EN1, 2=3.0V	-	-	0.50	μA		
EN1, 2 "Low" Current	I _{ENL}	EN1, 2=0V, FB1, 2=3.0V	-	-	-0.50	μA		
PWM1, 2 "High" Current	I _{PWMH}	FB1, 2=3.0V, PWM=3.0V	-	-	0.50	μA		
PWM1, 2 "Low" Current	I _{PWML}	FB1, 2=3.0V, PWM=0V	-	-	-0.50	μA		
FB1, 2 "High" Current	I _{FBH}	FB1, 2=3.0V	-	-	0.50	μA		
FB1, 2 "Low" Current	V _{FBL}	FB1, 2=1.0V	-	-	-0.50	μA		

Unless otherwise stated, V_{DD}=3.0V, PWM1, 2=3.0V, EN1, 2 =3.0V

Output 1 Characteristics Step-Down Controller

PARAMETER	SYMBOL	CONDITIONS	MIN.	TYP.	MAX.	UNITS	CIRCUIT
FB 1 Voltage	V _{FB1}	V _{IN} =3.0V, I _{OUT1} =10mA	0.882	0.900	0.918	V	
Minimum Operation Voltage	V _{INmin1}		-	-	2.0	V	①
Maximum Duty Ratio 1	MAXDTY1	Same as I _{DD1}	100	-	-	%	②
Minimum Duty Ratio 1	MINDTY1	Same as I _{DD2}	-	-	0	%	②
PFM Duty Ratio 1	PFMDTY1	No Load, V _{PWM1} =0V	22	30	38	%	④
Efficiency1 (* 4)	EFF11	I _{OUT1} =250mA P-ch MOSFET: XP162A12A6P	-	91	-	%	④
Soft-Start Time 1	T _{SS1}	V _{OUT1} × 0.95V, EN1=0V → 0.65V	5.0	10.0	20.0	ms	④
EXT1 "High" ON Resistance	R _{EXTBH1}	EN1=0, EXT1=V _{DD} -0.4V	-	28	47	Ω	⑤
EXT1 "Low" ON Resistance	R _{EXTBL1}	FB2=0V, EXT1=0.4V	-	22	30	Ω	⑤
PWM1 "High" Voltage	V _{PWMH1}	No Load	0.65	-	-	V	④
PWM1 "Low" Voltage	V _{PWML1}	No Load	-	-	0.20	V	④

Unless otherwise stated, V_{DD}=EN1=PWM1=3.0V, PWM2=EN2=GND, EXT2=OPEN, FB2=OPEN, V_{IN}=5.0V

Output 2 Characteristics Step-Down Controller

PARAMETER	SYMBOL	CONDITIONS	MIN.	TYP.	MAX.	UNITS	CIRCUIT
FB 2 Voltage	V _{FB2}	V _{IN} =3.0V, I _{OUT2} =10mA	0.882	0.900	0.918	V	⑥
Minimum Operation Voltage	V _{INmin2}		-	-	2.0	V	①
Maximum Duty Ratio 2	MAXDTY2	Same as I _{DD1}	100	-	-	%	②
Minimum Duty Ratio 2	MINDTY2	Same as I _{DD2}	-	-	0	%	②
PFM Duty Ratio 2	PFMDTY2	No Load, V _{PWM2} =0V	22	30	38	%	⑦
Efficiency 1 (* 2)	EFF12	I _{OUT2} =250mA P-ch MOSFET: XP162A12A6P	-	91	-	%	⑦
Soft-Start Time 1	T _{SS2}	V _{OUT2} × 0.95V, EN2=0V → 0.65V	5.0	10.0	20.0	ms	⑦
EXT1 "High" ON Resistance	R _{EXTBH2}	EN2=0, EXT2=V _{DD} -0.4V	-	28	47	Ω	⑤
EXT1 "Low" ON Resistance	R _{EXTBL2}	FB2=0V, EXT2=0.4V	-	22	30	Ω	⑤
PWM2 "High" Voltage	V _{PWMH2}	No Load	0.65	-	-	V	⑦
PWM2 "Low" Voltage	V _{PWML2}	No Load	-	-	0.20	V	⑦

Unless otherwise stated, V_{DD}=EN2=PWM2=3.0V, PWM1=EN1=GND, EXT1=OPEN, FB1=OPEN, V_{IN}=5.0V

NOTE:

*1 : Please be careful not to exceed the breakdown voltage level of the peripheral parts.

*2 : $EFF1 = \left\{ \left[\frac{\text{output voltage}}{\text{input voltage}} \right] \times \left[\frac{\text{output current}}{\text{input current}} \right] \right\} \times 100$

OPERATIONAL EXPLANATION

The XC9503 series are multi-functional, 2 channel step-down DC/DC converter controller ICs with built-in high speed, low ON resistance drivers.

<Error Amp. 1, 2>

The Error Amplifier is designed to monitor the output voltage and it compares the feedback voltage (FB) with the reference voltage. In response to feedback of a voltage lower than the reference voltage, the output voltage of the error amp. decreases.

<OSC Generator>

This circuit generates the switching frequency, which in turn generates the reference clock.

<Ramp Wave Generator 1, 2>

The ramp wave generator generates a saw-tooth waveform based on outputs from the phase shift generator.

<PWM Comparator 1, 2>

The PWM comparator compares outputs from the error amp. and saw-tooth waveform. When the voltage from the error amp's output is low, the external switch will be set to ON.

<PWM/PFM Controller 1, 2>

This circuit generates PFM pulses.

Control can be switched between PWM control and PWM/PFM automatic switching control using external signals.

The PWM/PFM automatic switching mode is selected when the voltage of the PWM1 (2) pin is less than 0.2V, and the control switches between PWM and PFM automatically depending on the load. As the PFM circuit generates pulses based on outputs from the PWM comparator, shifting between modes occurs smoothly. PWM control mode is selected when the voltage of the PWM1 (2) pin is more than 0.65V. Noise is easily reduced with PWM control since the switching frequency is fixed.

Control suited to the application can easily be selected which is useful in audio applications, for example, where traditionally, efficiencies have been sacrificed during stand-by as a result of using PWM control (due to the noise problems associated with the PFM mode in stand-by).

<Vref with Soft Start 1, 2>

The reference voltage, Vref (FB pin voltage)=0.9V, is adjusted and fixed by laser trimming (for output voltage settings, please refer to next page). To protect against inrush current, when the power is switched on, and also to protect against voltage overshoot, soft-start time is set internally to 10ms. It should be noted, however, that this circuit does not protect the load capacitor (CL) from inrush current. With the Vref voltage limited and depending upon the input to the error amps, the operation maintains a balance between the two inputs of the error amps and controls the EXT pin's ON time so that it doesn't increase more than is necessary.

<Chip Enable Function>

This function controls the operation and shutdown of the IC. When the voltage of the EN1 or EN2 pins is 0.2V or less, the mode will be chip disable, the channel's operations will stop and the EXT pins will be kept at a high level (the external P-ch MOSFET will be OFF). When both EN1 and EN2 are in a state of chip disable, current consumption will be no more than 3.0 μ A. When the EN1 or EN2 pin's voltage is 0.65V or more, the mode will be chip enable and operations will recommence. With soft-start, 95% of the set output voltage will be reached within 10mS (TYP.) from the moment of chip enable.

OPERATIONAL EXPLANATION (Continued)

<Setting of Output Voltage>

Output voltage can be set by adding external split resistors. Output voltage is determined by the following equation, based on the values of RFB11 (RFB21) and RFB12 (RFB22). The sum of RFB11 (RFB21) and RFB12 (RFB22) should normally be 1M or less.

$$V_{OUT} = 0.9 \times (R_{FB11} + R_{FB12}) / R_{FB12}$$

The value of CFB1 (CFB2), speed-up capacitor for phase compensation, should be $f_{zfb} = 1 / (2 \times C_{FB1} \times R_{FB11})$ which is equal to 12kHz. Adjustments are required from 1kHz to 50kHz depending on the application, value of inductance (L), and value of load capacity (CL).

[Example of Calculation]

When $R_{FB11} = 200k$ and $R_{FB12} = 75k$, $V_{OUT1} = 0.9 \times (200k + 75k) / 75k = 3.3V$.

[Typical Example]

V _{OUT} (V)	R _{FB11} (kΩ)	R _{FB12} (kΩ)	C _{FB1} (pF)	V _{OUT} (V)	R _{FB11} (kΩ)	R _{FB12} (kΩ)	C _{FB1} (pF)
1.0	30	270	430	2.5	390	220	33
1.5	220	330	62	2.7	360	180	33
1.8	220	220	62	3.0	560	240	24
2.0	330	270	39	3.3	200	75	62
2.2	390	270	33	5.0	82	18	160

The same method can be adopted for channel two also.

[External Components]

Tr : * MOSFET

XP162A12A6P (P-ch Power MOSFET, TOREX)

Note: V_{GS} breakdown voltage of this Tr. is 12V so please be careful with the power supply voltage.

SD : MA2Q737 (Schottky, MATSUSHITA)

CMS02 (Schottky, TOSHIBA)

L : 10 μH (CDRH5D28, SUMIDA, FOSC = 500kHz)

22 μH (CDRH5D28, SUMIDA, FOSC = 300kHz)

22 μH (CDRH5D28, SUMIDA, FOSC = 180kHz)

CL1 : 16V, 47 μF (Tantalum)

Increase capacity according to the equation below when the step-up voltage ratio is large and output current is high.

$$C = (CL \text{ standard value}) \times (I_{OUT} (mA) / 500mA \times V_{OUT} / V_{IN})$$

Tr : * PNP MOSFET

2SA1213 (SANYO)

R_B : 500 (Adjust in accordance with load & Tr.'s HFE.)

Set according to the equation below.

$$R_B = (V_{IN} - 0.7) \times h_{FE} / I_C - R_{EXTBH}$$

C_B : 2200pF (Ceramic)

Set according to the equation below.

$$C_B = (2 \times R_B \times FOSC \times 0.7)$$

The same components can be adopted for both channel 1 and channel 2.

TEST CIRCUITS

Circuit

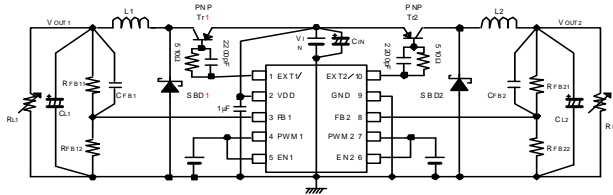

Circuit

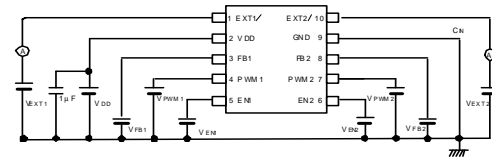

Circuit

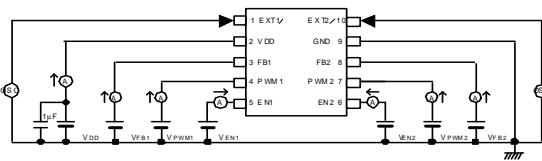

Circuit

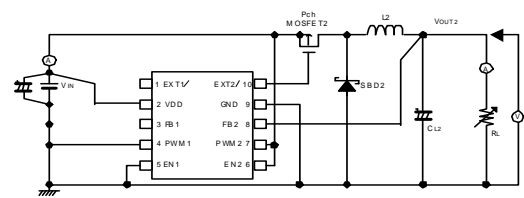

Circuit

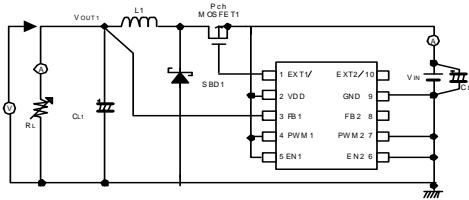

Circuit

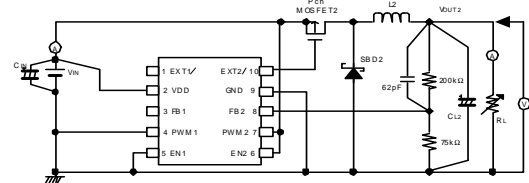

Circuit

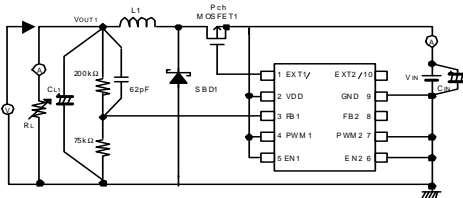

EXTERNAL COMPONENTS USED FOR TEST CIRCUITS

Circuit	L1, L2:	22 μ H (CDRH5D28, SUMIDA)	: XC9503B092A
		15 μ H (CDRH5D28, SUMIDA)	: XC9503B093A
		10 μ H (CDRH5D28, SUMIDA)	: XC9503B095A
	SD1, SD2:	CRS02 (Schottky diode, TOSHIBA)	
		EC10QS06 (Schottky diode, NIHON INTER)	
	CL1, CL2:	16MCE476MD2 (Tantalum, NIHON CHEMICON)	
	CIN:	16MCE476MD2 (Tantalum, NIHON CHEMICON)	
	PNP Tr1:	2SA1213 (TOSHIBA)	
	RFB:	Please use by the conditions as below: $RFB11 + RFB12 \leq 1M$ $RFB21 + RFB22 \leq 1M$ $RFB11 / RFB12 = (\text{Setting output voltage} / 0.9) - 1$ $VOUT2 = (0.9 - VOUT1) \times (RFB21/RFB22) + 0.9V$	
	CFB:	Please adjust as below: $f_{x\text{fb}} = 1 / (2 \times \pi \times CFB1 \times RFB11) = 1\text{kHz} \sim 50\text{kHz} (12\text{kHz usual})$ $f_{x\text{fb}} = 1 / (2 \times \pi \times CFB2 \times RFB21) = 1\text{kHz} \sim 50\text{kHz} (12\text{kHz usual})$	
Circuit	L1:	22 μ H (CDRH5D28, SUMIDA)	
	SD1:	MA2Q737 (Schottky diode, MATSUSHITA)	
	CL1:	16MCE476MD2 (Tantalum, NIHON CHEMICON)	
	CIN:	16MCE476MD2 (Tantalum, NIHON CHEMICON)	
	P-ch MOSFET1:	XP162A12A6P (TOREX)	
Circuit	L1:	22 μ H (CDRH5D28, SUMIDA)	: XC9503B092A
		15 μ H (CDRH5D28, SUMIDA)	: XC9503B093A
		10 μ H (CDRH5D28, SUMIDA)	: XC9503B095A
	SD1:	MA2Q737 (Schottky diode, MATSUSHITA)	
	CL1:	16MCE476MD2 (Tantalum, NIHON CHEMICON)	
	CIN:	16MCE476MD2 (Tantalum, NIHON CHEMICON)	
	P-ch MOSFET1:	XP162A12A6P (TOREX)	
Circuit	L1:	22 μ H (CDRH5D28, SUMIDA)	
	SD1:	MA2Q737 (Schottky diode, MATSUSHITA)	
	CL1:	16MCE476MD2 (Tantalum, NIHON CHEMICON)	
	CIN:	16MCE476MD2 (Tantalum, NIHON CHEMICON)	
	P-ch MOSFET2:	XP162A12A6P (TOREX)	
Circuit	L2:	22 μ H (CDRH5D28, SUMIDA)	: XC9503B092A
		15 μ H (CDRH5D28, SUMIDA)	: XC9503B093A
		10 μ H (CDRH5D28, SUMIDA)	: XC9503B095A
	SD2:	MA2Q737 (Schottky diode, MATSUSHITA)	
	CL2:	16MCE476MD2 (Tantalum, NIHON CHEMICON)	
	CIN:	16MCE476MD2 (Tantalum, NIHON CHEMICON)	
	P-ch MOSFET2:	XP162A12A6P (TOREX)	

NOTES ON USE

1. Checking for Intermittent Oscillation

The XC9503 series is subject to intermittent oscillation in the proximity of the maximum duty if the step-down ratio is low (e.g., from 4.2 V to 3.3 V) or a heavy load is applied where the duty ratio becomes high. Check waveforms at EXT under your operating conditions. A remedy for this problem is to raise the inductance of coil L or increase the load capacitance CL.

2. PWM/PFM Automatic Switching

If PWM/PFM automatic switching control is selected and the step-down ratio is low (e.g, from 4.5V to 5.0V) or high (e.g., from 10 V to 1.0 V), the control mode remains in PFM setting over the whole load range, since the duty ratio under continuous-duty condition is smaller than the PFM duty ratio of the XC9503 series. The output voltage's ripple voltage becomes substantially high under heavy load conditions, with the XC9503 series appearing to be producing an abnormal oscillation. If this operation becomes a concern, set pins PWM1 and PWM2 to High to set the control mode to PWM setting. For use under the above-mentioned condition, measured data of PWM/PFM automatic switching control shown on the data sheets are available up to IOUT = 100 mA.

3. Ratings

Use the XC9503 series and external components within the limits of their ratings.

TYPICAL PERFORMANCE CHARACTERISTICS

(1) Output Voltage vs. Output Current

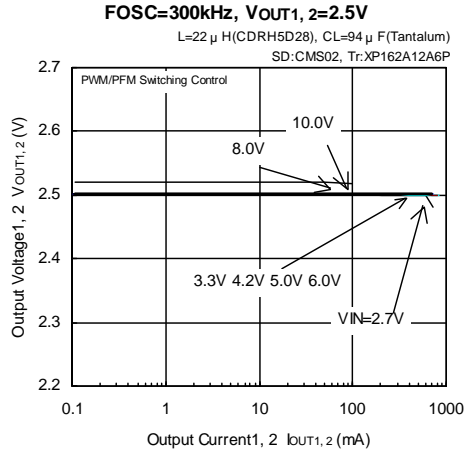
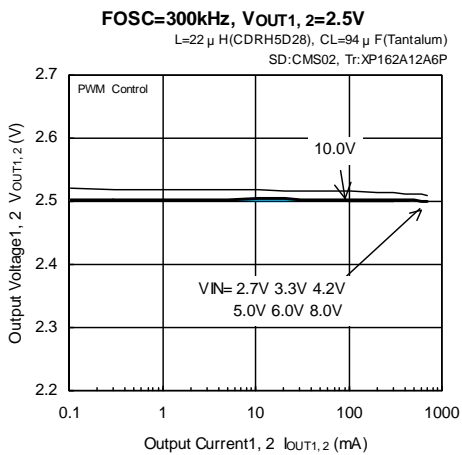
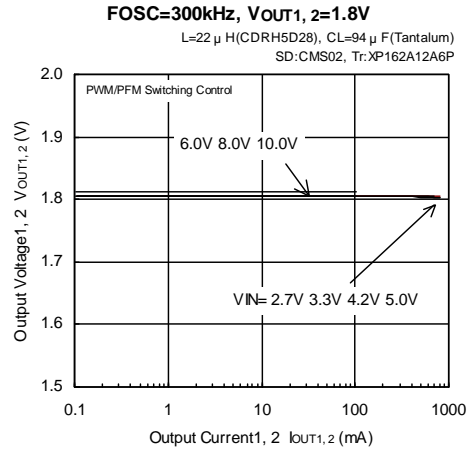
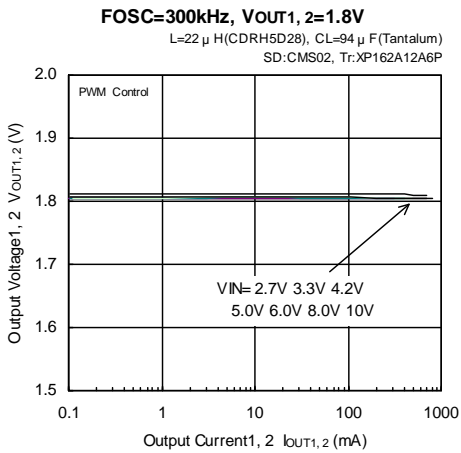
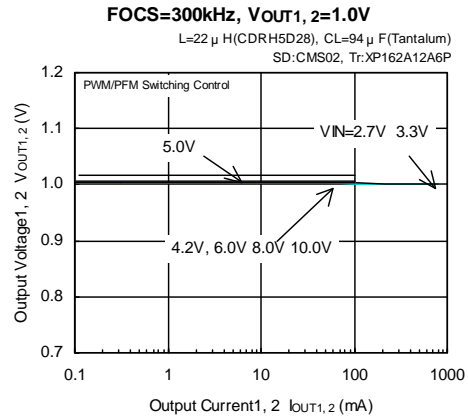
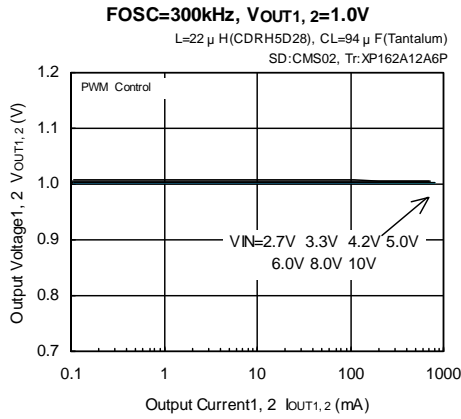

* When setting V_{OUT1,2}=1.0V, V_{IN}=8.0V, 10.0V,
 CL should be 94 μ F (Tantalum) + 100 μ F (OS-COM)

TYPICAL PERFORMANCE CHARACTERISTICS (Continued)

(1) Output Voltage vs. Output Current (Continued)

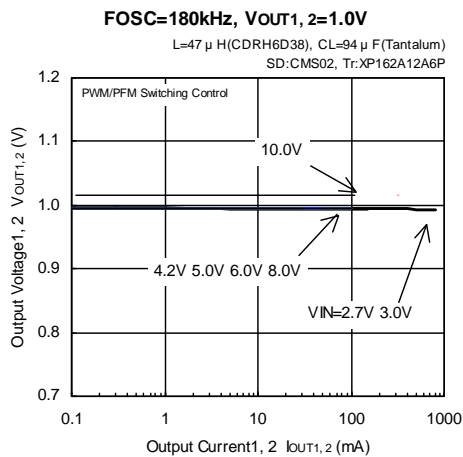
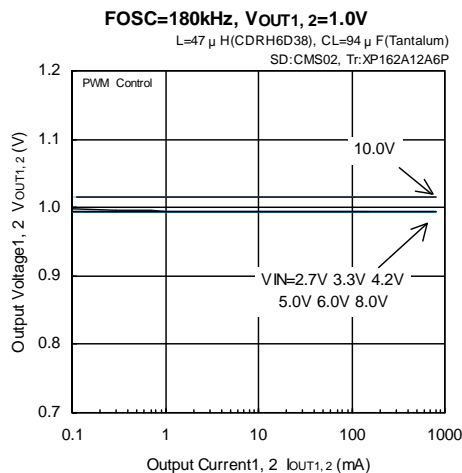
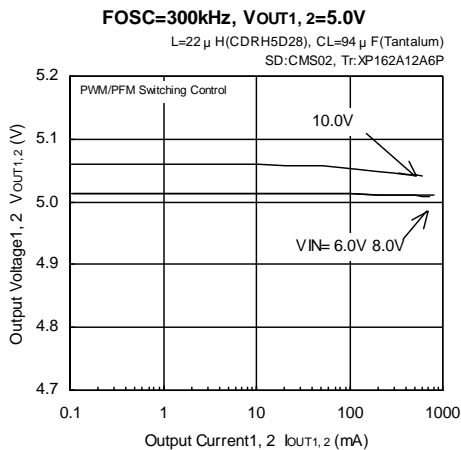
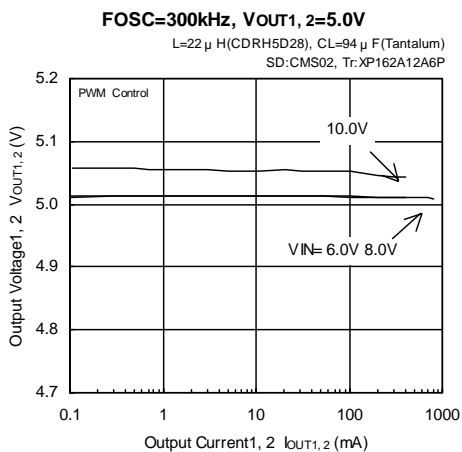
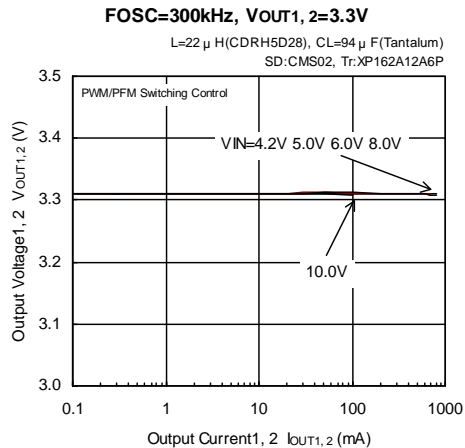
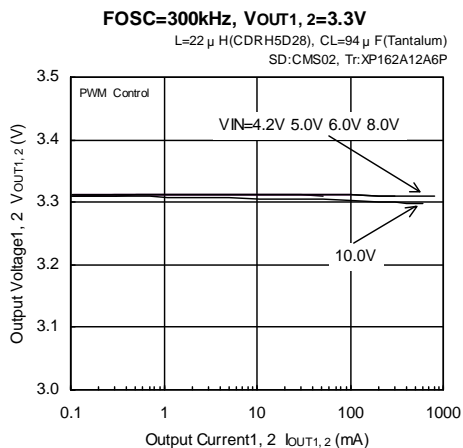

* When setting V_{OUT1,2}=1.0V, V_{IN}=8.0V, 10.0V,
 CL should be 94 μ F (Tantalum) + 100 μ F (OS-COM)

TYPICAL PERFORMANCE CHARACTERISTICS (Continued)

(1) Output Voltage vs. Output Current (Continued)

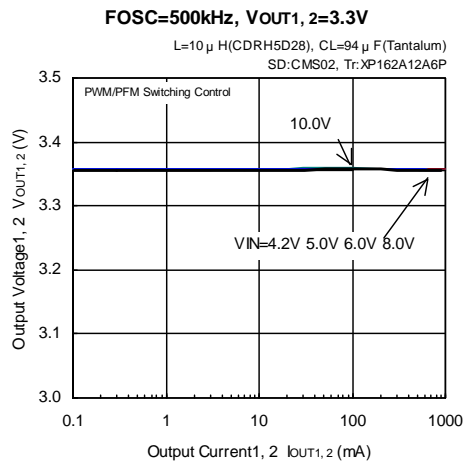
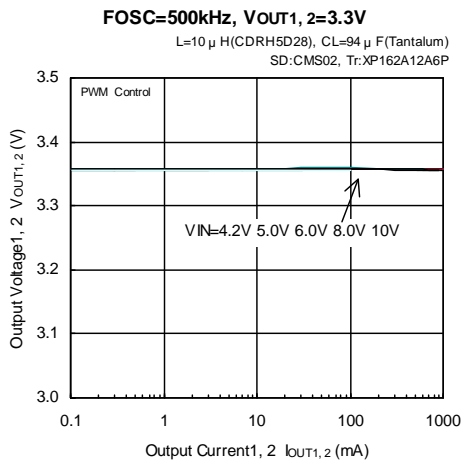
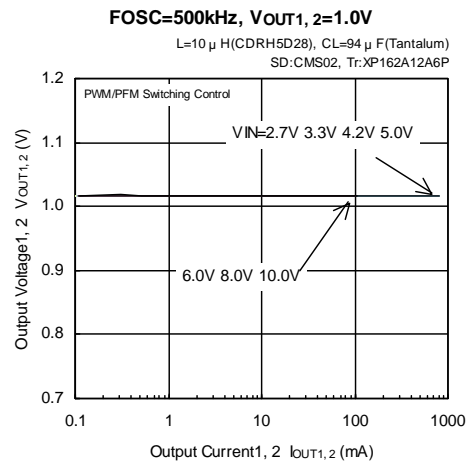
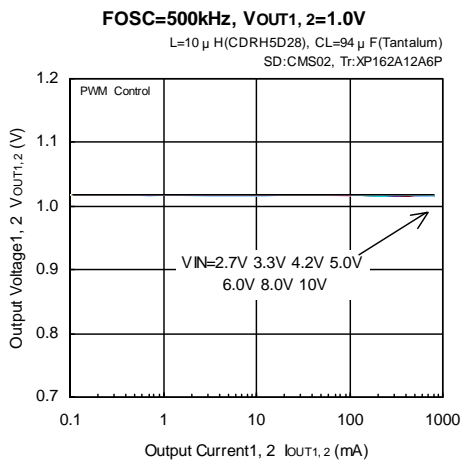
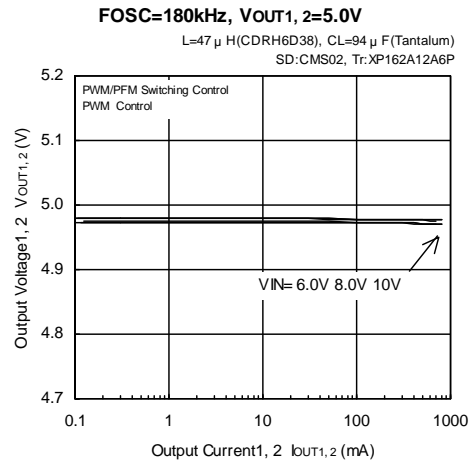
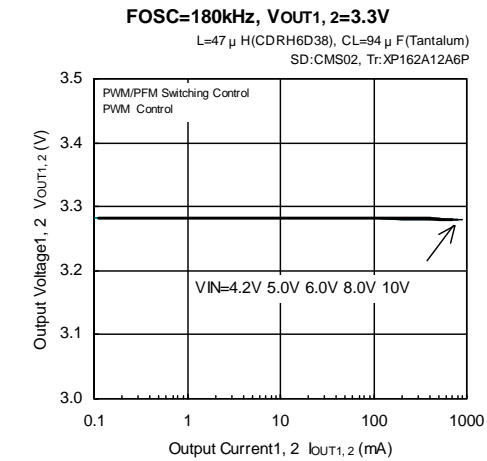

* When setting VOUT1,2=1.0V, VIN=8.0V, 10.0V,
 CL should be 94 μ F (Tantalum) + 100 μ F (OS-COM)

TYPICAL PERFORMANCE CHARACTERISTICS (Continued)

(1) Output Voltage vs. Output Current (Continued)

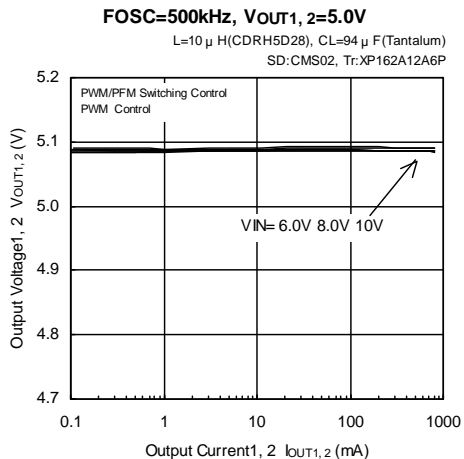

TYPICAL PERFORMANCE CHARACTERISTICS (Continued)

(2) Efficiency vs. Output Current

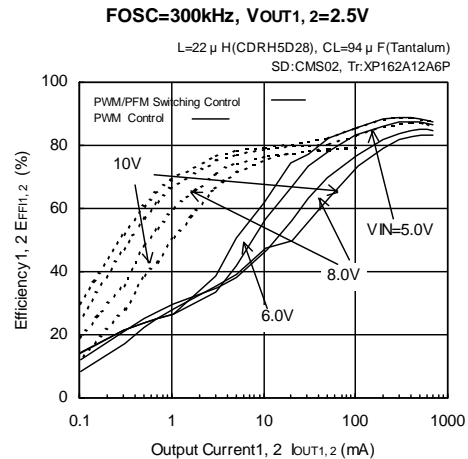
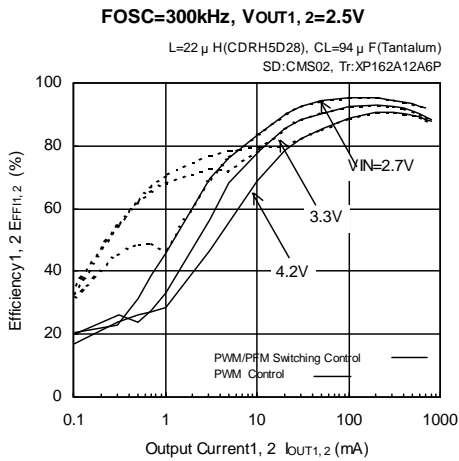
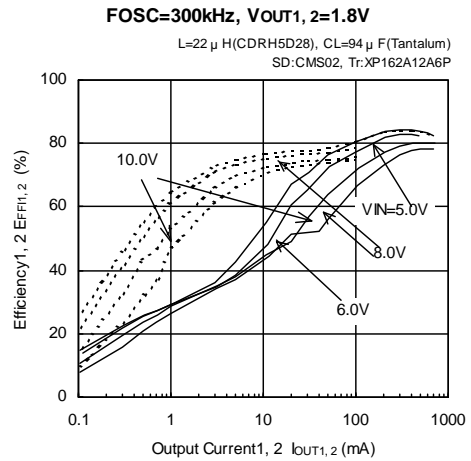
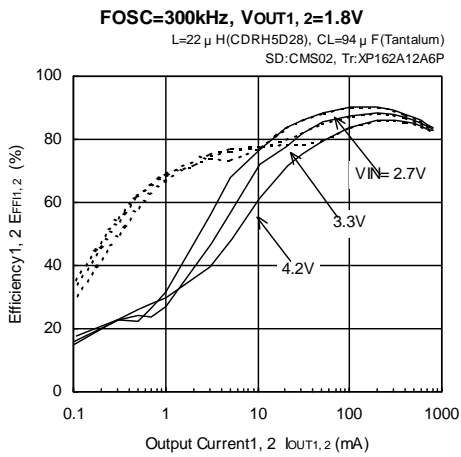
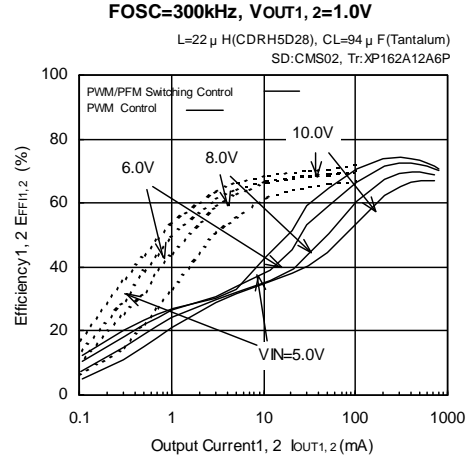
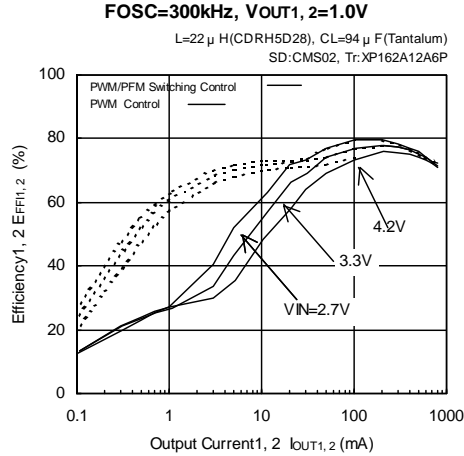

* When setting VOUT1, 2=1.0V, VIN=8.0V, 10.0V,
 CL should be 94 μ F (Tantalum) + 100 μ F (OS-COM)

TYPICAL PERFORMANCE CHARACTERISTICS (Continued)

(2) Efficiency vs. Output Current (Continued)

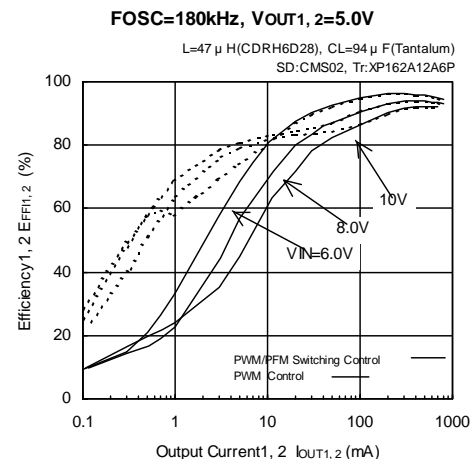
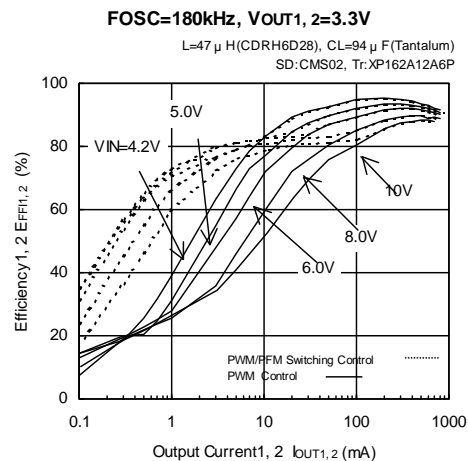
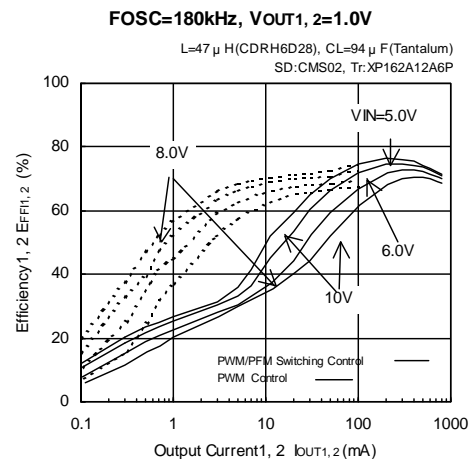
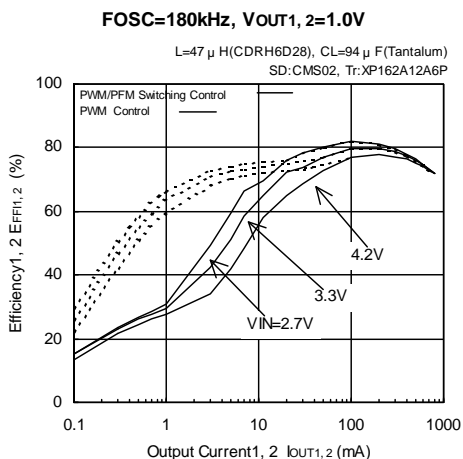
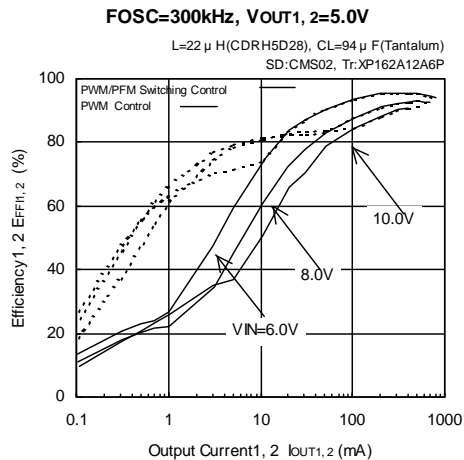
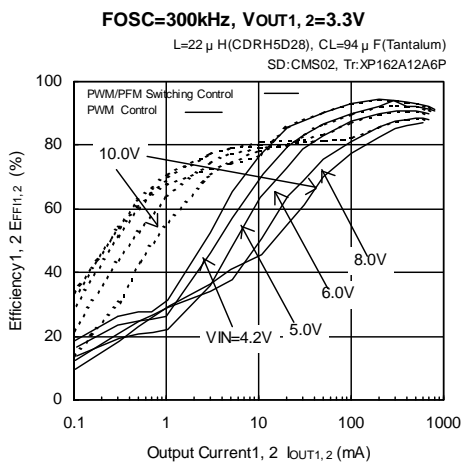

* When setting VOUT1,2=1.0V, VIN=8.0V, 10.0V,
 CL should be 94 μ F (Tantalum) + 100 μ F (OS-COM)

TYPICAL PERFORMANCE CHARACTERISTICS (Continued)

(2) Efficiency vs. Output Current (Continued)

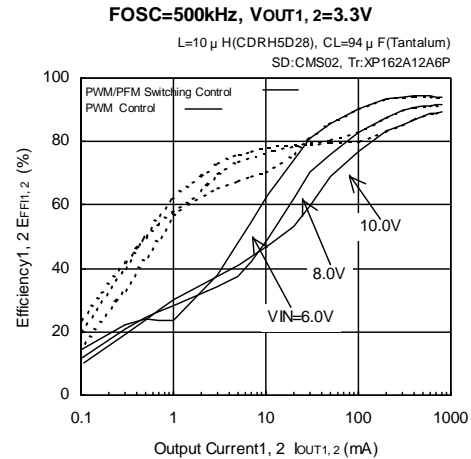
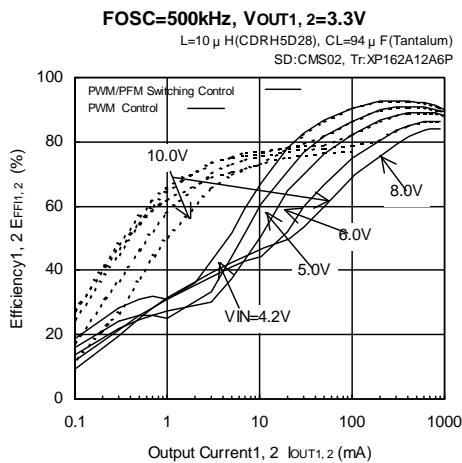
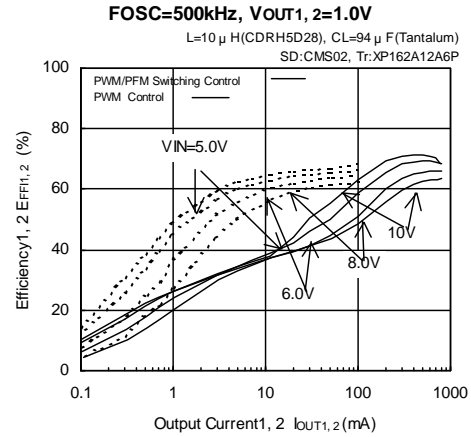
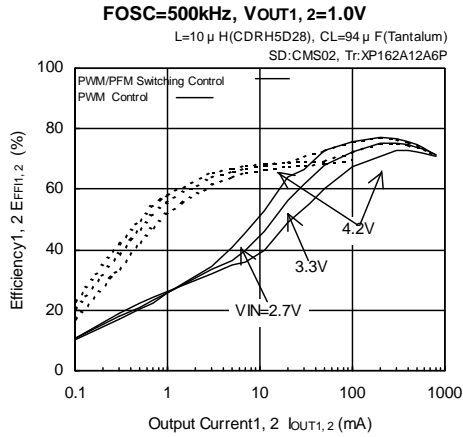

* When setting VOUT1,2=1.0V, VIN=8.0V, 10.0V,
 CL should be 94 μ F (Tantalum) + 100 μ F (OS-COM)

TYPICAL PERFORMANCE CHARACTERISTICS (Continued)

(3) Ripple Voltage vs. Output Current

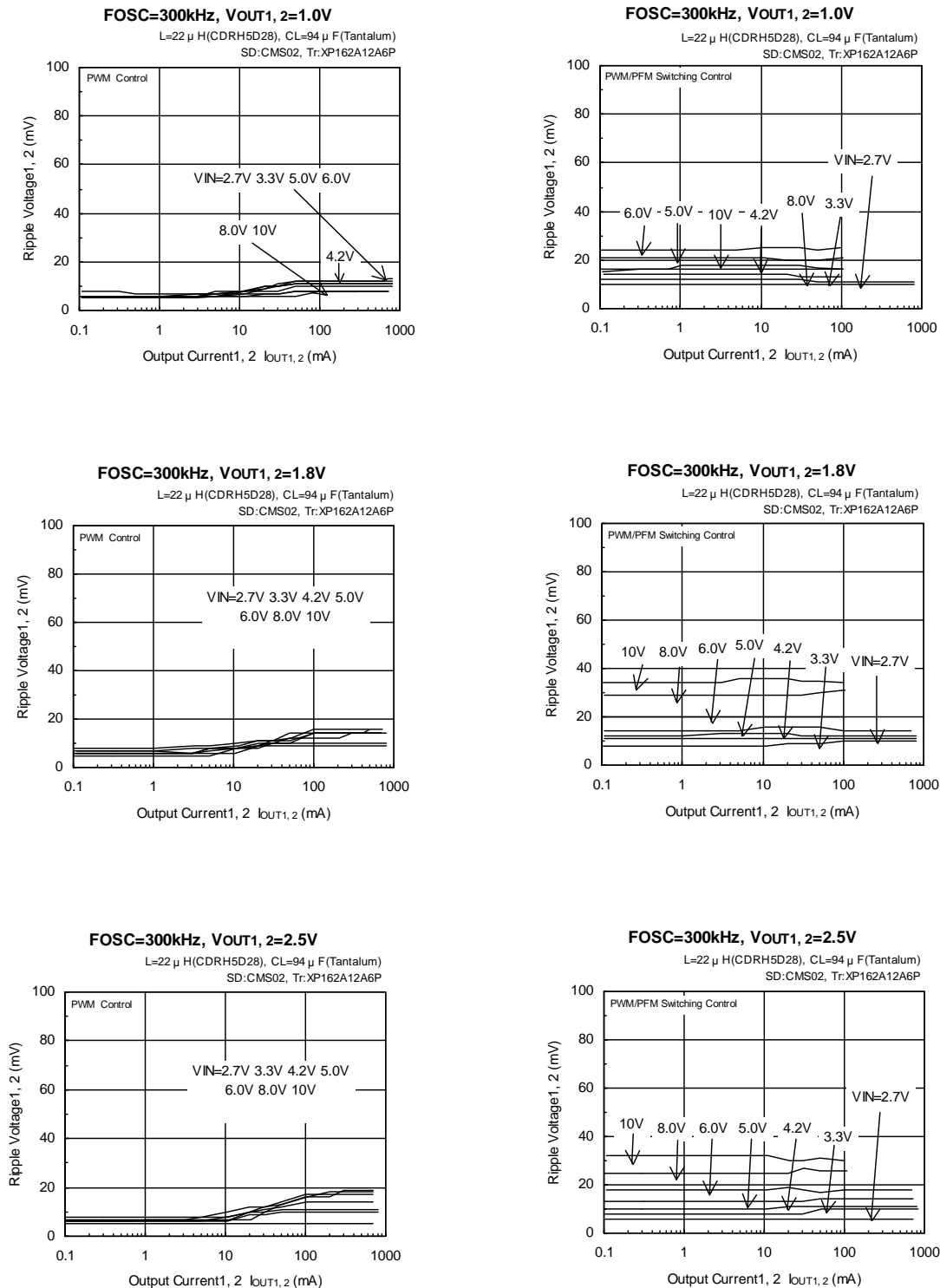

* When setting $VOUT1, 2=1.0V$, $VIN=8.0V, 10.0V$, CL should be $94\mu F$ (Tantalum) + $100\mu F$ (OS-COM)

TYPICAL PERFORMANCE CHARACTERISTICS (Continued)

(3) Ripple Voltage vs. Output Current (Continued)

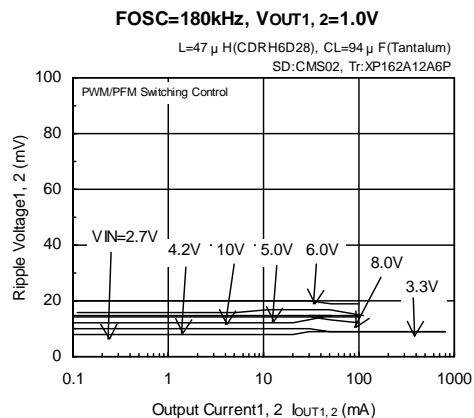
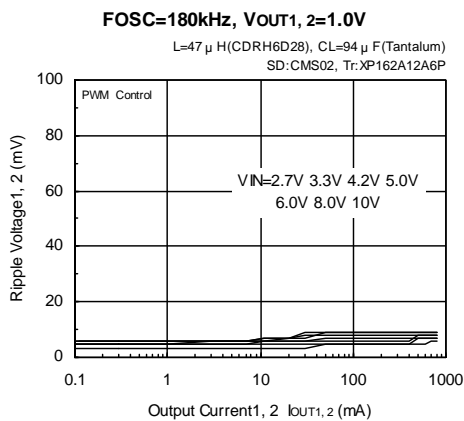
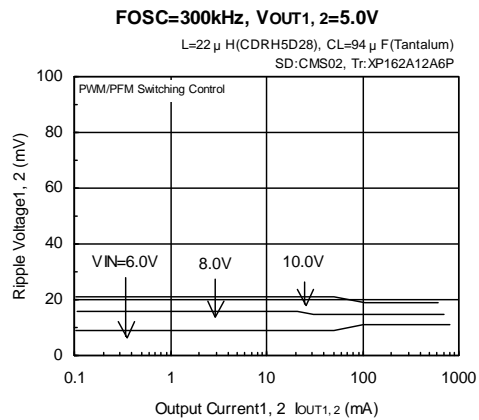
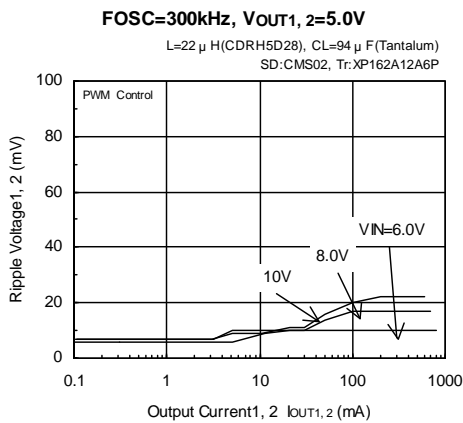
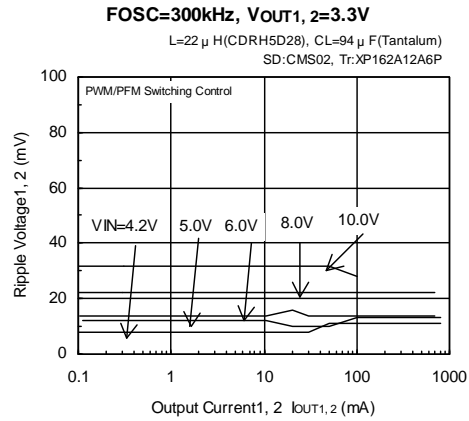
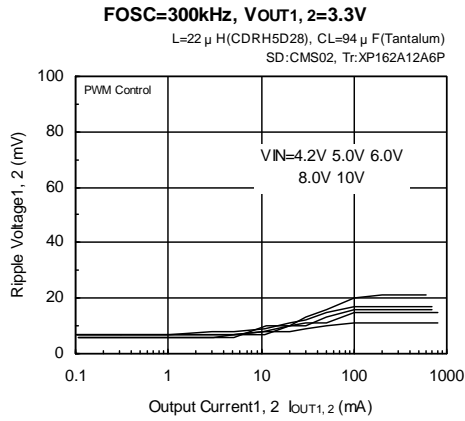

* When setting VOUT1,2=1.0V, VIN=8.0V, 10.0V,
 CL should be 94 μ F (Tantalum) + 100 μ F (OS-COM)

TYPICAL PERFORMANCE CHARACTERISTICS (Continued)

(3) Ripple Voltage vs. Output Current (Continued)

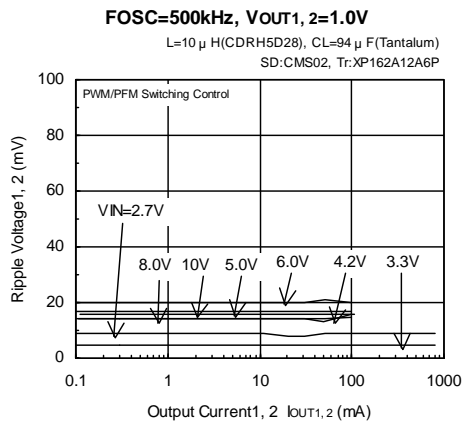
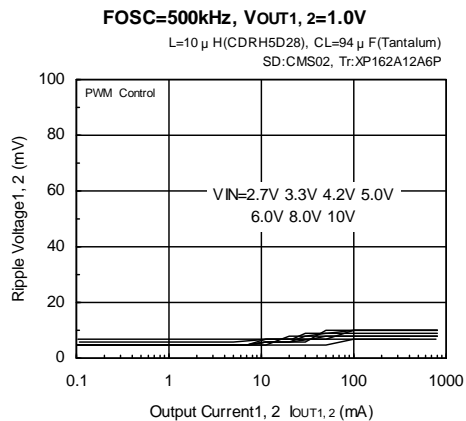
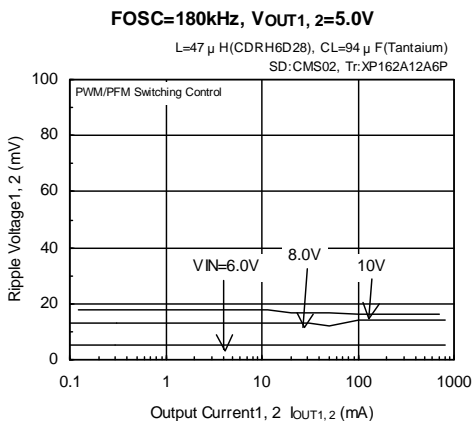
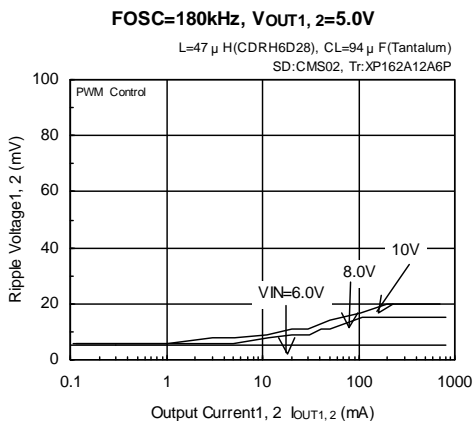
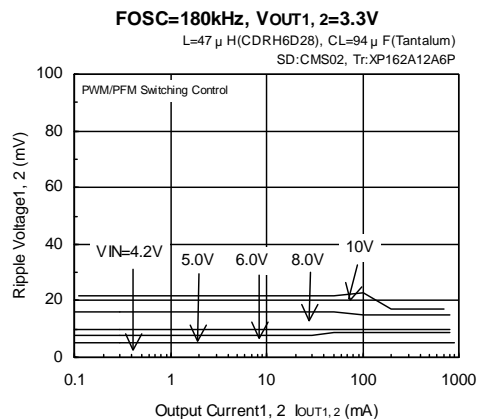
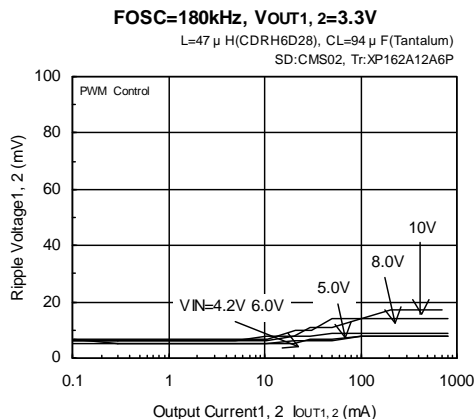

* When setting VOUT1, 2=1.0V, VIN=8.0V, 10.0V,
CL should be 94 μ F (Tantalum) + 100 μ F (OS-COM)

TYPICAL PERFORMANCE CHARACTERISTICS (Continued)

(3) Ripple Voltage vs. Output Current (Continued)

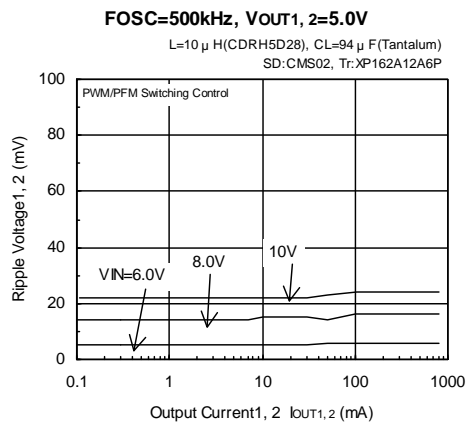
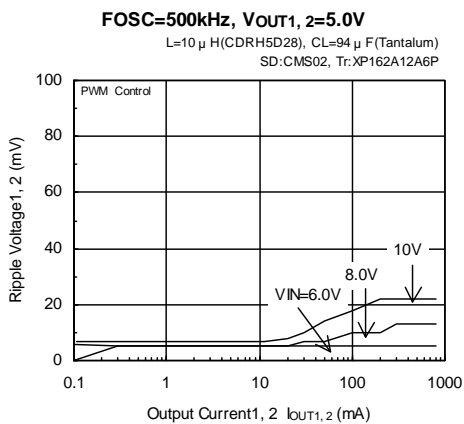
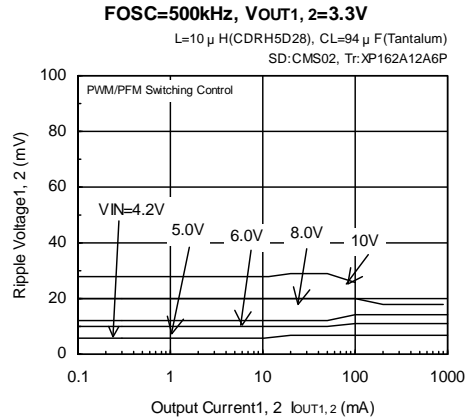
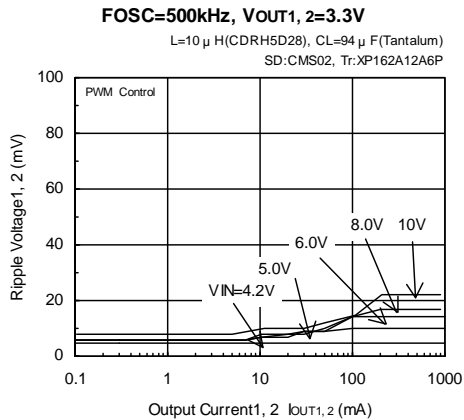

TYPICAL PERFORMANCE CHARACTERISTICS (Continued)

(4) Supply Current 1 vs. Supply Voltage

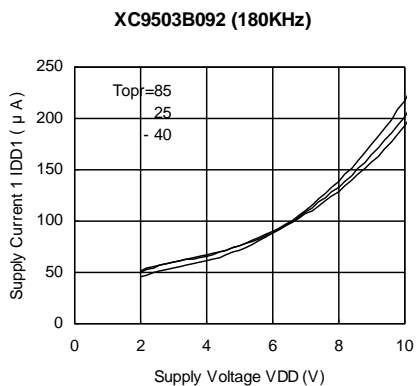

(5) Supply Current 1_1 vs. Supply Voltage

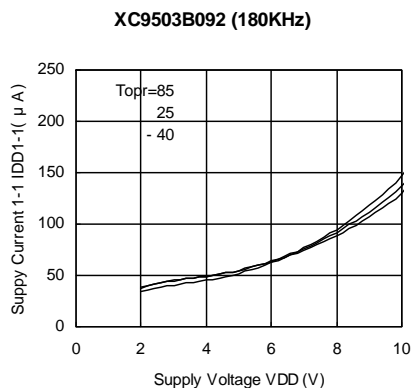

(6) Supply Current 1_2 vs. Supply Voltage

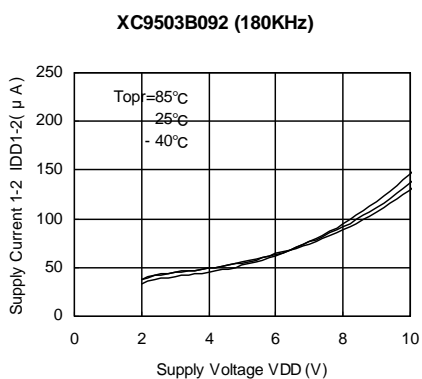

(7) Supply Current 2 vs. Supply Voltage

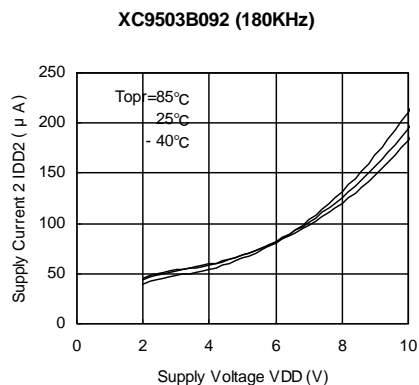

(8) Stand-by Current vs. Supply Voltage

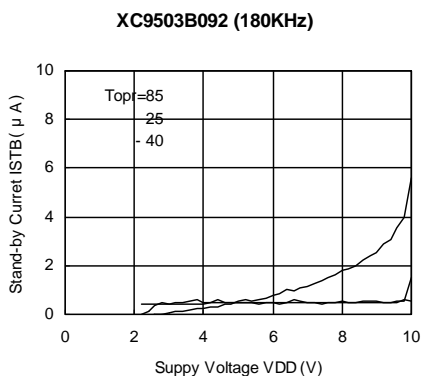

(9) Oscillation Frequency vs. Supply Voltage

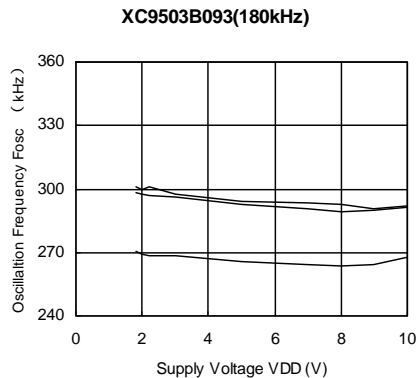

TYPICAL PERFORMANCE CHARACTERISTICS (Continued)

(10) EN1, 2 'High' 'Low' Voltage vs. Supply Voltage

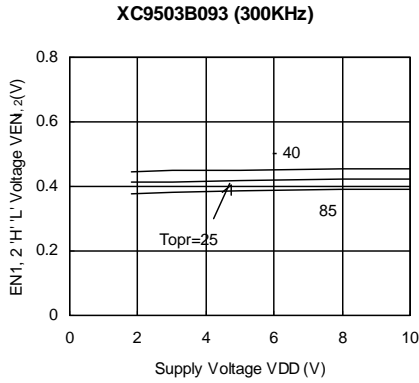

(11) PWM1, 2 'High' 'Low' Voltage vs. Supply Voltage

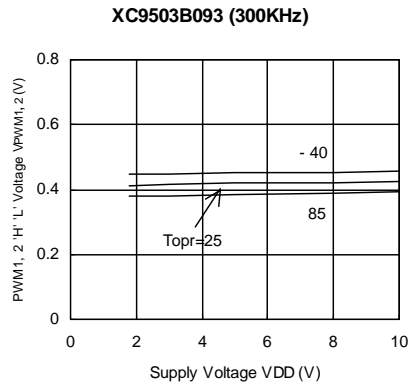

(12) PFM Duty Ratio 1, 2 vs. Supply Voltage

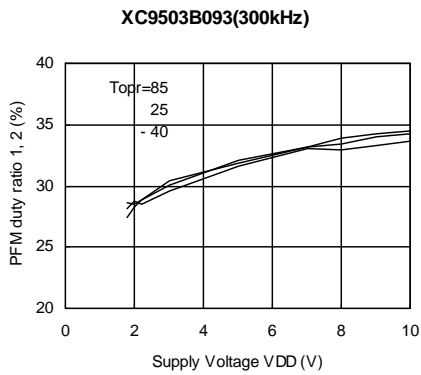

(13) Output Voltage vs. Ambient Temperature

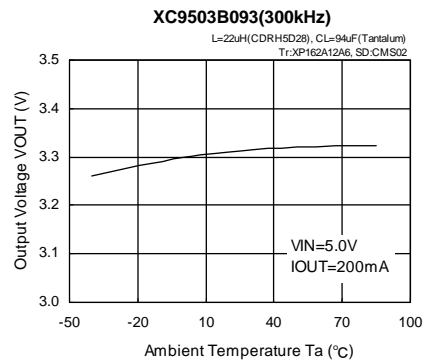

(14) EXT1, 2 'High' On Resistance vs. Supply Voltage

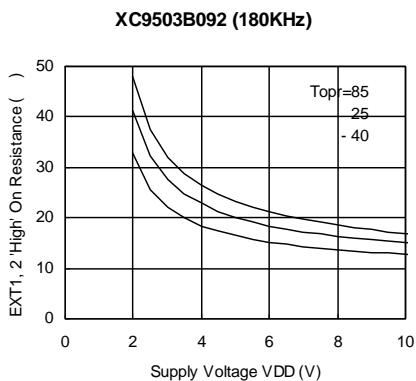

(15) EXT1, 2 'Low' On Resistance vs. Supply Voltage

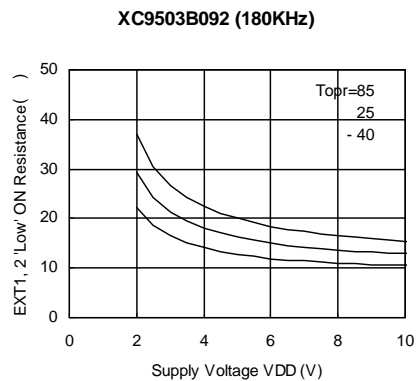

TYPICAL PERFORMANCE CHARACTERISTICS (Continued)

(16) Soft-Start Time 1, 2 vs. Supply Voltage

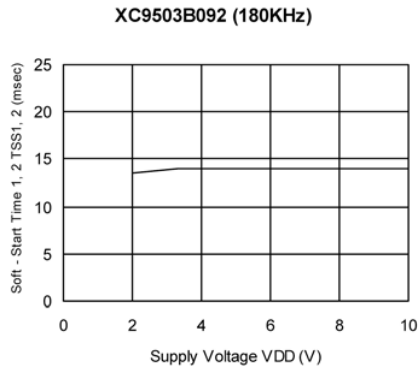

TYPICAL PERFORMANCE CHARACTERISTICS (Continued)

(17) Load Transient Response

< $V_{OUT1,2} = 3.3V$, $V_{IN} = 5.0V$, $I_{OUT1,2} = 100\mu A$ $300mA$ >

PWM Control

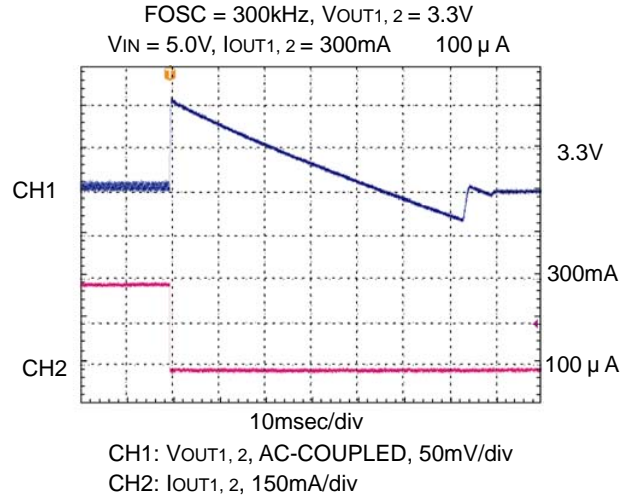
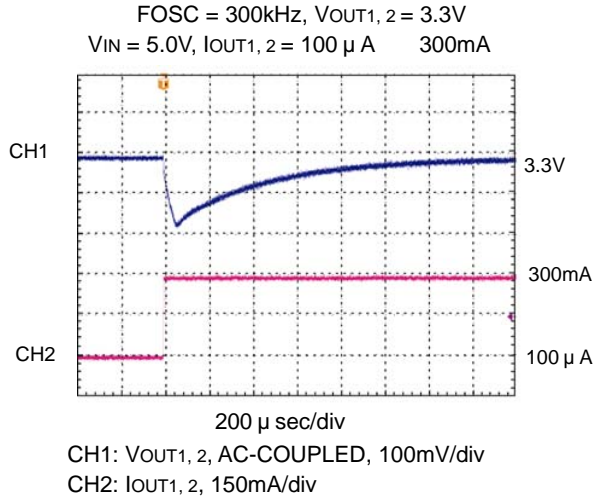

PWM/PFM Switching Control

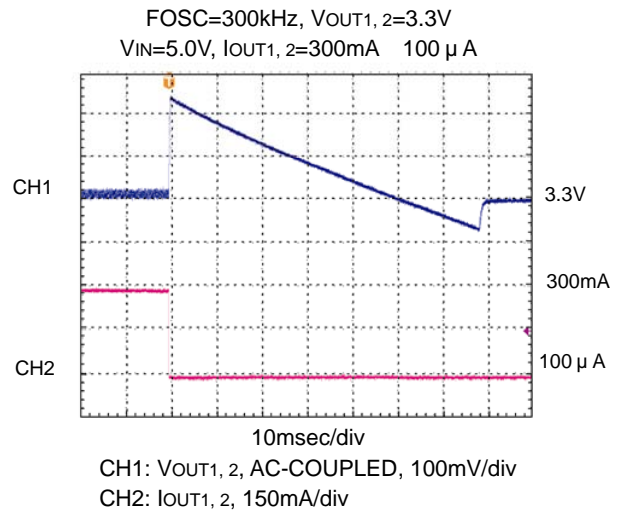
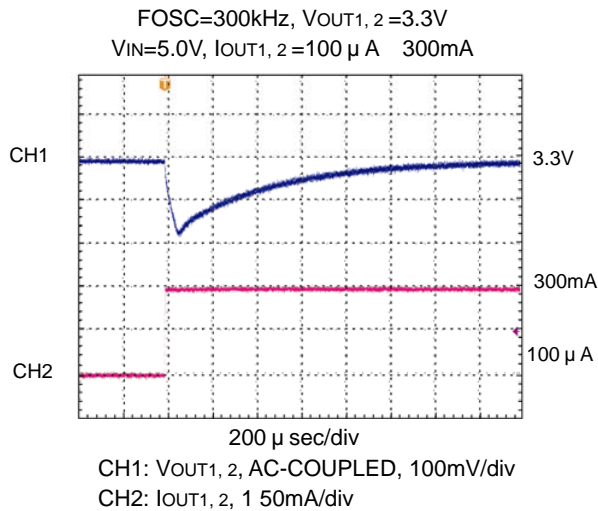

TYPICAL PERFORMANCE CHARACTERISTICS (Continued)

(17) Load Transient Response (Continued)

< $V_{OUT1,2} = 3.3V$, $V_{IN} = 5.0V$, $I_{OUT1,2} = 10mA$ 300mA >

PWM Control

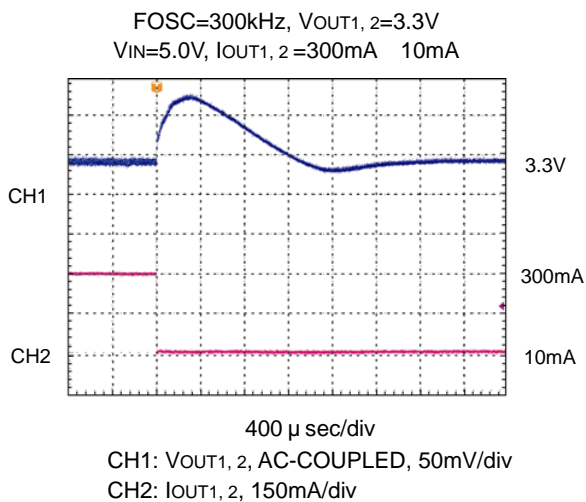
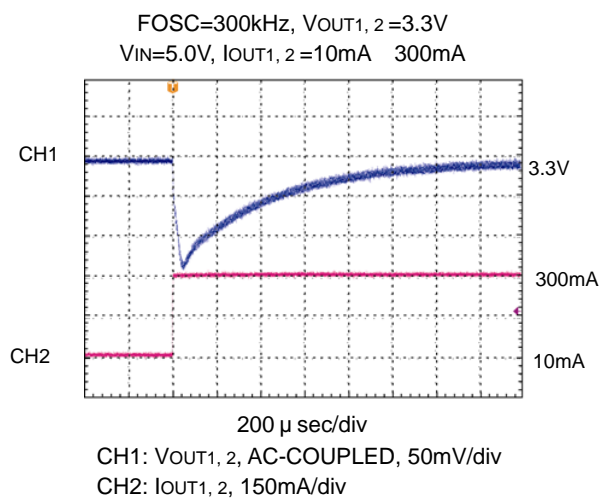

PWM/PFM Switching Control

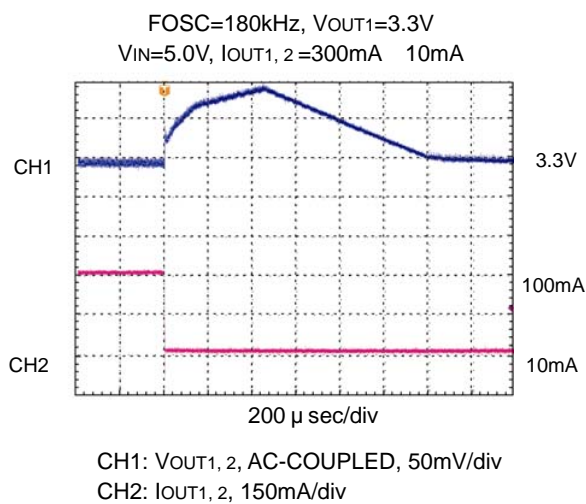
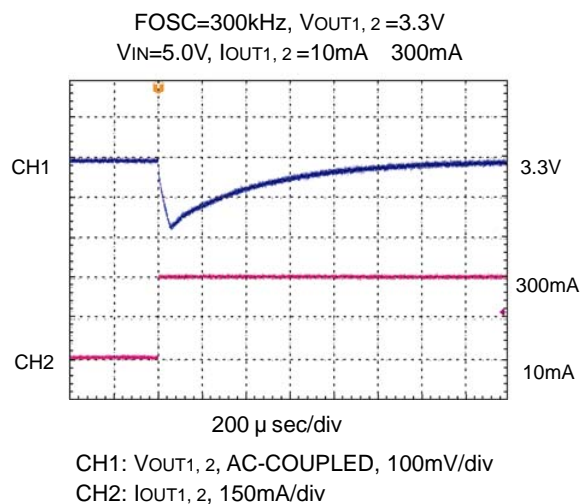

TYPICAL PERFORMANCE CHARACTERISTICS (Continued)

(17) Load Transient Response (Continued)

< $V_{OUT1,2} = 0.9V$, $V_{IN} = 3.3V$, $I_{OUT1,2} = 100\mu A$ 300mA >

PWM Control

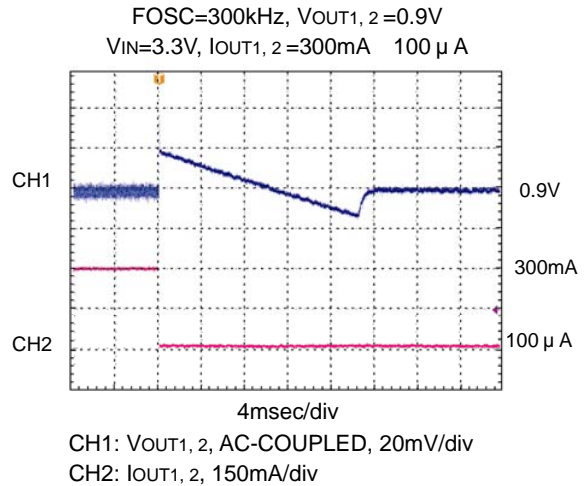
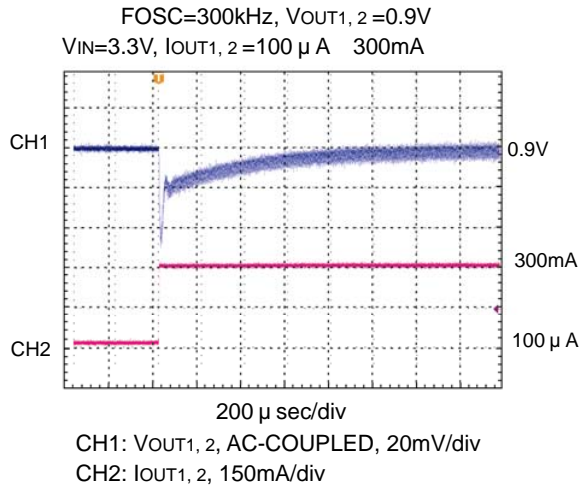

PWM/PFM Switching Control

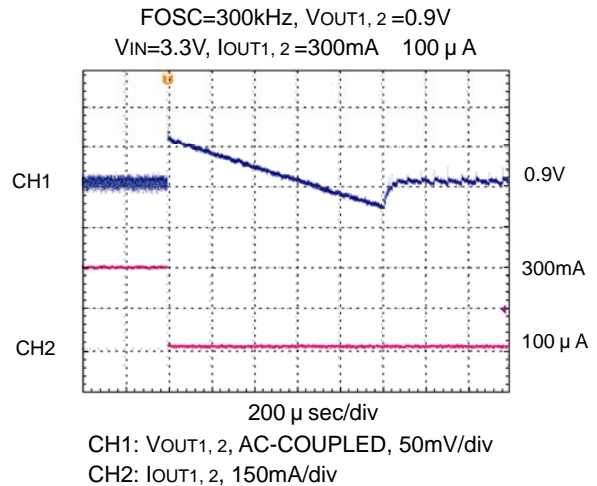
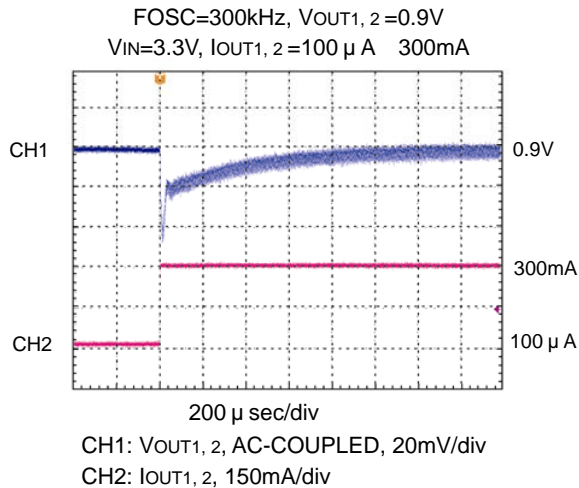

TYPICAL PERFORMANCE CHARACTERISTICS (Continued)

(17) Load Transient Response (Continued)

< $V_{OUT1,2} = 0.9V$, $V_{IN} = 3.3V$, $I_{OUT1,2} = 10mA$ 300mA >

PWM Control

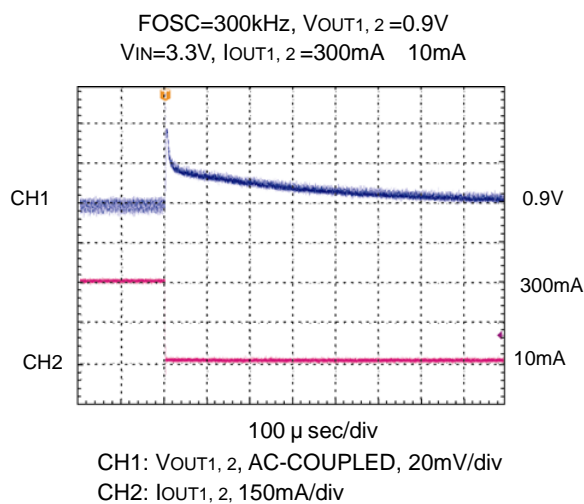
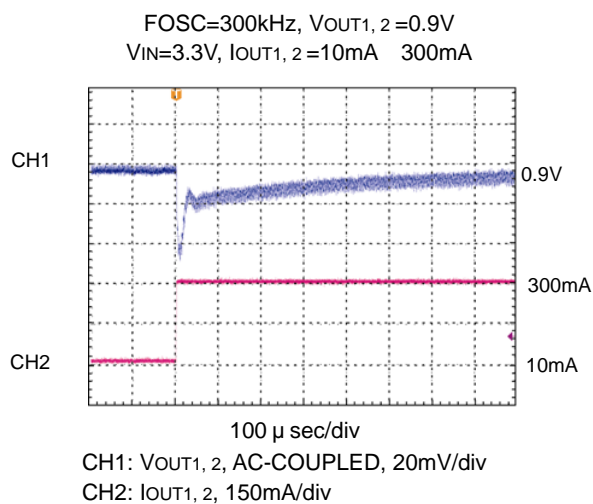

PWM/PFM Switching Control

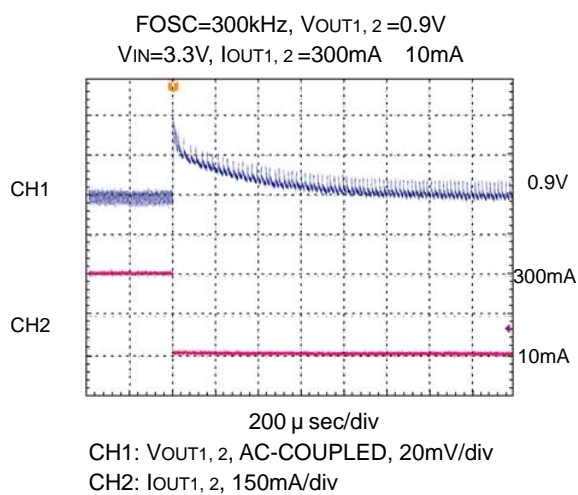
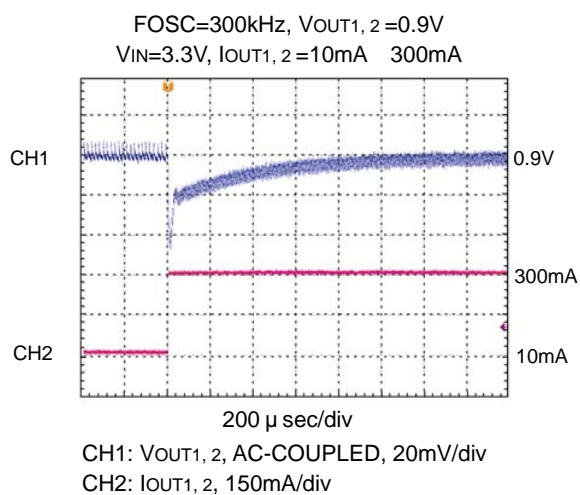

TYPICAL PERFORMANCE CHARACTERISTICS (Continued)

(17) Load Transient Response (Continued)

< PWM Control PWM / PFM Switching Control >

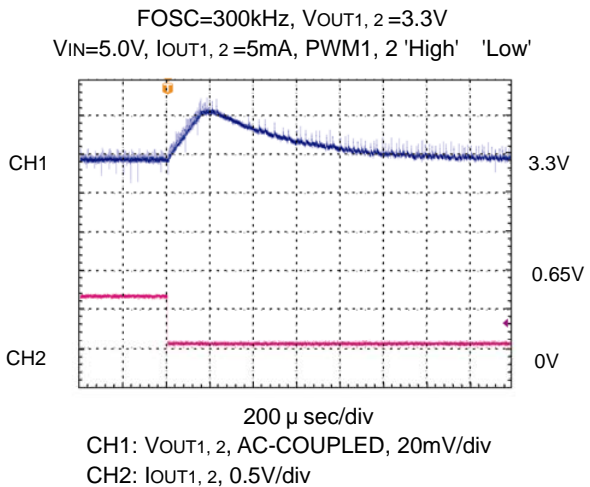
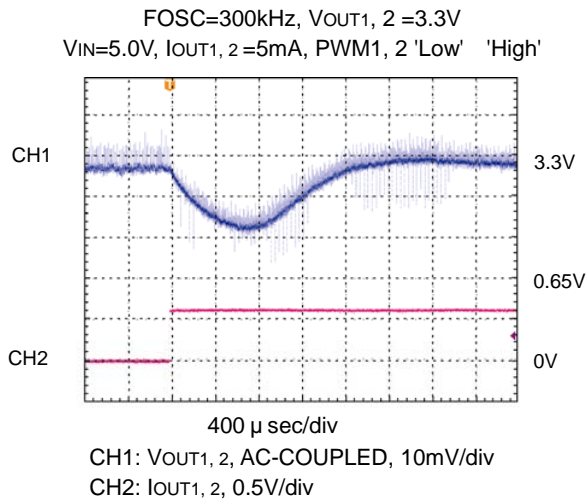

< Soft-Start Wave Form >

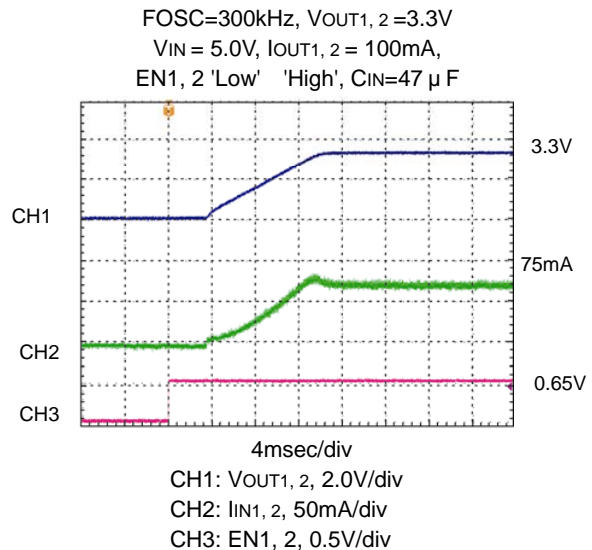
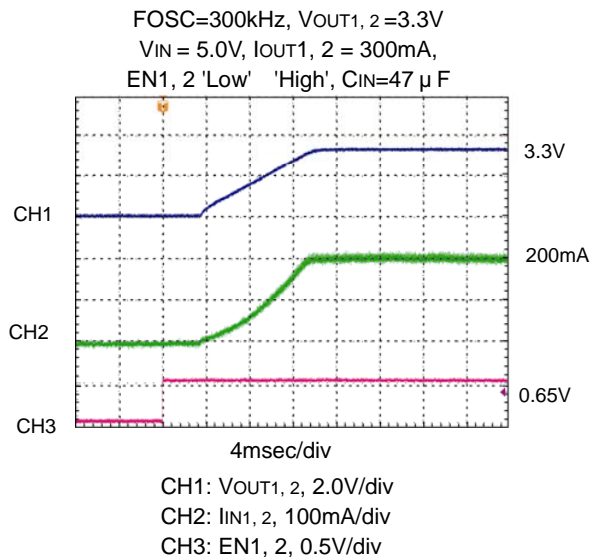

* CH1: EN2=GND when measurement
CH2: EN1=GND when measurement

PACKAGING INFORMATION

MSOP-10

Unit : mm

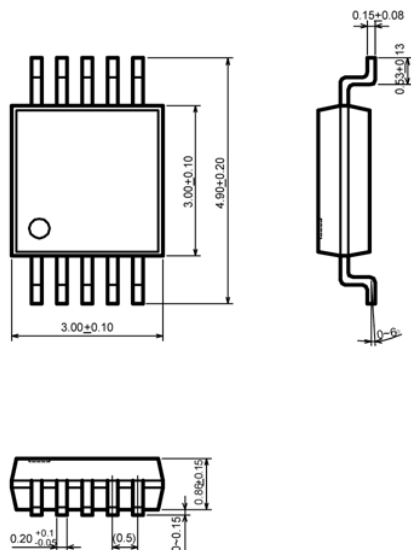

USP-10

Unit : mm

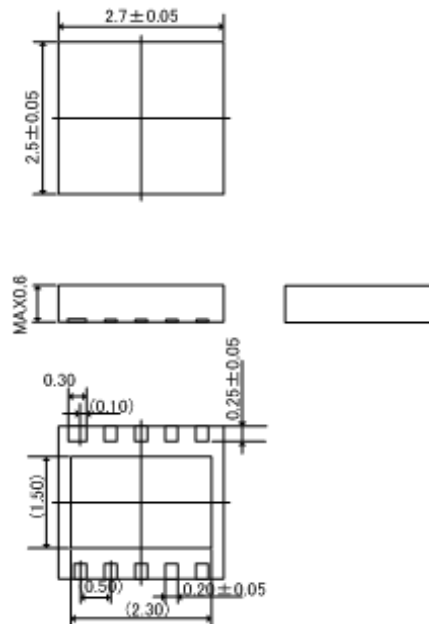

MARKING RULE

MSOP-10, USP-10

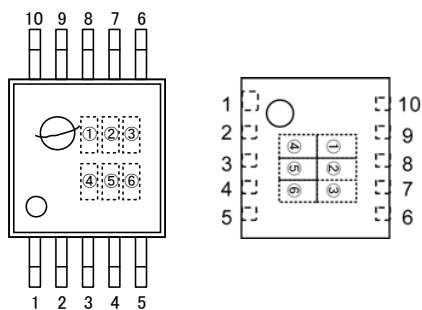

MSOP-10
(TOP VIEW)

USP-10
(TOP VIEW)

represents product series

MARK	PRODUCT SERIES
4	XC9503B09xxx

represents type of DC/DC controller

MARK	PRODUCT SERIES
B	XC9503B09xxx

represents FB voltage

MARK		VOLTAGE (V)	PRODUCT SERIES
0	9	0.9	XC9503B09xxx

represents oscillation frequency

MARK	OSCILLATION FREQUENCY (kHz)	PRODUCT SERIES
2	180	XC9503B092xx
3	300	XC9503B093xx
5	500	XC9503B095xx

represents production lot number

0 to 9, A to Z repeated (G, I, J, O, Q, W excluded)

Note: No character inversion used.

1. The products and product specifications contained herein are subject to change without notice to improve performance characteristics. Consult us, or our representatives before use, to confirm that the information in this datasheet is up to date.
2. We assume no responsibility for any infringement of patents, patent rights, or other rights arising from the use of any information and circuitry in this datasheet.
3. Please ensure suitable shipping controls (including fail-safe designs and aging protection) are in force for equipment employing products listed in this datasheet.
4. The products in this datasheet are not developed, designed, or approved for use with such equipment whose failure or malfunction can be reasonably expected to directly endanger the life of, or cause significant injury to, the user.
(e.g. Atomic energy; aerospace; transport; combustion and associated safety equipment thereof.)
5. Please use the products listed in this datasheet within the specified ranges.
Should you wish to use the products under conditions exceeding the specifications, please consult us or our representatives.
6. We assume no responsibility for damage or loss due to abnormal use.
7. All rights reserved. No part of this datasheet may be copied or reproduced without the prior permission of TOREX SEMICONDUCTOR LTD.

TOREX SEMICONDUCTOR LTD.