

LM3102

SIMPLE SWITCHER® Synchronous 1MHz 2.5A Step-Down Voltage Regulator

General Description

The LM3102 Synchronously Rectified Buck Converter features all required functions to implement a highly efficient and cost effective buck regulator. It is capable of supplying 2.5A to loads with an output voltage as low as 0.8V. Dual N-Channel synchronous MOSFET switches allow a low component count, thus reducing complexity and minimizing board size.

Different from most other COT regulators, the LM3102 does not rely on output capacitor ESR for stability, and is designed to work exceptionally well with ceramic and other very low ESR output capacitors. It requires no loop compensation, results in a fast load transient response and simple circuit implementation. The operating frequency remains nearly constant with line variations due to the inverse relationship between the input voltage and the on-time. The operating frequency can be externally programmed up to 1 MHz. Protection features include V_{CC} under-voltage lock-out, output over-voltage protection, thermal shutdown, and gate drive under-voltage lock-out. The LM3102 is available in the thermally enhanced eTSSOP-20 package as well as a uSMD low profile chip-scale package with reduced output current.

Key Specifications

- Input voltage range 4.5V-42V
- 2.5A output current
- 0.8V, $\pm 1.5\%$ reference
- Integrated dual N-Channel main and synchronous MOSFETs
- Thermally enhanced eTSSOP-20 package

Features

- Low component count and small solution size
- Stable with ceramic and other low ESR capacitors
- No loop compensation required
- High efficiency at a light load by DCM operation
- Pre-bias startup
- Ultra-fast transient response
- Programmable soft-start
- Programmable switching frequency up to 1 MHz
- Valley current limit
- Output over-voltage protection
- Precision internal reference for an adjustable output voltage down to 0.8V
- Thermal shutdown

Typical Applications

- 5VDC, 12VDC, 24VDC, 12VAC, and 24VAC systems
- Embedded Systems
- Industrial Control
- Automotive Telematics and Body Electronics
- Point of Load Regulators
- Storage Systems
- Broadband Infrastructure
- Direct Conversion from 2/3/4 Cell Lithium Batteries Systems

Typical Application

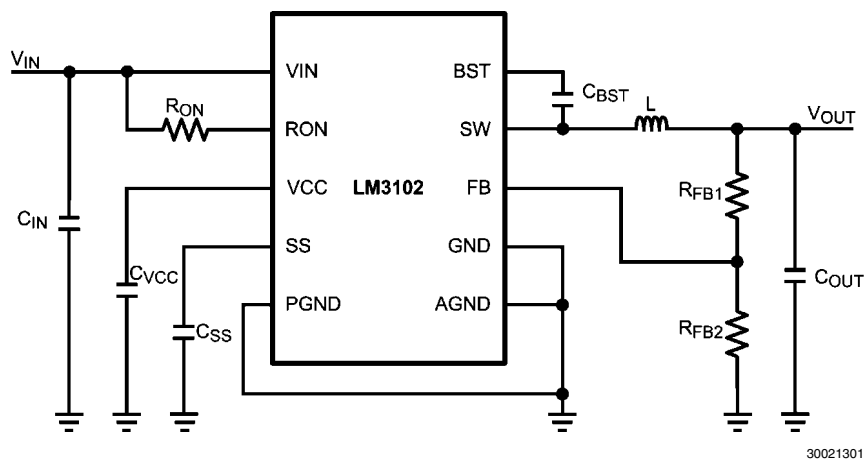

SIMPLE SWITCHER® is a registered trademark of National Semiconductor Corporation

Connection Diagrams

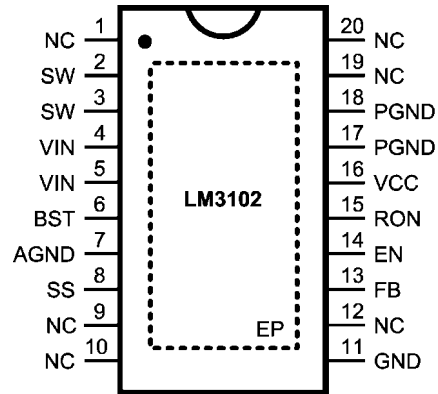

30021302
20-lead Plastic eTSSOP
NS Package Number MXA20A

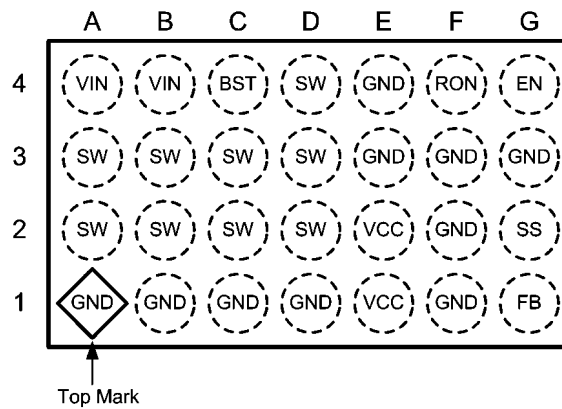

30021369
28-ball μBGA — Balls Facing Down
NS Package Number TLC28VFA

Ordering Information

Order Number	Package Type	NSC Package Drawing	Supplied As
LM3102MH	Exposed Pad TSSOP-20	MXA0020	73 units per Anti-Static Tube
LM3102MHX			2500 Units on Tape and Reel
LM3102TL-1	28-ball μSMD	TLC28VFA	250 Units on Tape and Reel
LM3102TLX-1	28-ball μSMD	TLC28VFA	3000 Units on Tape and Reel

Pin Descriptions

Pin	Ball	Name	Description	Application Information
1,9,10,12,19,20		N/C	No Connection	These pins must be left unconnected.
2, 3	A2, A3, B2, B3, C2, C3, D2, D3, D4	SW	Switching Node	Internally connected to the source of the main MOSFET and the drain of the Synchronous MOSFET. Connect to the inductor.
4, 5	A4, B4	VIN	Input supply voltage	Supply pin to the device. Nominal input range is 4.5V to 42V.
6	C4	BST	Connection for bootstrap capacitor	Connect a 33 nF capacitor from the SW pin to this pin. An internal diode charges the capacitor during the main MOSFET off-time.
7	E3, E4, F1, F2, F3, G3	AGND	Analog Ground	Ground for all internal circuitry other than the PGND pin.
8	G2	SS	Soft-start	An 8 μ A internal current source charges an external capacitor to provide the soft- start function.
11		GND	Ground	Must be connected to the AGND pin for normal operation. The GND and AGND pins are not internally connected.
13	G1	FB	Feedback	Internally connected to the regulation and over-voltage comparators. The regulation setting is 0.8V at this pin. Connect to feedback resistors.
14	G4	EN	Enable pin	Connect a voltage higher than 1.26V to enable the regulator.
15	F4	RON	On-time Control	An external resistor from the VIN pin to this pin sets the main MOSFET on-time.
16	E1, E2	VCC	Start-up regulator Output	Nominally regulated to 6V. Connect a capacitor of not less than 680 nF between the VCC and AGND pins for stable operation.
17, 18	A1, B1, C1, D1	PGND	Power Ground	Synchronous MOSFET source connection. Tie to a ground plane.
EP		EP	Exposed Pad	Thermal connection pad. Connect to the ground plane.

Absolute Maximum Ratings (Note 1)

If Military/Aerospace specified devices are required, please contact the National Semiconductor Sales Office/ Distributors for availability and specifications.

VIN, RON to AGND	-0.3V to 43.5V
SW to AGND	-0.3V to 43.5V
SW to AGND (Transient)	-2V (< 100ns)
VIN to SW	-0.3V to 43.5V
BST to SW	-0.3V to 7V
All Other Inputs to AGND	-0.3V to 7V
ESD Rating (Note 2)	
Human Body Model	±2kV

Storage Temperature Range	-65°C to +150°C
Junction Temperature (T _J)	150°C

Operating Ratings (Note 1)

Supply Voltage Range (VIN)	4.5V to 42V
Junction Temperature Range (T _J)	-40°C to +125°C
Thermal Resistance (θ _{JC}) 20 lead eTSSOP (Note 3)	6.5°C/W
Thermal Resistance (θ _{JA}) 20 lead eTSSOP (Note 5)	30°C/W
Thermal Resistance (θ _{JA}) 28 ball μSMD (Note 5)	50°C/W

Electrical Characteristics Specifications with standard type are for T_J = 25°C only; limits in **boldface type** apply over the full Operating Junction Temperature (T_J) range. Minimum and Maximum limits are guaranteed through test, design, or statistical correlation. Typical values represent the most likely parametric norm at T_J = 25°C, and are provided for reference purposes only. Unless otherwise stated the following conditions apply: V_{IN} = 18V, V_{OUT} = 3.3V.

Symbol	Parameter	Conditions	Min	Typ	Max	Units
Start-Up Regulator, V_{CC}						
V _{CC}	V _{CC} output voltage	C _{CC} = 680nF, no load	5.0	6.0	7.2	V
V _{IN} - V _{CC}	V _{IN} - V _{CC} dropout voltage	I _{CC} = 2mA		50	200	mV
		I _{CC} = 20mA		350	570	
I _{VCC}	V _{CC} current limit (Note 4)	V _{CC} = 0V	40	65		mA
V _{CC-UVLO}	V _{CC} under-voltage lockout threshold (UVLO)	V _{IN} increasing	3.6	3.75	3.9	V
V _{CC-UVLO-HYS}	V _{CC} UVLO hysteresis	V _{IN} decreasing – TSSOP package		130		mV
V _{CC-UVLO-HYS}	V _{CC} UVLO hysteresis	V _{IN} decreasing – μSMD package		150		mV
t _{VCC-UVLO-D}	V _{CC} UVLO filter delay			3		μs
I _{IN}	I _{IN} operating current	No switching, V _{FB} = 1V		0.7	1	mA
I _{IN-SD}	I _{IN} operating current, Device shutdown	V _{EN} = 0V		25	40	μA
Switching Characteristics						
R _{DS-UP-ON}	Main MOSFET R _{DS(on)}			0.18	0.375	Ω
R _{DS-DN-ON}	Syn. MOSFET R _{DS(on)}			0.11	0.225	Ω
V _{G-UVLO}	Gate drive voltage UVLO	V _{BST} - V _{SW} increasing		3.3	4	V
Soft-start						
I _{SS}	SS pin source current	V _{SS} = 0.5V	6	8	10	μA
Current Limit						
I _{CL}	Syn. MOSFET current limit threshold	LM3102		2.7		A
I _{CL}	Syn. MOSFET current limit threshold	LM3102TLX-1		1.5		A
ON/OFF Timer						
t _{on}	ON timer pulse width	V _{IN} = 10V, R _{ON} = 100 kΩ		1.38		μs
		V _{IN} = 30V, R _{ON} = 100 kΩ		0.47		
t _{on-MIN}	ON timer minimum pulse width			150		ns
t _{off}	OFF timer pulse width			260		ns
Enable Input						
V _{EN}	EN Pin input threshold	V _{EN} rising	1.13	1.18	1.23	V
V _{EN-HYS}	Enable threshold hysteresis	V _{EN} falling		90		mV
Regulation and Over-Voltage Comparator						
V _{FB}	In-regulation feedback voltage	V _{SS} ≥ 0.8V T _J = -40°C to +125°C	0.784	0.8	0.816	V

Symbol	Parameter	Conditions	Min	Typ	Max	Units
		$V_{SS} \geq 0.8V$ $T_J = 0^\circ C \text{ to } +125^\circ C$	0.788		0.812	
V_{FB-OV}	Feedback over-voltage threshold		0.888	0.920	0.945	V
I_{FB}				5		nA
Thermal Shutdown						
T_{SD}	Thermal shutdown temperature	T_J rising		165		$^\circ C$
T_{SD-HYS}	Thermal shutdown temperature hysteresis	T_J falling		20		$^\circ C$

Note 1: Absolute Maximum Ratings are limits beyond which damage to the device may occur. Operating Ratings are conditions under which operation of the device is intended to be functional. For guaranteed specifications and test conditions, see the Electrical Characteristics.

Note 2: The human body model is a 100pF capacitor discharged through a 1.5k Ω resistor into each pin.

Note 3: θ_{JC} measurements are performed in general accordance with Mil-Std 883B, Method 1012.1 and utilizes the copper heat sink technique. Copper Heat Sink @ 60 $^\circ C$.

Note 4: V_{CC} provides self bias for the internal gate drive and control circuits. Device thermal limitations limit external loading.

Note 5: θ_{JA} measurements were performed in general accordance with JEDEC standards JESD51-1 to JESD51-11.

Typical Performance Characteristics

All curves are taken at $V_{IN} = 18V$ with the configuration in the typical application circuit for $V_{OUT} = 3.3V$ shown in this datasheet. $T_A = 25^\circ C$, unless otherwise specified.

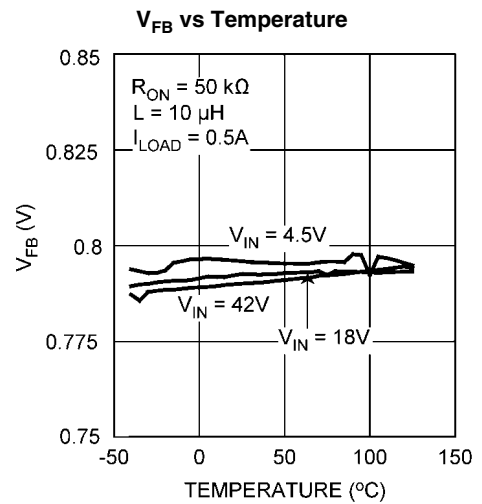
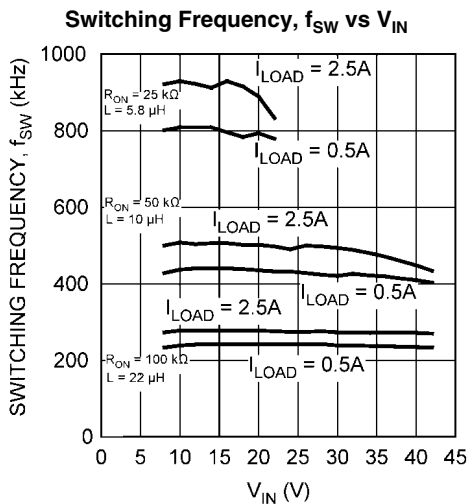
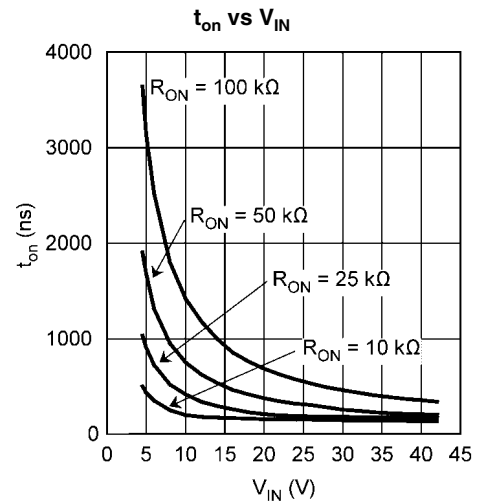
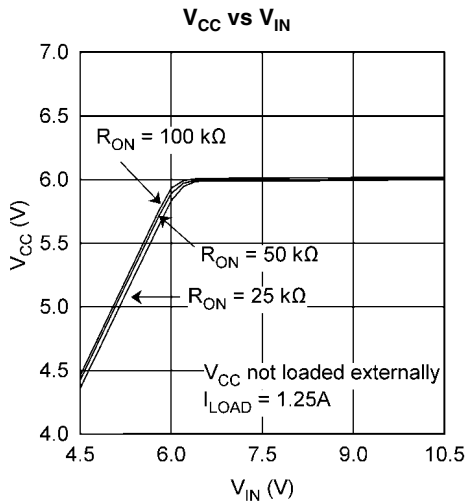
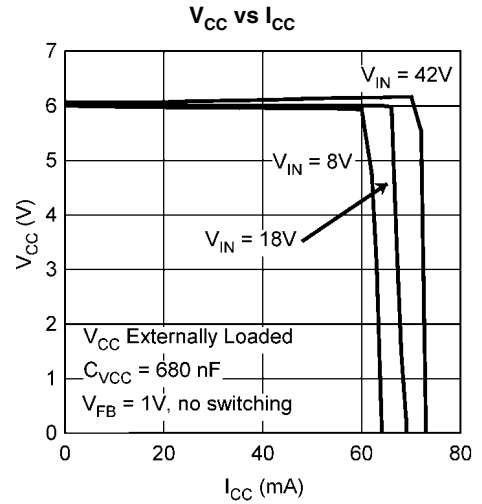
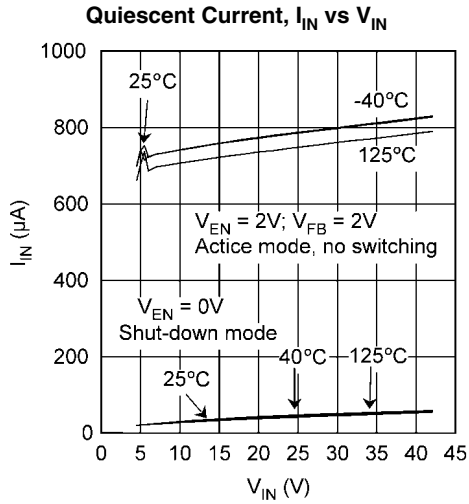

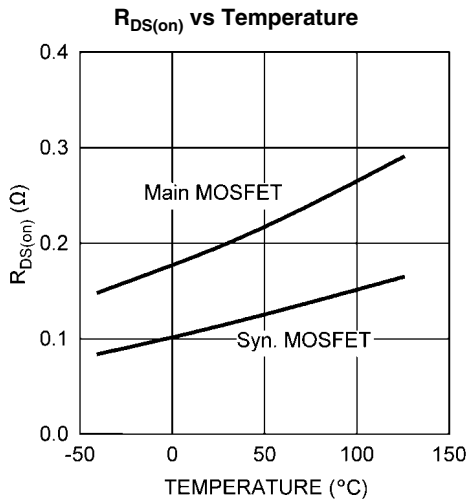

30021309

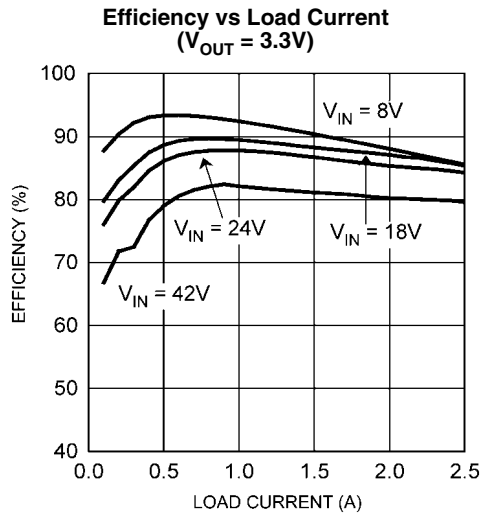

30021310

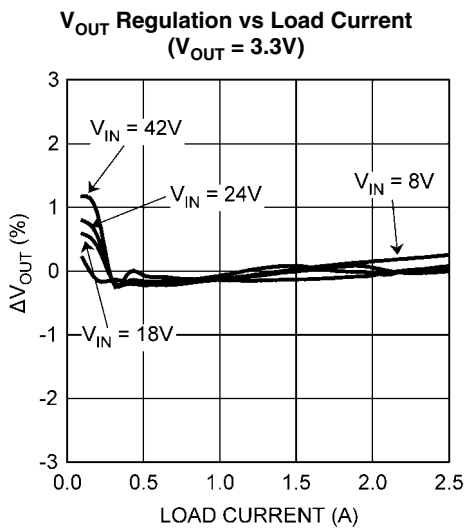

30021311

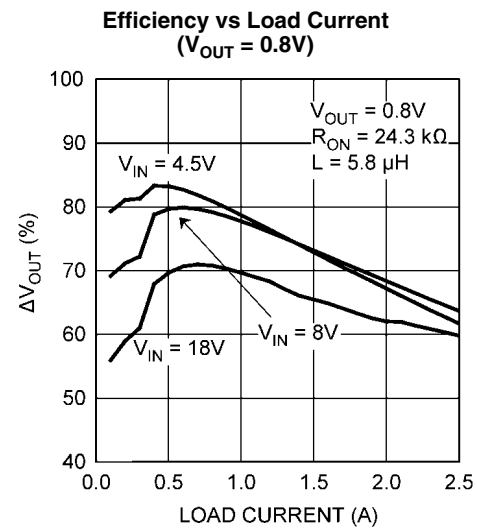

30021312

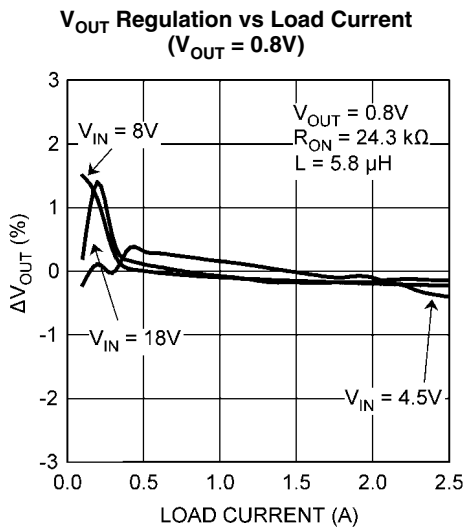

30021313

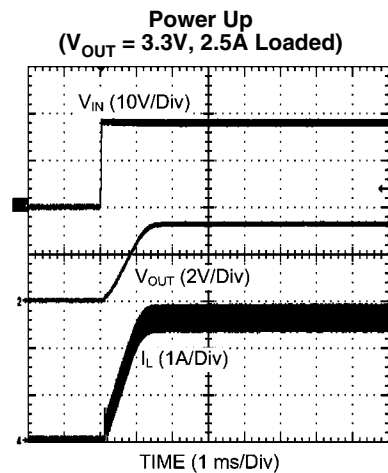

30021339

Enable Transient
($V_{OUT} = 3.3V$, 2.5A Loaded)

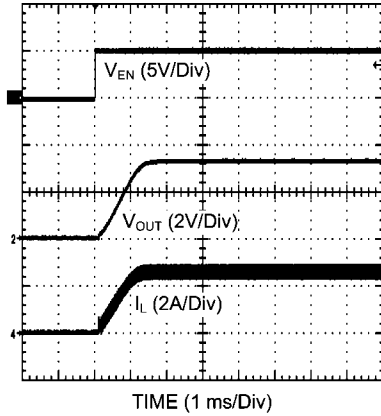

30021314

Shutdown Transient
($V_{OUT} = 3.3V$, 2.5A Loaded)

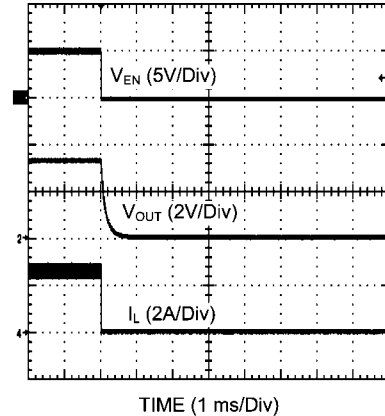

30021315

Continuous Mode Operation
($V_{OUT} = 3.3V$, 2.5A Loaded)

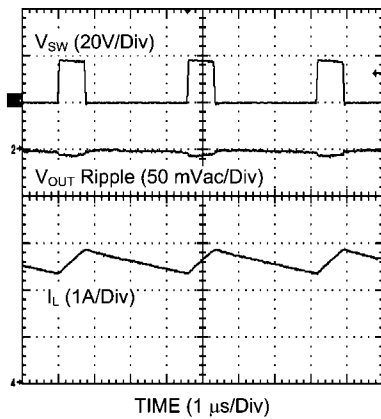

30021316

Discontinuous Mode Operation
($V_{OUT} = 3.3V$, 0.025A Loaded)

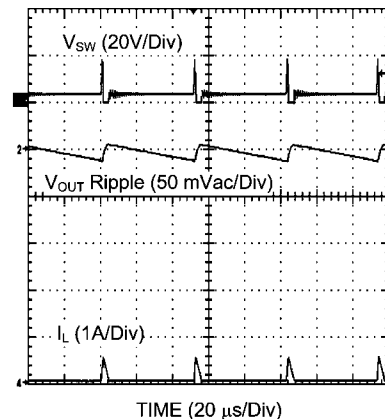

30021317

DCM to CCM Transition
($V_{OUT} = 3.3V$, 0.15A - 2.5A Load)

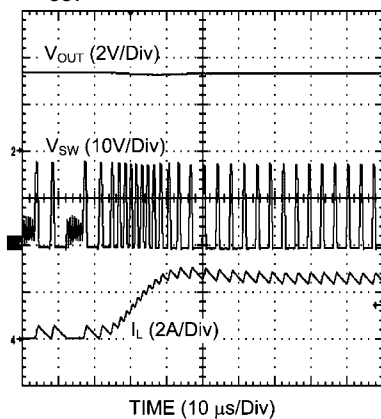

30021318

Load Transient
($V_{OUT} = 3.3V$, 0.25A - 2.5A Load, Current slew-rate: 2.5A/μs)

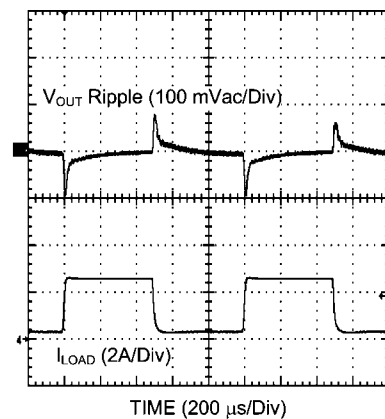

30021319

uSMD Valley Current Limit $V_{OUT} = 5.0V @ 25^{\circ}C$

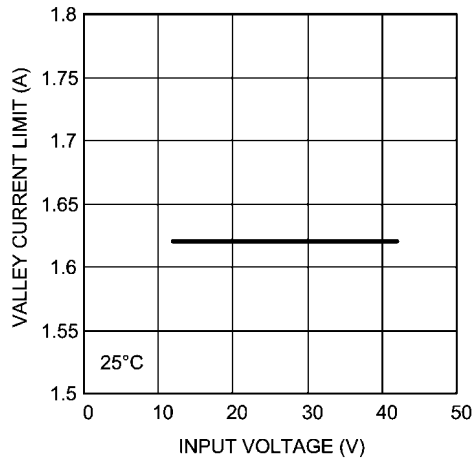

30021354

Simplified Functional Block Diagram

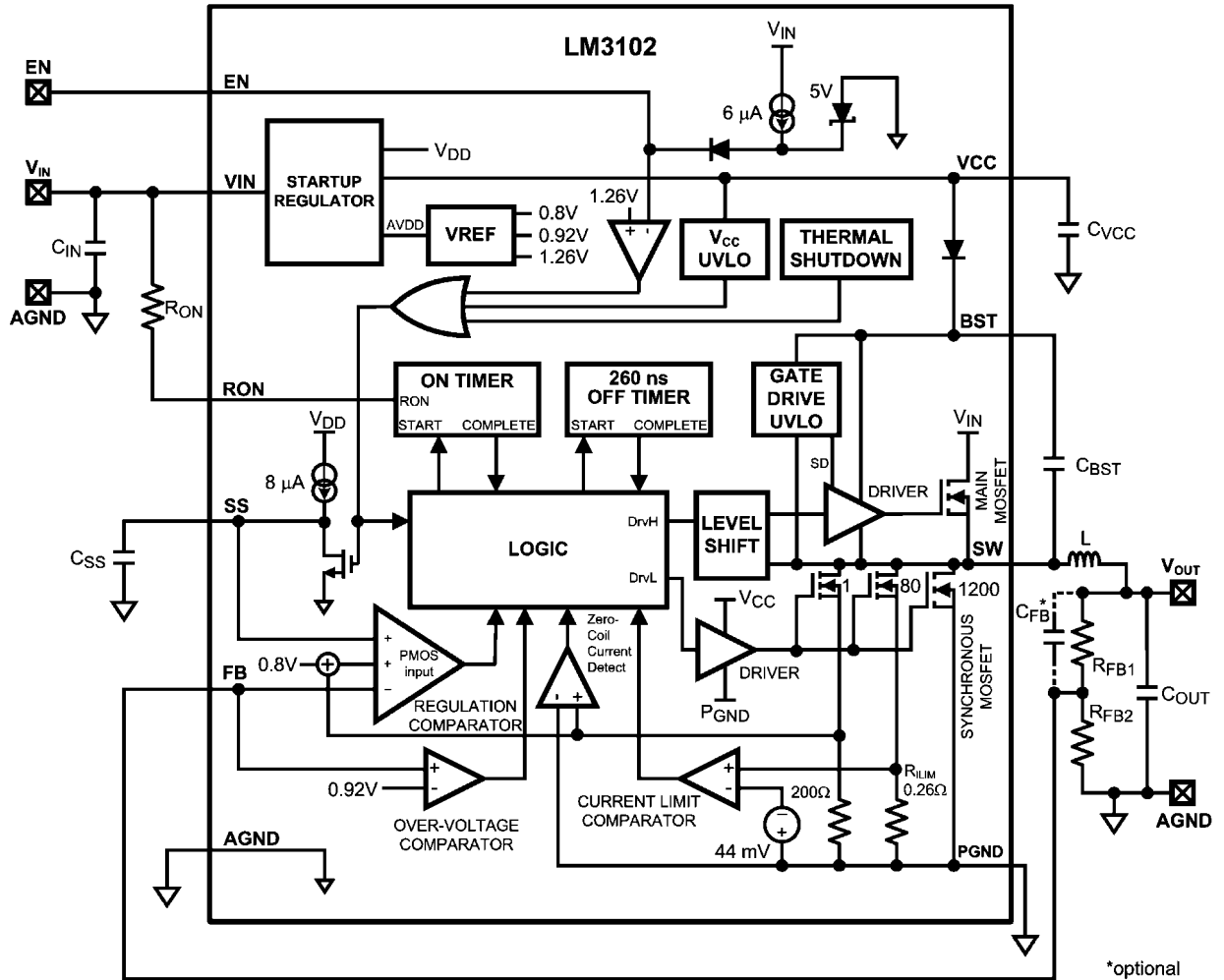

*optional
30021320

Functional Description

The LM3102 Step Down Switching Regulator features all required functions to implement a cost effective, efficient buck power converter capable of supplying 2.5A to a load. It contains Dual N-Channel main and synchronous MOSFETs. The Constant ON-Time (COT) regulation scheme requires no loop compensation, results in fast load transient response and simple circuit implementation. The regulator can function properly even with an all ceramic output capacitor network, and does not rely on the output capacitor's ESR for stability. The operating frequency remains constant with line variations due to the inverse relationship between the input voltage and the on-time. The valley current limit detection circuit, with the limit set internally at 2.7A, inhibits the main MOSFET until the inductor current level subsides.

The LM3102 can be applied in numerous applications and can operate efficiently for inputs as high as 42V. Protection features include output over-voltage protection, thermal shut-down, V_{CC} under-voltage lock-out, gate drive under-voltage lock-out. The LM3102 is available in the thermally enhanced eTSSOP-20 package.

COT Control Circuit Overview

COT control is based on a comparator and a one-shot on-timer, with the output voltage feedback (feeding to the FB pin) compared with an internal reference of 0.8V. If the voltage of the FB pin is below the reference, the main MOSFET is turned on for a fixed on-time determined by a programming resistor R_{ON} and the input voltage V_{IN} , upon which the on-time varies inversely. Following the on-time, the main MOSFET remains off for a minimum of 260 ns. Then, if the voltage of the FB pin is below the reference, the main MOSFET is turned on again for another on-time period. The switching will continue to achieve regulation.

The regulator will operate in the discontinuous conduction mode (DCM) at a light load, and the continuous conduction mode (CCM) with a heavy load. In the DCM, the current through the inductor starts at zero and ramps up to a peak during the on-time, and then ramps back to zero before the end of the off-time. It remains zero and the load current is supplied entirely by the output capacitor. The next on-time period starts when the voltage at the FB pin falls below the internal reference. The operating frequency in the DCM is lower and varies larger with the load current as compared with the CCM. Conversion efficiency is maintained since conduction loss and switching loss are reduced with the reduction in the load and the switching frequency respectively. The operating frequency in the DCM can be calculated approximately as follows:

$$f_{sw} = \frac{V_{OUT} (V_{IN} - 1) \times L \times 1.18 \times 10^{20} \times I_{OUT}}{(V_{IN} - V_{OUT}) \times R_{ON}^2} \quad (1)$$

In the continuous conduction mode (CCM), the current flows through the inductor in the entire switching cycle, and never reaches zero during the off-time. The operating frequency remains relatively constant with load and line variations. The CCM operating frequency can be calculated approximately as follows:

$$f_{sw} = \frac{V_{OUT}}{1.3 \times 10^{-10} \times R_{ON}} \quad (2)$$

The output voltage is set by two external resistors R_{FB1} and R_{FB2} . The regulated output voltage is

$$V_{OUT} = 0.8V \times (R_{FB1} + R_{FB2})/R_{FB2} \quad (3)$$

Startup Regulator (V_{CC})

A startup regulator is integrated within the LM3102. The input pin V_{IN} can be connected directly to a line voltage up to 42V. The V_{CC} output regulates at 6V, and is current limited to 65 mA. Upon power up, the regulator sources current into an external capacitor C_{VCC} , which is connected to the VCC pin. For stability, C_{VCC} must be at least 680 nF. When the voltage on the VCC pin is higher than the under-voltage lock-out (UVLO) threshold of 3.75V, the main MOSFET is enabled and the SS pin is released to allow the soft-start capacitor C_{SS} to charge. The minimum input voltage is determined by the dropout voltage of the regulator and the V_{CC} UVLO falling threshold ($\approx 3.7V$). If V_{IN} is less than $\approx 4.0V$, the regulator shuts off and V_{CC} goes to zero.

Regulation Comparator

The feedback voltage at the FB pin is compared to a 0.8V internal reference. In normal operation (the output voltage is regulated), an on-time period is initiated when the voltage at the FB pin falls below 0.8V. The main MOSFET stays on for the on-time, causing the output voltage and consequently the voltage of the FB pin to rise above 0.8V. After the on-time period, the main MOSFET stays off until the voltage of the FB pin falls below 0.8V again. Bias current at the FB pin is nominally 5 nA.

Zero Coil Current Detect

The current of the synchronous MOSFET is monitored by a zero coil current detection circuit which inhibits the synchronous MOSFET when its current reaches zero until the next on-time. This circuit enables the DCM operation, which improves the efficiency at a light load.

Over-Voltage Comparator

The voltage at the FB pin is compared to a 0.92V internal reference. If it rises above 0.92V, the on-time is immediately terminated. This condition is known as over-voltage protection (OVP). It can occur if the input voltage or the output load changes suddenly. Once the OVP is activated, the main MOSFET remains off until the voltage at the FB pin falls below 0.92V. The synchronous MOSFET will stay on to discharge the inductor until the inductor current reduces to zero, and then switch off.

ON-Time Timer, Shutdown

The on-time of the LM3102 main MOSFET is determined by the resistor R_{ON} and the input voltage V_{IN} . It is calculated as follows:

$$t_{on} = \frac{1.3 \times 10^{-10} \times R_{ON}}{V_{IN}} \quad (4)$$

The inverse relationship of t_{on} and V_{IN} gives a nearly constant frequency as V_{IN} is varied. R_{ON} should be selected such that the on-time at maximum V_{IN} is greater than 150 ns. The on-timer has a limiter to ensure a minimum of 150 ns for t_{on} . This limits the maximum operating frequency, which is governed by the following equation:

$$f_{SW(MAX)} = \frac{V_{OUT}}{V_{IN(MAX)} \times 150 \text{ ns}} \quad (5)$$

The LM3102 can be remotely shutdown by pulling the voltage of the EN pin below 1V. In this shutdown mode, the SS pin is internally grounded, the on-timer is disabled, and bias currents are reduced. Releasing the EN pin allows normal operation to resume because the EN pin is internally pulled up.

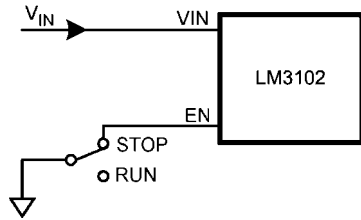

30021325

FIGURE 1. Shutdown Implementation

Current Limit

Current limit detection is carried out during the off-time by monitoring the re-circulating current through the synchronous MOSFET. Referring to the Functional Block Diagram, when

the main MOSFET is turned off, the inductor current flows through the load, the PGND pin and the internal synchronous MOSFET. If this current exceeds 2.7A, the current limit comparator toggles, and as a result disabling the start of the next on-time period. The next switching cycle starts when the re-circulating current falls back below 2.7A (and the voltage at the FB pin is below 0.8V). The inductor current is monitored during the on-time of the synchronous MOSFET. As long as the inductor current exceeds 2.7A, the main MOSFET will remain inhibited to achieve current limit. The operating frequency is lower during current limit due to a longer off-time.

Figure 2 illustrates an inductor current waveform. On average, the output current I_{OUT} is the same as the inductor current I_L , which is the average of the rippled inductor current. In case of current limit (the current limit portion of Figure 2), the next on-time will not initiate until that the current drops below 2.7A (assume the voltage at the FB pin is lower than 0.8V). During each on-time the current ramps up an amount equal to:

$$I_{LR} = \frac{(V_{IN} - V_{OUT}) \times t_{on}}{L} \quad (6)$$

During current limit, the LM3102 operates in a constant current mode with an average output current $I_{OUT(CL)}$ equal to $2.7A + I_{LR} / 2$.

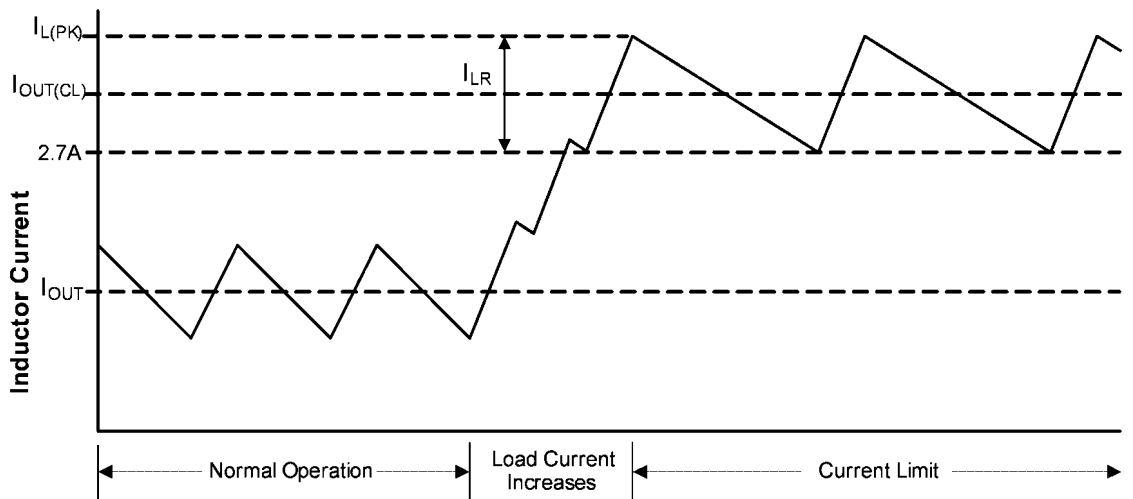

30021326

FIGURE 2. Inductor Current - Current Limit Operation

N-Channel MOSFET and Driver

The LM3102 integrates an N-Channel main MOSFET and an associated floating high voltage main MOSFET gate driver. The gate drive circuit works in conjunction with an external bootstrap capacitor C_{BST} and an internal high voltage diode. C_{BST} connecting between the BST and SW pins powers the main MOSFET gate driver during the main MOSFET on-time. During each off-time, the voltage of the SW pin falls to approximately -1V, and C_{BST} charges from V_{CC} through the internal diode. The minimum off-time of 260 ns provides enough time for charging C_{BST} in each cycle.

Soft-Start

The soft-start feature allows the converter to gradually reach a steady state operating point, thereby reducing startup stresses and current surges. Upon turn-on, after V_{CC} reaches the under-voltage threshold, an 8 μ A internal current source charges up an external capacitor C_{SS} connecting to the SS pin. The ramping voltage at the SS pin (and the non-inverting input of the regulation comparator as well) ramps up the output voltage V_{OUT} in a controlled manner.

An internal switch grounds the SS pin if any of the following three cases happens: (i) V_{CC} is below the under-voltage lock-out threshold; (ii) a thermal shutdown occurs; or (iii) the EN pin is grounded. Alternatively, the output voltage can be shut off by connecting the SS pin to ground using an external switch. Releasing the switch allows the SS pin to ramp up and the output voltage to return to normal. The shutdown configuration is shown in Figure 3.

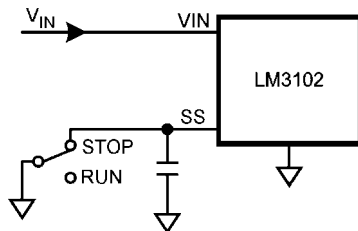

30021327

FIGURE 3. Alternate Shutdown Implementation

Thermal Protection

The junction temperature of the LM3102 should not exceed the maximum limit. Thermal protection is implemented by an internal Thermal Shutdown circuit, which activates (typically) at 165°C to make the controller enter a low power reset state by disabling the main MOSFET, disabling the on-timer, and grounding the SS pin. Thermal protection helps prevent catastrophic failures from accidental device overheating. When the junction temperature falls back below 145°C (typical hysteresis = 20°C), the SS pin is released and normal operation resumes.

Thermal Derating

The LM3102 is capable of supplying 2.5A below an ambient temperature of 100°C. Under worst case operation, with either input voltage up to 42V, operating frequency up to 1 MHz, or voltage of the RON pin below the absolute maximum of 7V, the LM3102 can deliver a minimum of 1.9A output current without thermal shutdown with a PCB ground plane copper area of 40cm², 2 oz/Cu. Figure 4 shows a thermal derating curve for the minimum output current without thermal shut-

down against ambient temperature up to 125°C. Obtaining 2.5A output current is possible by increasing the PCB ground plane area, or reducing the input voltage or operating frequency.

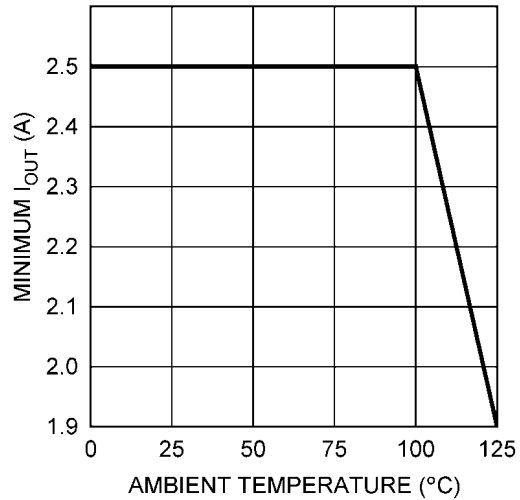

30021340

FIGURE 4. Thermal Derating Curve

Applications Information

EXTERNAL COMPONENTS

The following guidelines can be used to select external components.

R_{FB1} and R_{FB2}: These resistors should be chosen from standard values in the range of 1.0 kΩ to 10 kΩ, satisfying the following ratio:

$$R_{FB1}/R_{FB2} = (V_{OUT}/0.8V) - 1 \quad (7)$$

For $V_{OUT} = 0.8V$, the FB pin can be connected to the output directly with a pre-load resistor drawing more than 20 μA. It is because the converter operation needs a minimum inductor current ripple to maintain good regulation when no load is connected.

R_{ON}: Equation (2) can be used to select R_{ON} if a desired operating frequency is selected. But the minimum value of R_{ON} is determined by the minimum on-time. It can be calculated as follows:

$$R_{ON} \geq \frac{V_{IN(MAX)} \times 150 \text{ ns}}{1.3 \times 10^{-10}} \quad (8)$$

If R_{ON} calculated from (2) is smaller than the minimum value determined in (8), a lower frequency should be selected to recalculate R_{ON} by (2). Alternatively, V_{IN(MAX)} can also be limited in order to keep the frequency unchanged. The relationship of V_{IN(MAX)} and R_{ON} is shown in [Figure 5](#).

On the other hand, the minimum off-time of 260 ns can limit the maximum duty ratio. Larger R_{ON} should be selected in any application requiring large duty ratio.

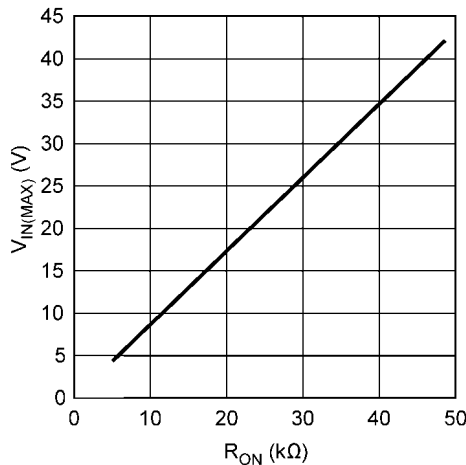

30021329

FIGURE 5. Maximum V_{IN} for selected R_{ON}

L: The main parameter affected by the inductor is the amplitude of inductor current ripple (I_{LR}). Once I_{LR} is selected, L can be determined by:

$$L = \frac{V_{OUT} \times (V_{IN} - V_{OUT})}{I_{LR} \times f_{SW} \times V_{IN}} \quad (9)$$

where V_{IN} is the maximum input voltage and f_{SW} is determined from (2).

If the output current I_{OUT} is determined, by assuming that I_{OUT} = I_L, the higher and lower peak of I_{LR} can be determined.

Beware that the higher peak of I_{LR} should not be larger than the saturation current of the inductor and current limits of the main and synchronous MOSFETs. Also, the lower peak of I_{LR} must be positive if CCM operation is required.

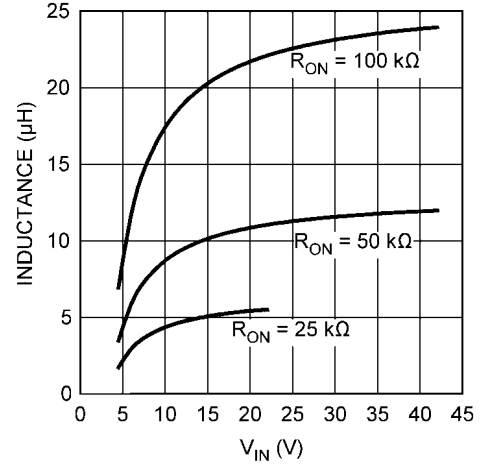

30021331

FIGURE 6. Inductor selection for V_{OUT} = 3.3V

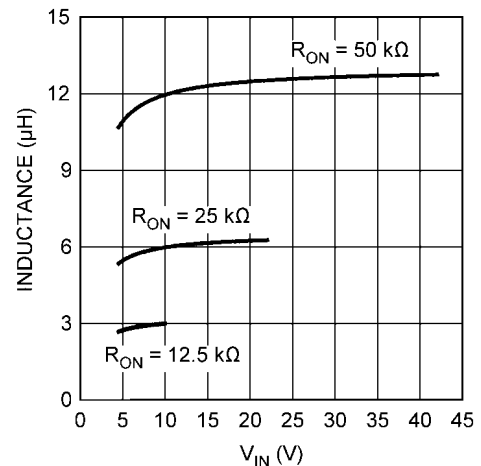

30021332

FIGURE 7. Inductor selection for V_{OUT} = 0.8V

[Figure 6](#) and [Figure 7](#) show curves on inductor selection for various V_{OUT} and R_{ON}. For small R_{ON}, according to (8), V_{IN} is limited. Some curves are therefore limited as shown in the figures.

C_{VCC}: The capacitor on the V_{CC} output provides not only noise filtering and stability, but also prevents false triggering of the V_{CC} UVLO at the main MOSFET on/off transitions. C_{VCC} should be no smaller than 680 nF for stability, and should be a good quality, low ESR, ceramic capacitor.

C_{OUT} and C_{OUT3}: C_{OUT} should generally be no smaller than 10 μF. Experimentation is usually necessary to determine the minimum value for C_{OUT}, as the nature of the load may require a larger value. A load which creates significant transients requires a larger C_{OUT} than a fixed load.

C_{OUT3} is a small value ceramic capacitor located close to the LM3102 to further suppress high frequency noise at V_{OUT}. A 100 nF capacitor is recommended.

C_{IN} and C_{IN3} : The function of C_{IN} is to supply most of the main MOSFET current during the on-time, and limit the voltage ripple at the VIN pin, assuming that the voltage source connecting to the VIN pin has finite output impedance. If the voltage source's dynamic impedance is high (effectively a current source), C_{IN} supplies the average input current, but not the ripple current.

At the maximum load current, when the main MOSFET turns on, the current to the VIN pin suddenly increases from zero to the lower peak of the inductor's ripple current and ramps up to the higher peak value. It then drops to zero at turn-off. The average current during the on-time is the load current. For a worst case calculation, C_{IN} must be capable of supplying this average load current during the maximum on-time. C_{IN} is calculated from:

$$C_{IN} = \frac{I_{OUT} \times t_{on}}{\Delta V_{IN}} \quad (10)$$

where I_{OUT} is the load current, t_{on} is the maximum on-time, and ΔV_{IN} is the allowable ripple voltage at V_{IN} .

C_{IN3} 's purpose is to help avoid transients and ringing due to long lead inductance at the VIN pin. A low ESR 0.1 μF ceramic chip capacitor located close to the LM3102 is recommended.

C_{BST} : A 33 nF high quality ceramic capacitor with low ESR is recommended for C_{BST} since it supplies a surge current to charge the main MOSFET gate driver at turn-on. Low ESR also helps ensure a complete recharge during each off-time.

C_{SS} : The capacitor at the SS pin determines the soft-start time, i.e. the time for the reference voltage at the regulation comparator and the output voltage to reach their final value. The time is determined from the following equation:

$$t_{SS} = \frac{C_{SS} \times 0.8V}{8 \mu\text{A}} \quad (11)$$

C_{FB} : If the output voltage is higher than 1.6V, C_{FB} is needed in the Discontinuous Conduction Mode to reduce the output ripple. The recommended value for C_{FB} is 10 nF.

PC BOARD LAYOUT

The LM3102 regulation, over-voltage, and current limit comparators are very fast so they will respond to short duration noise pulses. Layout is therefore critical for optimum performance. It must be as neat and compact as possible, and all external components must be as close to their associated pins of the LM3102 as possible. Refer to the functional block diagram, the loop formed by C_{IN} , the main and synchronous MOSFET internal to the LM3102, and the PGND pin should be as small as possible. The connection from the PGND pin to C_{IN} should be as short and direct as possible. Vias should be added to connect the ground of C_{IN} to a ground plane, located as close to the capacitor as possible. The bootstrap capacitor C_{BST} should be connected as close to the SW and BST pins as possible, and the connecting traces should be thick. The feedback resistors and capacitor R_{FB1} , R_{FB2} , and C_{FB} should be close to the FB pin. A long trace running from V_{OUT} to R_{FB1} is generally acceptable since this is a low impedance node. Ground R_{FB2} directly to the AGND pin (pin 7). The output capacitor C_{OUT} should be connected close to the load and tied directly to the ground plane. The inductor L should be connected close to the SW pin with as short a trace as possible to reduce the potential for EMI (electromagnetic interference) generation. If it is expected that the internal dissipation of the LM3102 will produce excessive junction temperature during normal operation, making good use of the PC board's ground plane can help considerably to dissipate heat. The exposed pad on the bottom of the LM3102 IC package can be soldered to the ground plane, which should extend out from beneath the LM3102 to help dissipate heat. The exposed pad is internally connected to the LM3102 IC substrate. Additionally the use of thick traces, where possible, can help conduct heat away from the LM3102. Using numerous vias to connect the die attached pad to the ground plane is a good practice. Judicious positioning of the PC board within the end product, along with the use of any available air flow (forced or natural convection) can help reduce the junction temperature.

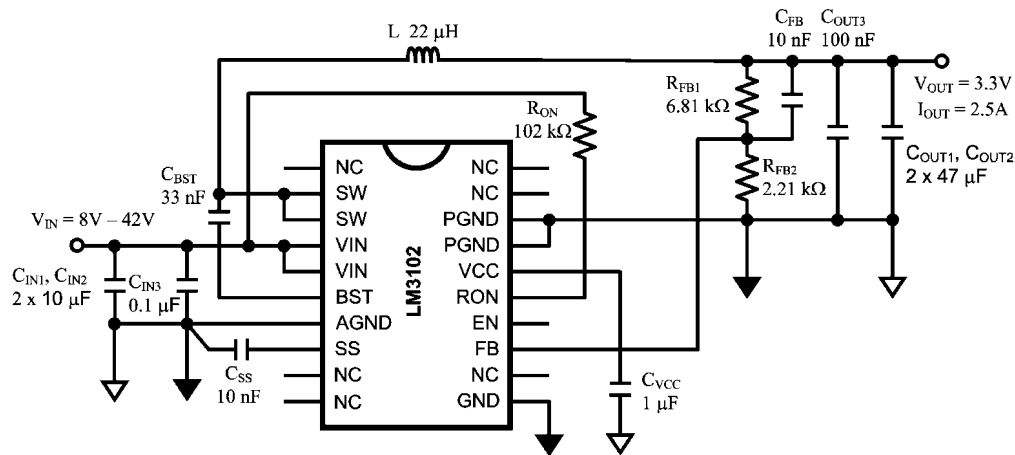

Typical Application Schematic for $V_{OUT} = 3.3V$

30021335

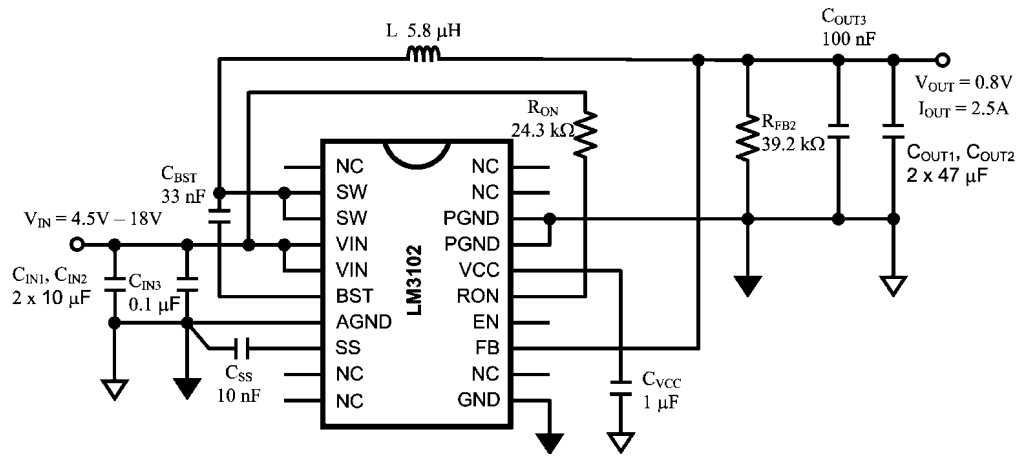

Typical Application Schematic for $V_{OUT} = 0.8V$

30021336

PACKAGE DIMENSIONS					
X1 DESIGNATOR	X1 PACKAGE WIDTH $\pm 30\mu\text{m}$	X2 DESIGNATOR	X2 PACKAGE LENGTH $\pm 30\mu\text{m}$	X3 DESIGNATOR	X3 PACKAGE HEIGHT $\pm 75\mu\text{m}$
A	1965	Z	3465	A	600
B	1990	1	3490		
C	2016	A	3516		
D	2041	B	3541		
E	2067	C	3567		
F	2092	D	3592		
G	2118	E	3618		
H	2143	F	3643		
J	2169	G	3669		
K	2194	H	3694		
L	2220	J	3720		
M	2245	K	3745		
N	2271	L	3771		
P	2296	M	3796		
Q	2322	N	3822		
R	2347	P	3847		
S	2373	Q	3873		
T	2398	R	3898		
U	2424	S	3924		
V	2449	T	3949		

Table 1 TLC28XXX dimensions

30021356

Physical Dimensions inches (millimeters) unless otherwise noted

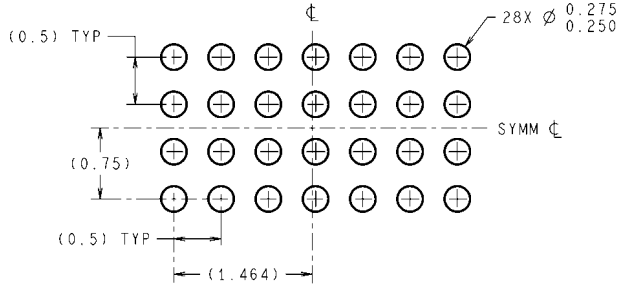

LAND PATTERN RECOMMENDATION

DIMENSIONS ARE IN MILLIMETERS
DIMENSIONS IN () FOR REFERENCE ONLY

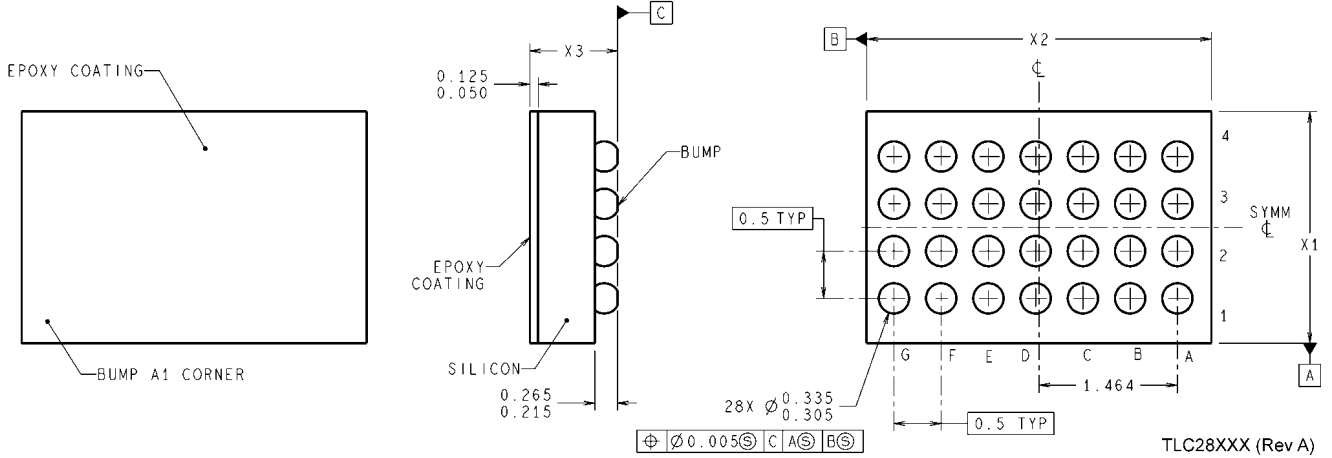

TLC28XXX (Rev A)

28-Ball μ SMD
NS Package Number TLC28VFA
See Table 1 for VFA dimensions

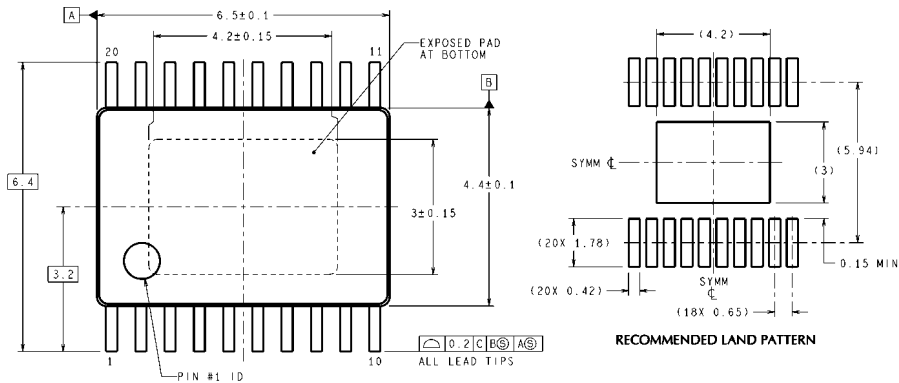

RECOMMENDED LAND PATTERN

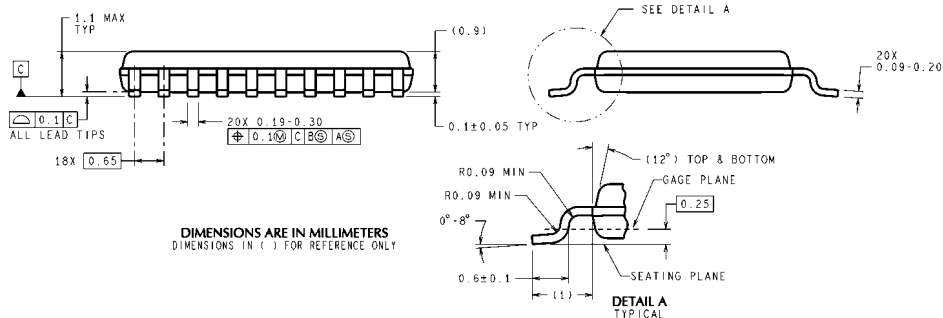

DIMENSIONS ARE IN MILLIMETERS
DIMENSIONS IN () FOR REFERENCE ONLY

20-Lead Plastic eTSSOP Package
NS Package Number MXA20A

MXA20A (Rev C)

Notes

LM3102

Notes

For more National Semiconductor product information and proven design tools, visit the following Web sites at:
www.national.com

Products		Design Support	
Amplifiers	www.national.com/amplifiers	WEBENCH® Tools	www.national.com/webench
Audio	www.national.com/audio	App Notes	www.national.com/appnotes
Clock and Timing	www.national.com/timing	Reference Designs	www.national.com/refdesigns
Data Converters	www.national.com/adc	Samples	www.national.com/samples
Interface	www.national.com/interface	Eval Boards	www.national.com/evalboards
LVDS	www.national.com/lvds	Packaging	www.national.com/packaging
Power Management	www.national.com/power	Green Compliance	www.national.com/quality/green
Switching Regulators	www.national.com/switchers	Distributors	www.national.com/contacts
LDOs	www.national.com/lido	Quality and Reliability	www.national.com/quality
LED Lighting	www.national.com/led	Feedback/Support	www.national.com/feedback
Voltage References	www.national.com/vref	Design Made Easy	www.national.com/easy
PowerWise® Solutions	www.national.com/powerwise	Applications & Markets	www.national.com/solutions
Serial Digital Interface (SDI)	www.national.com/sdi	Mil/Aero	www.national.com/milaero
Temperature Sensors	www.national.com/tempensors	SolarMagic™	www.national.com/solarmagic
PLL/VCO	www.national.com/wireless	PowerWise® Design University	www.national.com/training

THE CONTENTS OF THIS DOCUMENT ARE PROVIDED IN CONNECTION WITH NATIONAL SEMICONDUCTOR CORPORATION ("NATIONAL") PRODUCTS. NATIONAL MAKES NO REPRESENTATIONS OR WARRANTIES WITH RESPECT TO THE ACCURACY OR COMPLETENESS OF THE CONTENTS OF THIS PUBLICATION AND RESERVES THE RIGHT TO MAKE CHANGES TO SPECIFICATIONS AND PRODUCT DESCRIPTIONS AT ANY TIME WITHOUT NOTICE. NO LICENSE, WHETHER EXPRESS, IMPLIED, ARISING BY ESTOPPEL OR OTHERWISE, TO ANY INTELLECTUAL PROPERTY RIGHTS IS GRANTED BY THIS DOCUMENT.

TESTING AND OTHER QUALITY CONTROLS ARE USED TO THE EXTENT NATIONAL DEEMS NECESSARY TO SUPPORT NATIONAL'S PRODUCT WARRANTY. EXCEPT WHERE MANDATED BY GOVERNMENT REQUIREMENTS, TESTING OF ALL PARAMETERS OF EACH PRODUCT IS NOT NECESSARILY PERFORMED. NATIONAL ASSUMES NO LIABILITY FOR APPLICATIONS ASSISTANCE OR BUYER PRODUCT DESIGN. BUYERS ARE RESPONSIBLE FOR THEIR PRODUCTS AND APPLICATIONS USING NATIONAL COMPONENTS. PRIOR TO USING OR DISTRIBUTING ANY PRODUCTS THAT INCLUDE NATIONAL COMPONENTS, BUYERS SHOULD PROVIDE ADEQUATE DESIGN, TESTING AND OPERATING SAFEGUARDS.

EXCEPT AS PROVIDED IN NATIONAL'S TERMS AND CONDITIONS OF SALE FOR SUCH PRODUCTS, NATIONAL ASSUMES NO LIABILITY WHATSOEVER, AND NATIONAL DISCLAIMS ANY EXPRESS OR IMPLIED WARRANTY RELATING TO THE SALE AND/OR USE OF NATIONAL PRODUCTS INCLUDING LIABILITY OR WARRANTIES RELATING TO FITNESS FOR A PARTICULAR PURPOSE, MERCHANTABILITY, OR INFRINGEMENT OF ANY PATENT, COPYRIGHT OR OTHER INTELLECTUAL PROPERTY RIGHT.

LIFE SUPPORT POLICY

NATIONAL'S PRODUCTS ARE NOT AUTHORIZED FOR USE AS CRITICAL COMPONENTS IN LIFE SUPPORT DEVICES OR SYSTEMS WITHOUT THE EXPRESS PRIOR WRITTEN APPROVAL OF THE CHIEF EXECUTIVE OFFICER AND GENERAL COUNSEL OF NATIONAL SEMICONDUCTOR CORPORATION. As used herein:

Life support devices or systems are devices which (a) are intended for surgical implant into the body, or (b) support or sustain life and whose failure to perform when properly used in accordance with instructions for use provided in the labeling can be reasonably expected to result in a significant injury to the user. A critical component is any component in a life support device or system whose failure to perform can be reasonably expected to cause the failure of the life support device or system or to affect its safety or effectiveness.

National Semiconductor and the National Semiconductor logo are registered trademarks of National Semiconductor Corporation. All other brand or product names may be trademarks or registered trademarks of their respective holders.

Copyright© 2010 National Semiconductor Corporation

For the most current product information visit us at www.national.com



**National Semiconductor
Americas Technical
Support Center**
Email: support@nsc.com
Tel: 1-800-272-9959

**National Semiconductor Europe
Technical Support Center**
Email: europe.support@nsc.com

**National Semiconductor Asia
Pacific Technical Support Center**
Email: ap.support@nsc.com

**National Semiconductor Japan
Technical Support Center**
Email: jpn.feedback@nsc.com