

# LM27313

## 1.6 MHz Boost Converter With 30V Internal FET Switch in SOT-23

### General Description

The LM27313 switching regulator is a current-mode boost converter with a fixed operating frequency of 1.6 MHz.

The use of the SOT-23 package, made possible by the minimal losses of the 800 mA switch, and small inductors and capacitors result in extremely high power density. The 30V internal switch makes these solutions perfect for boosting to voltages of 5V to 28V.

This part has a logic-level shutdown pin that can be used to reduce quiescent current and extend battery life.

Protection is provided through cycle-by-cycle current limiting and thermal shutdown. Internal compensation simplifies design and reduces component count.

### Features

- 30V DMOS FET switch
- 1.6 MHz switching frequency
- Low  $R_{DS(ON)}$  DMOS FET
- Switch current up to 800 mA
- Wide input voltage range (2.7V–14V)
- Low shutdown current (<1  $\mu$ A)
- 5-Lead SOT-23 package
- Uses tiny capacitors and inductors
- Cycle-by-cycle current limiting
- Internally compensated

### Applications

- White LED Current Source
- PDA's and Palm-Top Computers
- Digital Cameras
- Portable Phones, Games and Media Players
- GPS Devices

### Typical Application Circuits

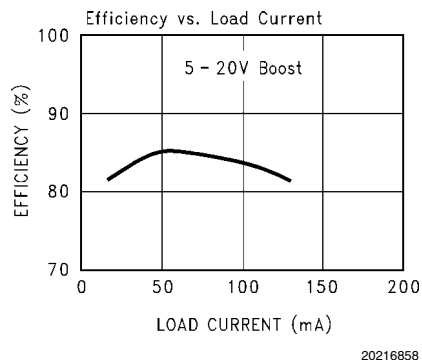
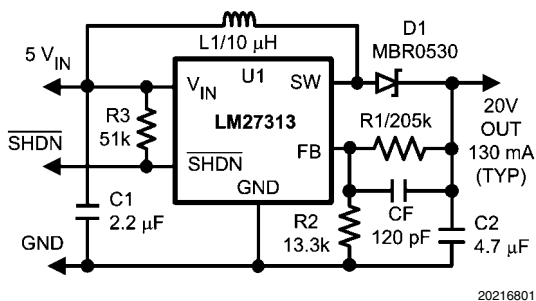
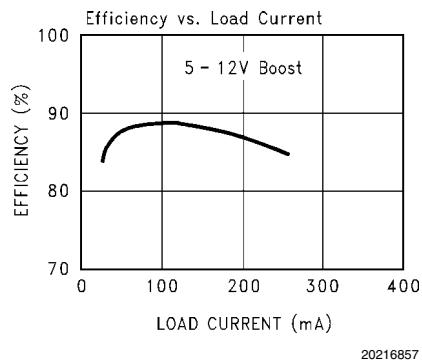
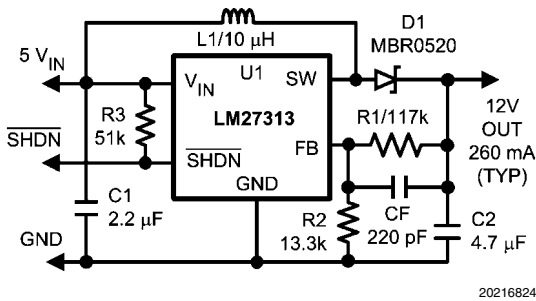

## Connection Diagram

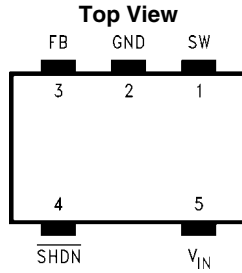

20216802  
**5-Lead SOT-23 Package**  
 See NS Package Number MF05A

## Ordering Information

Order Number	Package Type	Package Drawing	Supplied As	Package Marking
LM27313XMF	SOT23-5	MF05A	1K Tape and Reel	SRPB
LM27313XMF <sub>X</sub>			3K Tape and Reel	SRPB

## Pin Descriptions

Pin	Name	Function
1	SW	Drain of the internal FET switch.
2	GND	Analog and power ground.
3	FB	Feedback point that connects to external resistive divider to set $V_{OUT}$ .
4	$\overline{\text{SHDN}}$	Shutdown control input. Connect to $V_{IN}$ if this feature is not used.
5	$V_{IN}$	Analog and power input.

**Absolute Maximum Ratings** (Note 1)

If Military/Aerospace specified devices are required, please contact the National Semiconductor Sales Office/Distributors for availability and specifications.

Storage Temperature Range	-65°C to +150°C
Lead Temp. (Soldering, 5 sec.)	300°C
Power Dissipation (Note 2)	Internally Limited
FB Pin Voltage	-0.4V to +6V
SW Pin Voltage	-0.4V to +30V
Input Supply Voltage	-0.4V to +14.5V

Shutdown Input Voltage (Survival)	-0.4V to +14.5V
ESD Rating (Note 3) Human Body Model	±2 kV

**Operating Ratings**

$V_{IN}$	2.7V to 14V
$V_{SW(MAX)}$	30V
$V_{SHDN}$	0V to $V_{IN}$
Junction Temperature, $T_J$ (Note 2)	-40°C to 125°C
$\theta_{J-A}$ (SOT23-5)	265°C/W

**Electrical Characteristics**

Unless otherwise specified:  $V_{IN} = 5V$ ,  $V_{SHDN} = 5V$ ,  $I_L = 0$  mA, and  $T_J = 25^\circ C$ . Limits in standard typeface are for  $T_J = 25^\circ C$ , and limits in **boldface type** apply over the full operating temperature range ( $-40^\circ C \leq T_J \leq +125^\circ C$ ). Minimum and Maximum limits are guaranteed through test, design, or statistical correlation. Typical values represent the most likely parametric norm at  $T_J = 25^\circ C$ , and are provided for reference purposes only.

Symbol	Parameter	Conditions	Min	Typical	Max	Units
$V_{IN}$	Input Voltage		<b>2.7</b>		<b>14</b>	V
$I_{SW}$	Switch Current Limit	(Note 4)	0.80	1.25		A
$R_{DS(ON)}$	Switch ON Resistance	$I_{SW} = 100$ mA		500	650	m $\Omega$
$V_{SHDN(TH)}$	Shutdown Threshold	Device ON	<b>1.5</b>			V
		Device OFF			<b>0.50</b>	
$I_{SHDN}$	Shutdown Pin Bias Current	$V_{SHDN} = 0$		0		$\mu$ A
		$V_{SHDN} = 5V$		0	<b>2</b>	
$V_{FB}$	Feedback Pin Reference Voltage	$V_{IN} = 3V$	<b>1.205</b>	1.230	<b>1.255</b>	V
$I_{FB}$	Feedback Pin Bias Current	$V_{FB} = 1.23V$		60		nA
$I_Q$	Quiescent Current	$V_{SHDN} = 5V$ , Switching		2.1	<b>3.0</b>	mA
		$V_{SHDN} = 5V$ , Not Switching		400	<b>500</b>	
		$V_{SHDN} = 0$		0.024	1	$\mu$ A
$\Delta V_{FB}/\Delta V_{IN}$	FB Voltage Line Regulation	$2.7V \leq V_{IN} \leq 14V$		0.02		%/V
$f_{SW}$	Switching Frequency		<b>1.15</b>	1.6	<b>1.90</b>	MHz
$D_{MAX}$	Maximum Duty Cycle		<b>80</b>	88		%
$I_L$	Switch Leakage	Not Switching, $V_{SW} = 5V$			1	$\mu$ A

**Note 1:** Absolute Maximum Ratings indicate limits beyond which damage to the device may occur. Operating Ratings indicate conditions for which the device is to be functional, but does not guarantee specific limits. For guaranteed specifications and conditions see the Electrical Characteristic table.

**Note 2:** The maximum power dissipation which can be safely dissipated for any application is a function of the maximum junction temperature,  $T_{J(MAX)} = 125^\circ C$ , the junction-to-ambient thermal resistance for the SOT-23 package,  $\theta_{J-A} = 265^\circ C/W$ , and the ambient temperature,  $T_A$ . The maximum allowable power dissipation at any ambient temperature for designs using this device can be calculated using the formula:

$$P (MAX) = \frac{T_J (MAX) - T_A}{\theta_{J-A}} = \frac{125 - T_A}{265}$$

If power dissipation exceeds the maximum specified above, the internal thermal protection circuitry will protect the device by reducing the output voltage as required to maintain a safe junction temperature.

**Note 3:** The human body model is a 100 pF capacitor discharged through a 1.5 k $\Omega$  resistor into each pin. Test method is per JESD22-A114.

**Note 4:** Switch current limit is dependent on duty cycle. Limits shown are for duty cycles  $\leq 50\%$ . See Figure 3 in *Application Information – MAXIMUM SWITCH CURRENT* section.

## Typical Performance Characteristics

$T_J = 25^\circ\text{C}$ .

Unless otherwise specified:  $V_{IN} = 5\text{V}$ , SHDN pin is tied to  $V_{IN}$ .

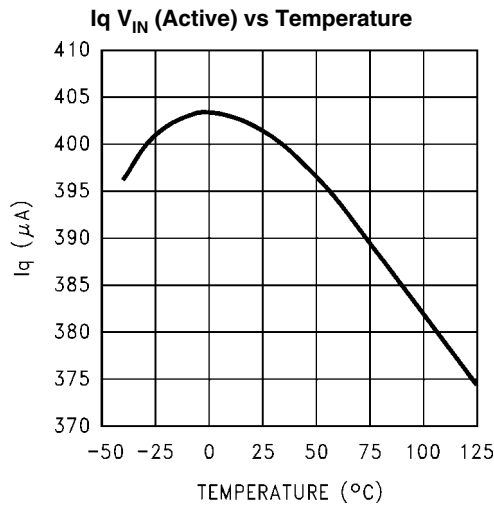

20216810

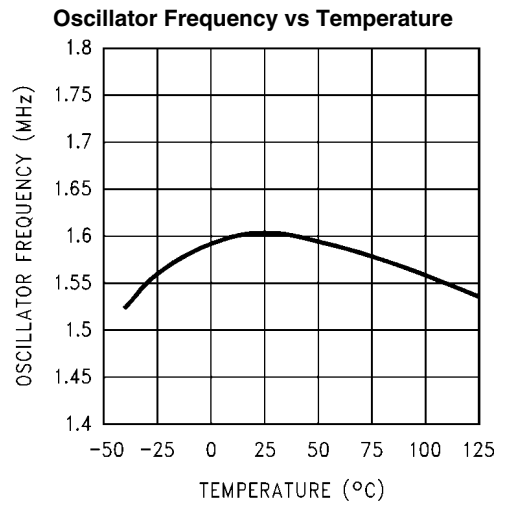

20216808

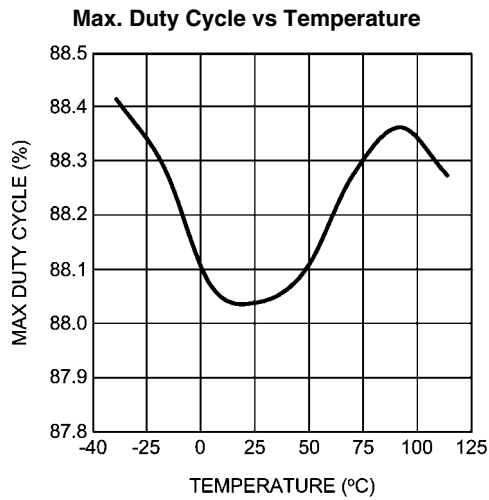

20216855

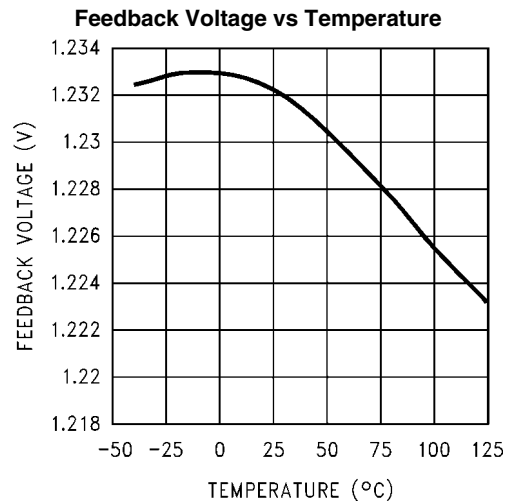

20216806

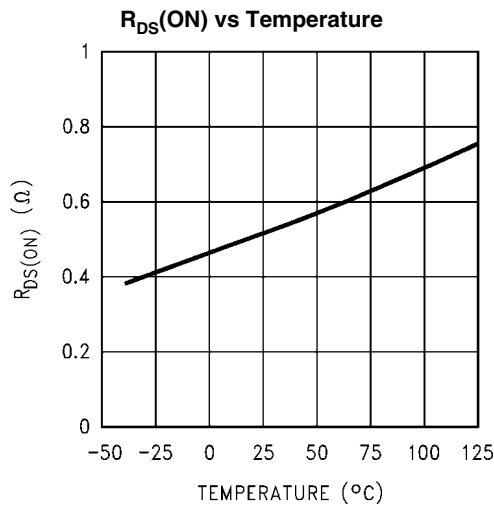

20216807

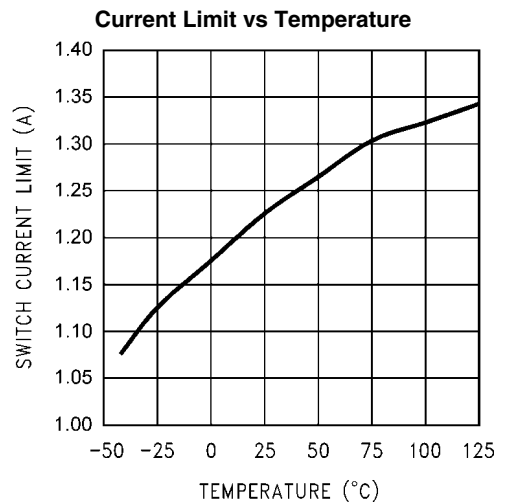

20216809

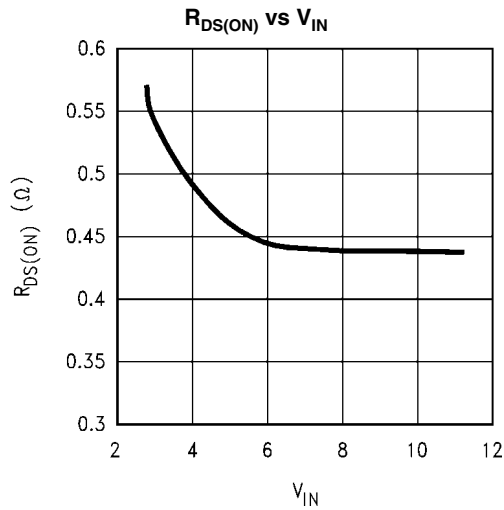

20216823

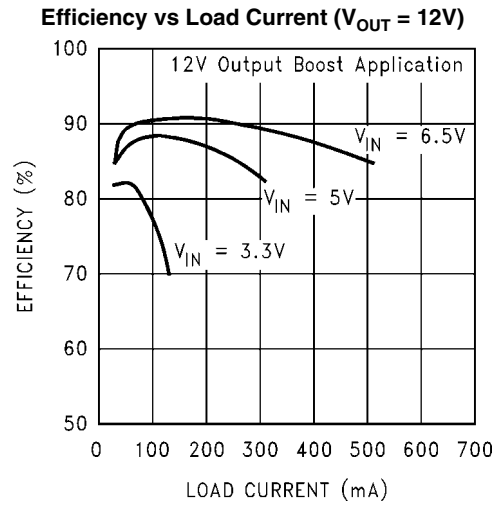

20216814

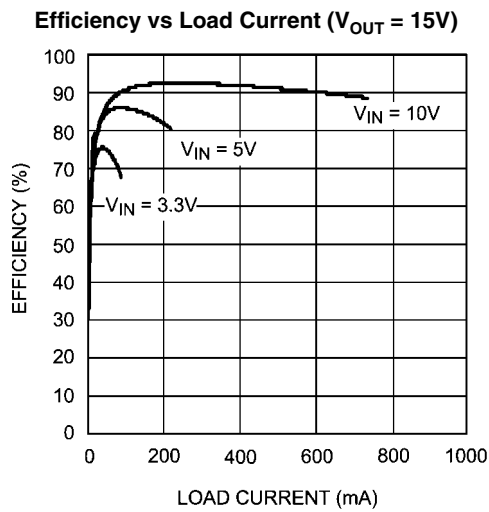

20216845

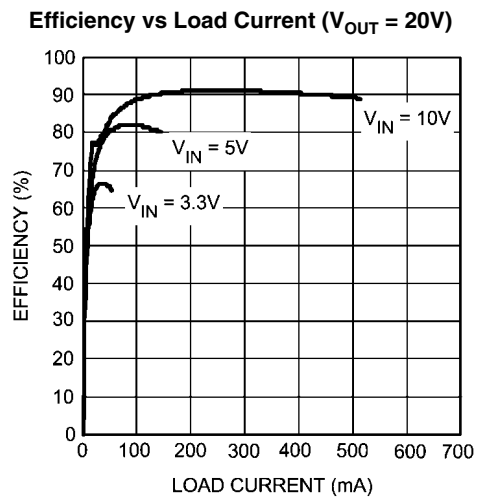

20216846

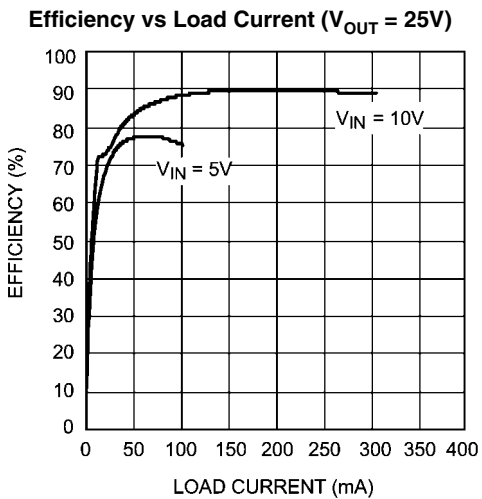

20216847

## Block Diagram

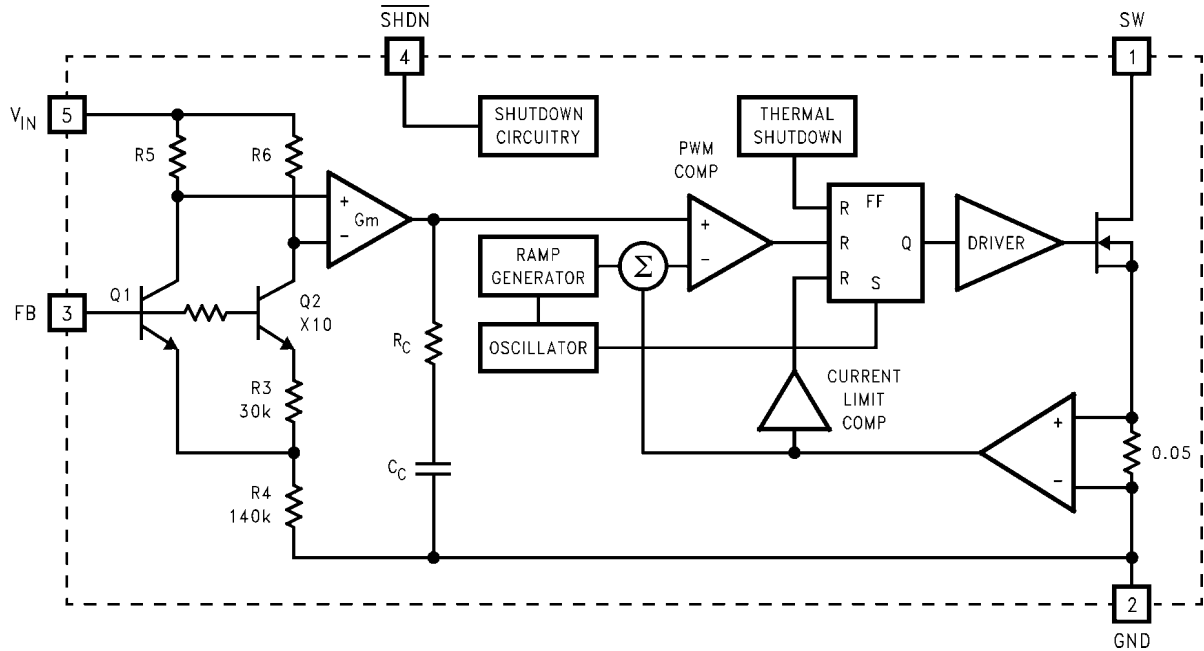

20216803

## Theory of Operation

The LM27313 is a switching converter IC that operates at a fixed frequency of 1.6 MHz using current-mode control for fast transient response over a wide input voltage range and incorporate pulse-by-pulse current limiting protection. Because this is current mode control, a 50 mΩ sense resistor in series with the switch FET is used to provide a voltage (which is proportional to the FET current) to both the input of the pulse width modulation (PWM) comparator and the current limit amplifier.

At the beginning of each cycle, the S-R latch turns on the FET. As the current through the FET increases, a voltage (proportional to this current) is summed with the ramp coming from the ramp generator and then fed into the input of the PWM comparator. When this voltage exceeds the voltage on the other input (coming from the Gm amplifier), the latch resets and turns the FET off. Since the signal coming from the Gm amplifier is derived from the feedback (which samples the voltage at the output), the action of the PWM comparator constantly sets the correct peak current through the FET to keep the output voltage in regulation.

Q1 and Q2 along with R3 - R6 form a bandgap voltage reference used by the IC to hold the output in regulation. The currents flowing through Q1 and Q2 will be equal, and the feedback loop will adjust the regulated output to maintain this. Because of this, the regulated output is always maintained at a voltage level equal to the voltage at the FB node "multiplied up" by the ratio of the output resistive divider.

The current limit comparator feeds directly into the flip-flop, that drives the switch FET. If the FET current reaches the limit threshold, the FET is turned off and the cycle terminated until the next clock pulse. The current limit input terminates the pulse regardless of the status of the output of the PWM comparator.

## Application Information

### SELECTING THE EXTERNAL CAPACITORS

The LM27313 requires ceramic capacitors at the input and output to accommodate the peak switching currents the part needs to operate. Electrolytic capacitors have resonant frequencies which are below the switching frequency of the device, and therefore can not provide the currents needed to operate. Electrolytics may be used in parallel with the ceramics for bulk charge storage which will improve transient response.

When selecting a ceramic capacitor, only X5R and X7R dielectric types should be used. Other types such as Z5U and Y5F have such severe loss of capacitance due to effects of temperature variation and applied voltage, they may provide as little as 20% of rated capacitance in many typical applications. Always consult capacitor manufacturer's data curves before selecting a capacitor. High-quality ceramic capacitors can be obtained from Taiyo-Yuden, AVX, and Murata.

### SELECTING THE OUTPUT CAPACITOR

A single ceramic capacitor of value 4.7 μF to 10 μF will provide sufficient output capacitance for most applications. For output voltages below 10V, a 10 μF capacitance is required. If larger amounts of capacitance are desired for improved line support and transient response, tantalum capacitors can be used in parallel with the ceramics. Aluminum electrolytics with ultra low ESR such as Sanyo Oscon can be used, but are usually prohibitively expensive. Typical Al electrolytic capacitors are not suitable for switching frequencies above 500 kHz due to significant ringing and temperature rise due to self-heating from ripple current. An output capacitor with excessive ESR can also reduce phase margin and cause instability.

### SELECTING THE INPUT CAPACITOR

An input capacitor is required to serve as an energy reservoir for the current which must flow into the inductor each time the switch turns ON. This capacitor must have extremely low ESR and ESL, so ceramic must be used. We recommend a nom-

inal value of 2.2  $\mu\text{F}$ , but larger values can be used. Since this capacitor reduces the amount of voltage ripple seen at the input pin, it also reduces the amount of EMI passed back along that line to other circuitry.

### FEED-FORWARD COMPENSATION

Although internally compensated, the feed-forward capacitor  $C_f$  is required for stability (see *Typical Application Circuits*). Adding this capacitor puts a zero in the loop response of the converter. Without it, the regulator loop can oscillate. The recommended frequency for the zero  $f_z$  should be approximately 8 kHz.  $C_f$  can be calculated using the formula:

$$C_f = 1 / (2 \times \pi \times R_1 \times f_z)$$

### SELECTING DIODES

The external diode used in the typical application should be a Schottky diode. If the switch voltage is less than 15V, a 20V diode such as the MBR0520 is recommended. If the switch voltage is between 15V and 25V, a 30V diode such as the MBR0530 is recommended. If the switch voltage exceeds 25V, a 40V diode such as the MBR0540 should be used.

The MBR05xx series of diodes are designed to handle a maximum average current of 500mA. For applications with load currents to 800mA, a Microsemi UPS5817 can be used.

### LAYOUT HINTS

High frequency switching regulators require very careful layout of components in order to get stable operation and low noise. All components must be as close as possible to the LM27313 device. It is recommended that a 4-layer PCB be used so that internal ground planes are available.

As an example, a recommended layout of components is shown:

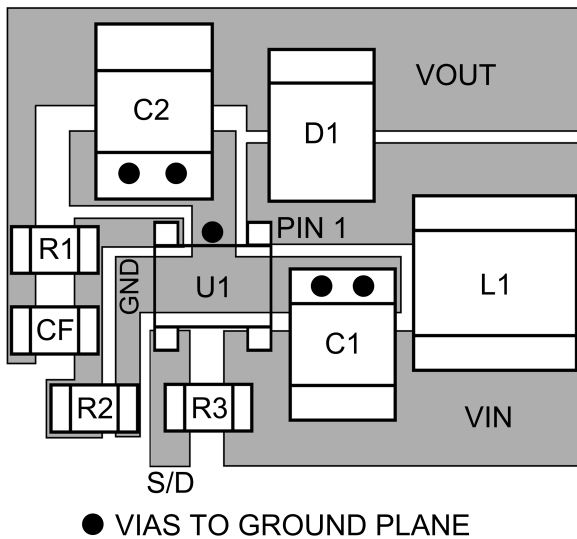

20216822

**FIGURE 1. Recommended PCB Component Layout**

Some additional guidelines to be observed:

1. Keep the path between L1, D1, and C2 extremely short. Parasitic trace inductance in series with D1 and C2 will increase noise and ringing.
2. The feedback components R1, R2 and CF must be kept close to the FB pin of the LM27313 to prevent noise injection on the high impedance FB pin.

3. If internal ground planes are available (recommended) use vias to connect directly to the LM27313 ground at device pin 2, as well as the negative sides of capacitors C1 and C2.

### SETTING THE OUTPUT VOLTAGE

The output voltage is set using the external resistors R1 and R2 (see *Typical Application Circuits*). A minimum value of 13.3 k $\Omega$  is recommended for R2 to establish a divider current of approximately 92  $\mu\text{A}$ . R1 is calculated using the formula:

$$R_1 = R_2 \times (V_{\text{OUT}} / V_{\text{FB}} - 1)$$

### DUTY CYCLE

The maximum duty cycle of the switching regulator determines the maximum boost ratio of output-to-input voltage that the converter can attain in continuous mode of operation. The duty cycle for a given boost application is defined as:

$$\text{Duty Cycle} = \frac{V_{\text{OUT}} + V_{\text{DIODE}} - V_{\text{IN}}}{V_{\text{OUT}} + V_{\text{DIODE}} - V_{\text{SW}}}$$

This applies for continuous mode operation.

The equation shown for calculating duty cycle incorporates terms for the FET switch voltage and diode forward voltage. The actual duty cycle measured in operation will also be affected slightly by other power losses in the circuit such as wire losses in the inductor, switching losses, and capacitor ripple current losses from self-heating. Therefore, the actual (effective) duty cycle measured may be slightly higher than calculated to compensate for these power losses. A good approximation for effective duty cycle is :

$$\text{DC (eff)} = (1 - \text{Efficiency} \times (V_{\text{IN}} / V_{\text{OUT}}))$$

Where the efficiency can be approximated from the curves provided.

### INDUCTANCE VALUE

The first question we are usually asked is: "How small can I make the inductor?" (because they are the largest sized component and usually the most costly). The answer is not simple and involves trade-offs in performance. More inductance means less inductor ripple current and less output voltage ripple (for a given size of output capacitor). More inductance also means more load power can be delivered because the energy stored during each switching cycle is:

$$E = L/2 \times (I_p)^2$$

Where "Ip" is the peak inductor current. An important point to observe is that the LM27313 will limit its switch current based on peak current. This means that since  $I_p(\text{max})$  is fixed, increasing L will increase the maximum amount of power available to the load. Conversely, using too little inductance may limit the amount of load current which can be drawn from the output.

Best performance is usually obtained when the converter is operated in "continuous" mode at the load current range of interest, typically giving better load regulation and less output ripple. Continuous operation is defined as not allowing the inductor current to drop to zero during the cycle. It should be noted that all boost converters shift over to discontinuous operation as the output load is reduced far enough, but a larger inductor stays "continuous" over a wider load current range.

To better understand these tradeoffs, a typical application circuit (5V to 12V boost with a 10  $\mu\text{H}$  inductor) will be analyzed.

Since the LM27313 typical switching frequency is 1.6 MHz, the typical period is equal to  $1/f_{SW(TYP)}$ , or approximately 0.625  $\mu$ s.

We will assume:  $V_{IN} = 5V$ ,  $V_{OUT} = 12V$ ,  $V_{DIODE} = 0.5V$ ,  $V_{SW} = 0.5V$ . The duty cycle is:

$$\text{Duty Cycle} = ((12V + 0.5V - 5V) / (12V + 0.5V - 0.5V)) = 62.5\%$$

The typical ON time of the switch is:

$$(62.5\% \times 0.625 \mu\text{s}) = 0.390 \mu\text{s}$$

It should be noted that when the switch is ON, the voltage across the inductor is approximately 4.5V.

Using the equation:

$$V = L (di/dt)$$

We can then calculate the di/dt rate of the inductor which is found to be 0.45 A/ $\mu$ s during the ON time. Using these facts, we can then show what the inductor current will look like during operation:

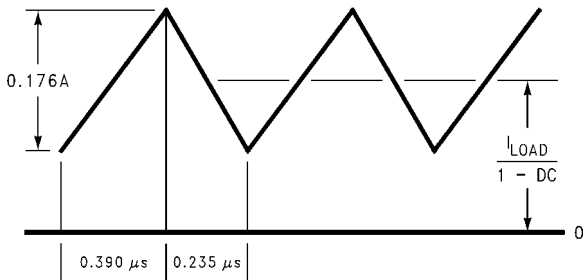

20216812

**FIGURE 2. 10  $\mu$ H Inductor Current, 5V–12V Boost**

During the 0.390  $\mu$ s ON time, the inductor current ramps up 0.176A and ramps down an equal amount during the OFF time. This is defined as the inductor "ripple current". It can also be seen that if the load current drops to about 33 mA, the inductor current will begin touching the zero axis which means it will be in discontinuous mode. A similar analysis can be performed on any boost converter, to make sure the ripple current is reasonable and continuous operation will be maintained at the typical load current values.

#### MAXIMUM SWITCH CURRENT

The maximum FET switch current available before the current limiter cuts in is dependent on duty cycle of the application. This is illustrated in *Figure 3* below which shows typical values of switch current as a function of effective (actual) duty cycle:

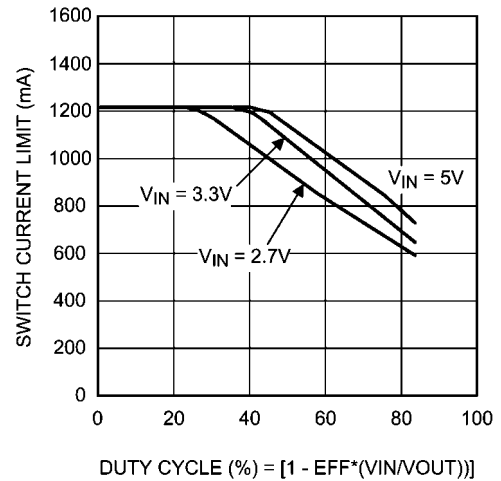

20216825

**FIGURE 3. Switch Current Limit vs Duty Cycle**

#### CALCULATING LOAD CURRENT

As shown in the figure which depicts inductor current, the load current is related to the average inductor current by the relation:

$$I_{LOAD} = I_{IND(AVG)} \times (1 - DC)$$

Where "DC" is the duty cycle of the application. The switch current can be found by:

$$I_{SW} = I_{IND(AVG)} + \frac{1}{2} (I_{RIPPLE})$$

Inductor ripple current is dependent on inductance, duty cycle, input voltage and frequency:

$$I_{RIPPLE} = DC \times (V_{IN} - V_{SW}) / (f_{SW} \times L)$$

Combining all terms, we can develop an expression which allows the maximum available load current to be calculated:

$$I_{LOAD(max)} = (1 - DC) \times (I_{SW(max)} - DC \frac{(V_{IN} - V_{SW})}{2fL})$$

The equation shown to calculate maximum load current takes into account the losses in the inductor or turn-OFF switching losses of the FET and diode. For actual load current in typical applications, we took bench data for various input and output voltages and displayed the maximum load current available for a typical device in graph form:



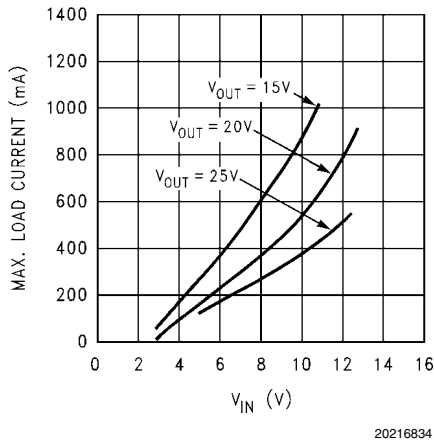

FIGURE 4. Max. Load Current vs  $V_{IN}$

### DESIGN PARAMETERS $V_{SW}$ AND $I_{SW}$

The value of the FET "ON" voltage (referred to as  $V_{SW}$  in the equations) is dependent on load current. A good approximation can be obtained by multiplying the "ON Resistance" of the FET times the average inductor current.

FET on resistance increases at  $V_{IN}$  values below 5V, since the internal N-FET has less gate voltage in this input voltage range (see Typical performance Characteristics curves). Above  $V_{IN} = 5V$ , the FET gate voltage is internally clamped to 5V.

The maximum peak switch current the device can deliver is dependent on duty cycle. The minimum switch current value ( $I_{SW}$ ) is guaranteed to be at least 800 mA at duty cycles below 50%. For higher duty cycles, see Typical performance Characteristics curves.

### THERMAL CONSIDERATIONS

At higher duty cycles, the increased ON time of the FET means the maximum output current will be determined by power dissipation within the LM27313 FET switch. The switch power dissipation from ON-state conduction is calculated by:

$$P_{SW} = DC \times I_{IND(AVG)}^2 \times R_{DS(ON)}$$

There will be some switching losses as well, so some derating needs to be applied when calculating IC power dissipation.

### MINIMUM INDUCTANCE

In some applications where the maximum load current is relatively small, it may be advantageous to use the smallest possible inductance value for cost and size savings. The converter will operate in discontinuous mode in such a case.

The minimum inductance should be selected such that the inductor (switch) current peak on each cycle does not reach the 800 mA current limit maximum. To understand how to do this, an example will be presented.

In this example, the LM27313 nominal switching frequency is 1.6 MHz, and the minimum switching frequency is 1.15 MHz. This means the maximum cycle period is the reciprocal of the minimum frequency:

$$T_{ON(max)} = 1/1.15M = 0.870 \mu s$$

We will assume:  $V_{IN} = 5V$ ,  $V_{OUT} = 12V$ ,  $V_{SW} = 0.2V$ , and  $V_{DIODE} = 0.3V$ . The duty cycle is:

$$\text{Duty Cycle} = ((12V + 0.3V - 5V) / (12V + 0.3V - 0.2V)) = 60.3\%$$

Therefore, the maximum switch ON time is:

$$(60.3\% \times 0.870 \mu s) = 0.524 \mu s$$

An inductor should be selected with enough inductance to prevent the switch current from reaching 800 mA in the 0.524  $\mu s$  ON time interval (see below):

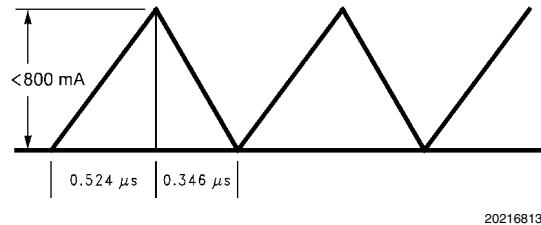

FIGURE 5. Discontinuous Design, 5V-12V Boost

The voltage across the inductor during ON time is 4.8V. Minimum inductance value is found by:

$$L = V \times (dt/dI)$$

$$L = 4.8V \times (0.524 \mu s / 0.8 \text{ mA}) = 3.144 \mu H$$

In this case, a 3.3  $\mu H$  inductor could be used, assuming it provided at least that much inductance up to the 800 mA current value. This same analysis can be used to find the minimum inductance for any boost application.

### INDUCTOR SUPPLIERS

Some of the recommended suppliers of inductors for this product include, but are not limited to, Sumida, Coilcraft, Panasonic, TDK and Murata. When selecting an inductor, make certain that the continuous current rating is high enough to avoid saturation at peak currents. A suitable core type must be used to minimize core (switching) losses, and wire power losses must be considered when selecting the current rating.

### SHUTDOWN PIN OPERATION

The device is turned off by pulling the shutdown pin low. If this function is not going to be used, the pin should be tied directly to  $V_{IN}$ . If the SHDN function will be needed, a pull-up resistor must be used to  $V_{IN}$  (50k $\Omega$  to 100 k $\Omega$  is recommended), or the pin must be actively driven high and low. The SHDN pin must not be left unterminated.

**Physical Dimensions** inches (millimeters) unless otherwise noted

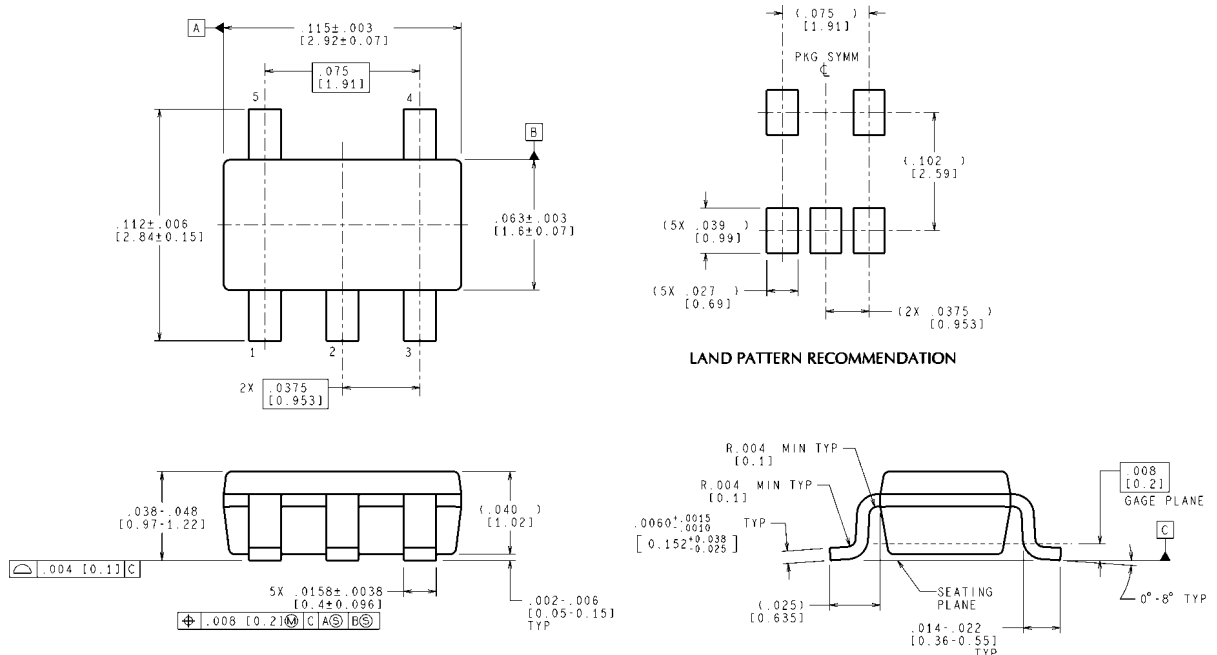

CONTROLLING DIMENSION IS INCH  
 VALUES IN [ ] ARE MILLIMETERS  
 DIMENSIONS IN ( ) FOR REFERENCE ONLY

**5-Lead SOT-23 Package**  
**Order Number LM27313XMF, or LM27313XMF**  
**NS Package Number MF05A**

MF05A (Rev C)

# Notes

LM27313

## Notes

THE CONTENTS OF THIS DOCUMENT ARE PROVIDED IN CONNECTION WITH NATIONAL SEMICONDUCTOR CORPORATION ("NATIONAL") PRODUCTS. NATIONAL MAKES NO REPRESENTATIONS OR WARRANTIES WITH RESPECT TO THE ACCURACY OR COMPLETENESS OF THE CONTENTS OF THIS PUBLICATION AND RESERVES THE RIGHT TO MAKE CHANGES TO SPECIFICATIONS AND PRODUCT DESCRIPTIONS AT ANY TIME WITHOUT NOTICE. NO LICENSE, WHETHER EXPRESS, IMPLIED, ARISING BY ESTOPPEL OR OTHERWISE, TO ANY INTELLECTUAL PROPERTY RIGHTS IS GRANTED BY THIS DOCUMENT.

TESTING AND OTHER QUALITY CONTROLS ARE USED TO THE EXTENT NATIONAL DEEMS NECESSARY TO SUPPORT NATIONAL'S PRODUCT WARRANTY. EXCEPT WHERE MANDATED BY GOVERNMENT REQUIREMENTS, TESTING OF ALL PARAMETERS OF EACH PRODUCT IS NOT NECESSARILY PERFORMED. NATIONAL ASSUMES NO LIABILITY FOR APPLICATIONS ASSISTANCE OR BUYER PRODUCT DESIGN. BUYERS ARE RESPONSIBLE FOR THEIR PRODUCTS AND APPLICATIONS USING NATIONAL COMPONENTS. PRIOR TO USING OR DISTRIBUTING ANY PRODUCTS THAT INCLUDE NATIONAL COMPONENTS, BUYERS SHOULD PROVIDE ADEQUATE DESIGN, TESTING AND OPERATING SAFEGUARDS.

EXCEPT AS PROVIDED IN NATIONAL'S TERMS AND CONDITIONS OF SALE FOR SUCH PRODUCTS, NATIONAL ASSUMES NO LIABILITY WHATSOEVER, AND NATIONAL DISCLAIMS ANY EXPRESS OR IMPLIED WARRANTY RELATING TO THE SALE AND/OR USE OF NATIONAL PRODUCTS INCLUDING LIABILITY OR WARRANTIES RELATING TO FITNESS FOR A PARTICULAR PURPOSE, MERCHANTABILITY, OR INFRINGEMENT OF ANY PATENT, COPYRIGHT OR OTHER INTELLECTUAL PROPERTY RIGHT.

### LIFE SUPPORT POLICY

**NATIONAL'S PRODUCTS ARE NOT AUTHORIZED FOR USE AS CRITICAL COMPONENTS IN LIFE SUPPORT DEVICES OR SYSTEMS WITHOUT THE EXPRESS PRIOR WRITTEN APPROVAL OF THE CHIEF EXECUTIVE OFFICER AND GENERAL COUNSEL OF NATIONAL SEMICONDUCTOR CORPORATION.** As used herein:

Life support devices or systems are devices which (a) are intended for surgical implant into the body, or (b) support or sustain life and whose failure to perform when properly used in accordance with instructions for use provided in the labeling can be reasonably expected to result in a significant injury to the user. A critical component is any component in a life support device or system whose failure to perform can be reasonably expected to cause the failure of the life support device or system or to affect its safety or effectiveness.

National Semiconductor and the National Semiconductor logo are registered trademarks of National Semiconductor Corporation. All other brand or product names may be trademarks or registered trademarks of their respective holders.

Copyright© 2007 National Semiconductor Corporation

For the most current product information visit us at [www.national.com](http://www.national.com)



**National Semiconductor Americas Customer Support Center**  
 Email: [new.feedback@nsc.com](mailto:new.feedback@nsc.com)  
 Tel: 1-800-272-9959

**National Semiconductor Europe Customer Support Center**  
 Fax: +49 (0) 180-530-85-86  
 Email: [europe.support@nsc.com](mailto:europe.support@nsc.com)  
 Deutsch Tel: +49 (0) 69 9508 6208  
 English Tel: +49 (0) 870 24 0 2171  
 Français Tel: +33 (0) 1 41 91 8790

**National Semiconductor Asia Pacific Customer Support Center**  
 Email: [ap.support@nsc.com](mailto:ap.support@nsc.com)

**National Semiconductor Japan Customer Support Center**  
 Fax: 81-3-5639-7507  
 Email: [jpn.feedback@nsc.com](mailto:jpn.feedback@nsc.com)  
 Tel: 81-3-5639-7560