

General Description

The MIC29710 and MIC29712 are high-current, high-accuracy, low-dropout voltage regulators featuring fast transient recovery from input voltage surges and output load current changes. These regulators use a PNP pass element that features Micrel's proprietary Super Beta PNP[®] process.

The MIC29710 is available in the 3-pin fixed output and the MIC29712 is available in the 5-pin adjustable output voltage. Both versions are fully protected against overcurrent faults, reversed lead insertion, over-temperature operation, and positive and negative transient voltage spikes.

A TTL compatible enable (EN) control pin supports external on/off control. If on/off control is not required, the device maybe continuously enabled by connecting EN to IN.

The MIC29710 is available in the standard 3-pin TO-220 package the MIC29712 is available in the 5-pin TO-220 package with an operating junction temperature range of 0°C to +125°C.

For applications requiring even lower dropout voltage or input voltage greater than 16V, see the MIC29750/29752.

Data sheets and support documentation can be found on Micrel's web site at www.micrel.com.

Features

- Fast transient response
- 7.5A current capability
- 700mV dropout voltage at full load
- Low ground current
- Accurate 2% guaranteed tolerance
- "Zero" current shutdown mode (MIC29712)
- Fixed voltage and adjustable versions

Applications

- Pentium[®], Pentium[®] Plus, and Power PC[®] processor supplies
- High-efficiency "green" computer systems
- High-efficiency linear power supplies
- High-efficiency switching supply post regulator
- Battery-powered equipment

Typical Application

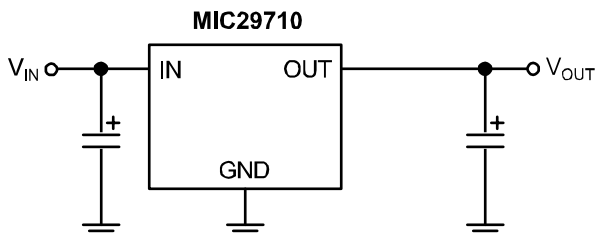

Fixed Regulator Configuration

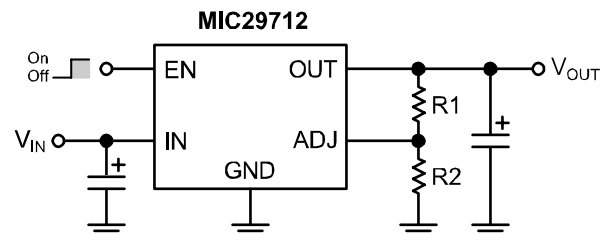

$$V_{OUT} = 1.240 \left(\frac{R1}{R2} + 1 \right)$$

Adjustable Regulator Configuration

Super Beta PNP is a registered trademark of Micrel, Inc. Pentium is a registered trademark of Intel Corporation. PowerPC is a registered trademark of IBM Corporation.

Micrel Inc. • 2180 Fortune Drive • San Jose, CA 95131 • USA • tel +1 (408) 944-0800 • fax + 1 (408) 474-1000 • <http://www.micrel.com>

Ordering Information⁽¹⁾

Part Number		Voltage	Junction Temp. Range	Package
Standard	RoHS Compliant*			
MIC29710-3.3BT	MIC29710-3.3WT	3.3V	0°C to +125°C	3-Pin TO-220
MIC29710-5.0BT	MIC29710-5.0WT	5.0V	0°C to +125°C	3-Pin TO-220
MIC29712BT	MIC29712WT	Adj	0°C to +125°C	5-Pin TO-220

Note:

* RoHS Compliant with 'high-melting solder' exemption.

Pin Configuration

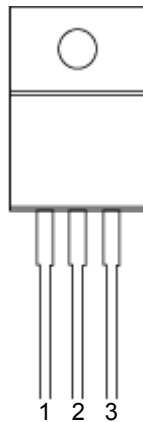

MIC29710BT/WT

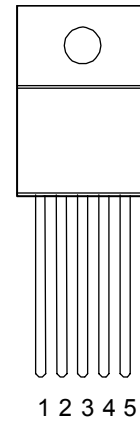

MIC29712BT/WT

On both devices, the Tab is grounded

Pin Description

Pin Number 3-Pin TO-220	Pin Number 5-Pin TO-220	Pin Name	Pin Name
–	1	EN	Enable (Input): Logic-level ON/OFF control.
1	2	IN	Unregulated Input: +16V maximum supply.
2	3	GND	Ground: Internally connected to tab (ground).
3	4	OUT	Regulated Output
–	5	ADJ	Output Voltage Adjust: 1.240V feedback from external resistive divider.

Absolute Maximum Ratings

Input Supply Voltage (V_{IN})⁽¹⁾ -0.7V to +20V
 Power Dissipation. Internally Limited
 Lead Temperature (soldering, 5 sec.) 260°C
 Storage Temperature (T_s) -65°C to 150°C
 EDS Rating⁽²⁾

Operating Ratings

Junction Temperature (T_J) 0°C to +125°C
 Thermal Resistance
 TO-220 (θ_{JC}) 2°C/W
 TO-220 (θ_{JA}) 55°C/W

Electrical Characteristics⁽³⁾

All measurements at $T_J = 25^\circ\text{C}$ unless otherwise noted. **Bold** values are guaranteed across the operating temperature range.

Parameter	Condition	Min	Typ	Max	Units
Output Voltage	$10\text{mA} \leq I_O \leq 7.5\text{A}$, $(V_{OUT} + 1\text{V}) \leq V_{IN} \leq 8\text{V}$, Note 4	-2		+2	%
Line Regulation	$I_O = 10\text{mA}$, $(V_{OUT} + 1\text{V}) \leq V_{IN} \leq 8\text{V}$		0.06	0.5	%
Load Regulation	$V_{IN} = V_{OUT} + 1\text{V}$, $10\text{mA} \leq I_{OUT} \leq 7.5\text{A}$, Notes 4, 8		0.2	1	%
Output Voltage Temperature Coefficient	$\Delta V_O / \Delta T$, Note 8		20	100	ppm/°C
Dropout Voltage	$\Delta V_{OUT} = -1\%$, Note 5 MIC29710/29712 $I_O = 100\text{mA}$ $I_O = 750\text{mA}$ $I_O = 1.5\text{A}$ $I_O = 3\text{A}$ $I_O = 5\text{A}$ $I_O = 7.5\text{A}$		80 180 220 300 450 700	200 1000	mV mV mV mV mV mV
Ground Current	MIC29710/29712 $I_O = 750\text{mA}$, $V_{IN} = V_{OUT} + 1\text{V}$ $I_O = 1.5\text{A}$ $I_O = 3\text{A}$ $I_O = 5\text{A}$ $I_O = 7.5\text{A}$		6 20 36 100 250	20 375	mA mA mA mA mA
I_{GNDDO} Ground Pin Current at Dropout	$V_{IN} = 0.5\text{V}$ less than specified V_{OUT} . $I_{OUT} = 10\text{mA}$		1	2	mA
Current Limit	MIC29710/29712 $V_{OUT} = 0\text{V}$, Note 6		11	15	A
e_n , Output Noise Voltage (10Hz to 10kHz) $V_{OUT} = 5.0\text{V}$	$C_L = 47\mu\text{F}$ $I_O = 100\text{mA}$		260		μV_{RMS}
Reference (MIC29712 only)					
Reference Voltage	$10\text{mA} \leq I_O \leq 7.5\text{A}$, $V_{OUT} + 1\text{V} \leq V_{IN} \leq 8\text{V}$, Note 4	1.215	1.240	1.265	V_{MAX}
Adjust Pin Bias Current			40	80 120	nA nA
Reference Voltage Temperature Coefficient	Note 9		20		ppm/°C
Adjust Pin Bias Current Temperature Coefficient			0.1		nA/°C
Enable Input (MIC29712 only)					
Input Logic Voltage	Low (Off) High (On)	2.4		0.8	V V
Enable (EN) Pin Input Current	$V_{EN} = V_{IN}$		15	30 75	μA μA
	$V_{EN} = 0.8\text{V}$		-	2 4	μA μA
Regulator Output Current in Shutdown	Note 10		10	20	μA μA

Notes:

1. The maximum continuous supply voltage is 16V.
2. Devices are ESD sensitive. Handling precautions are recommended.
3. Specification for packaged product only.
4. For testing, MIC29712 V_{OUT} is programmed to 5V.
5. Dropout voltage is defined as the input-to-output differential when the output voltage drops to 99% of its nominal value with $V_{OUT} + 1V$ applied to V_{IN} .
6. For this test, V_{IN} is the larger of 8V or $V_{OUT} + 3V$.
7. Ground pin current is the regulator quiescent current. The total current drawn from the source is the sum of the load current plus the ground pin current.
8. Output voltage temperature coefficient is defined as the worst case voltage change divided by the total temperature range.
9. $V_{REF} \leq V_{OUT} \leq (V_{IN} - 1V)$, $2.4V \leq V_{IN} \leq 8V$, $10mA < I_L \leq 7.5A$, $T_J \leq T_{JMAX}$.
10. $V_{EN} \leq 0.8V$ and $V_{IN} \leq 16V$, $V_{OUT} = 0$.

Typical Characteristics

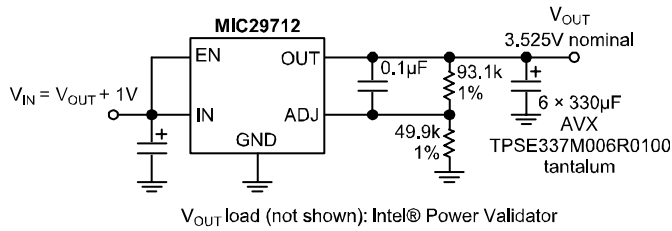

MIC29710 Load Transient Response Test Circuit

MIC29712 Load Transient Response (See Test Circuit Schematic)

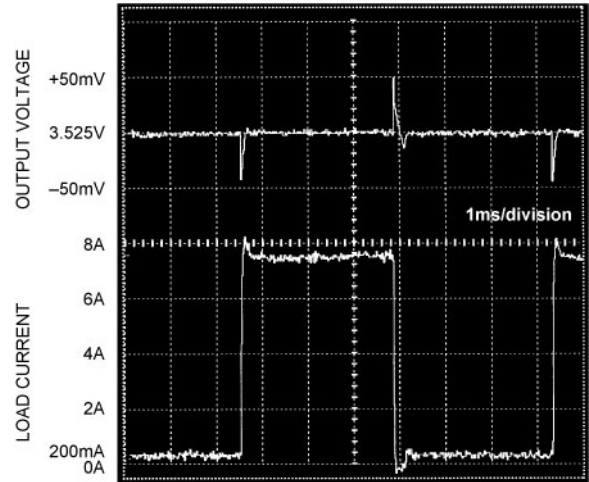

MIC29712 Line Transient Response with 10mA Load, 10µF Output Capacitance

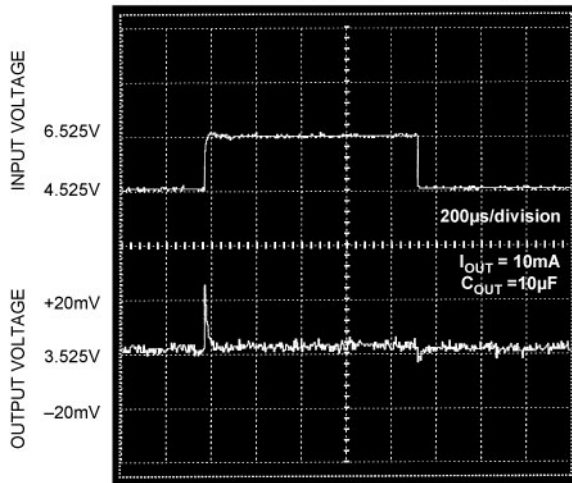

MIC29712 Line Transient Response with 100mA Load, 100µF Output Capacitance

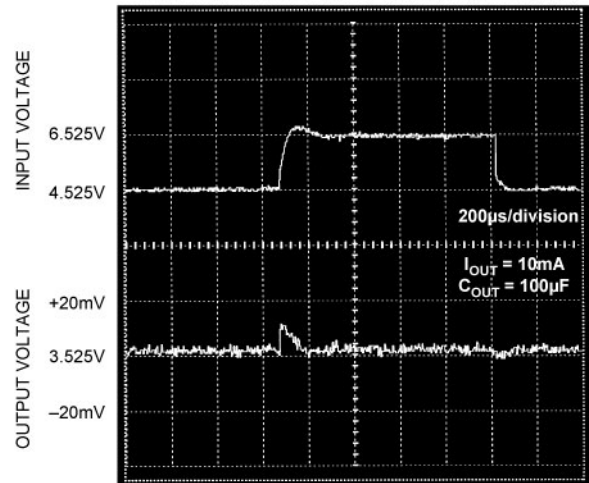

MIC29710/2 Dropout Voltage vs. Output Current

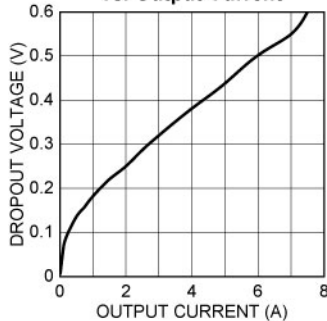

MIC29710/2 Dropout Voltage vs. Temperature

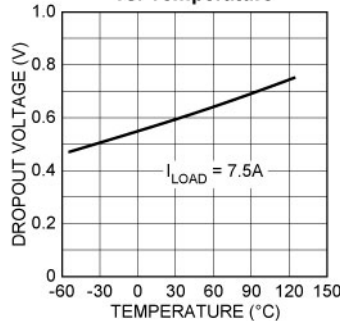

MIC29710-3.3 Dropout Characteristics

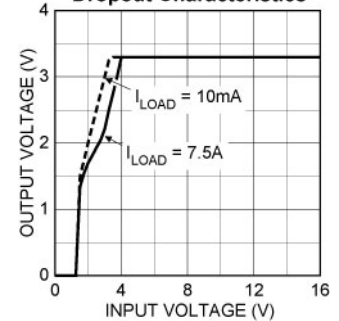

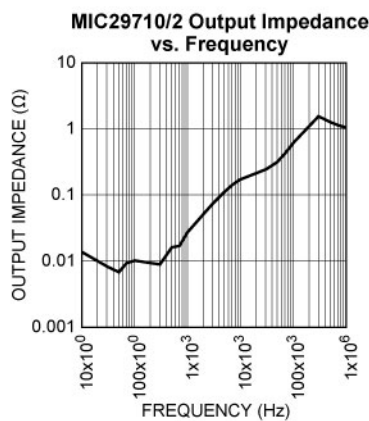
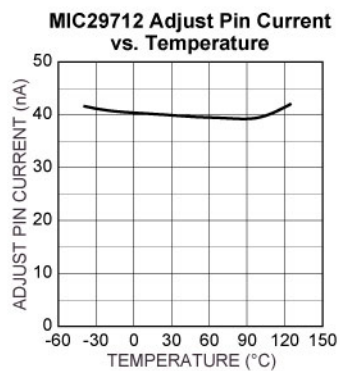
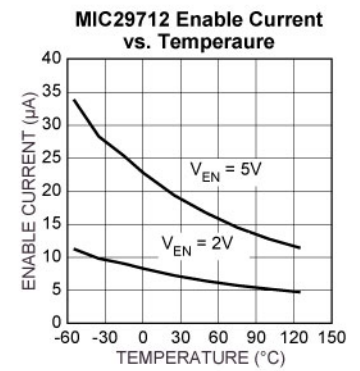
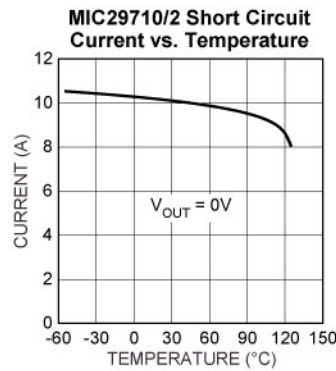
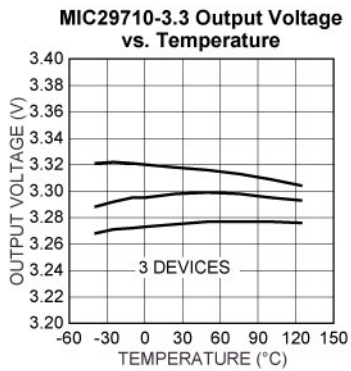
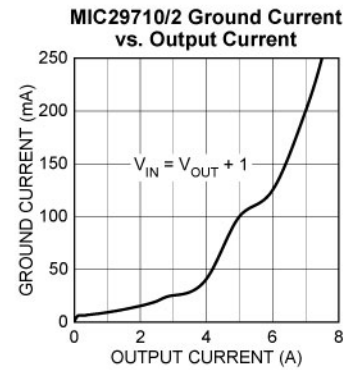
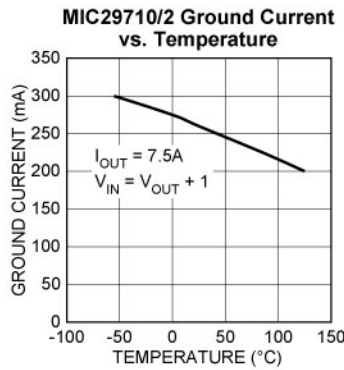
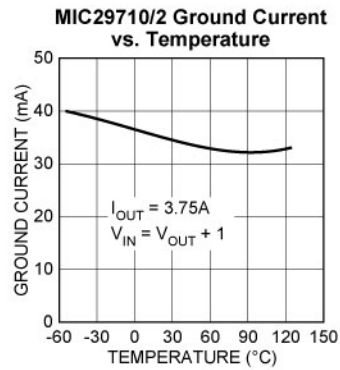
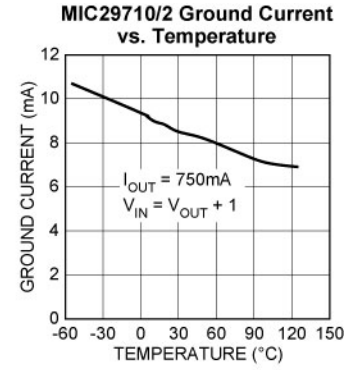
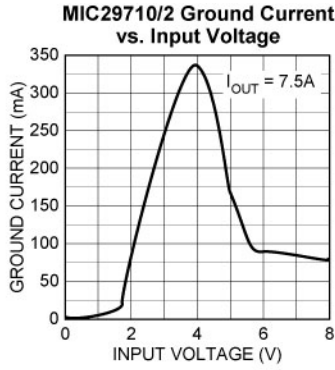
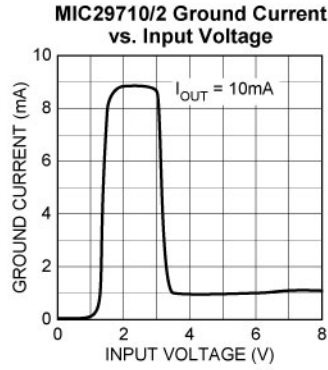

Functional Diagram

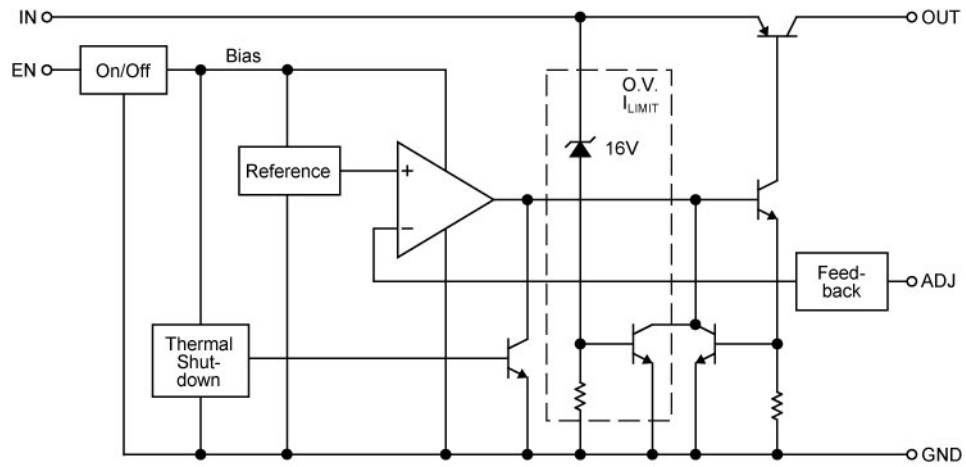

Application Information

The MIC29710 and MIC29712 are high performance low-dropout voltage regulators suitable for all moderate to high-current voltage regulator applications. Their 700mV of drop-out voltage at full load make them especially valuable in battery powered systems and as high efficiency noise filters in “post-regulator” applications. Unlike older NPN-pass transistor designs, where the minimum dropout voltage is limited by the base-emitter voltage drop and collector-emitter saturation voltage, dropout performance of the PNP output of these devices is limited merely by the low V_{CE} saturation voltage. Output regulation is excellent across the input voltage, output current, and temperature ranges.

A trade-off for the low dropout voltage is a varying base drive requirement. But Micrel’s Super β PNP[®] process reduces this drive requirement to merely 2 to 5% of the load current.

MIC29710/712 regulators are fully protected from damage due to fault conditions. Current limiting is provided. The output current under overload conditions is limited to a constant value. Thermal shutdown disables the device when the die temperature exceeds the maximum safe operating temperature. Transient protection allows device (and load) survival even when the input voltage spike above and below nominal. The MIC29712 version offers a logic level ON/OFF control: when disabled, the devices draw nearly zero current.

An additional feature of this regulator family is a common pinout: a design’s current requirement may change up or down yet use the same board layout, as all of Micrel’s high-current Super β PNP[®] regulators have identical pinouts.

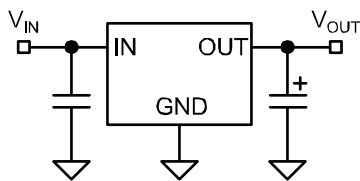

Figure 3. The MIC29710 requires only two capacitors for operation

Thermal Design

Linear regulators are simple to use. The most complicated design parameters to consider are thermal characteristics. Thermal design requires the following application-specific parameters:

- Maximum ambient temperature, T_A
- Output Current, I_{OUT}
- Output Voltage, V_{OUT}
- Input Voltage, V_{IN} .

First, we calculate the power dissipation of the regulator from these numbers and the device parameters from this datasheet.

$$P_D = I_{OUT} \times (1.03V_{IN} - V_{OUT})$$

Where the ground current is approximated by 3% of I_{OUT} . Then the heat sink thermal resistance is determined with this formula:

$$\theta_{SA} = \frac{T_{JMAX} - T_A}{P_D} - (\theta_{JC} + \theta_{CS})$$

Where $T_{JMAX} \leq 125^\circ\text{C}$ and θ_{CS} is between 0 and 2°C/W .

The heat sink may be significantly reduced in applications where the minimum input voltage is known and is large compared with the dropout voltage. Use a series input resistor to drop excessive voltage and distribute the heat between this resistor and the regulator. The low dropout properties of Micrel Super β PNP regulators allow very significant reductions in regulator power dissipation and the associated heat sink without compromising performance. When this technique is employed, a capacitor of at least $0.1\mu\text{F}$ is needed directly between the input and regulator ground.

Please refer to Application Note 9 for further details and examples on thermal design and heat sink specification.

Capacitor Requirements

For stability and minimum output noise, a capacitor on the regulator output is necessary. The value of this capacitor is dependent upon the output current; lower currents allow smaller capacitors. MIC29710/2 regulators are stable with a minimum capacitor value of $47\mu\text{F}$ at full load.

This capacitor need not be an expensive low ESR type: aluminum electrolytics are adequate. In fact, extremely low ESR capacitors may contribute to instability. Tantalum capacitors are recommended for systems where fast load transient response is important.

Where the regulator is powered from a source with a high AC impedance, a $0.1\mu\text{F}$ capacitor connected between Input and GND is recommended. This capacitor should have good characteristics to above 250kHz.

Transient Response and 5V to 3.3V Conversion

The MIC29710/2 have excellent response to variations in input voltage and load current. By virtue of their low dropout voltage, these devices do not saturate into dropout as readily as similar NPN-based designs. A 3.3V output Micrel LDO will maintain full speed and performance with an input supply as low as 4.2V, and will still provide some regulation with supplies down to 3.8V, unlike NPN devices that require 5.1V or more for good performance and become nothing more than a resistor under 4.6V of input. Micrel’s PNP regulators provide superior performance in “5V to 3.3V” conversion applications, especially when all tolerances are considered.

Adjustable Regulator Design

The adjustable regulator version, MIC29712, allows programming the output voltage anywhere between 1.25V and the 16V maximum operating rating of the family. Two resistors are used. Resistors can be quite large, up to 100kΩ, because of the very high input impedance and low bias current of the sense comparator. The resistor values are calculated by:

$$R1 = R2 \times \left(\frac{V_{OUT}}{1.240} - 1 \right)$$

Where V_O is the desired output voltage. Figure 4 shows component definition.

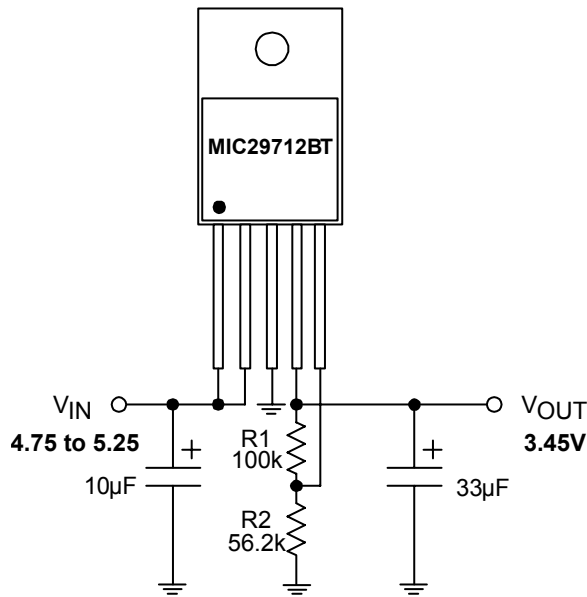

$$V_{OUT} = 1.240V \times [1 + (R1 / R2)]$$

Figure 4. Adjustable Regulator with Resistors

Enable Input

The MIC29712 versions features an enable (EN) input that allows ON/OFF control of the device. Special design allows “zero” current drain when the device is disabled—only micro-amperes of leakage current flows. The EN input has TTL/CMOS compatible thresholds for simple interfacing with logic, or may be directly tied to V_{IN} . Enabling the regulator requires approximately 20µA of current into the EN pin.

Minimum Load Current

The MIC29710/12 regulators are specified between finite loads. If the output current is too small, leakage currents dominate and the output voltage rises. A 10mA minimum load current is necessary for proper regulation.

Voltage	Standard (Ω)	
	R1	R2
2.85	100k	76.8k
2.9	100k	75.0k
3.0	100k	69.8k
3.1	100k	66.5k
3.15	100k	64.9k
3.3	100k	60.4k
3.45	100k	56.2k
3.525	93.1k	51.1k
3.6	100k	52.3k
3.8	100k	48.7k
4.0	100k	45.3k
4.1	100k	43.2k

Figure 5. MIC29712 Resistor Table

Package Information

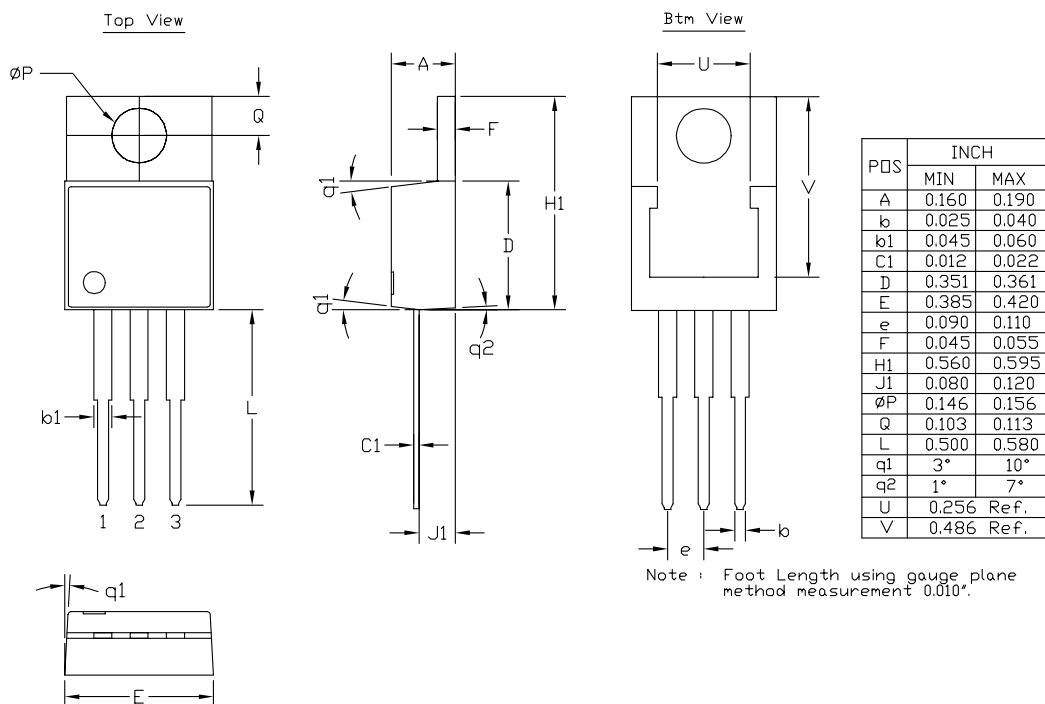

3-Pin TO-220 (T)

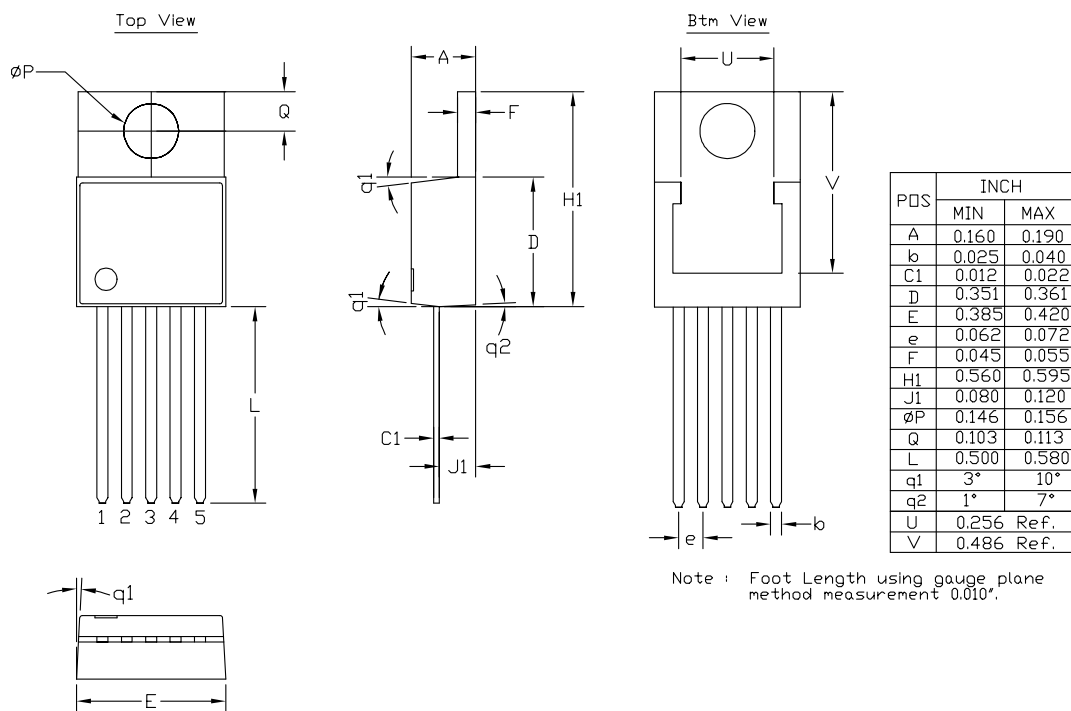

5-Pin TO-220 (T)

MICREL, INC. 2180 FORTUNE DRIVE SAN JOSE, CA 95131 USA
TEL +1 (408) 944-0800 FAX +1 (408) 474-1000 WEB <http://www.micrel.com>

The information furnished by Micrel in this data sheet is believed to be accurate and reliable. However, no responsibility is assumed by Micrel for its use. Micrel reserves the right to change circuitry and specifications at any time without notification to the customer.

Micrel Products are not designed or authorized for use as components in life support appliances, devices or systems where malfunction of a product can reasonably be expected to result in personal injury. Life support devices or systems are devices or systems that (a) are intended for surgical implant into the body or (b) support or sustain life, and whose failure to perform can be reasonably expected to result in a significant injury to the user. A Purchaser's use or sale of Micrel Products for use in life support appliances, devices or systems is a Purchaser's own risk and Purchaser agrees to fully indemnify Micrel for any damages resulting from such use or sale.

© 2004 Micrel, Incorporated.