

FEATURES

- Precision 1.000 V voltage reference
- Ultracompact 3 mm × 3 mm SOT-23 package
- No external capacitor required
- Low output noise: 4 μV p-p (0.1 Hz to 10 Hz)
- Initial accuracy: ±0.35% maximum
- Temperature coefficient: 70 ppm/°C maximum
- Operating current range: 100 μA to 10 mA
- Output impedance: 0.3 Ω maximum
- Temperature range: -40°C to +85°C

APPLICATIONS

- Precision data acquisition systems
- Battery-powered equipment
 - Cellular phone
 - Notebook computer
 - PDA
 - GPS
- 3 V/5 V, 8-/12-bit data converters
- Portable medical instruments
- Industrial process control systems
- Precision instruments

GENERAL DESCRIPTION

Designed for space critical applications, the ADR510 is a low voltage (1.000 V), precision shunt-mode voltage reference in an ultracompact (3 mm × 3 mm) SOT-23-3 package. The ADR510 features low temperature drift (70 ppm/°C), high accuracy (±0.35%), and ultralow noise (4 μV p-p) performance.

The ADR510 advanced design eliminates the need for an external capacitor, yet it is stable with any capacitive load. The minimum operating current increases from 100 μA to a maximum of 10 mA. This low operating current and ease of use make the ADR510 ideally suited for handheld battery-powered applications.

A TRIM terminal is available on the ADR510 to provide adjustment of the output voltage over ±0.5% without affecting the temperature coefficient of the device. This feature provides users with the flexibility to trim out any system errors.

PIN CONFIGURATION

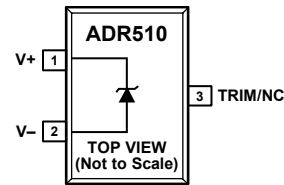

NC = NO CONNECT

Figure 1. 3-Lead SOT-23-3

03270-001

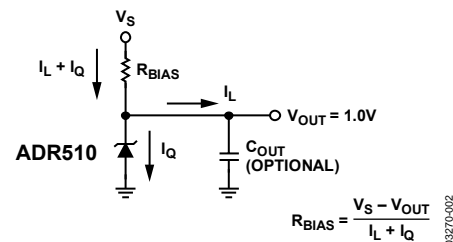

Figure 2. Typical Operating Circuit

03270-002

Table 1. ADR510

Part	Output Voltage, V _{OUT}	Initial Accuracy	Temperature Coefficient
ADR510A	1.000 V	3.5 mV 0.35%	70 ppm/°C

Rev. B

Information furnished by Analog Devices is believed to be accurate and reliable. However, no responsibility is assumed by Analog Devices for its use, nor for any infringements of patents or other rights of third parties that may result from its use. Specifications subject to change without notice. No license is granted by implication or otherwise under any patent or patent rights of Analog Devices. Trademarks and registered trademarks are the property of their respective owners.

TABLE OF CONTENTS

Features	1	Parameter Definitions.....	7
Applications.....	1	Temperature Coefficient.....	7
Pin Configuration.....	1	Thermal Hysteresis	7
General Description	1	Applications Information	8
Revision History	2	Adjustable Precision Voltage Source.....	8
Specifications.....	3	Output Voltage Trim	8
Electrical Characteristics	3	Using the ADR510 with Precision Data Converters	8
Absolute Maximum Ratings.....	4	Precise Negative Voltage Reference	9
Thermal Resistance	4	Outline Dimensions	10
ESD Caution.....	4	Ordering Guide	10
Typical Performance Characteristics	5		

REVISION HISTORY

9/07—Rev. A to Rev. B

Changes to Adjustable Precision Voltage Source Section	8
Changes to Figure 11	8
Changes to Figure 12.....	8

4/07—Rev. 0 to Rev. A

Changes to Table 1	1
Changes to Table 3 and Table 4.....	4
Changes to Figure 4, Figure 5, Figure 6, and Figure 7	5
Changes to Thermal Hysteresis Section	7
Changes to Figure 11	8
Changes to Figure 14 and Equation 5	9
Changes to Ordering Guide	10

8/03—Revision 0: Initial Version

SPECIFICATIONS

ELECTRICAL CHARACTERISTICS

$I_{IN} = 100 \mu\text{A}$ to 10 mA @ $T_A = 25^\circ\text{C}$, unless otherwise noted.

Table 2.

Parameter	Symbol	Conditions	Min	Typ	Max	Unit
Output Voltage ¹	V_{OUT}		0.9965	1.0	1.0035	V
Initial Accuracy	V_{OUTERR}		-3.5		+3.5	mV
	$V_{OUTERR\%}$		-0.35		+0.35	%
Temperature Coefficient, A Grade	TCV_{OUT}	$0^\circ\text{C} < T_A < 70^\circ\text{C}$			70	ppm/ $^\circ\text{C}$
		$-40^\circ\text{C} < T_A < +85^\circ\text{C}$			85	ppm/ $^\circ\text{C}$
Output Voltage Change vs. I_{IN}	ΔV_R	$I_{IN} = 0.1 \text{ mA}$ to 10 mA			3	mV
Dynamic Output Impedance	$(\Delta V_R / \Delta I_R)$	$I_{IN} = 1 \text{ mA} \pm 100 \mu\text{A}$			0.3	Ω
Minimum Operating Current	I_{IN}	$0^\circ\text{C} < T_A < 70^\circ\text{C}$	100			μA
Voltage Noise	e_N p-p	$f = 0.1 \text{ Hz}$ to 10 Hz		4		μV p-p
Turn-On Settling Time ²	t_R	To within 0.1% of output		10		μs
Output Voltage Hysteresis	V_{OUT_HYS}			50		ppm

¹ The forward diode voltage characteristic at -1 mA is typically 0.65 V .

² Measured without a load capacitor.

ABSOLUTE MAXIMUM RATINGS

Table 3.

Parameter	Rating
Reverse Current	25 mA
Forward Current	20 mA
Storage Temperature Range	-65°C to +150°C
Operating Temperature Range	-40°C to +85°C
Junction Temperature Range	-65°C to +150°C
Lead Temperature (Soldering, 60 sec)	300°C

Stresses above those listed under Absolute Maximum Ratings may cause permanent damage to the device. This is a stress rating only; functional operation of the device at these or any other conditions above those indicated in the operational section of this specification is not implied. Exposure to absolute maximum rating conditions for extended periods may affect device reliability.

THERMAL RESISTANCE

θ_{JA} is specified for the worst-case conditions, that is, a device soldered in a circuit board for surface-mount packages. Package power dissipation = $(T_{JMAX} - T_A)/\theta_{JA}$.

Table 4. Thermal Resistance

Package Type	θ_{JA}	θ_{JC}	Unit
3-Lead SOT-23-3 (RT-3)	230	146	°C/W

ESD CAUTION



ESD (electrostatic discharge) sensitive device. Charged devices and circuit boards can discharge without detection. Although this product features patented or proprietary protection circuitry, damage may occur on devices subjected to high energy ESD. Therefore, proper ESD precautions should be taken to avoid performance degradation or loss of functionality.

TYPICAL PERFORMANCE CHARACTERISTICS

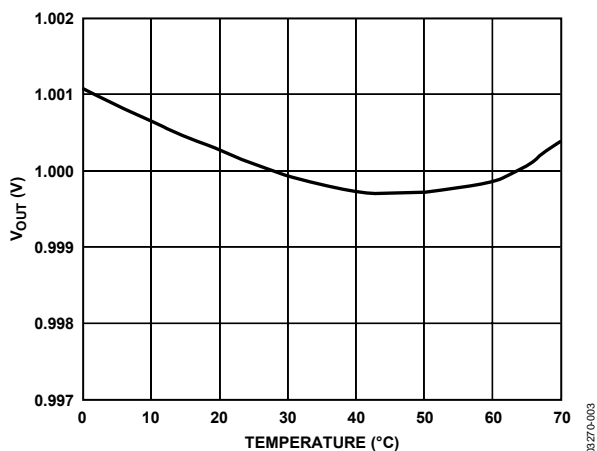

Figure 3. Typical V_{OUT} vs. Temperature

03270-003

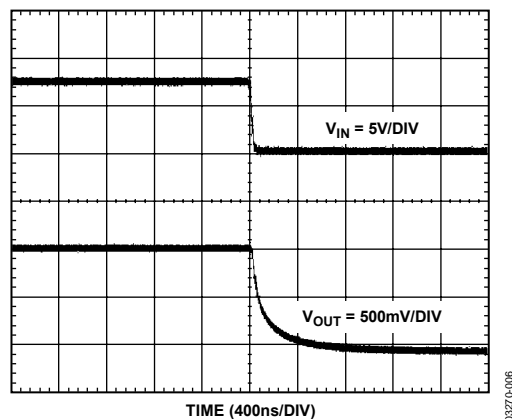

Figure 6. Turn-Off Time

03270-006

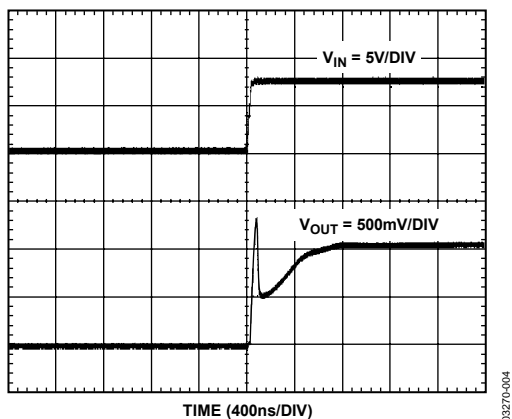

Figure 4. Turn-On Time

03270-004

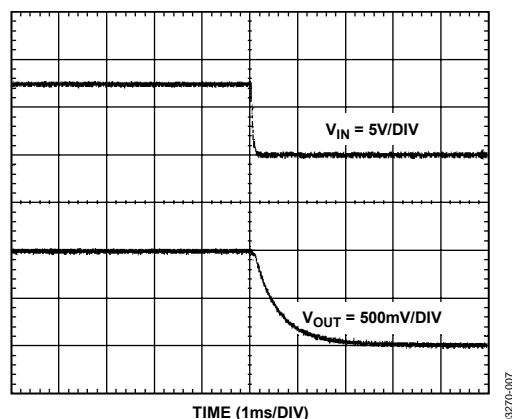

Figure 7. Turn-Off Time with 1 μ F Input Capacitor

03270-007

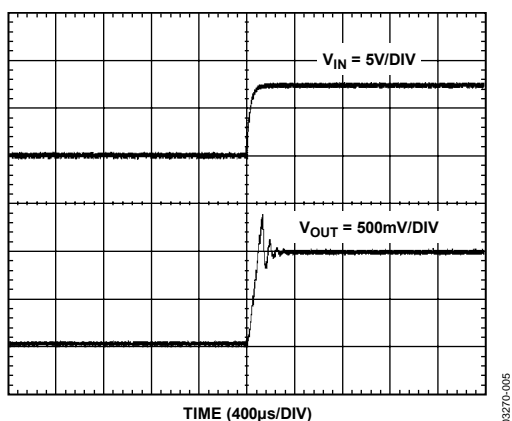

Figure 5. Turn-On Time with 1 μ F Input Capacitor

03270-005

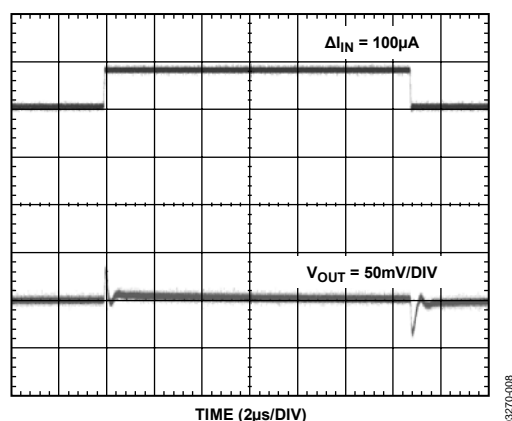

Figure 8. Output Response to 100 μ A Input Current Change

03270-008

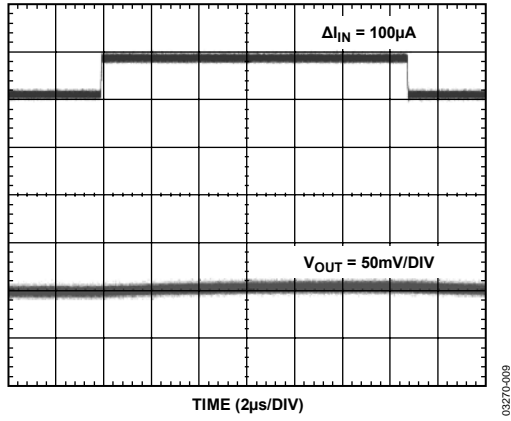

Figure 9. Output Response to 100 μA Input Current Change with 1 μF Capacitor

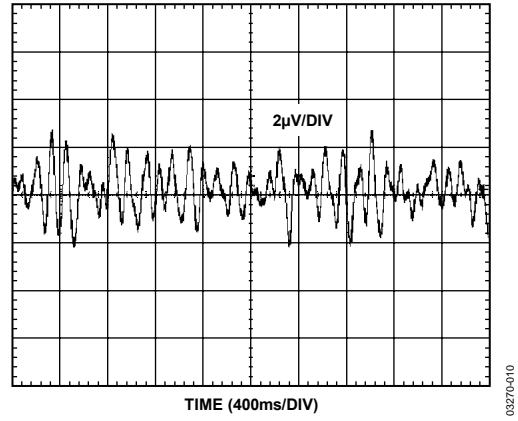

Figure 10. 1 Hz to 10 Hz Noise

PARAMETER DEFINITIONS

TEMPERATURE COEFFICIENT

This is the change of output voltage with respect to the operating temperature changes, normalized by the output voltage at 25°C. This parameter is expressed in parts per million/degrees Celsius (ppm/°C) and can be determined with the following equation:

$$TCV_{OUT}[\text{ppm}/^{\circ}\text{C}] = \frac{V_{OUT}(T2) - V_{OUT}(T1)}{V_{OUT}(25^{\circ}\text{C}) \times (T2 - T1)} \times 10^6 \quad (1)$$

where:

$V_{OUT}(25^{\circ}\text{C})$ is the output voltage at 25°C.

$V_{OUT}(T_1)$ is the output voltage at Temperature 1.

$V_{OUT}(T_2)$ is the output voltage at Temperature 2.

THERMAL HYSTERESIS

Thermal hysteresis is the change of output voltage after the device is cycled through the temperature from 25°C to 0°C to 85°C and back to 25°C.

$$V_{OUT_HYS} = V_{OUT}(25^{\circ}\text{C}) - V_{OUT_TC}$$

$$V_{OUT_HYS}[\text{ppm}] = \frac{V_{OUT}(25^{\circ}\text{C}) - V_{OUT_TC}}{V_{OUT}(25^{\circ}\text{C})} \times 10^6 \quad (2)$$

where:

$V_{OUT}(25^{\circ}\text{C})$ is the output voltage at 25°C.

V_{OUT_TC} is the output voltage at 25°C after temperature cycle at +25°C to -40°C to +85°C and back to +25°C.

APPLICATIONS INFORMATION

The ADR510 is a 1.0 V precision shunt voltage reference designed to operate without an external output capacitor between the positive terminal and the negative terminal for stability. An external capacitor can be used for additional filtering of the supply.

As with all shunt voltage references, an external bias resistor (R_{BIAS}) is required between the supply voltage and the ADR510 (see Figure 2). R_{BIAS} sets the current that is required to pass through the load (I_L) and the ADR510 (I_Q). The load and the supply voltage can vary, thus R_{BIAS} is chosen based on the following conditions:

- R_{BIAS} must be small enough to supply the minimum I_Q current to the ADR510 even when the supply voltage is at minimum value and the load current is at maximum value.
- R_{BIAS} also needs to be large enough so that I_Q does not exceed 10 mA when the supply voltage is at its maximum value and the load current is at its minimum value.

Given these conditions, R_{BIAS} is determined by the supply voltage (V_S), the load and operating current (I_L and I_Q) of the ADR510, and the ADR510 output voltage.

$$R_{BIAS} = \frac{V_S - V_{OUT}}{I_L + I_Q} \quad (3)$$

ADJUSTABLE PRECISION VOLTAGE SOURCE

The ADR510, combined with a precision low input bias op amp such as the AD860x, can be used to output a precise adjustable voltage. Figure 11 illustrates implementation of this application using the ADR510.

Output of the op amp, V_{OUT} , is determined by the gain of the circuit, which is completely dependent on the $R2$ and $R1$ resistors.

$$V_{OUT} = 1 + \frac{R2}{R1} \quad (4)$$

An additional capacitor in parallel with $R2$ can be added to filter out high frequency noise. The value of $C2$ is dependent on the value of $R2$.

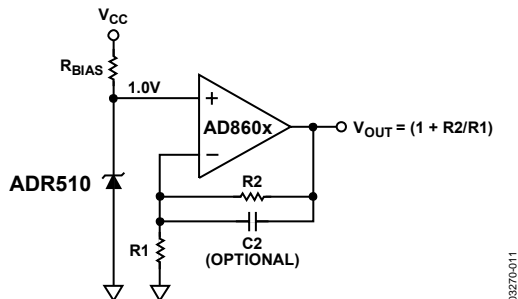

Figure 11. Adjustable Precision Voltage Source

OUTPUT VOLTAGE TRIM

Using a mechanical or digital potentiometer, the output voltage of the ADR510 can be trimmed $\pm 0.5\%$. The circuit in Figure 12 illustrates how the output voltage can be trimmed using a 10 k Ω potentiometer. Note that trimming using other resistor values may not produce an accurate output from the ADR510.

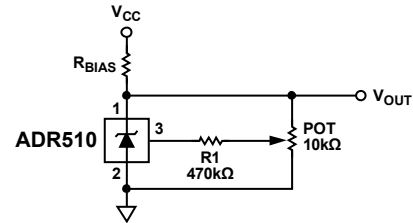

Figure 12. Output Voltage Trim

USING THE ADR510 WITH PRECISION DATA CONVERTERS

The compact ADR510 and its low minimum operating current requirement make it ideal for use in battery-powered portable instruments, such as the AD7533 CMOS multiplying DAC, that use precision data converters.

Figure 13 shows the ADR510 serving as an external reference to the AD7533, a CMOS multiplying DAC. Such a DAC requires a negative voltage input in order to provide a positive output range. In this application, the ADR510 is supplying a -1.0 V reference to the REF input of the AD7533.

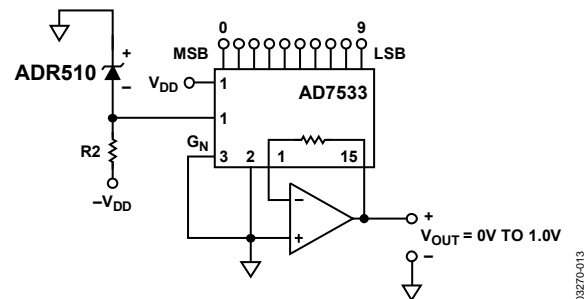

Figure 13. ADR510 as a Reference for a 10-Bit CMOS DAC (AD7533)

PRECISE NEGATIVE VOLTAGE REFERENCE

The ADR510 is suitable for use in applications where a precise negative voltage reference is desired, including the application detailed in Figure 13.

Figure 14 shows the ADR510 configured to provide an output of -1.0 V.

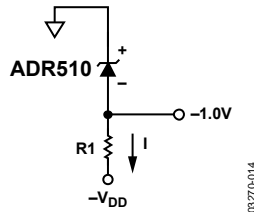

Figure 14. Precise -1.0 V Reference Configuration

Because the ADR510 characteristics resemble those of a Zener diode, the cathode shown in Figure 14 is 1.0 V higher with respect to the anode ($V+$ with respect to $V-$ on the ADR510 package). Because the cathode of the ADR510 is tied to ground, the anode must be -1.0 V.

R1 in Figure 14 should be chosen so that 100 μ A to 10 mA is provided to properly bias the ADR510.

$$RI = \frac{-1 - (-V_{DD})}{I} \tag{5}$$

The R1 resistor should be chosen so that power dissipation is at a minimum. An ideal resistor value can be determined through manipulation of Equation 5.

OUTLINE DIMENSIONS

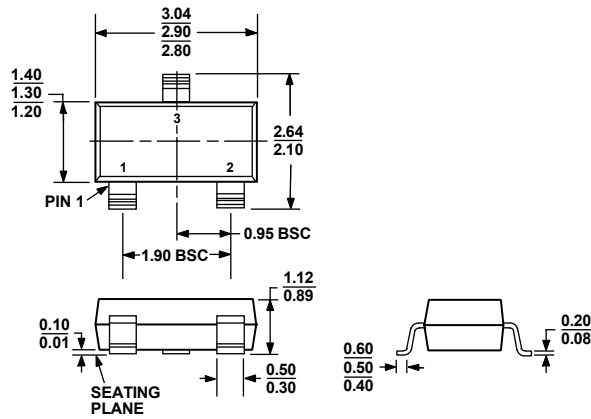

COMPLIANT TO JEDEC STANDARDS TO-236-AB

Figure 15. 3-Lead Small Outline Transistor Package [SOT-23-3] (RT-3)

Dimensions shown in millimeters

ORDERING GUIDE

Model	Output Voltage (V _{OUT})	Initial Accuracy		Temperature Coefficient	Temperature Range	Package Description	Package Option	Ordering Quantity	Branding
ADR510ART-REEL7	1.0 V	3.5 mV	0.35%	70 ppm/°C	-40°C to +85°C	3-Lead SOT-23-3	RT-3	3,000	RAA
ADR510ART-R2	1.0 V	3.5 mV	0.35%	70 ppm/°C	-40°C to +85°C	3-Lead SOT-23-3	RT-3	250	RAA
ADR510ARTZ-REEL7 ¹	1.0 V	3.5 mV	0.35%	70 ppm/°C	-40°C to +85°C	3-Lead SOT-23-3	RT-3	3,000	RAA#
ADR510ARTZ-R2 ¹	1.0 V	3.5 mV	0.35%	70 ppm/°C	-40°C to +85°C	3-Lead SOT-23-3	RT-3	250	RAA#

¹ Z = RoHS Compliant Part. # denotes lead free, may be top or bottom marked.

NOTES

ADR510

NOTES