

High Voltage Input Precision, Low Noise FGA™ Voltage References

The ISL21009 FGA™ voltage references are extremely low power, high precision, and low noise voltage references fabricated on Intersil's proprietary Floating Gate Analog technology. The ISL21009 features very low noise ($4.5\mu\text{V}_{\text{P-P}}$ for 0.1Hz to 10Hz), low operating current (180 μA , Max), and 3ppm/°C of temperature drift. In addition, the ISL21009 family features guaranteed initial accuracy as low as $\pm 0.5\text{mV}$.

This combination of high initial accuracy, low power and low output noise performance of the ISL21009 enables versatile high performance control and data acquisition applications with low power consumption.

Available Options

PART NUMBER	V _{OUT} OPTION (V)	INITIAL ACCURACY (mV)	TEMPCO. (ppm/°C)
ISL21009BFB812Z	1.250	± 0.5	3
ISL21009CFB812Z	1.250	± 1.0	5
ISL21009DFB812Z	1.250	± 2.0	10
ISL21009BFB825Z	2.500	± 0.5	3
ISL21009CFB825Z	2.500	± 1.0	5
ISL21009DFB825Z	2.500	± 2.0	10
ISL21009BFB841Z	4.096	± 0.5	3
ISL21009CFB841Z	4.096	± 1.0	5
ISL21009DFB841Z	4.096	± 2.0	10
ISL21009BFB850Z	5.000	± 0.5	3
ISL21009CFB850Z	5.000	± 1.0	5
ISL21009DFB850Z	5.000	± 2.0	10

Features

- Output Voltages 1.250V, 2.500V, 4.096V, 5.000V
- Initial Accuracy $\pm 0.5\text{mV}$, $\pm 1.0\text{mV}$, $\pm 2.0\text{mV}$
- Input Voltage Range 3.5V to 16.5V
- Output Voltage Noise $4.5\mu\text{V}_{\text{P-P}}$ (0.1Hz to 10Hz)
- Supply Current 180 μA (Max)
- Temperature Coefficient . . . 3ppm/°C, 5ppm/°C, 10ppm/°C
- Output Current Capability Up to $\pm 7.0\text{mA}$
- Operating Temperature Range -40°C to +125°C
- Package 8 Ld SOIC
- Pb-Free (RoHS Compliant)

Applications

- High Resolution A/Ds and D/As
- Digital Meters
- Bar Code Scanners
- Basestations
- Battery Management/Monitoring
- Industrial/Instrumentation Equipment

Pinout

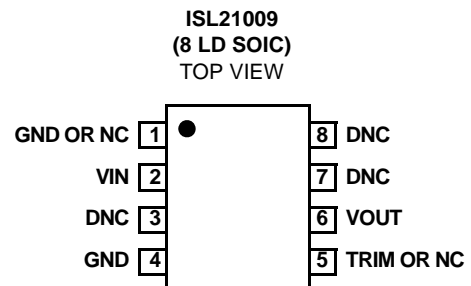

Pin Descriptions

PIN NUMBER	PIN NAME	DESCRIPTION
1	GND or NC	Can be either Ground or No Connect
2	VIN	Power Supply Input Connection
4	GND	Ground Connection
5	TRIM or NC	Allows user trim typically $\pm 2.5\%$. Leave Unconnected when unused.
6	VOUT	Voltage Reference Output Connection
3, 7, 8	DNC	Do Not Connect; Internal Connection – Must Be Left Floating

Ordering Information

PART NUMBER (Notes 1, 2)	PART MARKING	V _{OUT} OPTION (V)	GRADE	TEMP. RANGE (°C)	PACKAGE (Pb-Free)	PKG. DWG. #
ISL21009BFB812Z	21009BF Z12	1.250	$\pm 0.5\text{mV}$, 3ppm/°C	-40 to +125	8 Ld SOIC	M8.15
ISL21009CFB812Z	21009CF Z12	1.250	$\pm 1.0\text{mV}$, 5ppm/°C	-40 to +125	8 Ld SOIC	M8.15
ISL21009DFB812Z	21009DF Z12	1.250	$\pm 2.0\text{mV}$, 10ppm/°C	-40 to +125	8 Ld SOIC	M8.15
ISL21009BFB825Z	21009BF Z25	2.500	$\pm 0.5\text{mV}$, 3ppm/°C	-40 to +125	8 Ld SOIC	M8.15
ISL21009CFB825Z	21009CF Z25	2.500	$\pm 1.0\text{mV}$, 5ppm/°C	-40 to +125	8 Ld SOIC	M8.15
ISL21009DFB825Z	21009DF Z25	2.500	$\pm 2.0\text{mV}$, 10ppm/°C	-40 to +125	8 Ld SOIC	M8.15
ISL21009BFB841Z	21009BF Z41	4.096	$\pm 0.5\text{mV}$, 3ppm/°C	-40 to +125	8 Ld SOIC	M8.15
ISL21009CFB841Z	21009CF Z41	4.096	$\pm 1.0\text{mV}$, 5ppm/°C	-40 to +125	8 Ld SOIC	M8.15
ISL21009DFB841Z	21009DF Z41	4.096	$\pm 2.0\text{mV}$, 10ppm/°C	-40 to +125	8 Ld SOIC	M8.15
ISL21009BFB850Z	21009BF Z50	5.000	$\pm 0.5\text{mV}$, 3ppm/°C	-40 to +125	8 Ld SOIC	M8.15
ISL21009CFB850Z	21009CF Z50	5.000	$\pm 1.0\text{mV}$, 5ppm/°C	-40 to +125	8 Ld SOIC	M8.15
ISL21009DFB850Z	21009DF Z50	5.000	$\pm 2.0\text{mV}$, 10ppm/°C	-40 to +125	8 Ld SOIC	M8.15

NOTES:

- These Intersil Pb-free plastic packaged products employ special Pb-free material sets, molding compounds/die attach materials, and 100% matte tin plate plus anneal (e3 termination finish, which is RoHS compliant and compatible with both SnPb and Pb-free soldering operations). Intersil Pb-free products are MSL classified at Pb-free peak reflow temperatures that meet or exceed the Pb-free requirements of IPC/JEDEC J STD-020.
- Add "-TK" suffix for tape and reel. Please refer to TB347 for details on reel specifications.

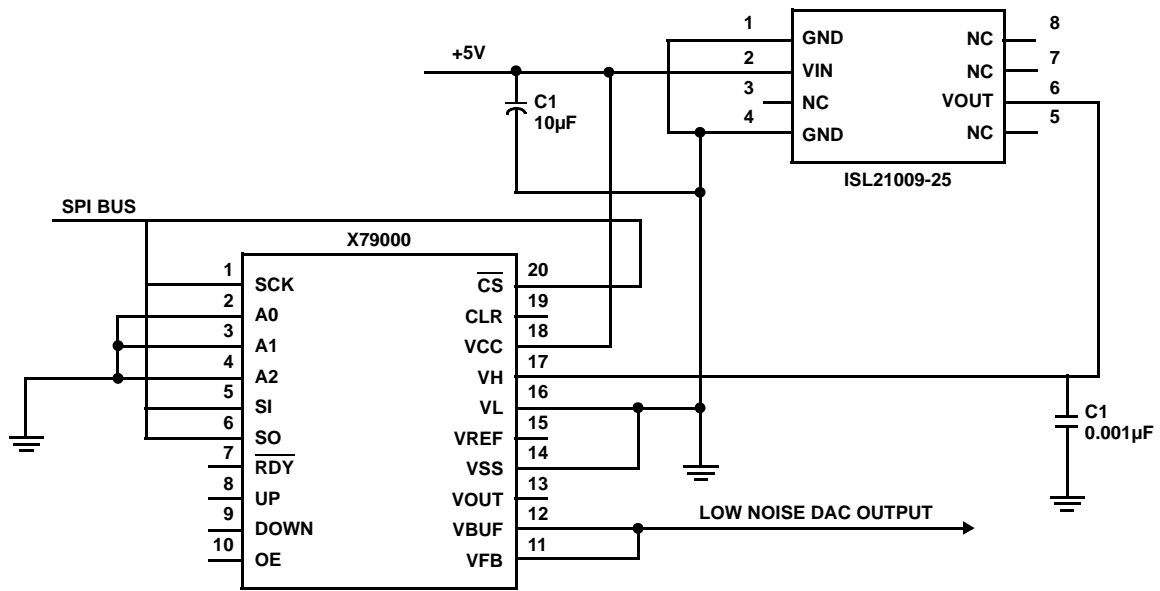

FIGURE 1. TYPICAL APPLICATION PRECISION 12-BIT SUB-RANGING DAC

Absolute Voltage Ratings

Max Voltage V_{IN} to GND -0.5V to +18V
 Max Voltage V_{OUT} to GND (10s) -0.5V to $V_{OUT} + 1V$
 Voltage on "DNC" pins No connections permitted to these pins.
 ESD Ratings
 Human Body Model 6kV
 Charged Device Model 2kV

Thermal Information

Thermal Resistance (Typical, Note 3) θ_{JA} (°C/W)
 8 Ld SOIC 115
 Storage Temperature Range -65°C to +150°C
 Pb-free Reflow Profile (Note 4). see link below
<http://www.intersil.com/pbfree/Pb-FreeReflow.asp>

Recommended Operating Conditions

Temperature Range (Industrial) -40°C to +125°C

CAUTION: Do not operate at or near the maximum ratings listed for extended periods of time. Exposure to such conditions may adversely impact product reliability and result in failures not covered by warranty.

IMPORTANT NOTE: All parameters having Min/Max specifications are guaranteed. Typ values are for information purposes only. Unless otherwise noted, all tests are at the specified temperature and are pulsed tests, therefore: $T_J = T_C = T_A$

NOTES:

3. θ_{JA} is measured with the component mounted on a high effective thermal conductivity test board in free air. See Tech Brief TB379 for details.
4. Post-reflow drift for the ISL21009 devices will range from 100µV to 1.0mV based on experimental results with devices tested in sockets and also on FR4 multi-layer PC boards. The design engineer must take this into account when considering the reference voltage after assembly.

Common Electrical Specifications (ISL21009-12, -25, -41, -50) $T_A = -40^\circ\text{C}$ to $+125^\circ\text{C}$, $I_{OUT} = 0$, unless otherwise specified.

PARAMETER	DESCRIPTION	CONDITIONS	MIN	TYP	MAX	UNIT
V_{OA}	V_{OUT} Accuracy @ $T_A = +25^\circ\text{C}$	ISL21009B	-0.5		+0.5	mV
		ISL21009C	-1.0		+1.0	mV
		ISL21009D	-2.0		+2.0	mV
TC V_{OUT}	Output Voltage Temperature Coefficient (Note 5)	ISL21009B			3	ppm/°C
		ISL21009C			5	ppm/°C
		ISL21009D			10	ppm/°C
I_{IN}	Supply Current			95	180	µA
$\Delta V_{OUT} / V_{OUT}$	Trim Range		±2.0	±2.5		%
I_{SC}	Short Circuit Current	$T_A = +25^\circ\text{C}$, V_{OUT} tied to GND		10		mA
t_R	Turn-on Settling Time	$V_{OUT} = \pm 0.1\%$		100		µs
	Ripple Rejection	$f = 10\text{kHz}$		60		dB
e_N	Output Voltage Noise	$0.1\text{Hz} \leq f \leq 10\text{Hz}$		4.5		µV _{P-P}
V_N	Broadband Voltage Noise	$10\text{Hz} \leq f \leq 1\text{kHz}$		2.2		µV _{RMS}

Electrical Specifications (ISL21009-12, $V_{OUT} = 1.250V$) $V_{IN} = 5.0V$, $T_A = -40^\circ\text{C}$ to $+125^\circ\text{C}$, $I_{OUT} = 0$, unless otherwise specified.

PARAMETER	DESCRIPTION	CONDITIONS	MIN	TYP	MAX	UNIT
V_{OUT}	Output Voltage			1.250		V
V_{IN}	Input Voltage Range		3.5		16.5	V
$\Delta V_{OUT} / \Delta V_{IN}$	Line Regulation	$3.5V \leq V_{IN} \leq 5.5V$		50	150	µV/V
		$5.5V \leq V_{IN} \leq 16.5V$		10	50	µV/V
$\Delta V_{OUT} / \Delta I_{OUT}$	Load Regulation	Sourcing: $0\text{mA} \leq I_{OUT} \leq 7\text{mA}$		10	50	µV/mA
		Sinking: $-7\text{mA} \leq I_{OUT} \leq 0\text{mA}$		20	100	µV/mA
$\Delta V_{OUT} / \Delta T_A$	Thermal Hysteresis (Note 6)	$\Delta T_A = +165^\circ\text{C}$		50		ppm
$\Delta V_{OUT} / \Delta t$	Long Term Stability (Note 7)	$T_A = +25^\circ\text{C}$		50		ppm

ISL21009

Electrical Specifications (ISL21009-25, $V_{OUT} = 2.50V$) $V_{IN} = 5.0V$, $T_A = -40^{\circ}C$ to $+125^{\circ}C$, $I_{OUT} = 0$, unless otherwise specified.

PARAMETER	DESCRIPTION	CONDITIONS	MIN	TYP	MAX	UNIT
V_{OUT}	Output Voltage			2.500		V
V_{IN}	Input Voltage Range		3.5		16.5	V
$\Delta V_{OUT}/\Delta V_{IN}$	Line Regulation	$3.5V \leq V_{IN} \leq 5.5V$		50	150	$\mu V/V$
		$5.5V \leq V_{IN} \leq 16.5V$		10	50	$\mu V/V$
$\Delta V_{OUT}/\Delta I_{OUT}$	Load Regulation	Sourcing: $0mA \leq I_{OUT} \leq 7mA$		10	50	$\mu V/mA$
		Sinking: $-7mA \leq I_{OUT} \leq 0mA$		20	100	$\mu V/mA$
$\Delta V_{OUT}/\Delta T_A$	Thermal Hysteresis (Note 6)	$\Delta T_A = +165^{\circ}C$		50		ppm
$\Delta V_{OUT}/\Delta t$	Long Term Stability (Note 7)	$T_A = +25^{\circ}C$		50		ppm

Electrical Specifications (ISL21009-41, $V_{OUT} = 4.096V$) $V_{IN} = 5.0V$, $T_A = -40^{\circ}C$ to $+125^{\circ}C$, $I_{OUT} = 0$ unless otherwise specified.

PARAMETER	DESCRIPTION	CONDITIONS	MIN	TYP	MAX	UNIT
V_{OUT}	Output Voltage			4.096		V
V_{IN}	Input Voltage Range		4.5		16.5	V
$\Delta V_{OUT}/\Delta V_{IN}$	Line Regulation	$4.5V \leq V_{IN} \leq 16.5V$		50	200	$\mu V/V$
$\Delta V_{OUT}/\Delta I_{OUT}$	Load Regulation	Sourcing: $0mA \leq I_{OUT} \leq 5mA$		20	100	$\mu V/mA$
		Sinking: $-5mA \leq I_{OUT} \leq 0mA$		20	150	$\mu V/mA$
$\Delta V_{OUT}/\Delta T_A$	Thermal Hysteresis (Note 6)	$\Delta T_A = +165^{\circ}C$		50		ppm
$\Delta V_{OUT}/\Delta t$	Long Term Stability (Note 7)	$T_A = +25^{\circ}C$		50		ppm

Electrical Specifications (ISL21009-50, $V_{OUT} = 5.0V$) $V_{IN} = 10.0V$, $T_A = -40^{\circ}C$ to $+125^{\circ}C$, $I_{OUT} = 0$ unless otherwise specified.

PARAMETER	DESCRIPTION	CONDITIONS	MIN	TYP	MAX	UNIT
V_{OUT}	Output Voltage			5.000		V
V_{IN}	Input Voltage Range		5.5		16.5	V
$\Delta V_{OUT}/\Delta V_{IN}$	Line Regulation	$5.5V \leq V_{IN} \leq 16.5V$		20	90	$\mu V/V$
$\Delta V_{OUT}/\Delta I_{OUT}$	Load Regulation	Sourcing: $0mA \leq I_{OUT} \leq 7mA$		10	100	$\mu V/mA$
		Sinking: $-7mA \leq I_{OUT} \leq 0mA$		20	150	$\mu V/mA$
$\Delta V_{OUT}/\Delta T_A$	Thermal Hysteresis (Note 6)	$\Delta T_A = +165^{\circ}C$		50		ppm
$\Delta V_{OUT}/\Delta t$	Long Term Stability (Note 7)	$T_A = +25^{\circ}C$		50		ppm

NOTES:

- Over the specified temperature range. Temperature coefficient is measured by the box method whereby the change in V_{OUT} is divided by the temperature range; in this case, $-40^{\circ}C$ to $+125^{\circ}C = +165^{\circ}C$.
- Thermal Hysteresis is the change of V_{OUT} measured @ $T_A = +25^{\circ}C$ after temperature cycling over a specified range, ΔT_A . V_{OUT} is read initially at $T_A = +25^{\circ}C$ for the device under test. The device is temperature cycled and a second V_{OUT} measurement is taken at $+25^{\circ}C$. The difference between the initial V_{OUT} reading and the second V_{OUT} reading is then expressed in ppm. For $\Delta T_A = +165^{\circ}C$, the device under test is cycled from $+25^{\circ}C$ to $+125^{\circ}C$ to $-40^{\circ}C$ to $+25^{\circ}C$.
- Long term drift is logarithmic in nature and diminishes over time. Drift after the first 1000 hours will be approximately $10ppm/\sqrt{(1kHrs)}$.

Typical Performance Curves (ISL21009-12) ($R_{EXT} = 100k\Omega$)

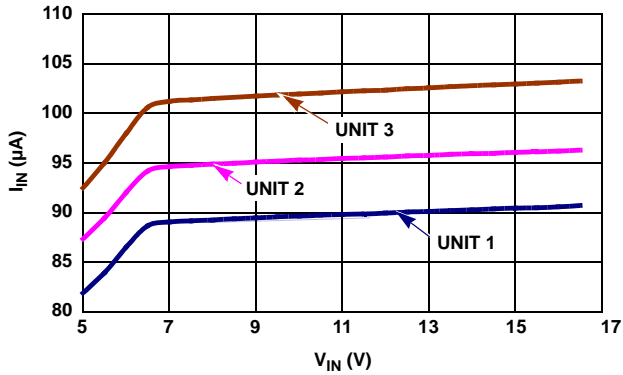

FIGURE 2. I_{IN} vs V_{IN} , 3 UNITS

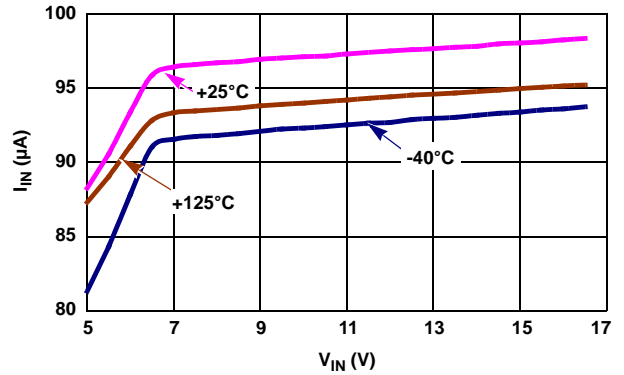

FIGURE 3. I_{IN} vs V_{IN} , 3 TEMPERATURES

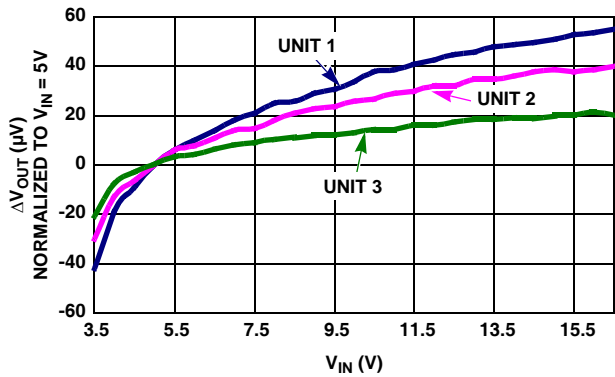

FIGURE 4. LINE REGULATION, 3 UNITS

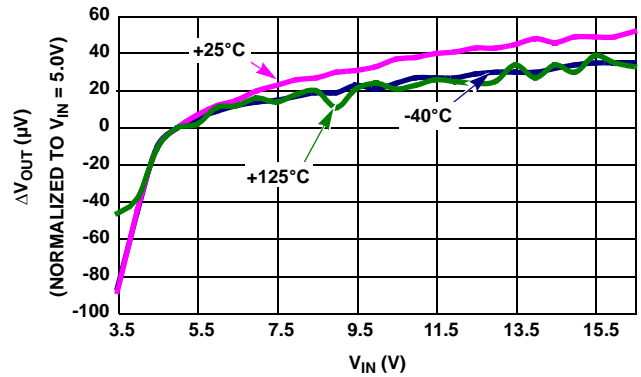

FIGURE 5. LINE REGULATION OVER-TEMPERATURE

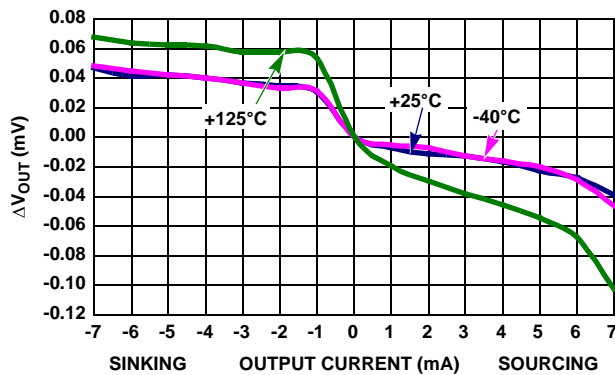

FIGURE 6. LOAD REGULATION

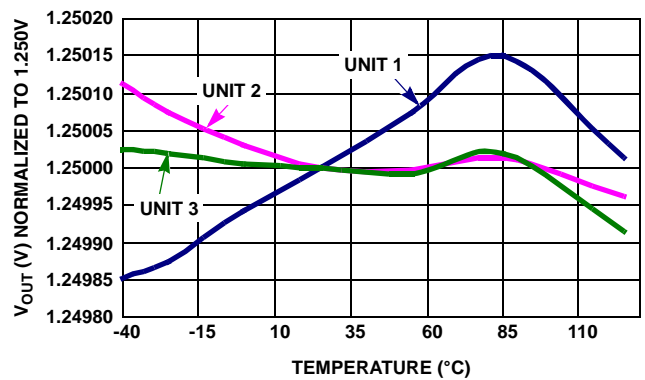

FIGURE 7. V_{OUT} vs TEMPERATURE, 3 UNITS

Typical Performance Curves (ISL21009-12) ($R_{EXT} = 100k\Omega$) (Continued)

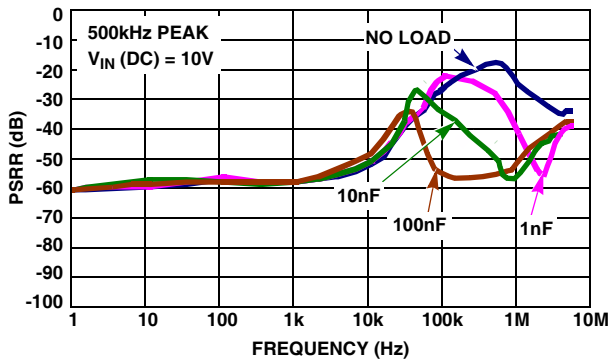

FIGURE 8. PSRR AT DIFFERENT CAPACITIVE LOADS

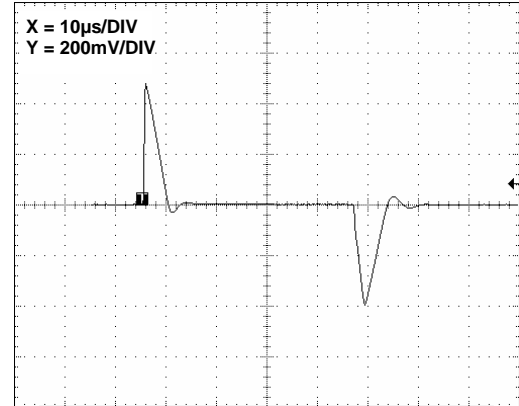

FIGURE 9. LINE TRANSIENT RESPONSE, NO CAPACITIVE LOAD

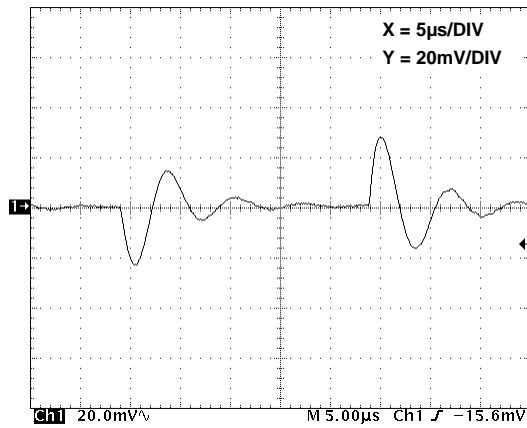

FIGURE 10. LINE TRANSIENT RESPONSE, $0.001\mu F$ LOAD CAPACITANCE

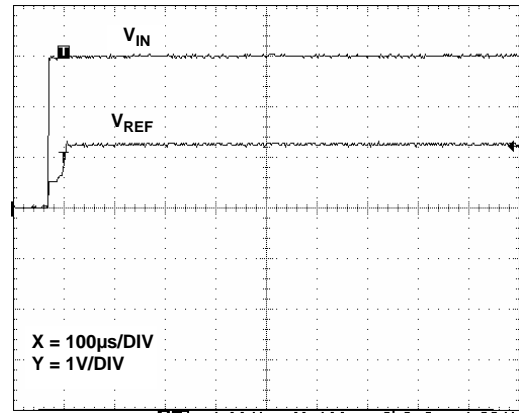

FIGURE 11. TURN-ON TIME

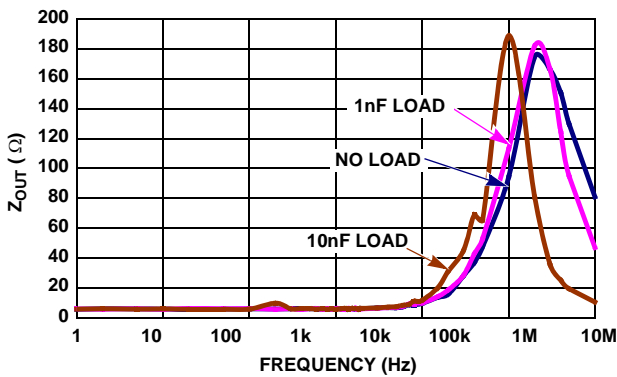

FIGURE 12. Z_{OUT} vs FREQUENCY

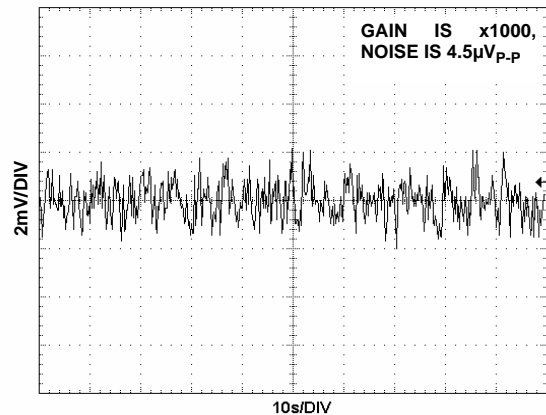

FIGURE 13. V_{OUT} NOISE, 0.1Hz TO 10Hz

Typical Performance Curves (ISL21009-12) ($R_{EXT} = 100k\Omega$) (Continued)

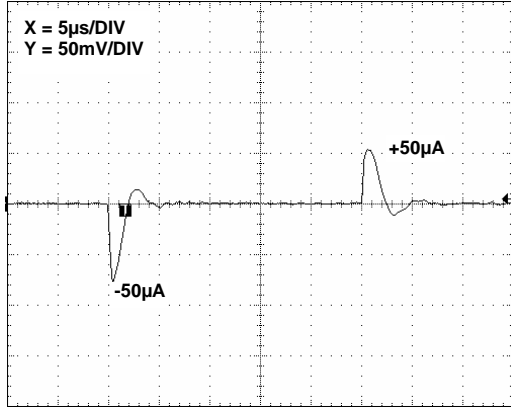

FIGURE 14. LOAD TRANSIENT RESPONSE

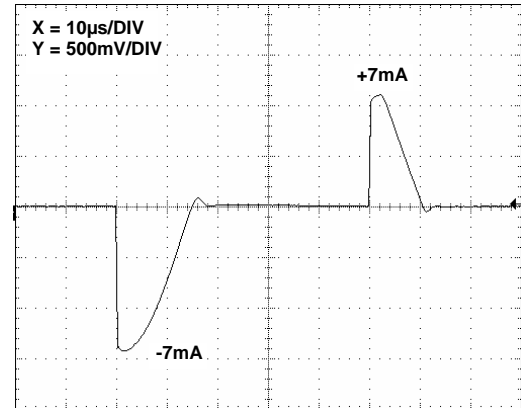

FIGURE 15. LOAD TRANSIENT RESPONSE

Typical Performance Curves (ISL21009-25) ($R_{EXT} = 100k\Omega$)

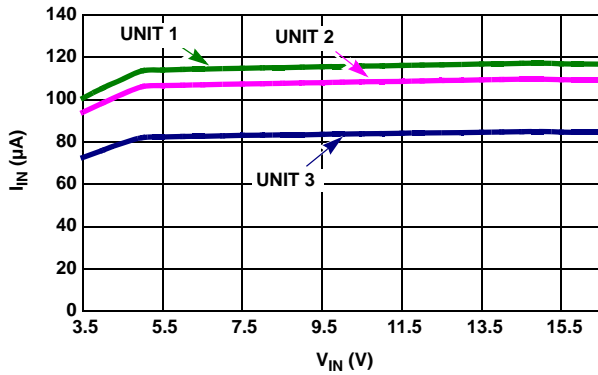

FIGURE 16. I_{IN} vs V_{IN} , 3 UNITS

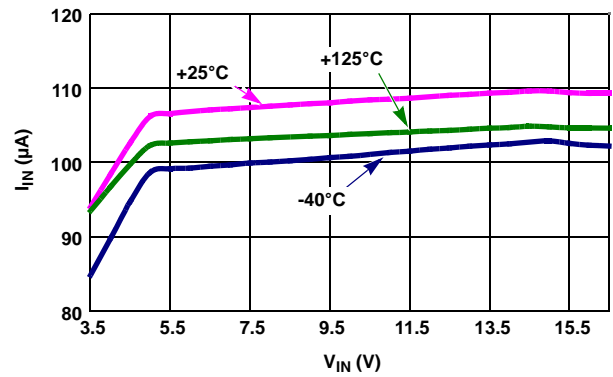

FIGURE 17. I_{IN} vs V_{IN} , 3 TEMPERATURES

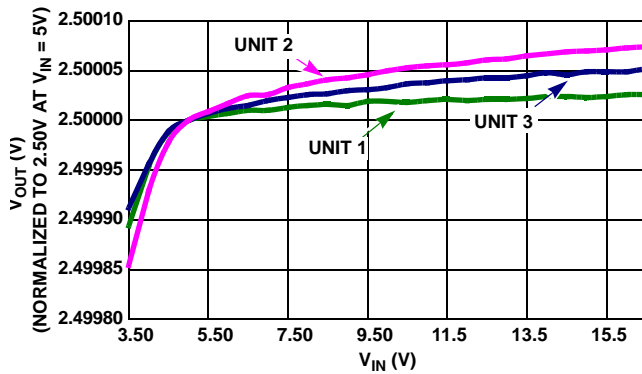

FIGURE 18. LINE REGULATION

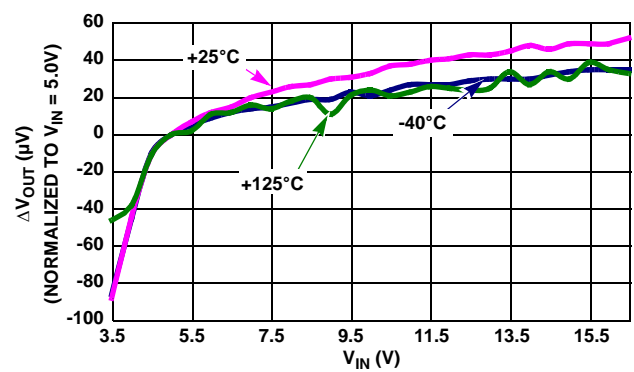

FIGURE 19. LINE REGULATION OVER-TEMPERATURE

Typical Performance Curves (ISL21009-25) ($R_{EXT} = 100k\Omega$) (Continued)

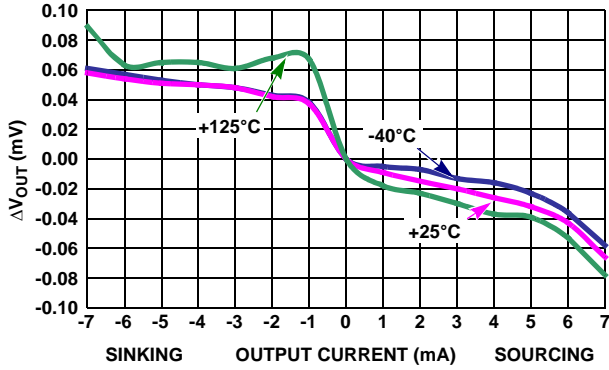

FIGURE 20. LOAD REGULATION

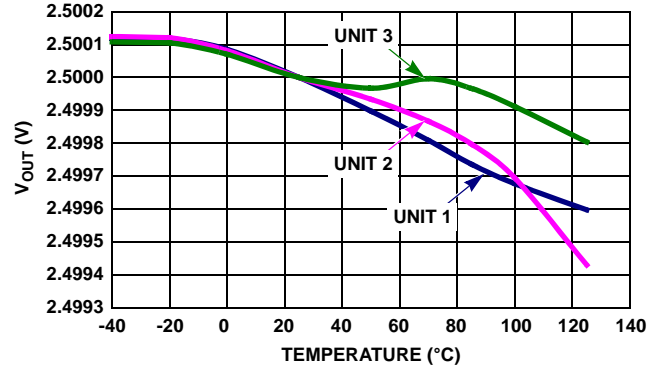

FIGURE 21. V_{OUT} vs TEMPERATURE

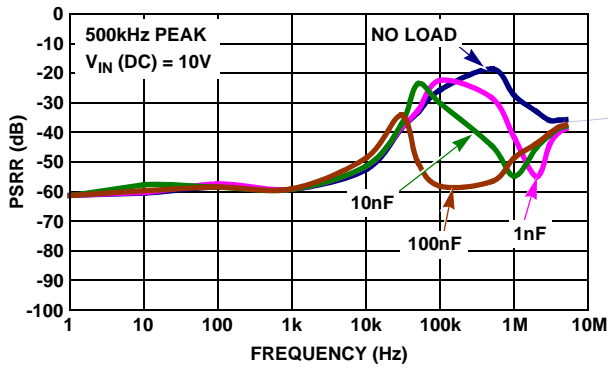

FIGURE 22. PSRR AT DIFFERENT CAPACITIVE LOADS

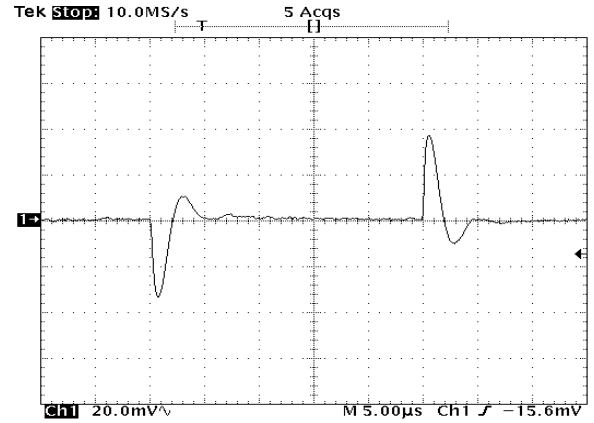

FIGURE 23. LINE TRANSIENT RESPONSE, NO CAPACITIVE LOAD

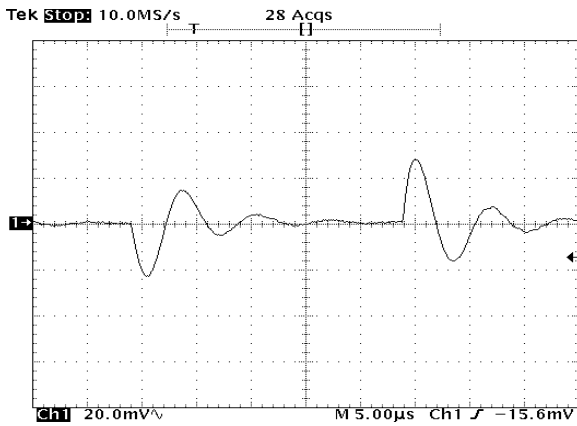

FIGURE 24. LINE TRANSIENT RESPONSE, 0.001 μ F LOAD CAPACITANCE

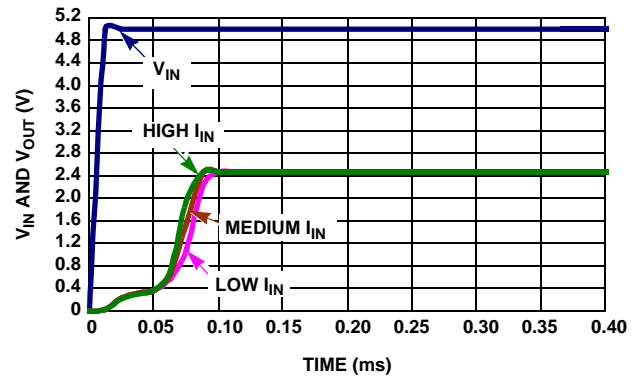

FIGURE 25. TURN-ON TIME

Typical Performance Curves (ISL21009-25) ($R_{EXT} = 100k\Omega$) (Continued)

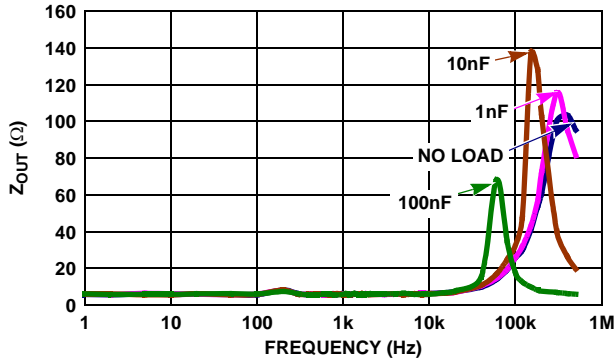

FIGURE 26. Z_{OUT} vs FREQUENCY

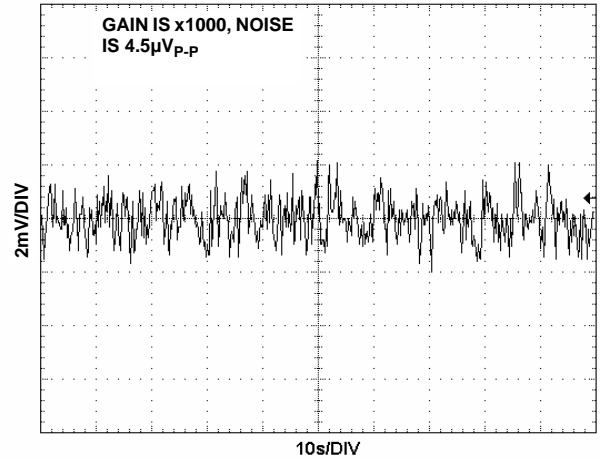

FIGURE 27. V_{OUT} NOISE, 0.1Hz TO 10Hz

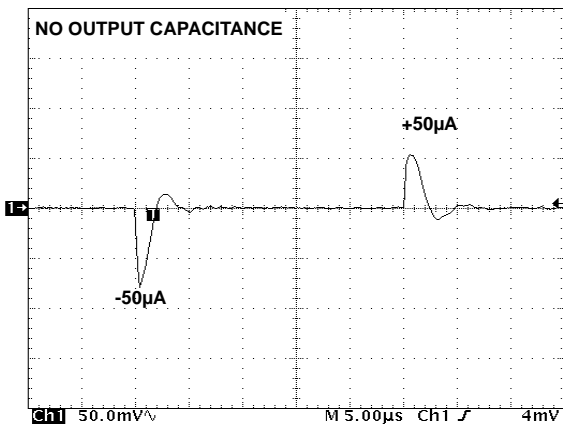

FIGURE 28. LOAD TRANSIENT RESPONSE

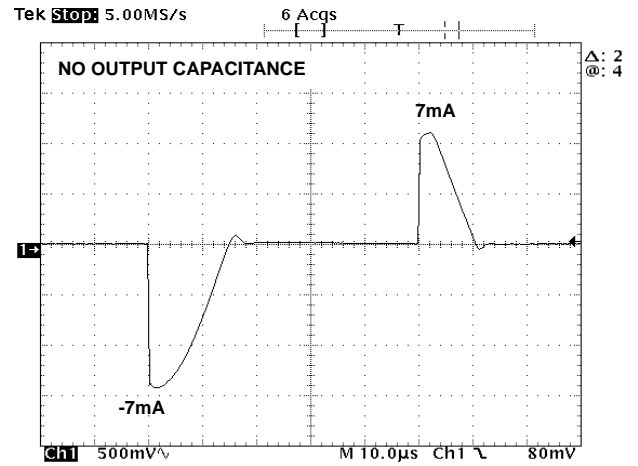

FIGURE 29. LOAD TRANSIENT RESPONSE

Typical Performance Curves (ISL21009-41) ($R_{EXT} = 100k\Omega$)

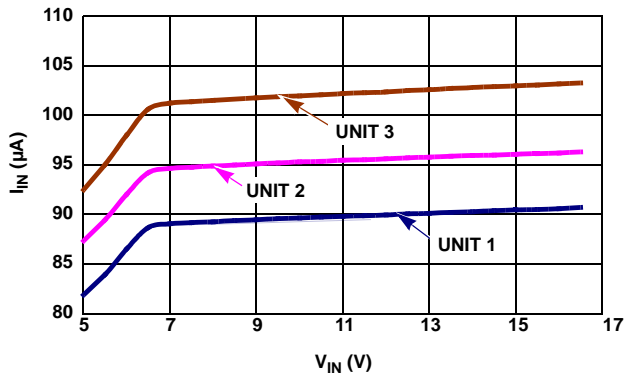

FIGURE 30. I_{IN} vs V_{IN} , 3 UNITS

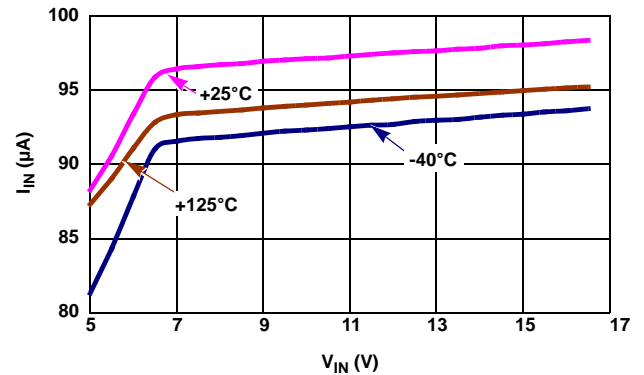

FIGURE 31. I_{IN} vs V_{IN} , 3 TEMPERATURES

Typical Performance Curves (ISL21009-41) ($R_{EXT} = 100k\Omega$) (Continued)

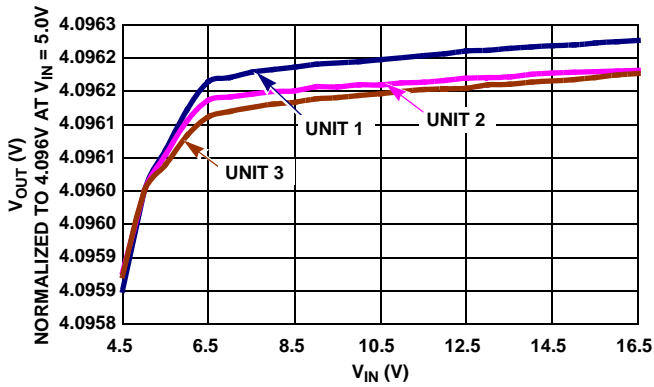

FIGURE 32. LINE REGULATION, 3 UNITS

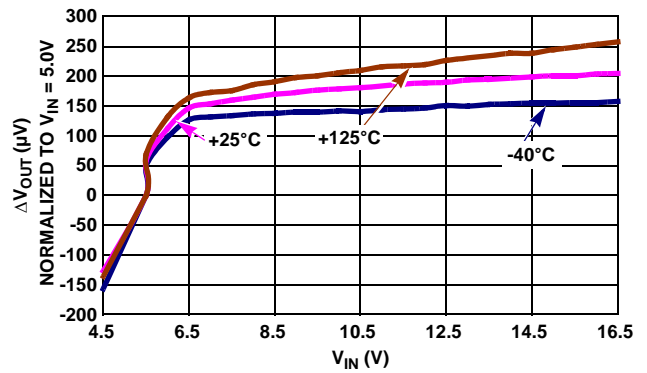

FIGURE 33. LINE REGULATION OVER-TEMPERATURE

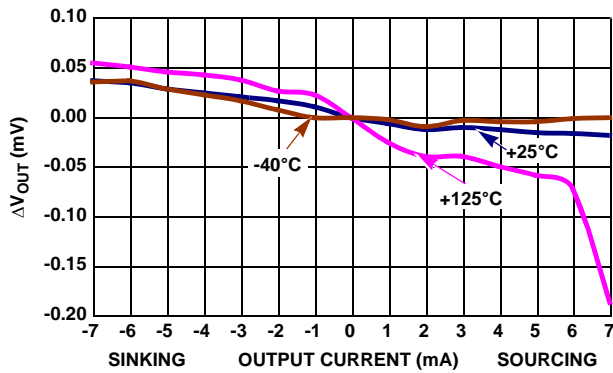

FIGURE 34. LOAD REGULATION

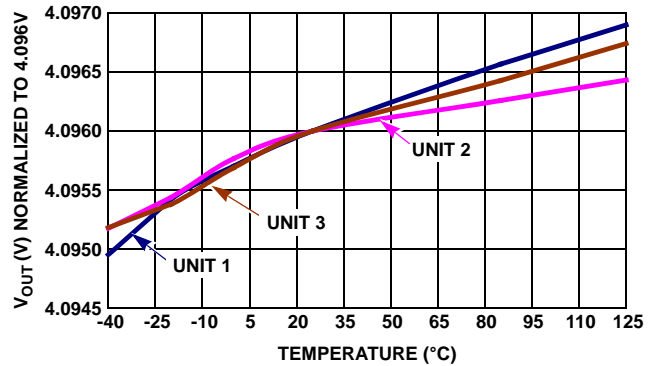

FIGURE 35. V_{OUT} vs TEMPERATURE

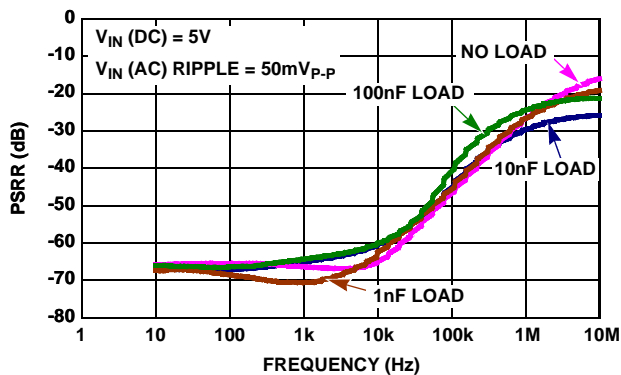

FIGURE 36. PSRR AT DIFFERENT CAPACITIVE LOADS

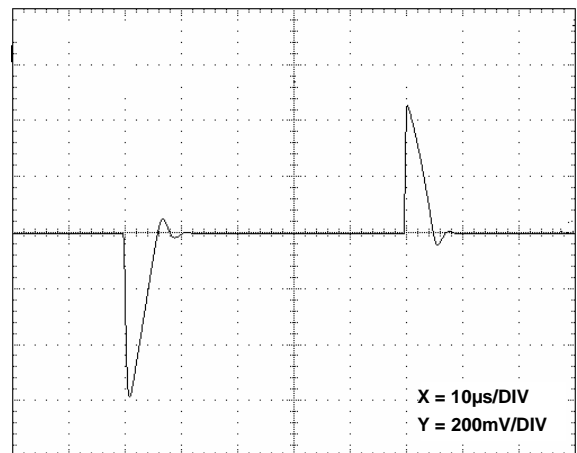

FIGURE 37. LINE TRANSIENT RESPONSE, NO CAPACITIVE LOAD

Typical Performance Curves (ISL21009-41) ($R_{EXT} = 100k\Omega$) (Continued)

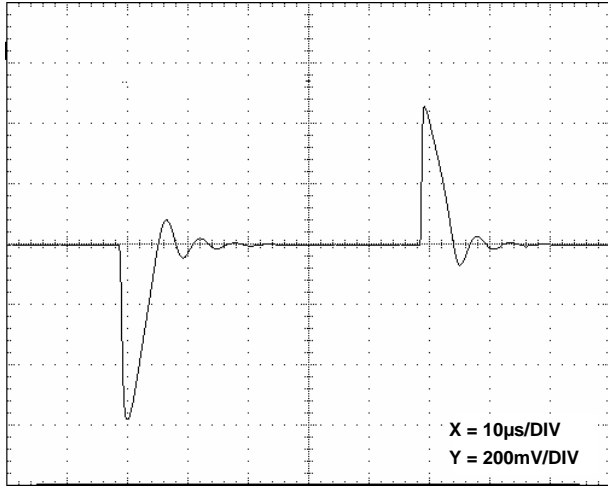

FIGURE 38. LINE TRANSIENT RESPONSE, 0.001µF LOAD CAPACITANCE

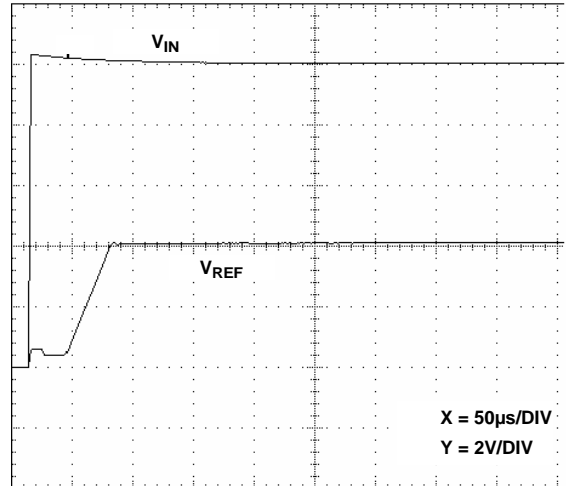

FIGURE 39. TURN-ON TIME

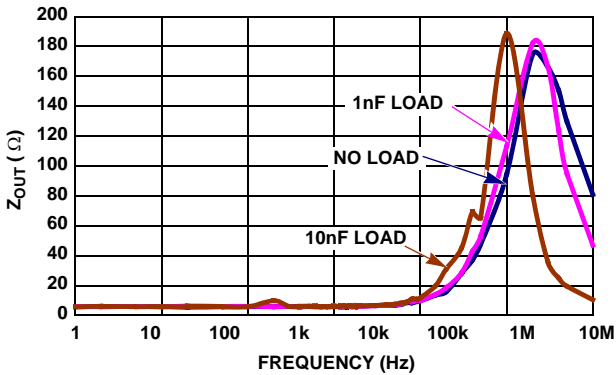

FIGURE 40. Z_{OUT} vs FREQUENCY

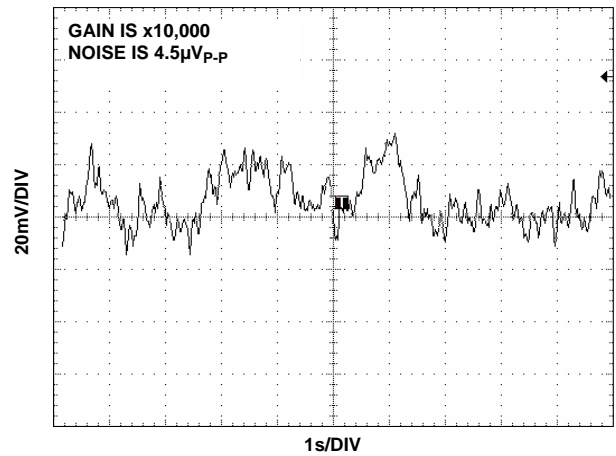

FIGURE 41. V_{OUT} NOISE, 0.1Hz TO 10Hz

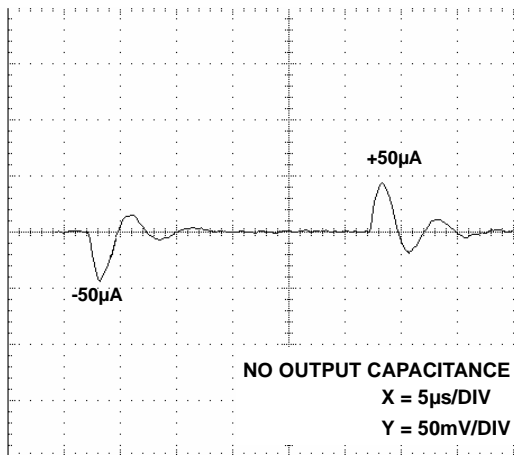

FIGURE 42. LOAD TRANSIENT RESPONSE

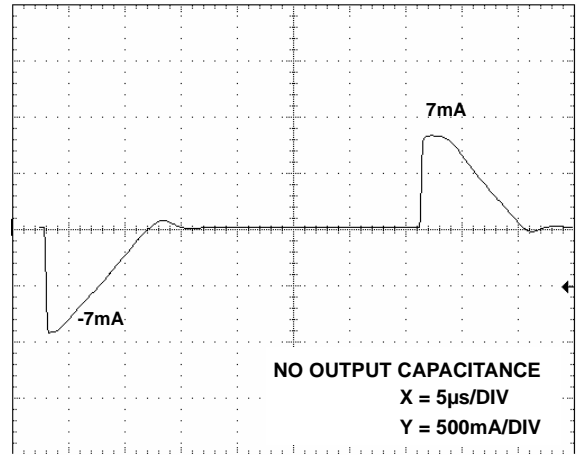

FIGURE 43. LOAD TRANSIENT RESPONSE

Typical Performance Curves (ISL21009-50) ($R_{EXT} = 100k\Omega$)

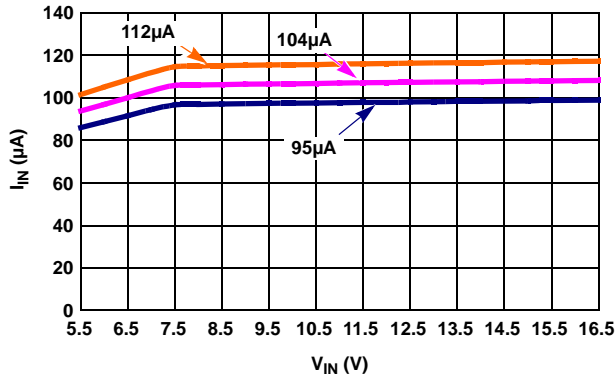

FIGURE 44. I_{IN} vs V_{IN} , 3 UNITS

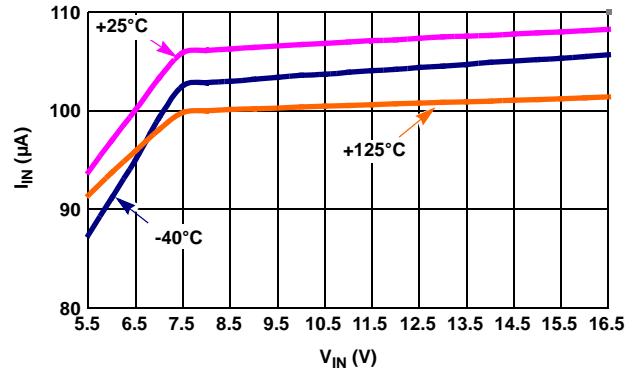

FIGURE 45. I_{IN} vs V_{IN} , 3 TEMPERATURES

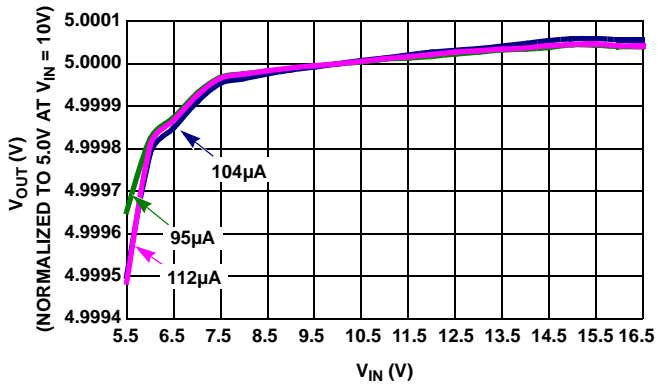

FIGURE 46. LINE REGULATION

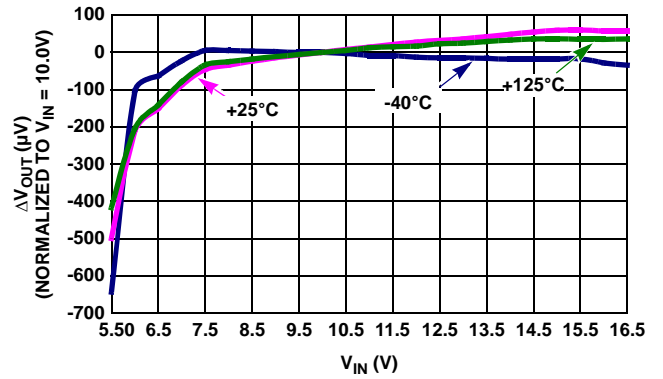

FIGURE 47. LINE REGULATION OVER-TEMPERATURE

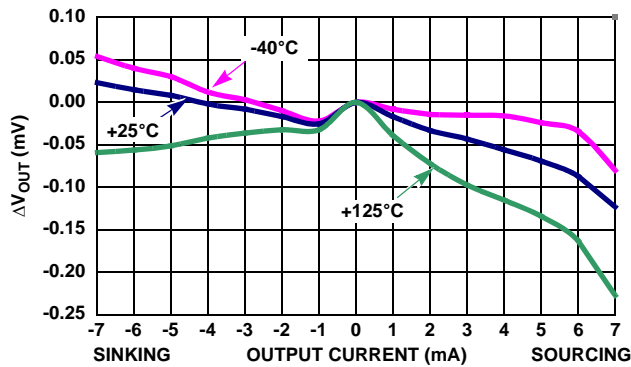

FIGURE 48. LOAD REGULATION

Typical Performance Curves (ISL21009-50) ($R_{EXT} = 100k\Omega$) (Continued)

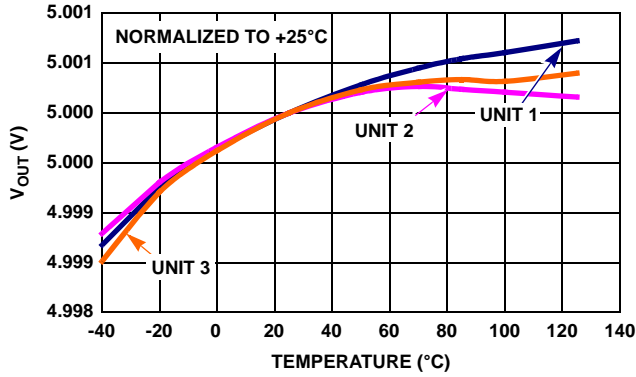

FIGURE 49. V_{OUT} vs TEMPERATURE

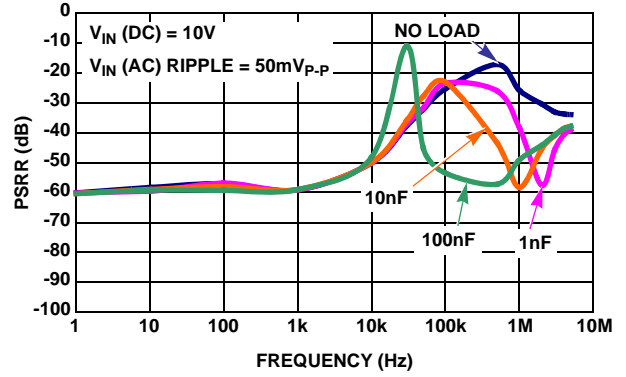

FIGURE 50. PSRR AT DIFFERENT CAPACITIVE LOADS

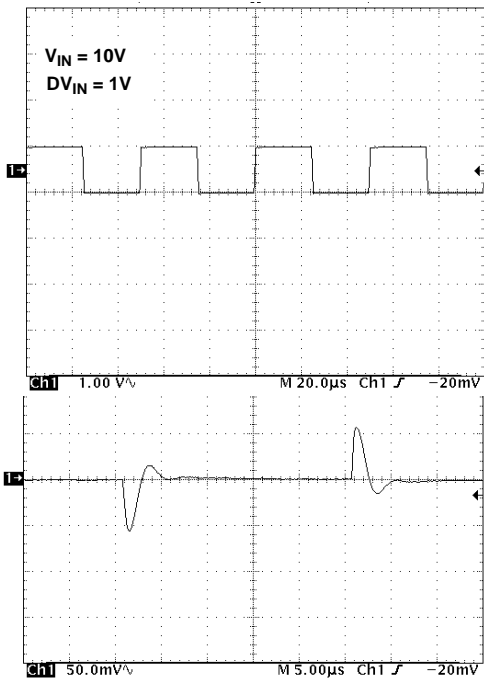

FIGURE 51. LINE TRANSIENT RESPONSE, NO CAPACITIVE LOAD

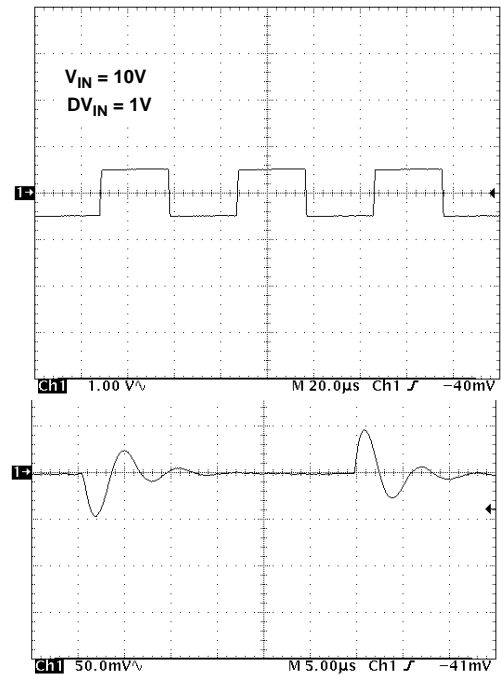

FIGURE 52. LINE TRANSIENT RESPONSE, 0.001 μ F LOAD CAPACITANCE

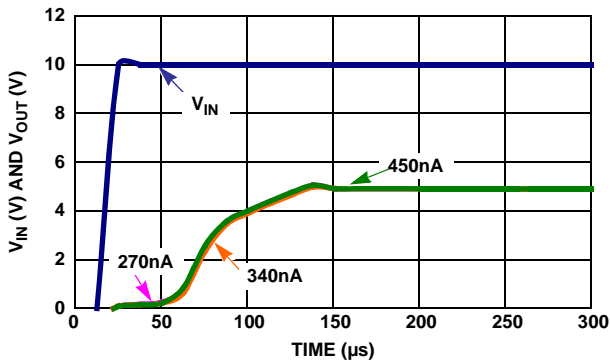

FIGURE 53. TURN-ON TIME

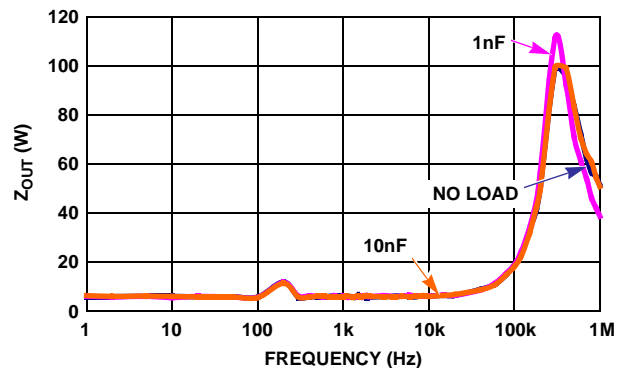
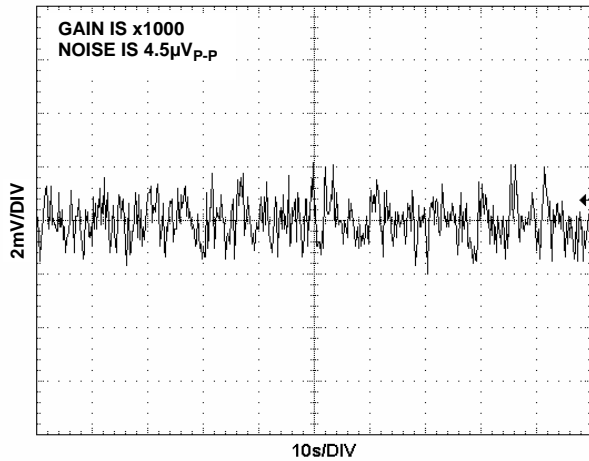
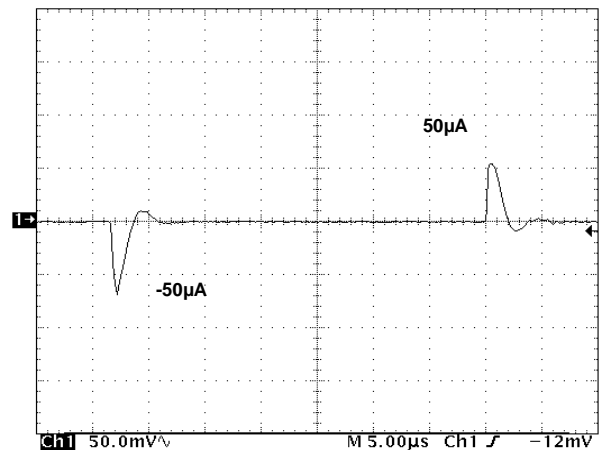
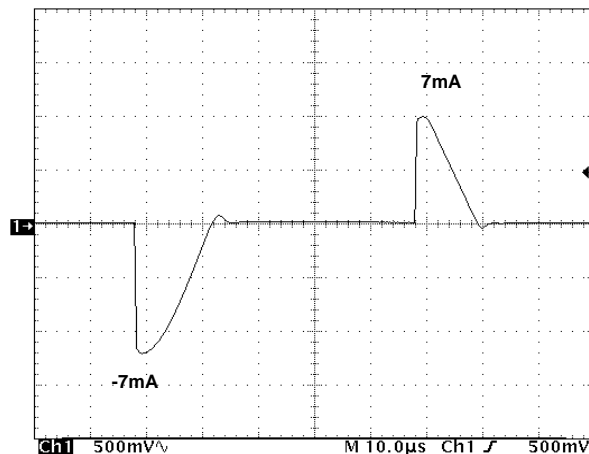

FIGURE 54. Z_{OUT} vs FREQUENCY

Typical Performance Curves (ISL21009-50) ($R_{EXT} = 100k\Omega$) (Continued)

FIGURE 55. V_{OUT} NOISE, 0.1Hz TO 10Hz

FIGURE 56. LOAD TRANSIENT RESPONSE

FIGURE 57. LOAD TRANSIENT RESPONSE

Applications Information

FGA Technology

The ISL21009 voltage reference uses floating gate technology to create references with very low drift and supply current. Essentially the charge stored on a floating gate cell is set precisely in manufacturing. The reference voltage output itself is a buffered version of the floating gate voltage. The resulting reference device has excellent characteristics, which are unique in the industry: very low temperature drift, high initial accuracy, and almost zero supply current. Also, the reference voltage itself is not limited by voltage bandgaps or zener settings, so a wide range of reference voltages can be programmed (standard voltage settings are provided, but customer-specific voltages are available).

The process used for these reference devices is a floating gate CMOS process and the amplifier circuitry uses CMOS transistors for amplifier and output transistor circuitry. While providing excellent accuracy, there are limitations in output noise level and load regulation, due to the MOS device characteristics. These limitations are addressed with circuit techniques discussed in other sections.

Micropower Operation

The ISL21009 consumes extremely low supply current due to the proprietary FGA technology. Low noise performance is achieved using optimized biasing techniques. Supply current is typically $95\mu A$ and noise is $4.5\mu V_{p-p}$ benefiting precision, low noise portable applications such as handheld meters and instruments.

Data Converters in particular can utilize the ISL21009 as an external voltage reference. Low power DAC and ADC circuits will realize maximum resolution with lowest noise.

Board Mounting Considerations

For applications requiring the highest accuracy, board mounting location should be reviewed. The device uses a plastic SOIC package, which will subject the die to mild stresses when the Printed Circuit (PC) board is heated and cooled, slightly changing the shape. Placing the device in areas subject to slight twisting can cause degradation of the accuracy of the reference voltage due to these die stresses. It is normally best to place the device near the edge of a board, or the shortest side, as the axis of bending is most limited at that location. Mounting the device in a cutout also minimizes flex. Obviously mounting the device on flexprint or extremely thin PC material will likewise cause loss of reference accuracy.

Board Assembly Considerations

FGA references provide high accuracy and low temperature drift but some PC board assembly precautions are necessary. Normal Output voltage shifts of 100 μ V to 1mV can be expected with Pb-free reflow profiles or wave solder on multi-layer FR4 PC boards. Precautions should be taken to avoid excessive heat or extended exposure to high reflow or wave solder temperatures, this may reduce device initial accuracy.

Post-assembly x-ray inspection may also lead to permanent changes in device output voltage and should be minimized or avoided. If x-ray inspection is required, it is advisable to monitor the reference output voltage to verify excessive shift has not occurred. If large amounts of shift are observed, it is best to add an X-ray shield consisting of thin zinc (300 μ m) sheeting to allow clear imaging, yet block x-ray energy that affects the FGA reference.

Special Applications Considerations

In addition to post-assembly examination, there are also other X-ray sources that may affect the FGA reference long term accuracy. Airport screening machines contain X-rays and will have a cumulative effect on the voltage reference output accuracy. Carry-on luggage screening uses low level X-rays and is not a major source of output voltage shift, although if a product is expected to pass through that type of screening over 100 times it may need to consider shielding with copper or aluminum. Checked luggage X-rays are higher intensity and can cause output voltage shift in much fewer passes, so devices expected to go through those machines should definitely consider shielding. Note that just two layers of 1/2 ounce copper planes will reduce the received dose by over 90%. The leadframe for the device which is on the bottom also provides similar shielding.

If a device is expected to pass through luggage X-ray machines numerous times, it is advised to mount a 2-layer (minimum) PC board on the top, and along with a ground

plane underneath will effectively shield it from from 50 to 100 passes through the machine. Since these machines vary in X-ray dose delivered, it is difficult to produce an accurate maximum pass recommendation.

Noise Performance and Reduction

The output noise voltage in a 0.1Hz to 10Hz bandwidth is typically 4.5 μ V_{P-P}. The noise measurement is made with a bandpass filter made of a 1-pole high-pass filter with a corner frequency at 0.1Hz and a 2-pole low-pass filter with a corner frequency (3dB) at 8.2Hz to create a filter with a 9.9Hz bandwidth. Noise in the 10Hz to 1kHz bandwidth is approximately 2.2 μ V_{P-P} with no capacitance on the output. This noise measurement is made with a 2 decade bandpass filter made of a 1-pole high-pass filter with a corner frequency at 1/10 of the center frequency and 1-pole low-pass filter with a corner frequency at 10x the center frequency. Load capacitance up to 1000pF can be added but will result in only marginal improvements in output noise and transient response.

The output stage of the ISL21009 does not drive heavily capacitive loads well, so for load capacitances above 0.001 μ F, the noise reduction network shown in Figure 58 is recommended. This network reduces noise significantly over the full bandwidth. Noise is reduced to less than 15 μ V_{P-P} from 1Hz to 1kHz using this network with a 0.01 μ F capacitor and a 2k Ω resistor in series with a 10 μ F capacitor. Also, transient response is improved. The 0.01 μ F value can be increased for better load transient response with little sacrifice in output stability.

Higher output capacitor values can be used without the RC network to address transient loads without stability problems, although there will be more overshoot and longer settling times with values up to 1.0 μ F. Output capacitor values greater than 1.0 μ F are not recommended for the ISL21009.

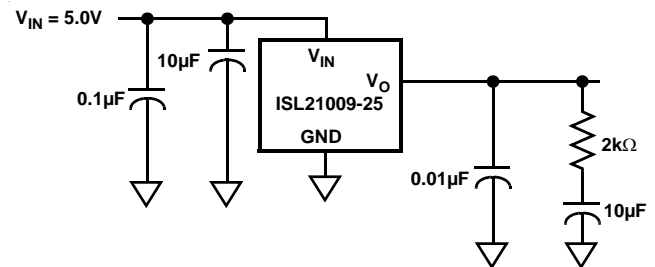

FIGURE 58. HANDLING HIGH LOAD CAPACITANCE

Turn-On Time

The ISL21009 devices have low supply current and thus, the time to bias up internal circuitry to final values will be longer than with higher power references. Normal turn-on time is typically 100 μ s, as shown in Figure 25. Circuit design must take this into account when looking at power-up delays or sequencing.

Temperature Coefficient

The limits stated for temperature coefficient (tempco) are governed by the method of measurement. The overwhelming standard for specifying the temperature drift of a reference is to measure the reference voltage at two temperatures, take the total variation, ($V_{HIGH} - V_{LOW}$), and divide by the temperature extremes of measurement ($T_{HIGH} - T_{LOW}$). The result is divided by the nominal reference voltage (at $T = +25^{\circ}\text{C}$) and multiplied by 10^6 to yield ppm/ $^{\circ}\text{C}$. This is the "Box" method for specifying temperature coefficient.

Typical Application Circuits

Output Voltage Adjustment

The output voltage can be adjusted up or down by 2.5% by placing a potentiometer from V_{OUT} to GND and connecting the wiper to the TRIM pin. The TRIM input is high impedance so no series resistance is needed. The resistor in the potentiometer should be a low tempco ($<50\text{ppm}/^{\circ}\text{C}$) and the resulting voltage divider should have very low tempco $<5\text{ppm}/^{\circ}\text{C}$. A digital potentiometer such as the ISL95810 provides a low tempco resistance and excellent resistor and tempco matching for trim applications.

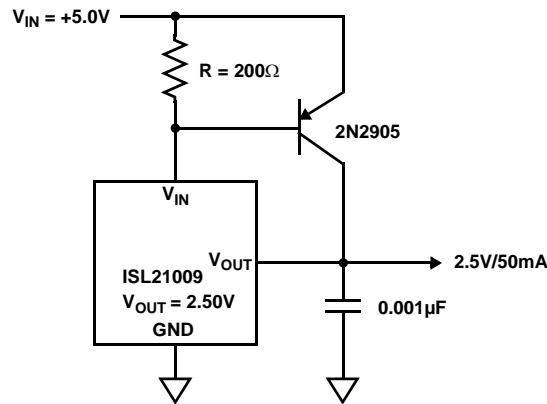

FIGURE 59. PRECISION 2.5V, 50mA REFERENCE

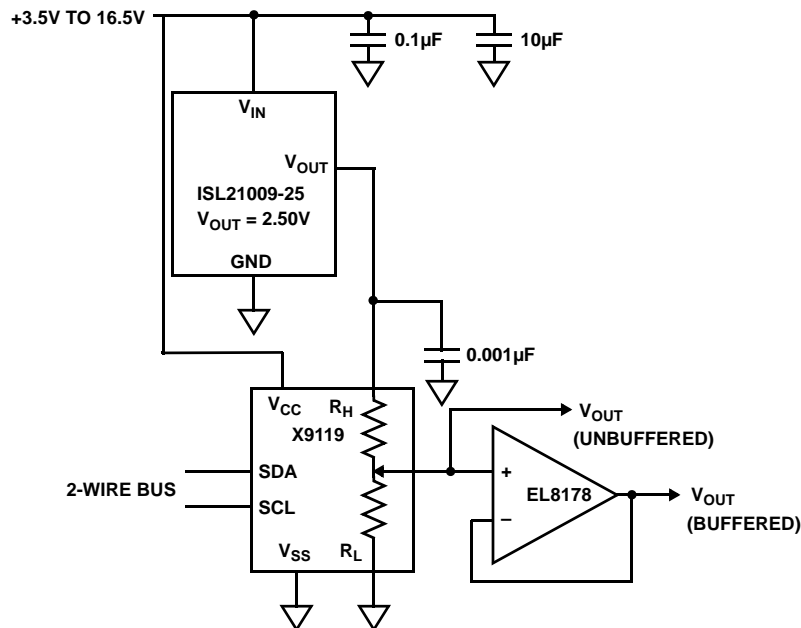

FIGURE 60. 2.5V FULL SCALE LOW-DRIFT, LOW NOISE, 10-BIT ADJUSTABLE VOLTAGE SOURCE

Typical Application Circuits (Continued)

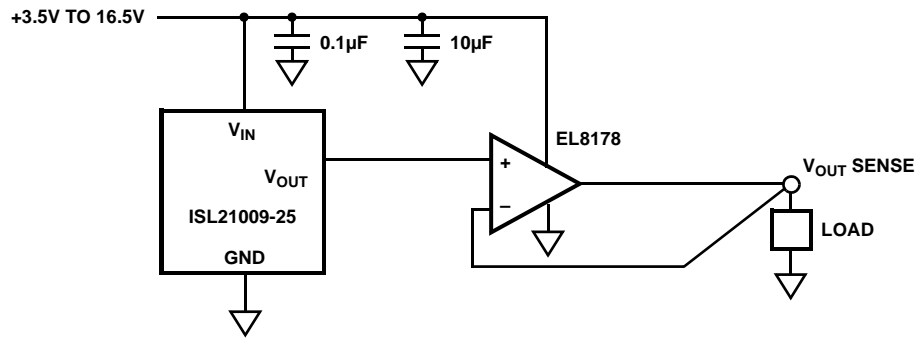

FIGURE 61. KELVIN SENSED LOAD

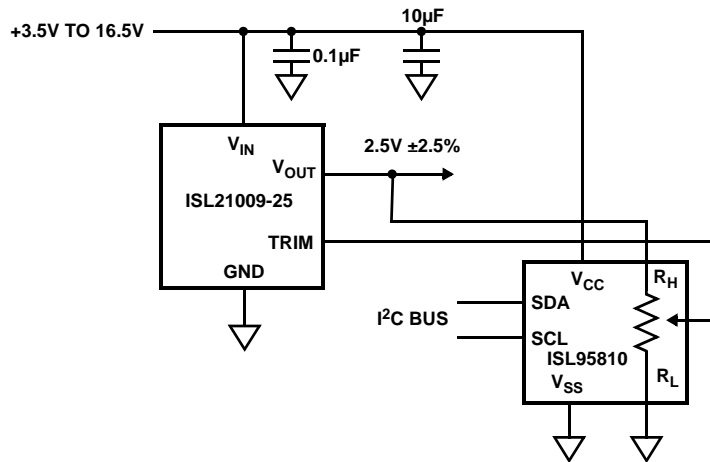
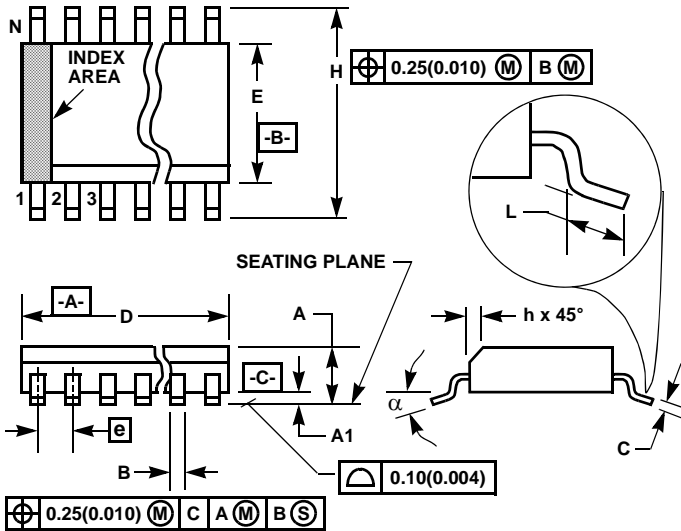

FIGURE 62. OUTPUT ADJUSTMENT USING THE TRIM PIN

Small Outline Plastic Packages (SOIC)



M8.15 (JEDEC MS-012-AA ISSUE C)
8 LEAD NARROW BODY SMALL OUTLINE PLASTIC PACKAGE

SYMBOL	INCHES		MILLIMETERS		NOTES
	MIN	MAX	MIN	MAX	
A	0.0532	0.0688	1.35	1.75	-
A1	0.0040	0.0098	0.10	0.25	-
B	0.013	0.020	0.33	0.51	9
C	0.0075	0.0098	0.19	0.25	-
D	0.1890	0.1968	4.80	5.00	3
E	0.1497	0.1574	3.80	4.00	4
e	0.050 BSC		1.27 BSC		-
H	0.2284	0.2440	5.80	6.20	-
h	0.0099	0.0196	0.25	0.50	5
L	0.016	0.050	0.40	1.27	6
N	8		8		7
a	0°	8°	0°	8°	-

NOTES:

1. Symbols are defined in the "MO Series Symbol List" in Section 2.2 of Publication Number 95.
2. Dimensioning and tolerancing per ANSI Y14.5M-1982.
3. Dimension "D" does not include mold flash, protrusions or gate burrs. Mold flash, protrusion and gate burrs shall not exceed 0.15mm (0.006 inch) per side.
4. Dimension "E" does not include interlead flash or protrusions. Interlead flash and protrusions shall not exceed 0.25mm (0.010 inch) per side.
5. The chamfer on the body is optional. If it is not present, a visual index feature must be located within the crosshatched area.
6. "L" is the length of terminal for soldering to a substrate.
7. "N" is the number of terminal positions.
8. Terminal numbers are shown for reference only.
9. The lead width "B", as measured 0.36mm (0.014 inch) or greater above the seating plane, shall not exceed a maximum value of 0.61mm (0.024 inch).
10. Controlling dimension: MILLIMETER. Converted inch dimensions are not necessarily exact.

Rev. 1 6/05

All Intersil U.S. products are manufactured, assembled and tested utilizing ISO9000 quality systems.
Intersil Corporation's quality certifications can be viewed at www.intersil.com/design/quality

Intersil products are sold by description only. Intersil Corporation reserves the right to make changes in circuit design, software and/or specifications at any time without notice. Accordingly, the reader is cautioned to verify that data sheets are current before placing orders. Information furnished by Intersil is believed to be accurate and reliable. However, no responsibility is assumed by Intersil or its subsidiaries for its use; nor for any infringements of patents or other rights of third parties which may result from its use. No license is granted by implication or otherwise under any patent or patent rights of Intersil or its subsidiaries.

For information regarding Intersil Corporation and its products, see www.intersil.com