



# TS824-1.2

## HIGH THERMAL STABILITY MICROPOWER SHUNT VOLTAGE REFERENCE

- LOW Tc: 50 ppm/°C MAXIMUM
- 1.225V OUTPUT VOLTAGE
- LOW OPERATING CURRENT: 45µA max @ 25°C
- HIGH PRECISION AT 25°C: ±1%
- STABLE WHEN USED WITH CAPACITIVE LOADS
- INDUSTRIAL TEMPERATURE RANGE: -40 to +85°C

### DESCRIPTION

The TS824 is a low power shunt voltage reference featuring a very low temperature coefficient of 50ppm/°C as a maximum value. Providing 1.225V output voltage, the TS824 operates over the industrial temperature range (-40 to +85°C). Ideal for battery-powered equipments where power conservation is critical, the TS824 is housed in a tiny SOT23-3 package allowing space saving.

The TS824 is typically stable with any capacitive loads within the entire temperature range. The product is thus easy to use and the design simplified.

### APPLICATION

- Instrumentation,
- Data acquisition systems,
- Portable, Battery powered equipments
- Power management

### ORDER CODE

Voltage	Precision	SOT23-3	SOT23 Marking
1.225V	1%	TS824ILT-1.2	L251
Single temperature range: -40 to +85°C			

LT = Tiny Package (SOT23-3) - only available in Tape & Reel (LT)

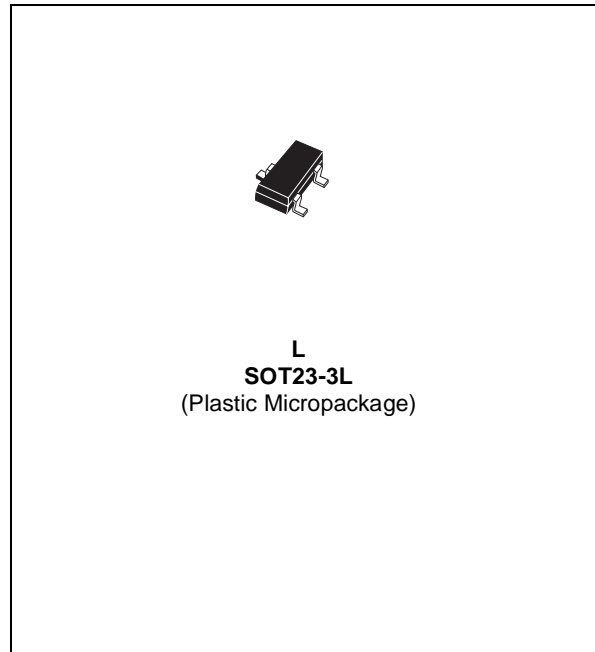

### PIN CONNECTIONS (top view)

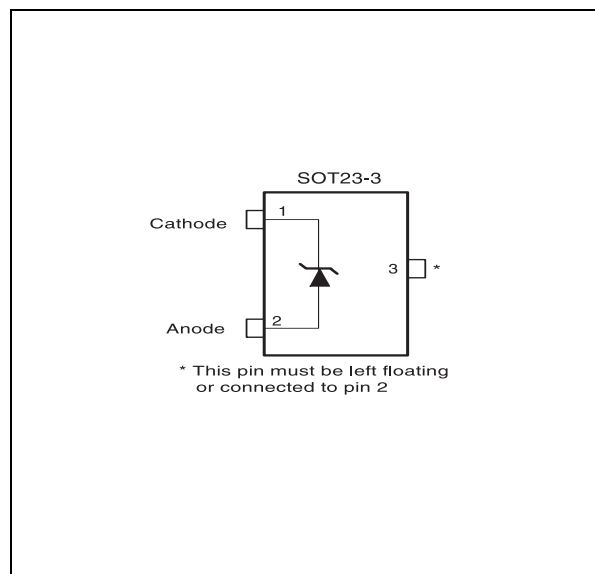

**ABSOLUTE MAXIMUM RATINGS**

Symbol	Parameter	Value	Unit
$I_K$	Reverse Breakdown Current	20	mA
$I_F$	Forward Current	10	mA
$P_D$	Power Dissipation (note 1) SOT23-3	360	mW
$T_{Std}$	Storage Temperature	-65 to +150	°C
$T_J$	Junction Temperature	+150	°C
$T_{Lead}$	Lead Temperature (soldering, 10 seconds)	+260	°C
ESD	Human Body Model (HBM) (note 2)	2	kV
	Machine Model (MM) (note 2)	200	V

**Note 1:** The maximum power dissipation must be derated at high temperature. It can be calculated using  $T_{JMAX}$  (maximum junction temperature),  $R_{THJA}$  (Thermal resistance junction to ambient) and  $T_A$  (Ambient temperature). The maximum power dissipation formula at any temperature is  $P_{DMAX} = (T_{JMAX} - T_A) / R_{THJA}$ .  $R_{THJA}$  is 340°C/W for the SOT23-3 package.

**Note 2:** The Human Body Model (HBM) is defined as a 100pF capacitor discharge through a 1.5kΩ resistor into each pin. The Machine Mode (MM) is defined as a 200pF capacitor discharge directly into each pins.

**OPERATING CONDITIONS**

Symbol	Parameter	Value	Unit
$I_{min}$	Minimum Operating Current	40	μA
$I_{max}$	Maximum Operating Current	12	mA
$T_{oper}$	Operating Free Air Temperature Range	-40 to +85	°C

**ELECTRICAL CHARACTERISTICS (note 3)**

$T_{amb} = 25^\circ\text{C}$  (unless otherwise specified)

Symbol	Parameter	Test Condition	Min.	Typ.	Max.	Unit
$V_K$	Reverse Breakdown Voltage	$I_K = 100\mu\text{A}$	1.213	1.225	1.237	V
	Reverse Breakdown Voltage Tolerance	$I_K = 100\mu\text{A}$ $-40^\circ\text{C} < T_{amb} < +85^\circ\text{C}$	-12 -16		+12 +16	mV
$I_{KMIN}$	Minimum Operating Current	$T_{amb} = 25^\circ\text{C}$		40	45	μA
		$-40^\circ\text{C} < T_{amb} < +85^\circ\text{C}$			50	
$\Delta V_K / \Delta T$	Average Temperature Coefficient (note 4)	$I_K = 100\mu\text{A}$			50	ppm/°C
$\Delta V_K / \Delta I_K$	Reverse Breakdown Voltage Change with Operating Current Range	$I_{KMIN} < I_K < 1\text{mA}$ $-40^\circ\text{C} < T_{amb} < +85^\circ\text{C}$		0.3	1 1.5	mV
		$1\text{mA} < I_K < 12\text{mA}$ $-40^\circ\text{C} < T_{amb} < +85^\circ\text{C}$		2.5	8 10	
$R_{KA}$	Static Impedance	$\Delta I_K = I_{KMIN}$ to 1mA $-40^\circ\text{C} < T_{amb} < +85^\circ\text{C}$		0.3	1 1.5	Ω
		$\Delta I_K = 1\text{mA}$ to 12mA $-40^\circ\text{C} < T_{amb} < +85^\circ\text{C}$		0.25	0.7 0.9	
$K_{VH}$	Long Term Stability	$I_K = 100\mu\text{A}$ , $t = 1000\text{hrs}$		120		ppm
$E_N$	Wide Band Noise	$I_K = 100\mu\text{A}$ $100\text{Hz} < f < 10\text{kHz}$		200		nV/√Hz

**Note 3:** Limits are 100% production tested at 25°C. Limits over temperature are guaranteed through correlation and by design.

**Note 4:** The total tolerance within the industrial range, where the maximum  $\Delta T$  versus 25°C is 65°C, is explained hereafter:  
 $\pm 1\% + (\pm 50 \text{ ppm}/^\circ\text{C} \times 65^\circ\text{C}) = \pm 1.325\%$

Reference voltage versus cathode current

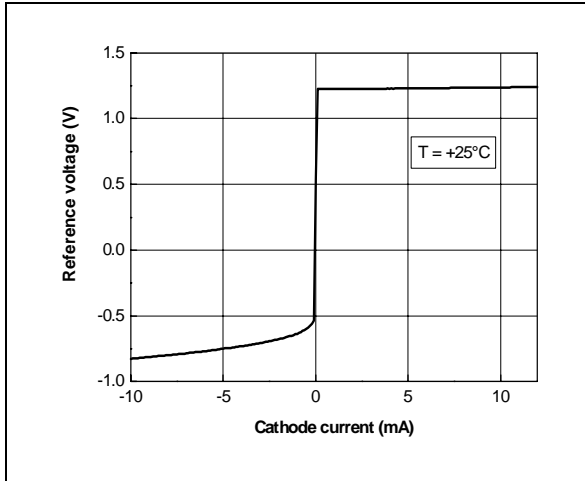

Reference voltage versus cathode current

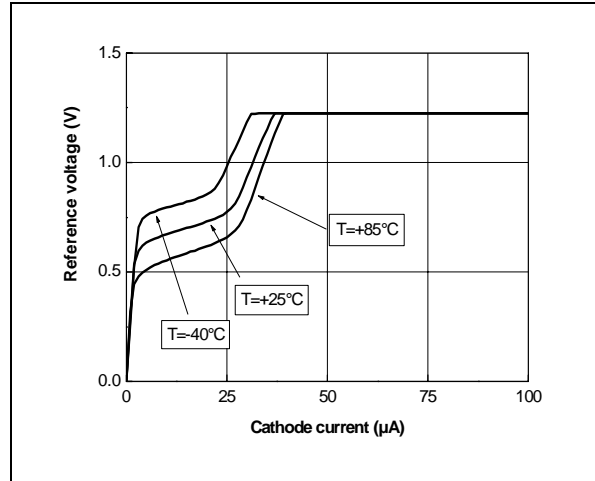

Test circuit

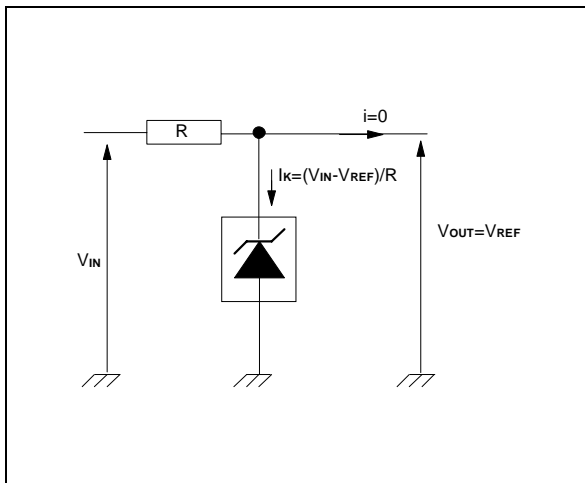

Reference voltage versus Temperature

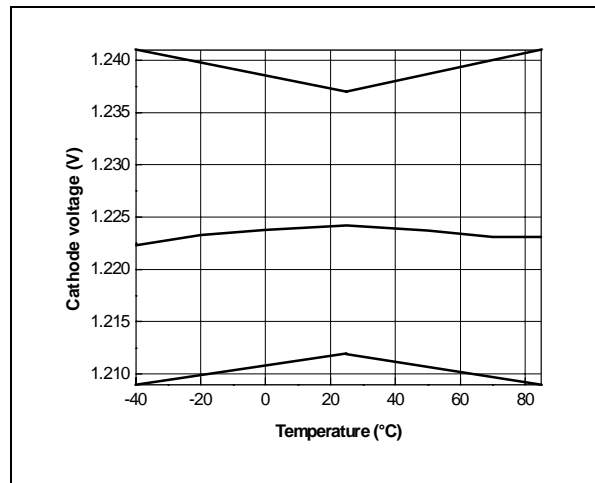

Static impedance for  $I_k < 1\text{mA}$

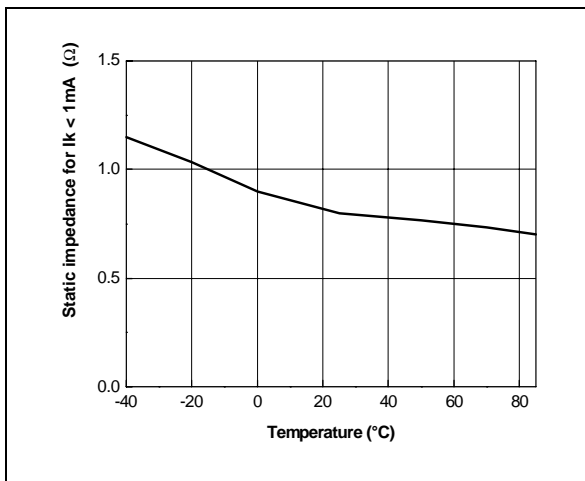

Static impedance for  $I_k > 1\text{mA}$

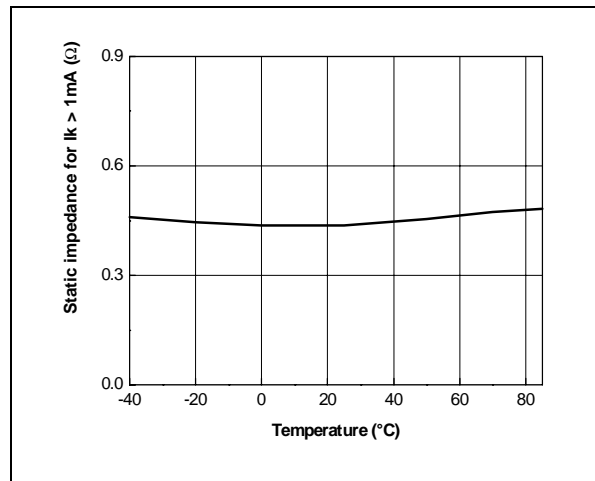

Start-Up characteristics with low  $I_k$  (100 $\mu$ A)

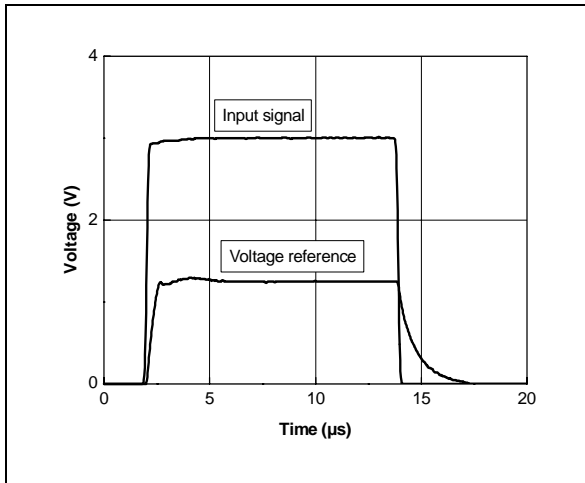

Start-Up schematic with low  $I_k$  (100 $\mu$ A)

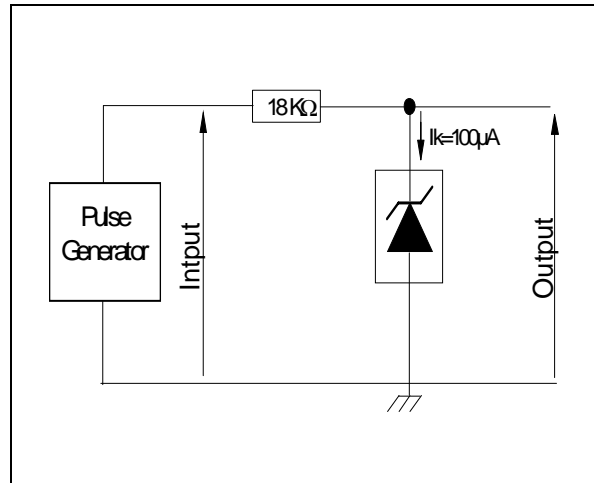

Noise versus frequency

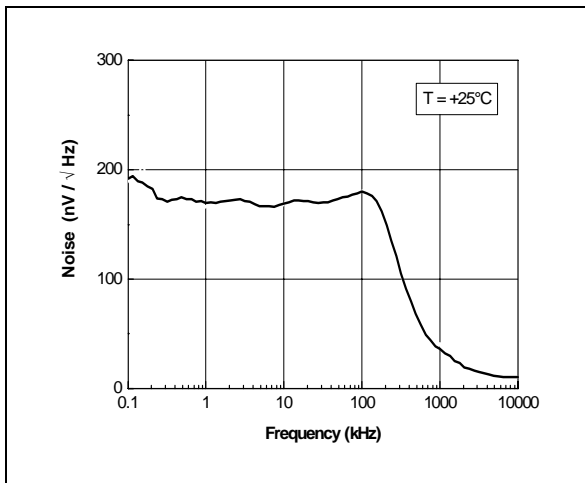

## PACKAGE MECHANICAL DATA

### 3 PINS - TINY PACKAGE (SOT23-3)

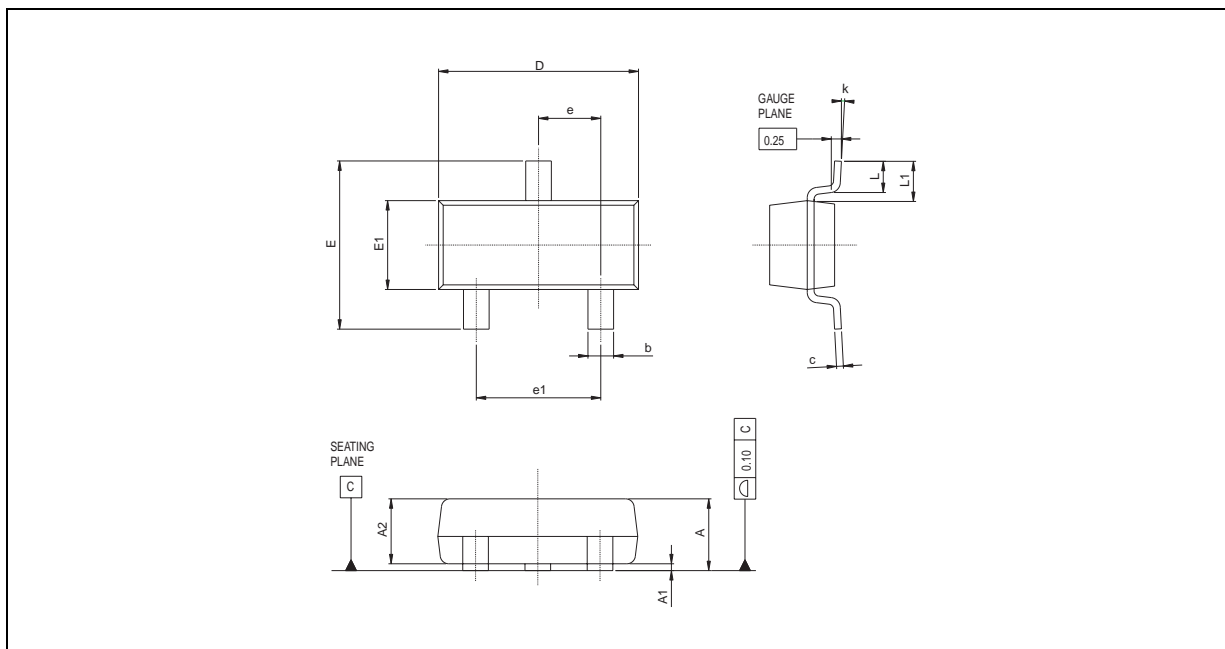

Dimensions	Millimeters			Inches		
	Min.	Typ.	Max.	Min.	Typ.	Max.
A	0.890		1.120	0.035		0.044
A1	0.010		0.100	0.0004		0.004
A2	0.880	0.950	1.020		0.037	0.040
b	0.300		0.500	0.012		0.020
c	0.080		0.200	0.003		0.008
D	2.800	2.900	3.040	0.110	0.114	0.120
E	2.100		2.640	0.083		0.104
E1	1.200	1.300	1.400	0.047	0.051	0.055
e		0.950			0.037	
e1		1.900			0.075	
L	0.400	0.500	0.600	0.016	0.020	0.024
L1		0.540			0.021	
k	0°		8°			

Information furnished is believed to be accurate and reliable. However, STMicroelectronics assumes no responsibility for the consequences of use of such information nor for any infringement of patents or other rights of third parties which may result from its use. No license is granted by implication or otherwise under any patent or patent rights of STMicroelectronics. Specifications mentioned in this publication are subject to change without notice. This publication supersedes and replaces all information previously supplied. STMicroelectronics products are not authorized for use as critical components in life support devices or systems without express written approval of STMicroelectronics.

© The ST logo is a registered trademark of STMicroelectronics

© 2002 STMicroelectronics - Printed in Italy - All Rights Reserved  
STMicroelectronics GROUP OF COMPANIES

Australia - Brazil - Canada - China - Finland - France - Germany - Hong Kong - India - Israel - Italy - Japan - Malaysia  
Malta - Morocco - Singapore - Spain - Sweden - Switzerland - United Kingdom - United States

© <http://www.st.com> - United Kingdom

