

ADR121/ADR125/ADR127

FEATURES

Initial accuracy

A grade: $\pm 0.24\%$

B grade: $\pm 0.12\%$

Maximum temperature coefficient

A grade: 25 ppm/ $^{\circ}\text{C}$

B grade: 9 ppm/ $^{\circ}\text{C}$

Low dropout: 300 mV for ADR121/ADR125

High output current: +5 mA/−2 mA

Low typical operating current: 85 μA

Input range: 2.7 V to 18 V for ADR127

Temperature range: -40°C to $+125^{\circ}\text{C}$

Tiny TSOT (UJ-6) package

APPLICATIONS

Battery-powered instrumentation

Portable medical equipment

Data acquisition systems

Automotive

GENERAL DESCRIPTION

The ADR121/ADR125/ADR127 are a family of micropower, high precision, series mode, band gap references with sink and source capability. The parts feature high accuracy and low power consumption in a tiny package. The ADR12x design includes a patented temperature-drift curvature correction technique that minimizes the nonlinearities in the output voltage vs. temperature characteristics.

PIN CONFIGURATION

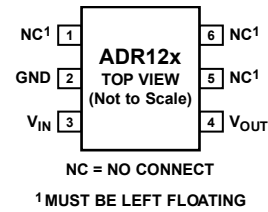

Figure 1.

The ADR12x is a low dropout voltage reference, requiring only 300 mV for the ADR121/ADR125 and 1.45 V for the ADR127 above the nominal output voltage on the input to provide a stable output voltage. This low dropout performance, coupled with the low 85 μA operating current, makes the ADR12x ideal for battery-powered applications.

Available in an extended industrial temperature range of -40°C to $+125^{\circ}\text{C}$, the ADR121/ADR125/ADR127 are housed in the tiny TSOT (UJ-6) package.

Rev. B

Information furnished by Analog Devices is believed to be accurate and reliable. However, no responsibility is assumed by Analog Devices for its use, nor for any infringements of patents or other rights of third parties that may result from its use. Specifications subject to change without notice. No license is granted by implication or otherwise under any patent or patent rights of Analog Devices. Trademarks and registered trademarks are the property of their respective owners.

TABLE OF CONTENTS

Features	1	Terminology	15
Applications.....	1	Theory of Operation	16
Pin Configuration.....	1	Power Dissipation Considerations.....	16
General Description	1	Input Capacitor.....	16
Revision History	2	Output Capacitor.....	16
Specifications.....	3	Applications Information	17
ADR121 Electrical Characteristics.....	3	Basic Voltage Reference Connection	17
ADR125 Electrical Characteristics.....	4	Stacking Reference ICs for Arbitrary Outputs	17
ADR127 Electrical Characteristics.....	5	Negative Precision Reference Without Precision Resistors..	17
Absolute Maximum Ratings.....	6	General-Purpose Current Source	17
Thermal Resistance	6	Outline Dimensions	18
ESD Caution.....	6	Ordering Guide	18
Typical Performance Characteristics	7		

REVISION HISTORY

1/08—Rev. A to Rev. B

Changes to Table 1.....	3
Changes to Table 2.....	4
Changes to Table 3.....	5
Changes to Figure 52.....	17
Changes to Ordering Guide	18

5/07—Rev. 0 to Rev. A

Changes to Table 1.....	3
Changes to Table 2.....	4
Changes to Table 3.....	5
Added Thermal Hysteresis Equation	7
Changes to Ordering Guide	18

6/06—Revision 0: Initial Version

SPECIFICATIONS

ADR121 ELECTRICAL CHARACTERISTICS

$T_A = 25^\circ\text{C}$, $V_{IN} = 2.8\text{ V}$ to 18 V , $I_{OUT} = 0\text{ mA}$, unless otherwise noted.

Table 1.

Parameter	Symbol	Conditions/Comments	Min	Typ	Max	Unit
OUTPUT VOLTAGE	V_{OUT}					
B Grade			2.497	2.5	2.503	V
A Grade			2.494	2.5	2.506	V
INITIAL ACCURACY ERROR	V_{OERR}					
B Grade			-0.12		+0.12	%
A Grade			-0.24		+0.24	%
TEMPERATURE COEFFICIENT	TCV_{OUT}	$-40^\circ\text{C} < T_A < +125^\circ\text{C}$				
B Grade				3	9	ppm/ $^\circ\text{C}$
A Grade				15	25	ppm/ $^\circ\text{C}$
DROPOUT ($V_{OUT} - V_{IN}$)	V_{DO}	$I_{OUT} = 0\text{ mA}$	300			mV
LOAD REGULATION		$-40^\circ\text{C} < T_A < +125^\circ\text{C}$; $V_{IN} = 5.0\text{ V}$, $0\text{ mA} < I_{OUT} < 5\text{ mA}$		80	300	ppm/mA
		$-40^\circ\text{C} < T_A < +125^\circ\text{C}$; $V_{IN} = 5.0\text{ V}$, $-2\text{ mA} < I_{OUT} < 0\text{ mA}$		50	300	ppm/mA
LINE REGULATION		2.8 V to 18 V , $I_{OUT} = 0\text{ mA}$	-50	+3	+50	ppm/V
PSRR		$f = 60\text{ Hz}$		-90		dB
QUIESCENT CURRENT	I_Q	$-40^\circ\text{C} < T_A < +125^\circ\text{C}$, no load				
		$V_{IN} = 18\text{ V}$		95	125	μA
		$V_{IN} = 2.8\text{ V}$		80	95	μA
SHORT-CIRCUIT CURRENT TO GROUND		$V_{IN} = 2.8\text{ V}$		18		mA
		$V_{IN} = 18\text{ V}$		40		mA
VOLTAGE NOISE		$f = 10\text{ kHz}$		500		nV/ $\sqrt{\text{Hz}}$
		$f = 0.1\text{ Hz}$ to 10 Hz		18		$\mu\text{V p-p}$
TURN-ON SETTLING TIME		To 0.1%, $C_L = 0.2\text{ }\mu\text{F}$		100		μs
LONG-TERM STABILITY		1000 hours @ 25°C		150		ppm/1000 hrs
OUTPUT VOLTAGE HYSTERESIS		See the Terminology section		300		ppm

ADR121/ADR125/ADR127

ADR125 ELECTRICAL CHARACTERISTICS

$T_A = 25^\circ\text{C}$, $V_{IN} = 5.3\text{ V}$ to 18 V , $I_{OUT} = 0\text{ mA}$, unless otherwise noted.

Table 2.

Parameter	Symbol	Conditions/Comments	Min	Typ	Max	Unit
OUTPUT VOLTAGE	V_{OUT}		4.994	5.0	5.006	V
B Grade						
A Grade			4.988	5.0	5.012	V
INITIAL ACCURACY ERROR	V_{OERR}		-0.12		+0.12	%
B Grade						
A Grade			-0.24		+0.24	%
TEMPERATURE COEFFICIENT	TCV_{OUT}	$-40^\circ\text{C} < T_A < +125^\circ\text{C}$		3	9	ppm/ $^\circ\text{C}$
B Grade						
A Grade				15	25	ppm/ $^\circ\text{C}$
DROPOUT ($V_{OUT} - V_{IN}$)	V_{DO}	$I_{OUT} = 5\text{ mA}$	300			mV
LOAD REGULATION		$-40^\circ\text{C} < T_A < +125^\circ\text{C}$; $V_{IN} = 6.0\text{ V}$, $0\text{ mA} < I_{OUT} < 5\text{ mA}$		35	200	ppm/mA
		$-40^\circ\text{C} < T_A < +125^\circ\text{C}$; $V_{IN} = 6.0\text{ V}$, $-2\text{ mA} < I_{OUT} < 0\text{ mA}$		35	200	ppm/mA
LINE REGULATION		5.3 V to 18 V , $I_{OUT} = 0\text{ mA}$			30	ppm/V
PSRR		$f = 60\text{ Hz}$		-90		dB
QUIESCENT CURRENT	I_Q	$-40^\circ\text{C} < T_A < +125^\circ\text{C}$, no load $V_{IN} = 18\text{ V}$ $V_{IN} = 5.3\text{ V}$		95	125	μA
SHORT-CIRCUIT CURRENT TO GROUND		$V_{IN} = 5.3\text{ V}$ $V_{IN} = 18\text{ V}$		25		mA
VOLTAGE NOISE		$f = 10\text{ kHz}$ $f = 0.1\text{ Hz}$ to 10 Hz		900		nV/ $\sqrt{\text{Hz}}$
TURN-ON SETTLING TIME		To 0.1%, $C_L = 0.2\text{ }\mu\text{F}$		100		μs
LONG-TERM STABILITY		1000 hours @ 25°C		150		ppm/1000 hrs
OUTPUT VOLTAGE HYSTERESIS		See the Terminology section		300		ppm

ADR127 ELECTRICAL CHARACTERISTICS

$T_A = 25^\circ\text{C}$, $V_{IN} = 2.7\text{ V}$ to 18 V , $I_{OUT} = 0\text{ mA}$, unless otherwise noted.

Table 3.

Parameter	Symbol	Conditions/Comments	Min	Typ	Max	Unit
OUTPUT VOLTAGE	V_{OUT}					
B Grade			1.2485	1.25	1.2515	V
A Grade			1.2470	1.25	1.2530	V
INITIAL ACCURACY ERROR	V_{OERR}					
B Grade			-0.12		+0.12	%
A Grade			-0.24		+0.24	%
TEMPERATURE COEFFICIENT	TCV_{OUT}	$-40^\circ\text{C} < T_A < +125^\circ\text{C}$				
B Grade				3	9	ppm/ $^\circ\text{C}$
A Grade				15	25	ppm/ $^\circ\text{C}$
DROPOUT ($V_{OUT} - V_{IN}$)	V_{DO}	$I_{OUT} = 0\text{ mA}$	1.45			V
LOAD REGULATION		$-40^\circ\text{C} < T_A < +125^\circ\text{C}$; $V_{IN} = 3.0\text{ V}$, $0\text{ mA} < I_{OUT} < 5\text{ mA}$		85	400	ppm/mA
		$-40^\circ\text{C} < T_A < +125^\circ\text{C}$; $V_{IN} = 3.0\text{ V}$, $-2\text{ mA} < I_{OUT} < 0\text{ mA}$		65	400	ppm/mA
LINE REGULATION		2.7 V to 18 V , $I_{OUT} = 0\text{ mA}$		30	90	ppm/V
PSRR		$f = 60\text{ Hz}$		-90		dB
QUIESCENT CURRENT	I_Q	$-40^\circ\text{C} < T_A < +125^\circ\text{C}$, no load				
		$V_{IN} = 18\text{ V}$		95	125	μA
		$V_{IN} = 2.7\text{ V}$		80	95	μA
SHORT-CIRCUIT CURRENT TO GROUND		$V_{IN} = 2.7\text{ V}$		15		mA
		$V_{IN} = 18\text{ V}$		30		mA
VOLTAGE NOISE		$f = 10\text{ kHz}$		300		nV/ $\sqrt{\text{Hz}}$
		$f = 0.1\text{ Hz}$ to 10 Hz		9		$\mu\text{V p-p}$
TURN-ON SETTLING TIME		To 0.1%, $C_L = 0.2\text{ }\mu\text{F}$		80		μs
LONG-TERM STABILITY		1000 hours @ 25°C		150		ppm/1000 hrs
OUTPUT VOLTAGE HYSTERESIS		See the Terminology section		300		ppm

ABSOLUTE MAXIMUM RATINGS

Table 4.

Parameter	Rating
V _{IN} to GND	20 V
Internal Power Dissipation TSOT (UJ-6)	40 mW
Storage Temperature Range	−65°C to +150°C
Operating Temperature Range	−40°C to +125°C
Lead Temperature, Soldering	
Vapor Phase (60 sec)	215°C
Infrared (15 sec)	220°C

Stresses above those listed under Absolute Maximum Ratings may cause permanent damage to the device. This is a stress rating only; functional operation of the device at these or any other conditions above those indicated in the operational section of this specification is not implied. Exposure to absolute maximum rating conditions for extended periods may affect device reliability.

THERMAL RESISTANCE

θ_{JA} is specified for the worst-case conditions, that is, a device soldered in a circuit board for surface-mount packages.

Table 5.

Package Type	θ_{JA}	θ_{JC}	Unit
6-Lead TSOT (UJ-6)	230	146	°C/W

ESD CAUTION



ESD (electrostatic discharge) sensitive device. Charged devices and circuit boards can discharge without detection. Although this product features patented or proprietary protection circuitry, damage may occur on devices subjected to high energy ESD. Therefore, proper ESD precautions should be taken to avoid performance degradation or loss of functionality.

TYPICAL PERFORMANCE CHARACTERISTICS

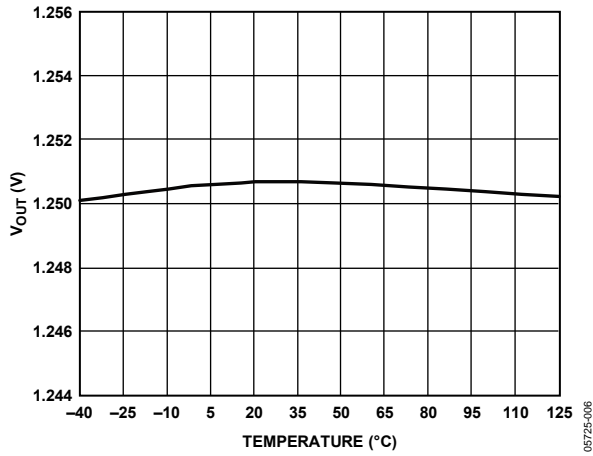

Figure 2. ADR127 V_{OUT} vs. Temperature

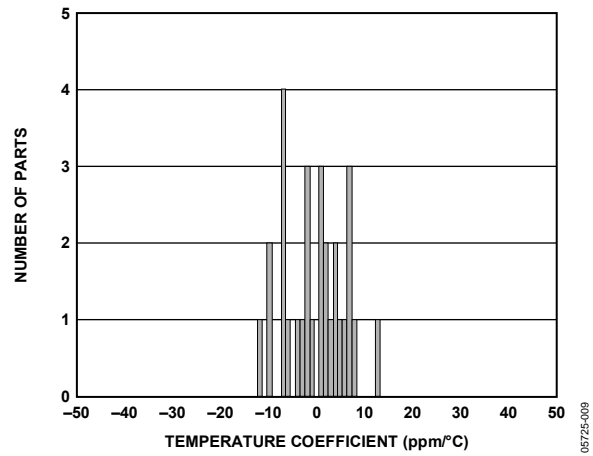

Figure 5. ADR127 Temperature Coefficient

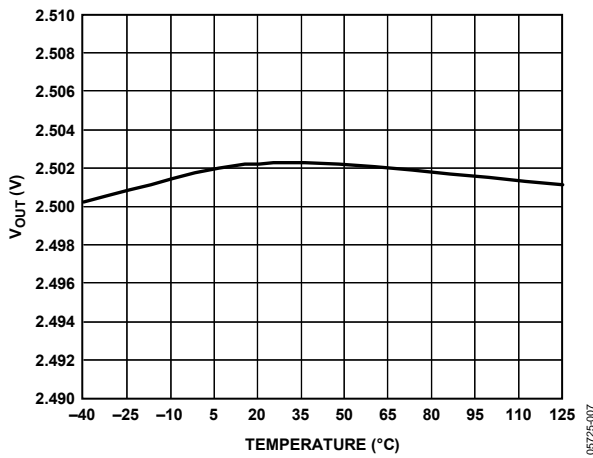

Figure 3. ADR121 V_{OUT} vs. Temperature

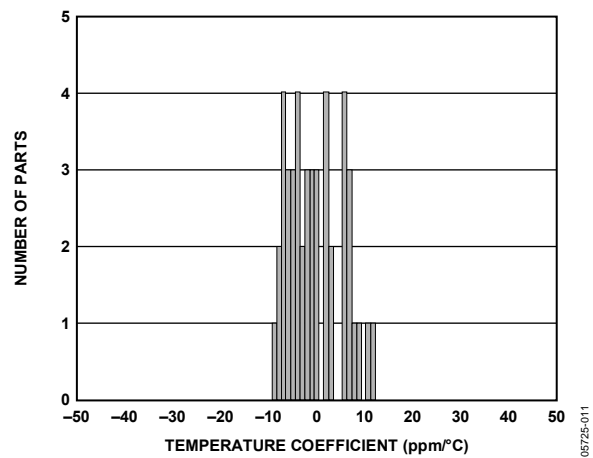

Figure 6. ADR121 Temperature Coefficient

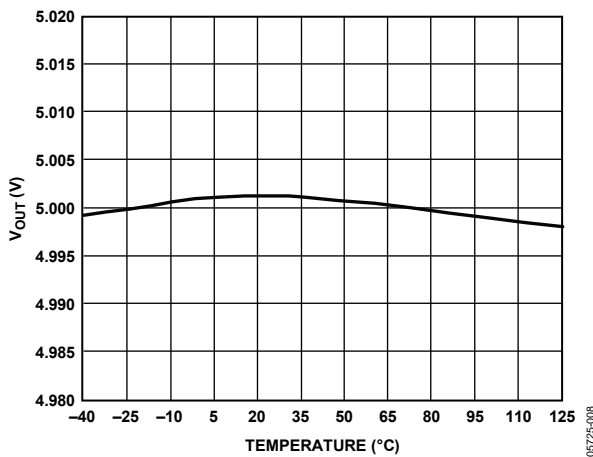

Figure 4. ADR125 V_{OUT} vs. Temperature

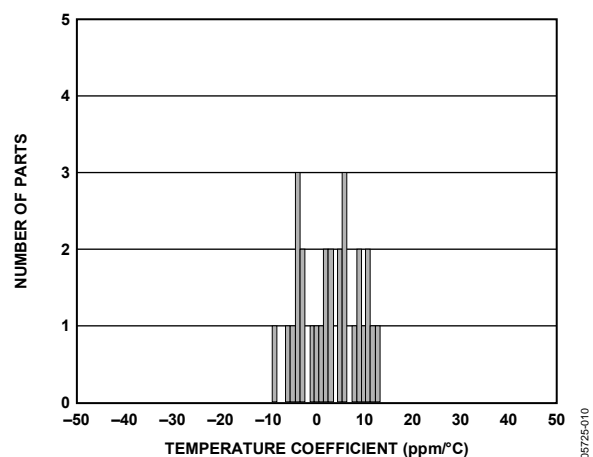

Figure 7. ADR125 Temperature Coefficient

ADR121/ADR125/ADR127

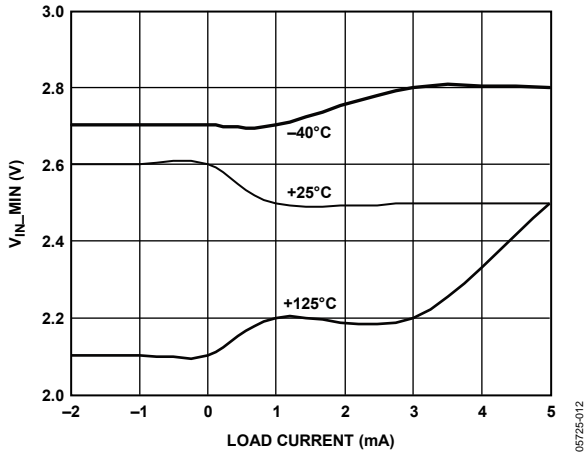

Figure 8. ADR127 Minimum Input Voltage vs. Load Current

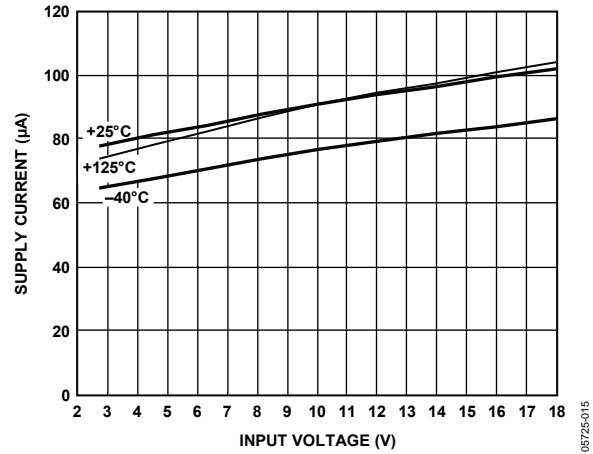

Figure 11. ADR127 Supply Current vs. Input Voltage

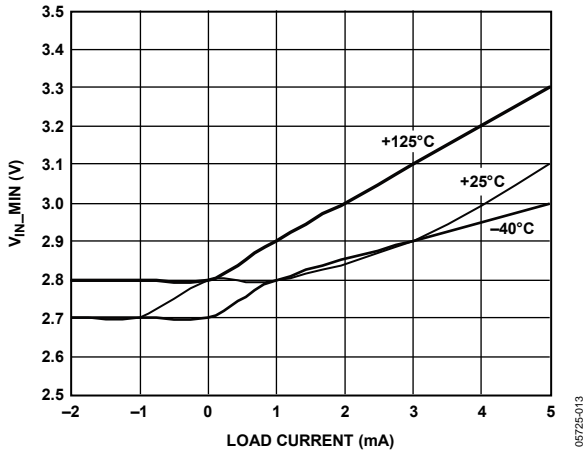

Figure 9. ADR121 Minimum Input Voltage vs. Load Current

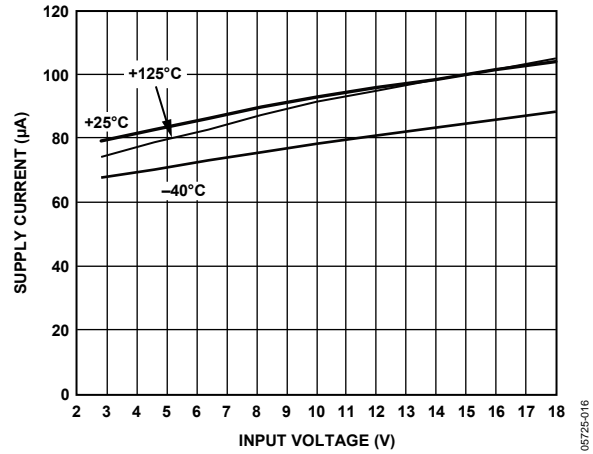

Figure 12. ADR121 Supply Current vs. Input Voltage

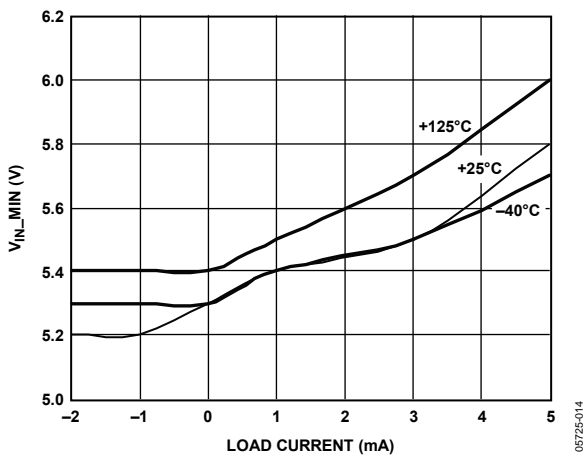

Figure 10. ADR125 Minimum Input Voltage vs. Load Current

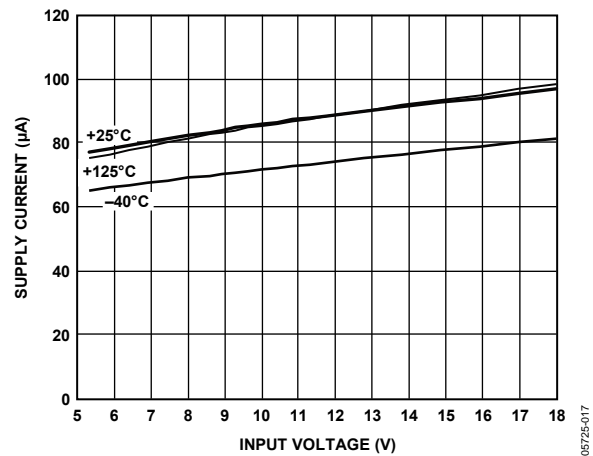

Figure 13. ADR125 Supply Current vs. Input Voltage

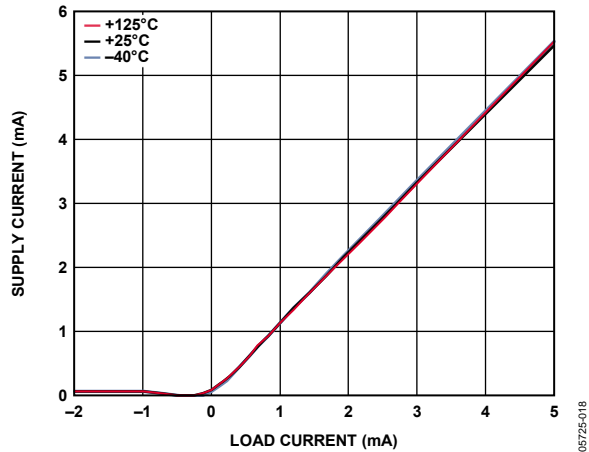

Figure 14. ADR127 Supply Current vs. Load Current

05725-018

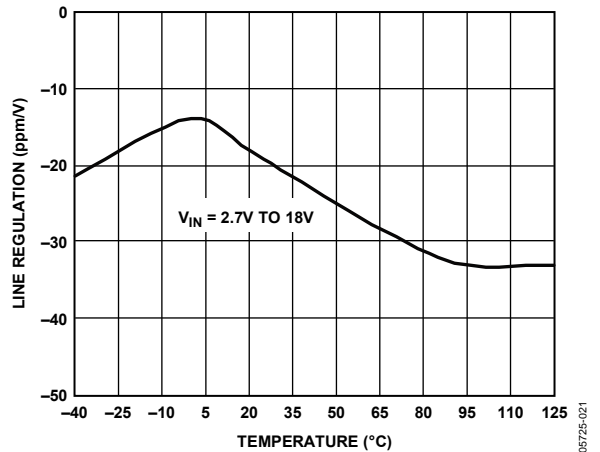

Figure 17. ADR127 Line Regulation vs. Temperature

05725-021

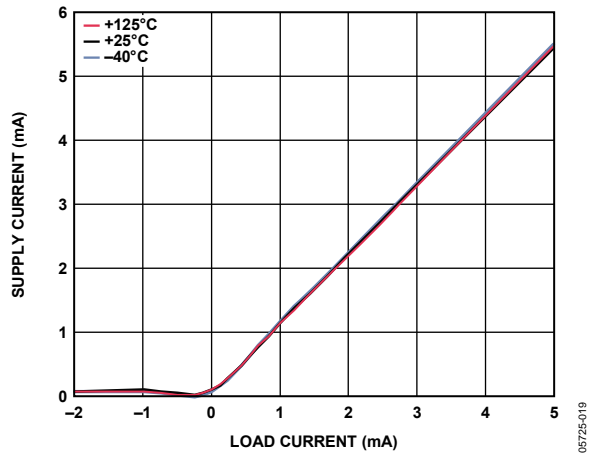

Figure 15. ADR121 Supply Current vs. Load Current

05725-019

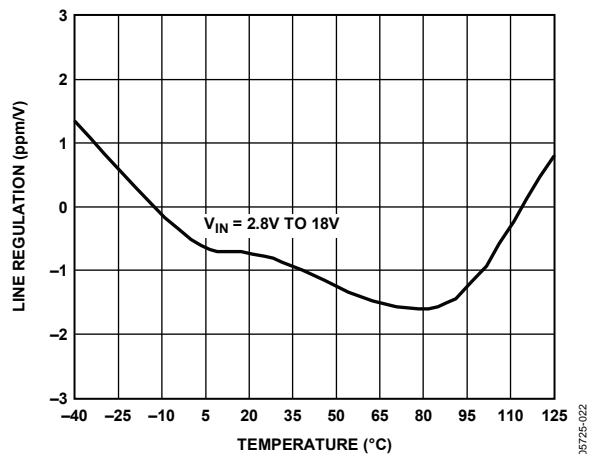

Figure 18. ADR121 Line Regulation vs. Temperature

05725-020

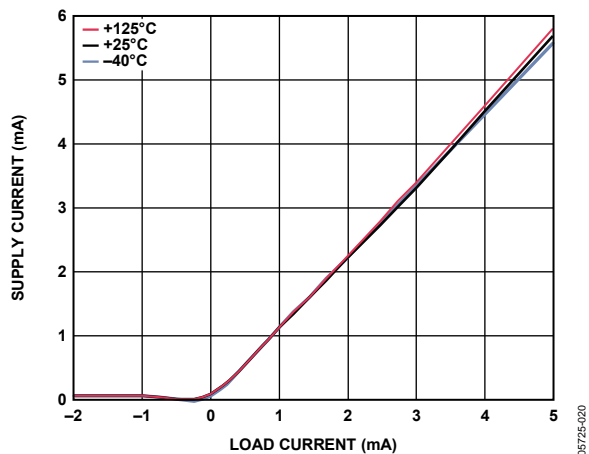

Figure 16. ADR125 Supply Current vs. Load Current

05725-020

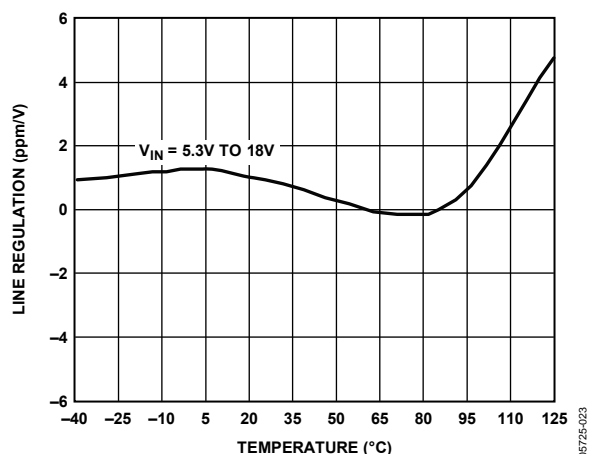

Figure 19. ADR125 Line Regulation vs. Temperature

05725-023

ADR121/ADR125/ADR127

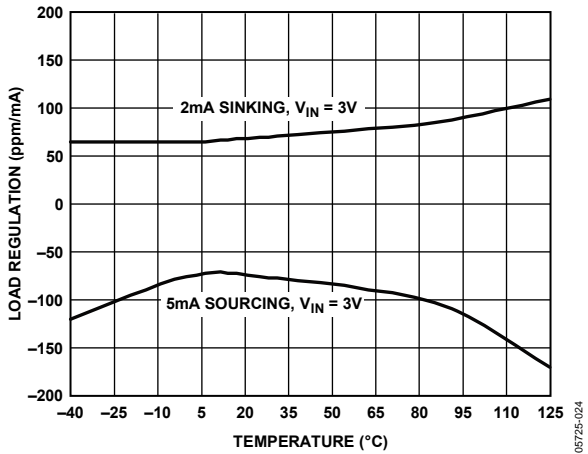

Figure 20. ADR127 Load Regulation vs. Temperature

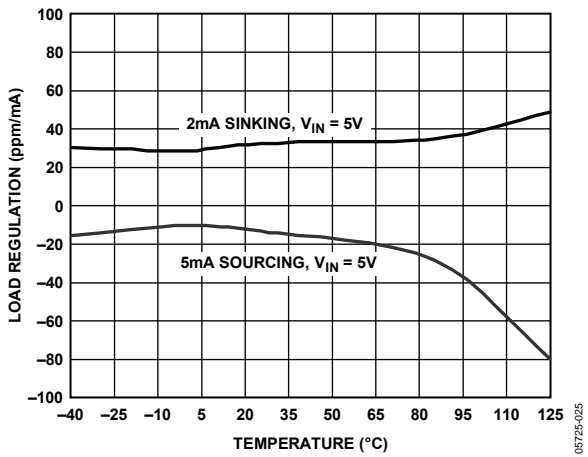

Figure 21. ADR121 Load Regulation vs. Temperature

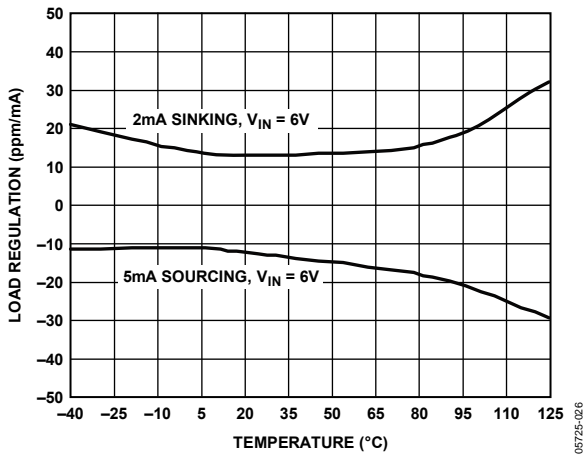

Figure 22. ADR125 Load Regulation vs. Temperature

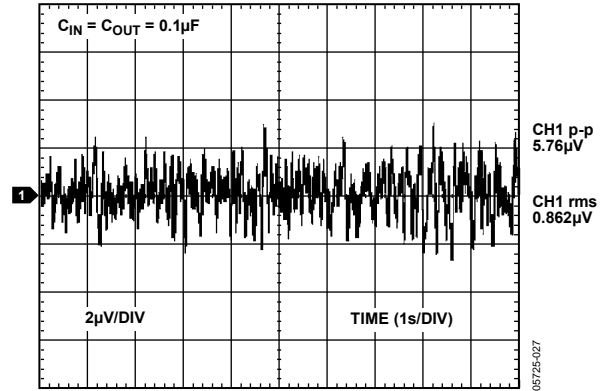

Figure 23. ADR127 0.1 Hz to 10 Hz Noise

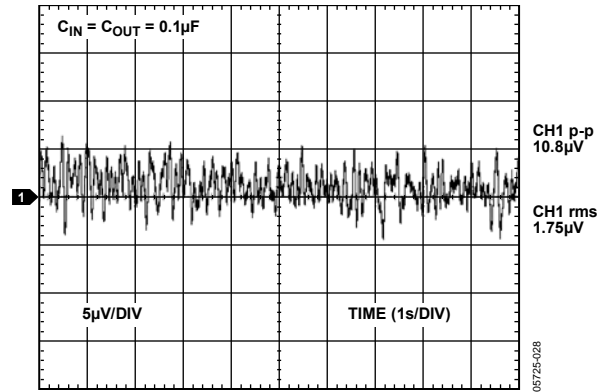

Figure 24. ADR121 0.1 Hz to 10 Hz Noise

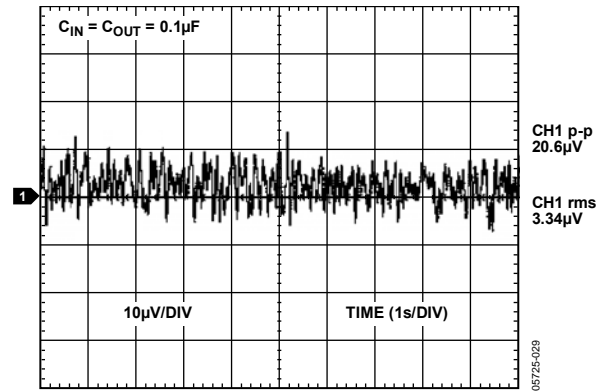

Figure 25. ADR125 0.1 Hz to 10 Hz Noise

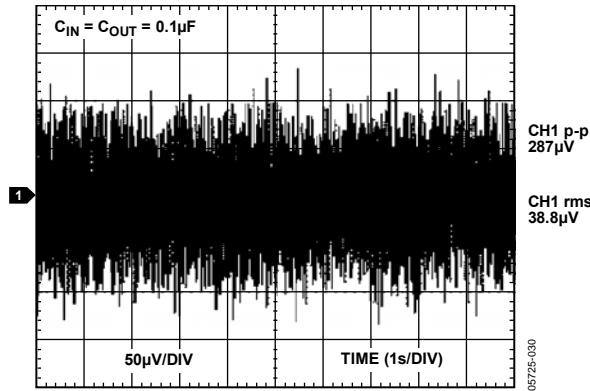

Figure 26. ADR127 10 Hz to 10 kHz Noise

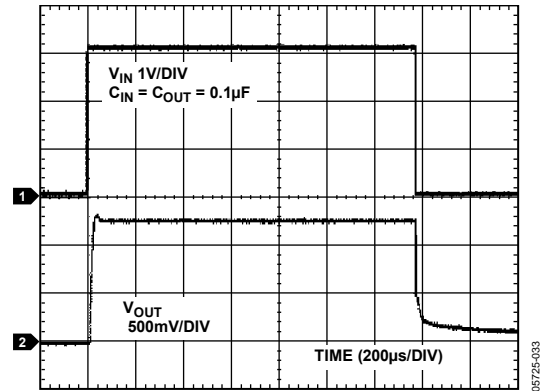

Figure 29. ADR127 Turn-On Response

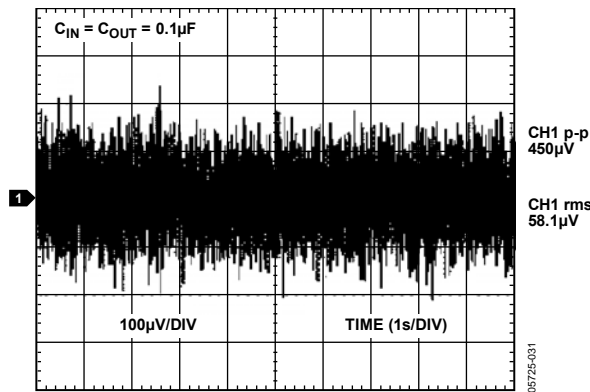

Figure 27. ADR121 10 Hz to 10 kHz Noise

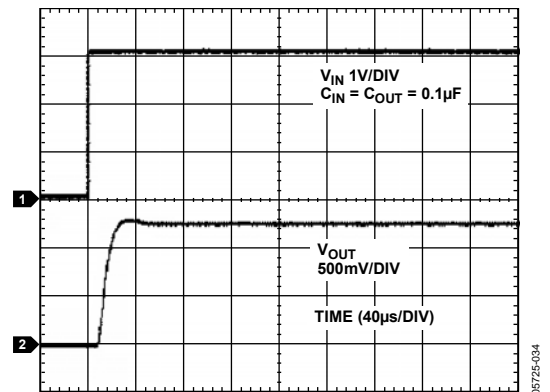

Figure 30. ADR127 Turn-On Response

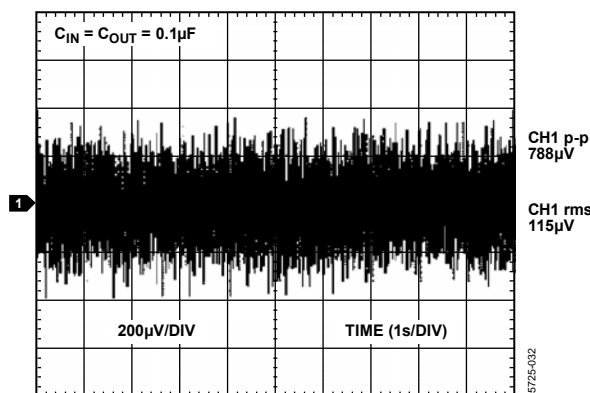

Figure 28. ADR125 10 Hz to 10 kHz Noise

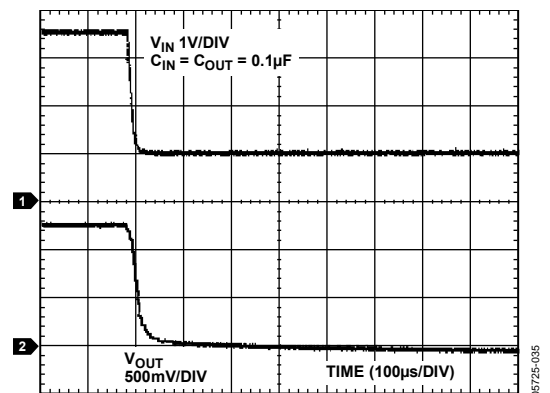

Figure 31. ADR127 Turn-Off Response

ADR121/ADR125/ADR127

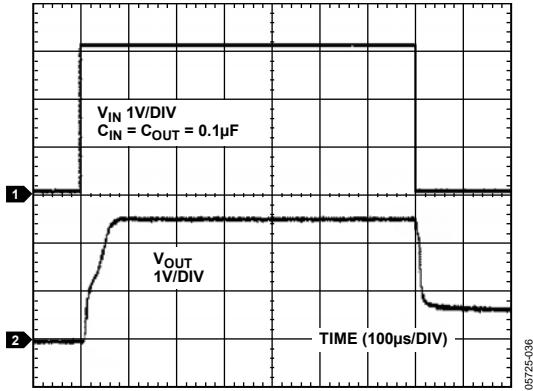

Figure 32. ADR121 Turn-On Response

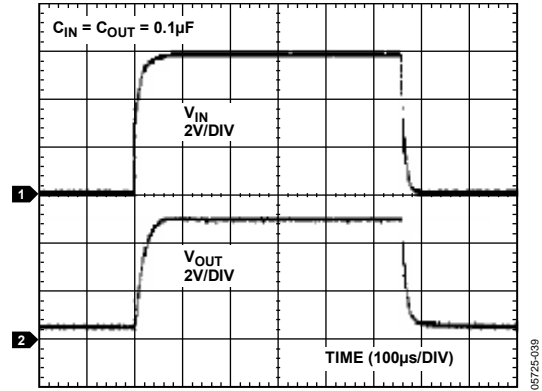

Figure 35. ADR125 Turn-On Response

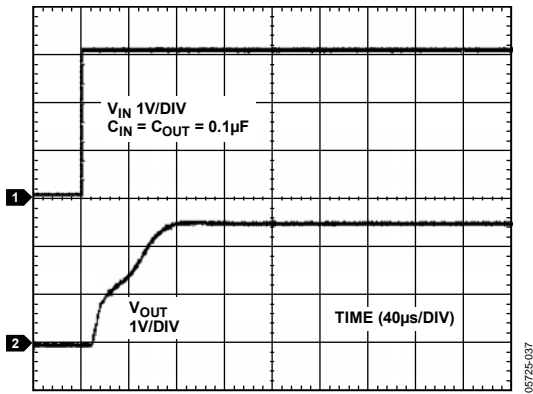

Figure 33. ADR121 Turn-On Response

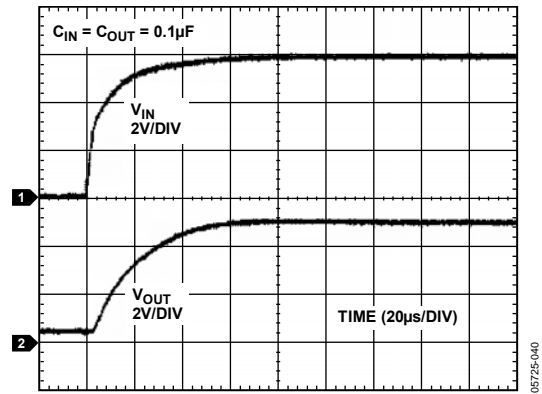

Figure 36. ADR125 Turn-On Response

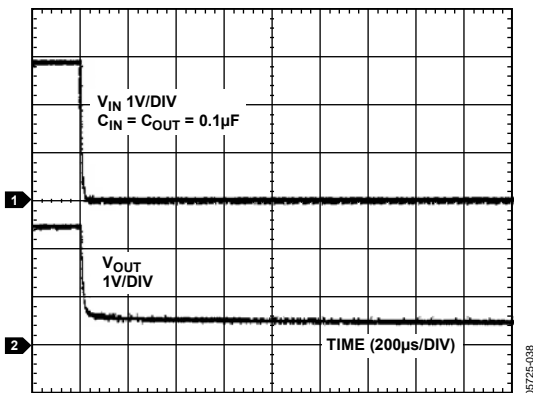

Figure 34. ADR121 Turn-Off Response

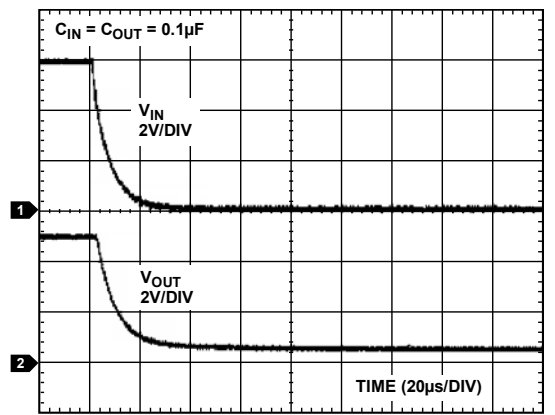

Figure 37. ADR125 Turn-Off Response

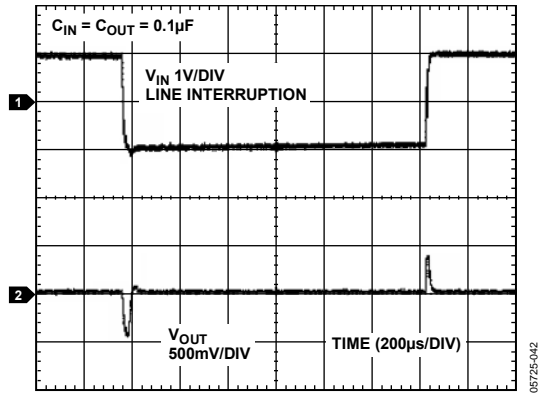

Figure 38. ADR127 Line Transient Response

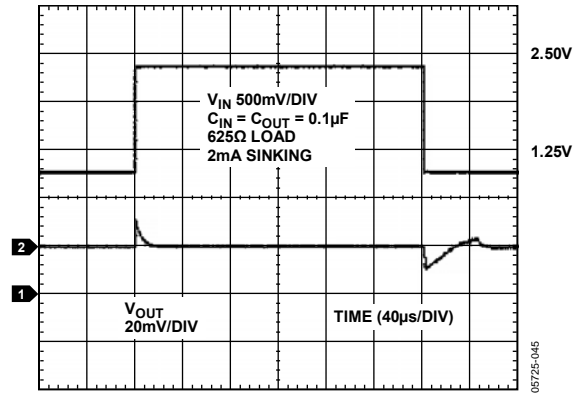

Figure 41. ADR127 Load Transient Response (Sinking)

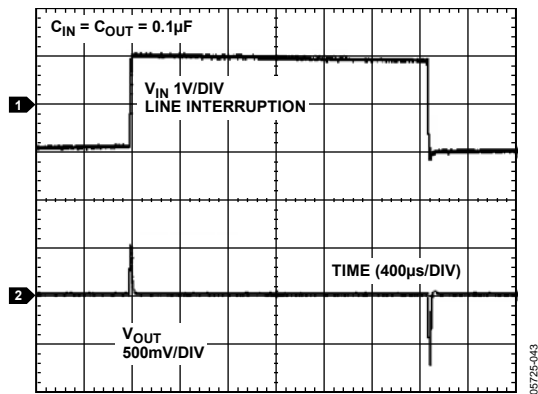

Figure 39. ADR121 Line Transient Response

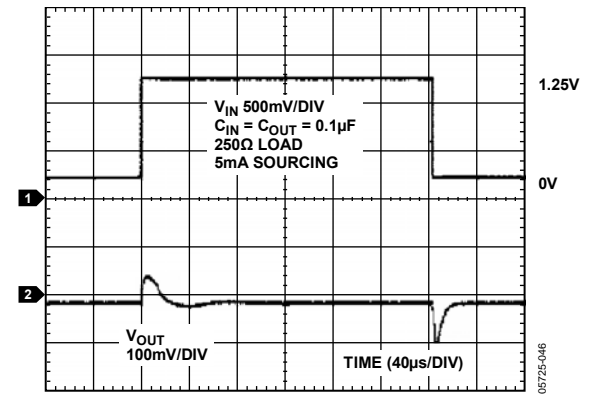

Figure 42. ADR127 Load Transient Response (Sourcing)

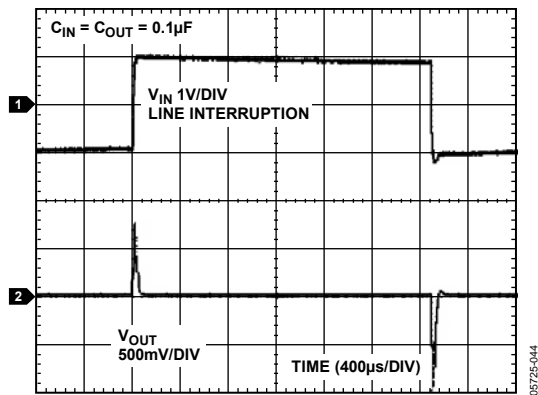

Figure 40. ADR125 Line Transient Response

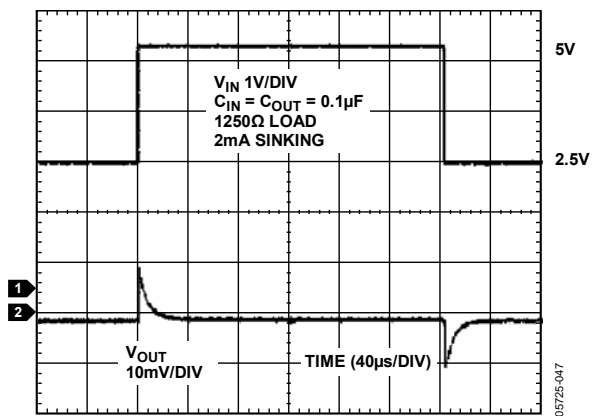

Figure 43. ADR121 Load Transient Response (Sinking)

ADR121/ADR125/ADR127

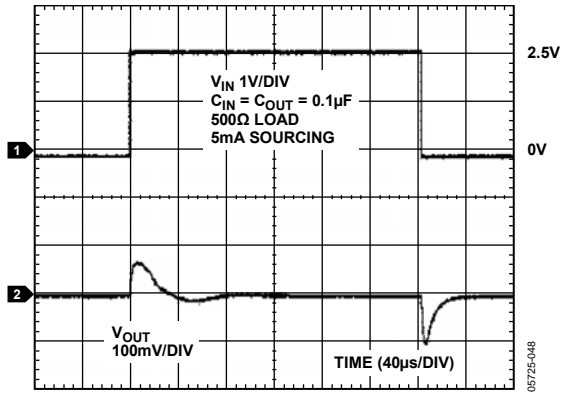

Figure 44. ADR121 Load Transient Response (Sourcing)

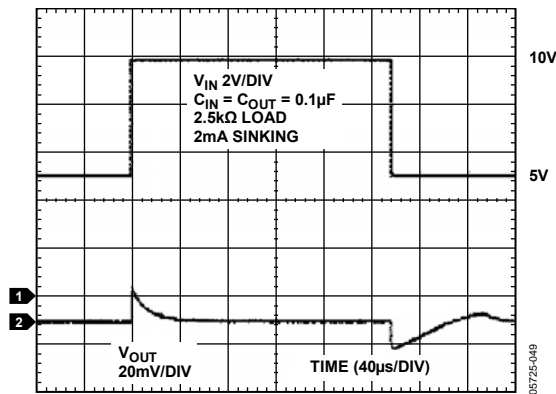

Figure 45. ADR125 Load Transient Response (Sinking)

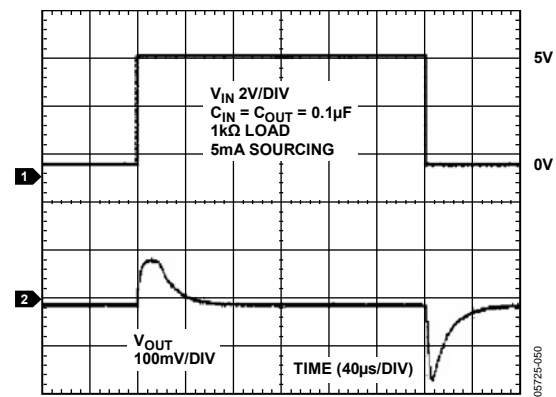

Figure 46. ADR125 Load Transient Response (Sourcing)

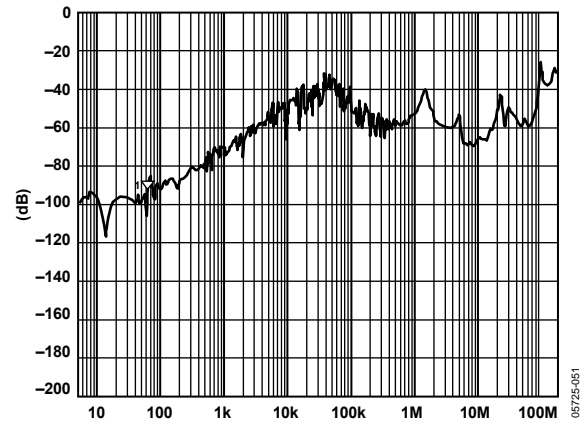

Figure 47. ADR121/ADR125/ADR127 PSRR

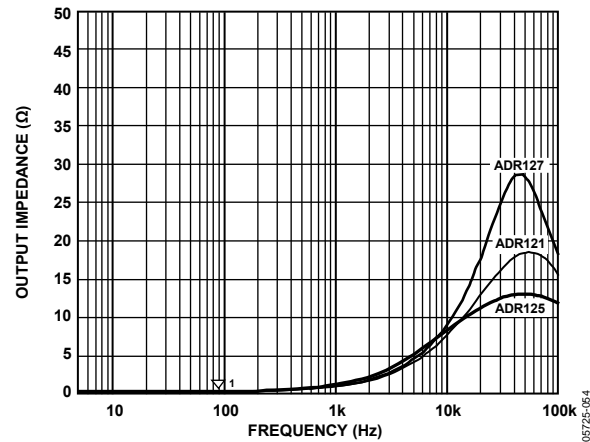

Figure 48. ADR121/ADR125/ADR127 Output Impedance vs. Frequency

TERMINOLOGY

Temperature Coefficient

The change in output voltage with respect to operating temperature change normalized by the output voltage at 25°C. This parameter is expressed in ppm/°C and can be determined as follows:

$$TCV_{OUT} [\text{ppm}/^{\circ}\text{C}] = \frac{V_{OUT}(T_2) - V_{OUT}(T_1)}{V_{OUT}(25^{\circ}\text{C}) \times (T_2 - T_1)} \times 10^6 \quad (1)$$

where:

$V_{OUT}(25^{\circ}\text{C}) = V_{OUT}$ at 25°C.

$V_{OUT}(T_1) = V_{OUT}$ at Temperature 1.

$V_{OUT}(T_2) = V_{OUT}$ at Temperature 2.

Line Regulation

The change in the output voltage due to a specified change in input voltage. This parameter accounts for the effects of self-heating. Line regulation is expressed in percent per volt, parts-per-million per volt, or microvolts per voltage change in input voltage.

Load Regulation

The change in output voltage due to a specified change in load current. This parameter accounts for the effects of self-heating. Load regulation is expressed in microvolts per milliampere, parts-per-million per milliampere, or ohms of dc output resistance.

Long-Term Stability

Typical shift of output voltage at 25°C on a sample of parts subjected to a test of 1000 hours at 25°C.

$$\Delta V_{OUT} = V_{OUT}(t_0) - V_{OUT}(t_1) \quad (2)$$

$$\Delta V_{OUT} [\text{ppm}] = \frac{V_{OUT}(t_0) - V_{OUT}(t_1)}{V_{OUT}(t_0)} \times 10^6$$

where:

$V_{OUT}(t_0) = V_{OUT}$ at 25°C at Time 0.

$V_{OUT}(t_1) = V_{OUT}$ at 25°C after 1000 hours operating at 25°C.

Thermal Hysteresis

The change in output voltage after the device is cycled through temperatures from +25°C to -40°C to +125°C and back to +25°C. This is a typical value from a sample of parts put through such a cycle.

$$V_{OUT_HYS} = V_{OUT}(25^{\circ}\text{C}) - V_{OUT_TC} \quad (3)$$

$$V_{OUT_HYS} [\text{ppm}] = \frac{V_{OUT}(25^{\circ}\text{C}) - V_{OUT_TC}}{V_{OUT}(25^{\circ}\text{C})} \times 10^6$$

where:

$V_{OUT}(25^{\circ}\text{C}) = V_{OUT}$ at 25°C.

$V_{OUT_TC} = V_{OUT}$ at 25°C after temperature cycle at +25°C to -40°C to +125°C and back to +25°C.

THEORY OF OPERATION

The ADR12x band gap references are the high performance solution for low supply voltage and low power applications. The uniqueness of these products lies in their architecture.

POWER DISSIPATION CONSIDERATIONS

The ADR12x family is capable of delivering load currents up to 5 mA with an input range from 3.0 V to 18 V. When this device is used in applications with large input voltages, care must be taken to avoid exceeding the specified maximum power dissipation or junction temperature because this could result in premature device failure.

Use the following formula to calculate a device's maximum junction temperature or dissipation:

$$P_D = \frac{T_J - T_A}{\theta_{JA}} \quad (4)$$

where:

T_J is the junction temperature.

T_A is the ambient temperature.

P_D is the device power dissipation.

θ_{JA} is the device package thermal resistance.

INPUT CAPACITOR

Input capacitors are not required on the ADR12x. There is no limit for the value of the capacitor used on the input, but a 1 μF to 10 μF capacitor on the input may improve transient response in applications where there is a sudden supply change. An additional 0.1 μF capacitor in parallel also helps reduce noise from the supply.

OUTPUT CAPACITOR

The ADR12x requires a small 0.1 μF capacitor for stability. Additional 0.1 μF to 10 μF capacitance in parallel can improve load transient response. This acts as a source of stored energy for a sudden increase in load current. The only parameter affected with the additional capacitance is turn-on time.

APPLICATIONS INFORMATION

BASIC VOLTAGE REFERENCE CONNECTION

The circuit in Figure 49 illustrates the basic configuration for the ADR12x family voltage reference.

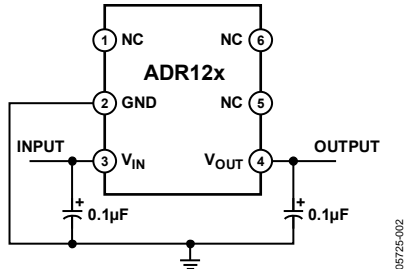

Figure 49. Basic Configuration for the ADR12x Family

STACKING REFERENCE ICs FOR ARBITRARY OUTPUTS

Some applications may require two reference voltage sources that are a combined sum of the standard outputs. Figure 50 shows how this stacked output reference can be implemented.

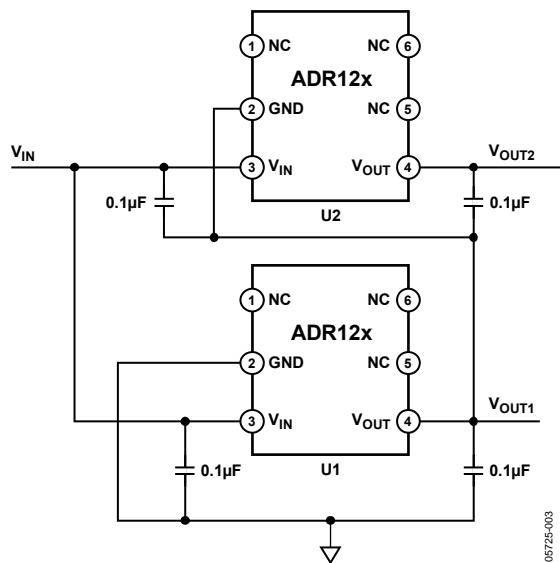

Figure 50. Stacking References with the ADR12x

Two reference ICs are used and fed from an unregulated input, V_{IN} . The outputs of the individual ICs are connected in series, which provides two output voltages, V_{OUT1} and V_{OUT2} . V_{OUT1} is the terminal voltage of U1, whereas V_{OUT2} is the sum of this voltage and the terminal of U2. U1 and U2 are chosen for the two voltages that supply the required outputs (see Table 6). For example, if U1 and U2 are ADR127s and $V_{IN} \geq 3.95$ V, V_{OUT1} is 1.25 V and V_{OUT2} is 2.5 V.

Table 6. Required Outputs

U1/U2	V_{OUT2}	V_{OUT1}
ADR127/ADR121	1.25 V	3.75 V
ADR127/ADR125	1.25 V	6.25 V
ADR121/ADR125	2.5 V	7.5 V

NEGATIVE PRECISION REFERENCE WITHOUT PRECISION RESISTORS

A negative reference is easily generated by adding an op amp, for example, the AD8603, and is configured as shown in Figure 51. V_{OUT} is at virtual ground and, therefore, the negative reference can be taken directly from the output of the op amp. The op amp must be dual-supply, low offset, and rail-to-rail if the negative supply voltage is close to the reference output.

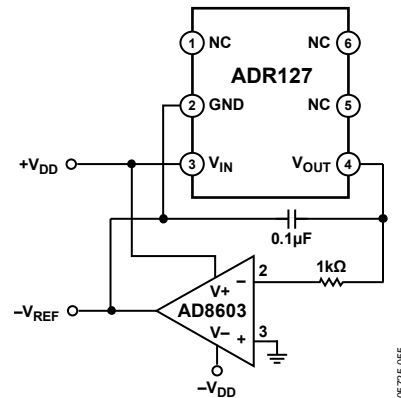

Figure 51. Negative Reference

GENERAL-PURPOSE CURRENT SOURCE

In low power applications, the need can arise for a precision current source that can operate on low supply voltages. The ADR12x can be configured as a precision current source (see Figure 52). The circuit configuration shown is a floating current source with a grounded load. The reference's output voltage is bootstrapped across R_{SET} , which sets the output current into the load. With this configuration, circuit precision is maintained for load currents ranging from the reference's supply current, typically 85 μ A, to approximately 5 mA.

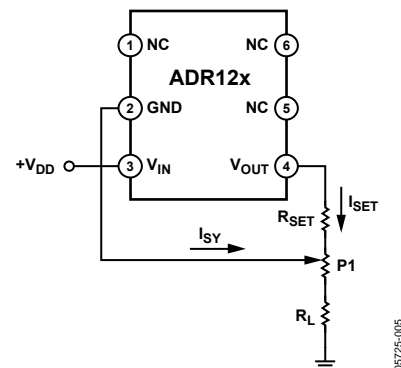
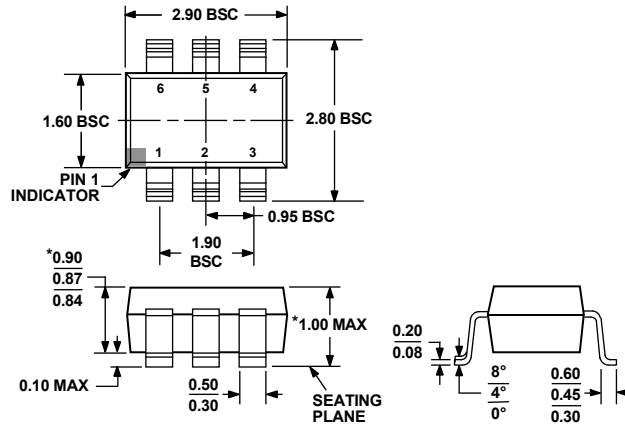

Figure 52. ADR12x Trim Configuration

ADR121/ADR125/ADR127

OUTLINE DIMENSIONS



*COMPLIANT TO JEDEC STANDARDS MO-193-AA WITH THE EXCEPTION OF PACKAGE HEIGHT AND THICKNESS.

Figure 53. 6-Lead Thin Small Outline Transistor Package [TSOT] (UJ-6)

Dimensions shown in millimeters

ORDERING GUIDE

Model	Output Voltage (V _{out})	Initial Accuracy		Temperature Coefficient (ppm/°C)	Temperature Range	Package Description	Package Option	Ordering Quantity	Branding
		mV	±%						
ADR121AUJZ-REEL7 ¹	2.5	2.5	0.24	25	-40°C to +125°C	6-Lead TSOT	UJ-6	3,000	R0N
ADR121AUJZ-R2 ¹	2.5	2.5	0.24	25	-40°C to +125°C	6-Lead TSOT	UJ-6	250	R0N
ADR121BUJZ-REEL7 ¹	2.5	2.5	0.12	9	-40°C to +125°C	6-Lead TSOT	UJ-6	3,000	R0P
ADR125AUJZ-REEL7 ¹	5.0	5.0	0.24	25	-40°C to +125°C	6-Lead TSOT	UJ-6	3,000	R0Q
ADR125AUJZ-R2 ¹	5.0	5.0	0.24	25	-40°C to +125°C	6-Lead TSOT	UJ-6	250	R0Q
ADR125BUJZ-REEL7 ¹	5.0	5.0	0.12	9	-40°C to +125°C	6-Lead TSOT	UJ-6	3,000	R0R
ADR127AUJZ-REEL7 ¹	1.25	3	0.24	25	-40°C to +125°C	6-Lead TSOT	UJ-6	3,000	R0S
ADR127AUJZ-R2 ¹	1.25	3	0.24	25	-40°C to +125°C	6-Lead TSOT	UJ-6	250	R0S
ADR127BUJZ-REEL7 ¹	1.25	1.5	0.12	9	-40°C to +125°C	6-Lead TSOT	UJ-6	3,000	R0T

¹ Z = RoHS Compliant Part.

NOTES

ADR121/ADR125/ADR127

NOTES