

LM32

Dual Thermal Diode Temperature Sensor with SensorPath™ Bus

General Description

The LM32 is a digital temperature sensor that measures 3 temperature zones and has a single-wire interface compatible with National Semiconductor's SensorPath bus. SensorPath data is pulse width encoded, thereby allowing the LM32 to be easily connected to many general purpose micro-controllers. Several National Semiconductor Super I/O products include a fully integrated SensorPath master, that when connected to an LM32 can realize a hardware monitor function that includes limit checking for measured values, autonomous fan speed control and many other functions.

The LM32 measures the temperature of its own die as well as two external devices such as a processor thermal diode or a diode connected transistor. The LM32 can resolve temperatures up to 255°C and down to -256°C. The operating temperature range of the LM32 is 0°C to +125°C. The address programming pin allows two LM32s to be placed on one SensorPath bus.

Features

- SensorPath Interface
 - 2 hardware programmable addresses

- 2 remote diode temperature sensor zones
- Internal local temperature zone
- 0.5 °C resolution
- Measures temperatures up to 140 °C
- 14-lead TSSOP package

Key Specifications

- Temperature Sensor Accuracy ±3 °C (max)
- Temperature Range:
 - LM32 junction 0 °C to +85 °C
 - Remote Temp Accuracy 0 °C to +100 °C
- Power Supply Voltage +3.0 V to +3.6 V
- Average Power Supply Current 0.5 mA (typ)
- Conversion Time (all Channels) 22.5ms to 1456ms

Applications

- Microprocessor based equipment
(Motherboards, Video Cards, Base-stations, Routers, ATMs, Point of Sale, ...)
- Power Supplies

Typical Application

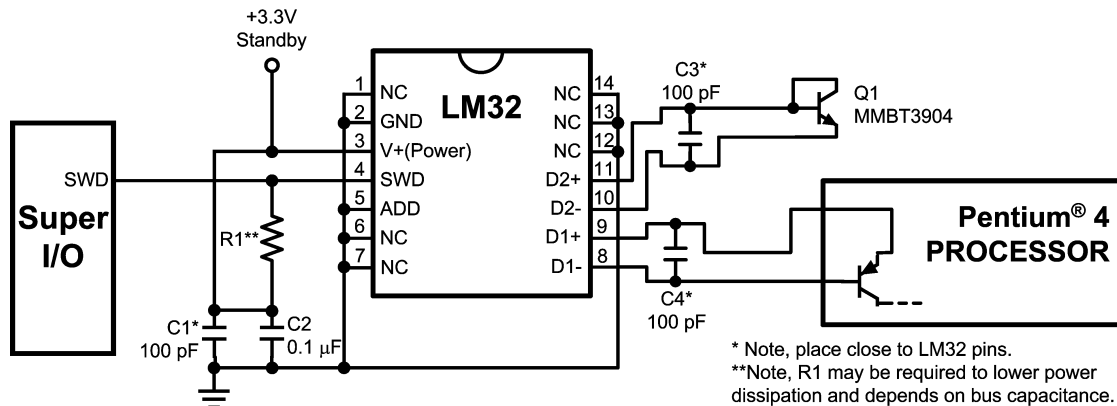

20071101

SensorPath™ is a trademark of National Semiconductor Corporation

Connection Diagram

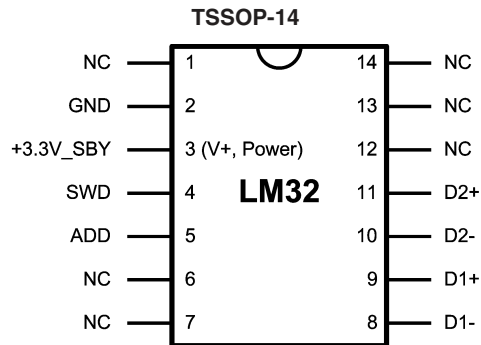

20071102

Top View
National Package Number MTC14C

Order Number	Package Marking	NS Package Number	Transport Media
LM32CIMT	LM32 CIMT	MTC14C	94 units per rail
LM32CIMTX	LM32 CIMT	MTC14C	2500 units in tape and reel

Pin Description

Pin Number	Pin Name	Description	Typical Connection
1, 6, 7, 12, 13, 14	NC	No Connect	May be tied to V+, GND or left floating
2	GND	Ground	System ground
3	V+ / +3.3V_SBY	Positive power supply pin	Connected system 3.3 V standby power and to a 0.1 μ F bypass capacitor in parallel with 100 pF. A bulk capacitance of approximately 10 μ F needs to be in the near vicinity of the LM32.
4	SWD	SensorPath Bus line; Open-drain output	Super I/O, Pull-up resistor, 1.6k
5	ADD	Digital input - device number select input for the serial bus device number	Pull-up to 3.3 V or pull-down to GND resistor, 10k; must never be left floating
8, 10	D1-, D2-	Thermal diode analog voltage output and negative monitoring input	Remote Thermal Diode cathode (THERM_DC) - Diode 1 should always be connected to the processor thermal diode. Diode 2 may be connected to an MMBT3904 or GPU thermal diode. A 100 pF capacitor should be connected between respective D- and D+ for noise filtering.
9, 11	D1+, D2+	Thermal diode analog current output and positive monitoring input	Remote Thermal Diode anode (THERM_DA) - Diode 1 should always be connected to the processor thermal diode. Diode 2 may be connected to an MMBT3904 or GPU thermal diode. A 100 pF capacitor should be connected between respective D- and D+ for noise filtering.

Block Diagram

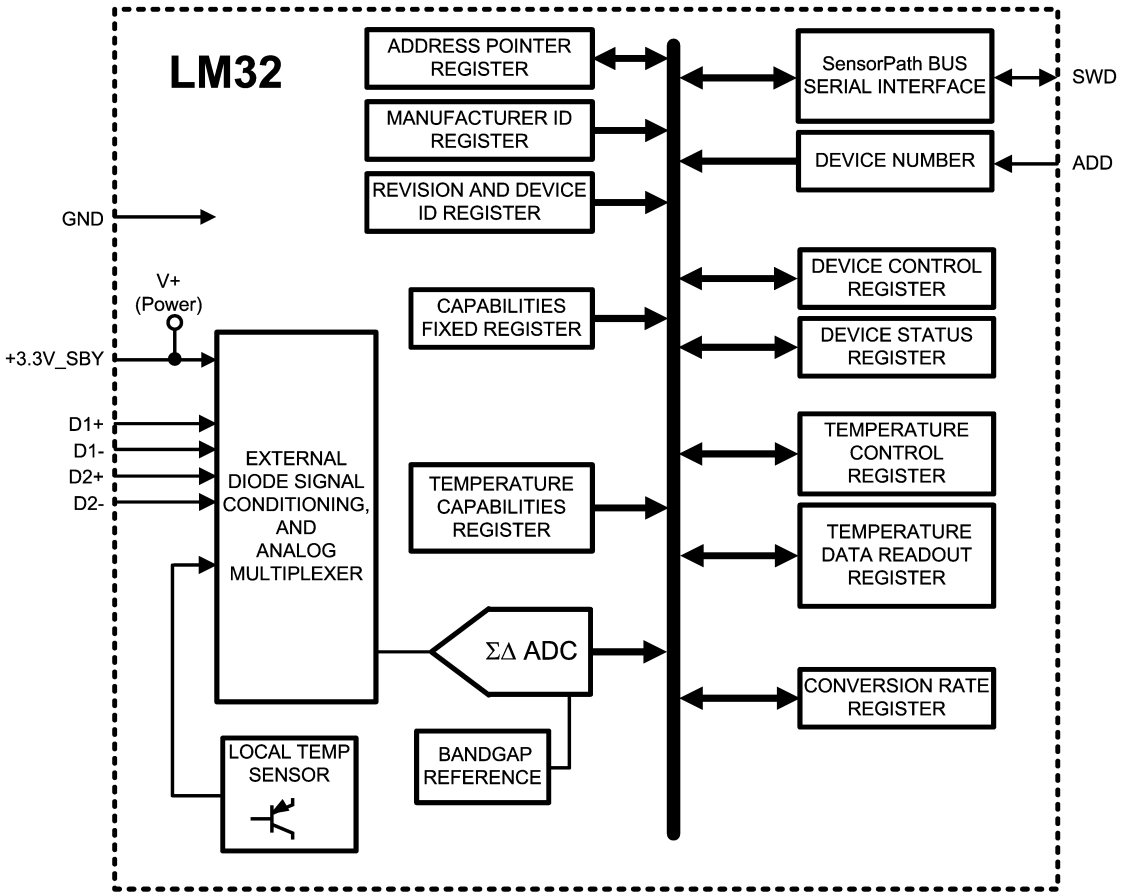

20071103

Absolute Maximum Ratings

(Notes 2, 1)

Supply Voltage (V ⁺)	-0.5 V to 6.0 V
Voltage at Any Digital Input or Output Pin	-0.5 V to 6.0 V
Voltage on D1+ and D2+	-0.5 V to (V ⁺ + 0.05 V)
Current on D1- and D2-	±1 mA
Input Current per Pin(Note 3)	±5 mA
Package Input Current (Note 3)	±30 mA
Package Power Dissipation	(Note 4)
Output Sink Current	10 mA
ESD Susceptibility (Note 5)	
Human Body Model	2500 V
Machine Model	250 V

Storage Temperature -65°C to +150°C
Soldering process must comply with National's reflow temperature profile specifications. Refer to www.national.com/packaging/. (Note 6)

Operating Ratings

(Notes 1, 2)

Temperature Range for Electrical Characteristics	
LM32CIMT (T _{MIN} ≤ T _A ≤ T _{MAX})	0°C ≤ T _A ≤ +85°C
Operating Temperature Range	0°C ≤ T _A ≤ +125°C
Remote Diode Temperature (T _D) Range	-5°C ≤ T _D ≤ +140°C
Supply Voltage Range (V ⁺)	+3.0 V to +3.6 V

DC Electrical Characteristics

The following specifications apply for V⁺ = +3.0 V_{DC} to +3.6 V_{DC}, and all analog source impedance R_S = 50 Ω unless otherwise specified in the conditions. **Boldface limits apply for LM32CIMT T_A = T_J = T_{MIN} = 0°C to T_{MAX} = 85°C**; all other limits T_A = +25°C. T_A is the ambient temperature of the LM32; T_J is the junction temperature of the LM32; T_D is the junction temperature of the remote thermal diode.

POWER SUPPLY CHARACTERISTICS

Symbol	Parameter	Conditions	Typical (Note 7)	Limits (Note 8)	Units (Limit)
V ⁺	Power Supply Voltage		3.3	3.0 3.6	V (min) V (max)
I _{Shutdown}	Shutdown Power Supply Current	SensorPath Bus Inactive (Note 9)	260	420	μA (max)
I _{Average}	Average Power Supply Current	SensorPath Bus Inactive; all sensors enabled; t _{CONV} = 182 ms; (Note 9)		900	μA (max)
I _{Peak}	Peak Power Supply Current	SensorPath Bus Inactive (Note 9)		3.3	mA (max)
	Power-On Reset Threshold Voltage			1.6	V (min)
				2.8	V (max)

TEMPERATURE-TO-DIGITAL CONVERTER CHARACTERISTICS

Parameter	Conditions		Typical (Note 7)	Limits (Note 8)	Units (Limits)
Temperature Accuracy Using the Remote Thermal Diode, see (Note 11) for Thermal Diode Processor Type.	T _J = 0°C to +85°C	T _D = +25°C	±1	±2.5	°C (max)
	T _J = 0°C to +85°C	T _D = 0°C to +100°C		±3	°C (max)
	T _J = 0°C to +85°C	T _D = +100°C to +125°C		±4	°C (max)
Temperature Accuracy Using the Local Diode	T _J = 0°C to +85°C (Note 10)		±1	±3	°C (max)
Remote Diode and Local Temperature Resolution			10		Bits
			0.5		°C
D ⁻ Source Voltage			0.7		V
Diode Source Current	(V _{D+} - V _{D-}) = +0.65 V; High Current		188	280	μA (max)
	Low Current		11.75		μA
Diode Source Current High Current to Low Current Ratio			16		

SWD and ADD DIGITAL INPUT CHARACTERISTICS

Symbol	Parameter	Conditions	Typical (Note 7)	Limits (Note 8)	Units (Limit)
V_{IH}	SWD Logical High Input Voltage			2.1	V (min)
				V+ + 0.5	V (max)
V_{IL}	SWD Logical Low Input Voltage			0.8	V (max)
				-0.5	V (min)
V_{IH}	ADD Logical High Input Voltage			90% x V+	V (min)
V_{IL}	ADD Logical Low Input Voltage			10% x V+	V (max)
V_{HYST}	Input Hysteresis		300		mV
I_L	SWD and ADD Input Current	$GND \leq V_{IN} \leq V+$	± 0.005	± 10	μA (max)
	SWD Input Current with V+ Open or Grounded	$GND \leq V_{IN} \leq 3.6V$, and V+ Open or GND	± 0.005		μA
C_{IN}	Digital Input Capacitance		10		pF

SWD DIGITAL OUTPUT CHARACTERISTICS

Symbol	Parameter	Conditions	Typical (Note 7)	Limits (Note 8)	Units (Limit)
V_{OL}	Open-drain Output Logic "Low" Voltage	$I_{OL} = 4mA$		0.4	V (max)
		$I_{OL} = 50\mu A$		0.2	V (max)
I_{OH}	Open-drain Output Off Current		± 0.005	± 10	μA (max)
C_{OUT}	Digital Output Capacitance		10		pF

AC Electrical Characteristics

The following specification apply for $V+ = +3.0 V_{DC}$ to $+3.6 V_{DC}$, unless otherwise specified. **Boldface limits apply for $T_A = T_J = T_{MIN}=0^\circ C$ to $T_{MAX}=85^\circ C$** ; all other limits $T_A = T_J = 25^\circ C$. The SensorPath Characteristics conform to the SensorPath specification revision 0.98. Please refer to that speciation for further details.

Symbol	Parameter	Conditions	Typical (Note 7)	Limits (Note 8)	Units (Limits)
--------	-----------	------------	---------------------	--------------------	-------------------

HARDWARE MONITOR CHARACTERISTICS

t_{CONV}	Total Monitoring Cycle Time (Note 12)	All Temperature readings (Default)	182	163.8	ms (min)
				200.2	ms (max)

SensorPath Bus CHARACTERISTICS

t_f	SWD fall time (Note 15)	$R_{pull-up}=1.25 k\Omega \pm 30\%$, $C_L=400 pF$		300	ns (max)
t_r	SWD rise time (Note 15)	$R_{pull-up}=1.25 k\Omega \pm 30\%$, $C_L=400 pF$		1000	ns (max)
t_{INACT}	Minimum inactive time (bus at high level) guaranteed by the slave before an attention request			11	μs (min)
t_{Mtr0}	Master drive for Data Bit 0 write and for Data Bit 0-1 read			11.8	μs (min)
				17.0	μs (max)
t_{Mtr1}	Master drive for Data Bit 1 write			35.4	μs (min)
				48.9	μs (max)
t_{SFEdet}	Time allowed for LM32 activity detection			9.6	μs (max)
t_{SLOut1}	LM32 drive for Data Bit 1 read by master			28.3	μs (min)
				38.3	μs (max)
t_{MtrS}	Master drive for Start Bit			80	μs (min)
				109	μs (max)
t_{SLOutA}	LM32 drive for Attention Request			165	μs (min)
				228	μs (max)
t_{RST}	Master or LM32 drive for Reset			354	μs (min)

AC Electrical Characteristics (Continued)

The following specification apply for $V_+ = +3.0 V_{DC}$ to $+3.6 V_{DC}$, unless otherwise specified. **Boldface limits apply for $T_A = T_J = T_{MIN}=0^\circ C$ to $T_{MAX}=85^\circ C$** ; all other limits $T_A = T_J = 25^\circ C$. The SensorPath Characteristics conform to the SensorPath specification revision 0.98. Please refer to that speciation for further details.

Symbol	Parameter	Conditions	Typical (Note 7)	Limits (Note 8)	Units (Limits)
t_{RST_MAX}	Maximum drive of SWD by an LM32, after the power supply is raised above 3V			500	ms (max)

Note 1: Absolute Maximum Ratings indicate limits beyond which damage to the device may occur. Operating Ratings indicate conditions for which the device is functional, but do not guarantee performance limits. For guaranteed specifications and test conditions, see the Electrical Characteristics. The guaranteed specifications apply only for the test conditions listed. Some performance characteristics may degrade when the device is not operated under the listed test conditions.

Note 2: All voltages are measured with respect to GND, unless otherwise noted.

Note 3: When the input voltage (V_{IN}) at any pin exceeds the power supplies ($V_{IN} < GND$ or $V_{IN} > V_+$), the current at that pin should be limited to 5 mA. Parasitic components and/or ESD protection circuitry are shown below for the LM32's pins. The nominal breakdown voltage of the zener is 6.5 V. SNP stands for snap-back device.

PIN #	Pin Name	Pin Circuit	All Input Structure Circuits
1	NC	A	
2	GND	B	
3	V+/ 3.3V SB	B	
4	SWD	A	
5	ADD	A	
6	NC	none	
7	NC	none	
8	D1-	C	
9	D1+	D	
10	D2-	C	
11	D2+	D	
12	NC	none	
13	NC	none	
14	NC	A	

Note 4: Thermal resistance junction-to-ambient in still air when attached to a printed circuit board with 1 oz. foil is 148 °C/W.

Note 5: Human body model, 100 pF discharged through a 1.5 kΩ resistor. Machine model, 200 pF discharged directly into each pin.

Note 6: Reflow temperature profiles are different for lead-free and non lead-free packages.

Note 7: "Typicals" are at $T_A = 25^\circ C$ and represent most likely parametric norm. They are to be used as general reference values not for critical design calculations.

Note 8: Limits are guaranteed to National's AOQL (Average Outgoing Quality Level).

Note 9: The supply current will not increase substantially with a SensorPath transaction.

Note 10: Local temperature accuracy does not include the effects of self-heating. The rise in temperature due to self-heating is the product of the internal power dissipation of the LM32 and the thermal resistance. See (Note 4) for the thermal resistance to be used in the self-heating calculation.

Note 11: The accuracy of the LM32CIMT is guaranteed when using the thermal diode of an Intel 90 nm Pentium 4 processor or any thermal diode with a non-ideality factor of 1.011 and series resistance of 3.33Ω. When using a MMBT3904 type transistor as a thermal diode the error band will be typically shifted by -4.5 °C.

Note 12: This specification is provided only to indicate how often temperature data are updated.

Note 13: The output fall time is measured from ($V_{IH\ min}$) to ($V_{IL\ max}$).

Note 14: The output rise time is measured from ($V_{IL\ max}$) to ($V_{IH\ min}$).

Note 15: The rise and fall times are not tested but guaranteed by design.

Timing Diagrams

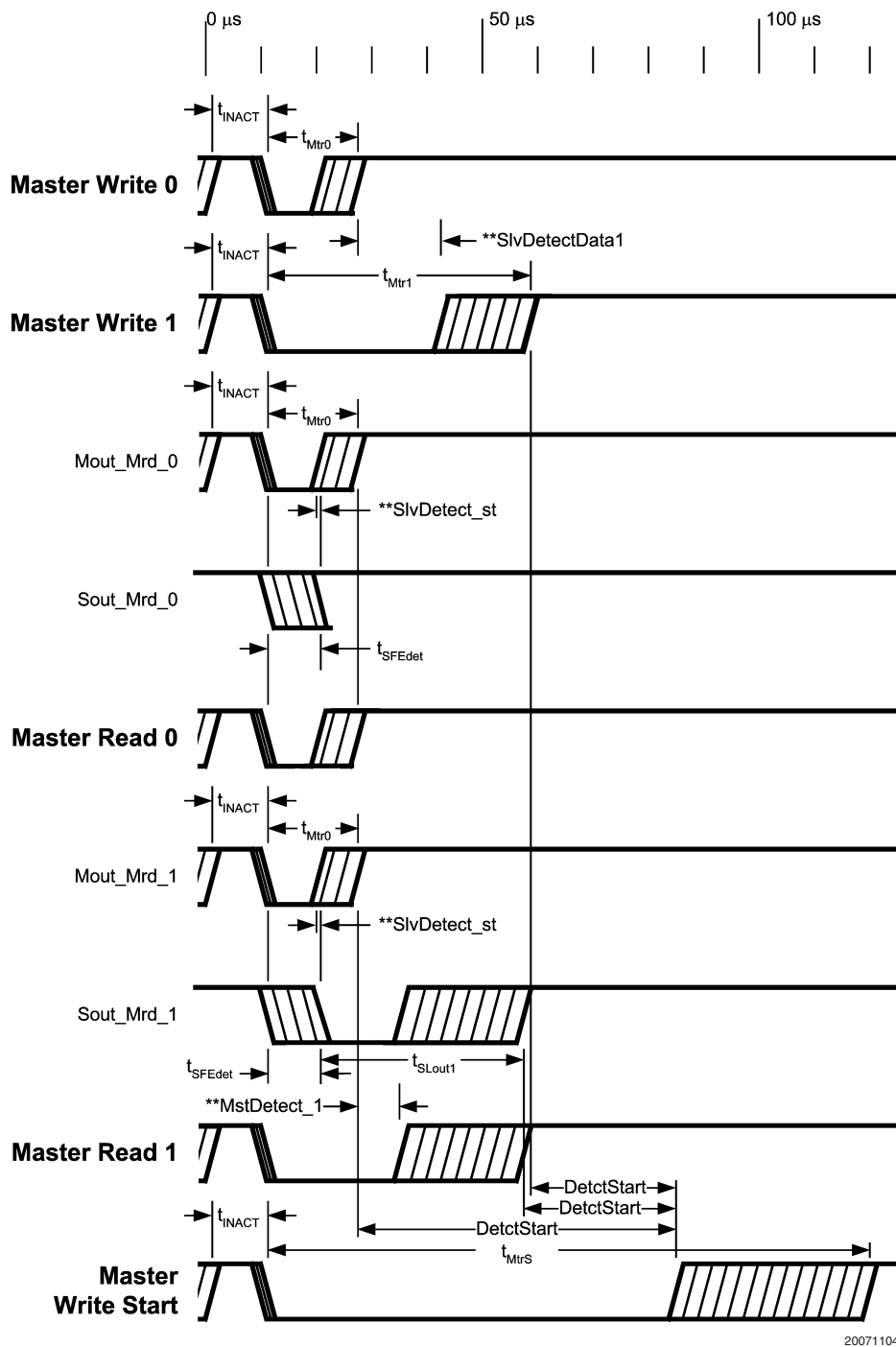

20071104

FIGURE 1. Timing for Data Bits 0, 1 and Start Bit. See Section 1.2 "SensorPath BIT SIGNALING" for further details.

Timing Diagrams (Continued)

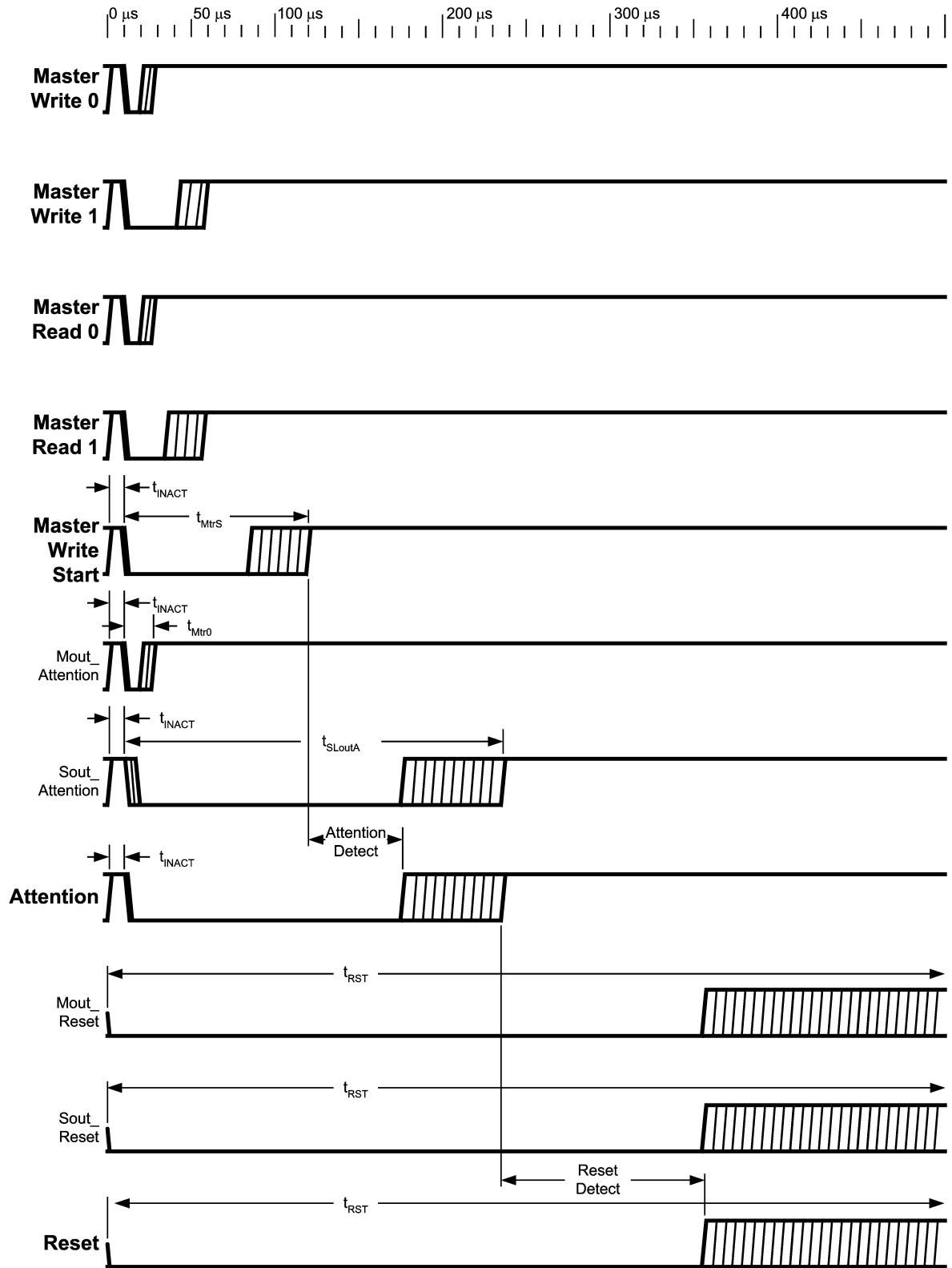

20071105

FIGURE 2. Timing for Attention Request and Reset. See Section 1.2 "SensorPath BIT SIGNALING" for further details.

Typical Performance Characteristics

Remote Diode Temperature Reading Sensitivity to Diode Filter Capacitance

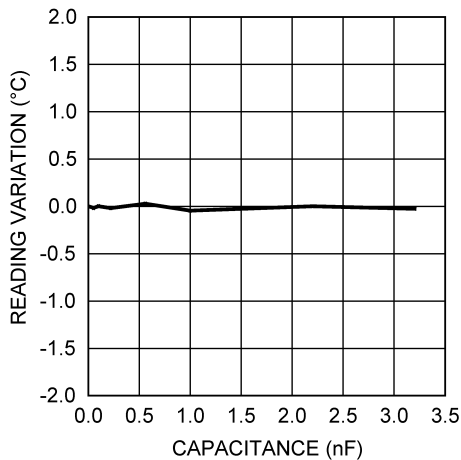

20071121

Thermal Diode Capacitor or PCB Leakage Current Effect on Remote Diode Temperature Reading

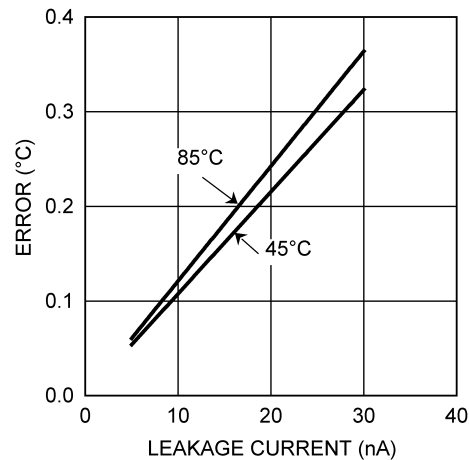

20071122

1.0 Functional Description

The LM32 measures 3 temperature zones. The LM32 uses a ΔV_{be} temperature sensing method. A differential voltage, representing temperature, is digitized using a Sigma-Delta analog to digital converter. The digitized data can be retrieved over a simple single-wire interface called SensorPath. SensorPath has been defined by National Semiconductor and is optimized for hardware monitoring. National offers a royalty-free license in connection with its intellectual property rights in the SensorPath bus.

The LM32 has one address pin to allow up to two LM32s to be connected to one SensorPath bus. The physical interface of SensorPath's SWD signal is identical to the familiar industry standard SMBus SMBDAT signal. The digital information is encoded in the pulse width of the signal being transmitted. Every bit can be synchronized by the master simplifying the implementation of the master when using a micro-controller. For micro-controller's with greater functionality an asynchronous attention signal can be transmitted by the LM32 to interrupt the micro-controller and notify it that temperature data has been updated in the readout registers.

To optimize the LM32's power consumption to the system requirements, the LM32 has a shutdown mode and supports multiple conversion rates.

1.1 SensorPath BUS SWD

SWD is the Single Wire Data line used for communication. SensorPath uses 3.3V single-ended signaling, with a pull-up resistor and open-drain low-side drive (see Figure 3). For timing purposes SensorPath is designed for capacitive loads (C_L) of up to 400pF. Note that in many cases a 3.3V standby rail of the PC will be used as a power supply for both the sensor and the master. Logic high and low voltage levels for SWD are TTL compatible. The master may provide an internal pull-up resistor. In this case the external resistor is not needed. The minimum value of the pull-up resistor must take into account the maximum allowable output load current of 4mA.

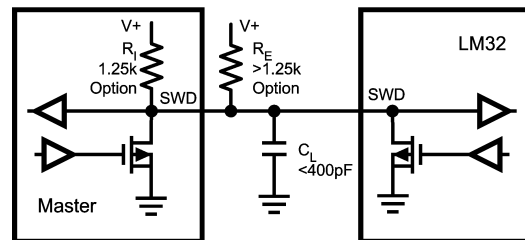

20071107

FIGURE 3. SensorPath SWD simplified schematic

1.2 SensorPath BIT SIGNALING

Signals are transmitted over SensorPath using pulse-width encoding. There are five types of "bit signals":

- Data Bit 0
- Data Bit 1
- Start Bit
- Attention Request
- Reset

All the "bit signals" involve driving the bus to a low level. The duration of the low level differentiates between the different "bit-signals". Each "bit signal" has a fixed pulse width. SensorPath supports a Bus Reset Operation and Clock Training sequence that allows the slave device to synchronize its internal clock rate to the master. Since the LM32 meets the $\pm 15\%$ timing requirements of SensorPath, the LM32 does not require the Clock Training sequence and does not support this feature. This section defines the "bit signal" behavior in all the modes. Please refer to the timing diagrams in the Electrical Characteristics section (Figure 1 and Figure 2) while going through this section. Note that the timing diagrams for the different types of "bit signals" are shown together to better highlight the timing relationships between them. However, the different types of "bit signals" appear on SWD at different points in time. These timing diagrams show the signals as driven by the master and the LM32 slave as well as the signal as seen when probing SWD. Signal labels that begin with the label Mout_ depict a drive by the master.

1.0 Functional Description (Continued)

Signal labels that begin with the label Slv_ depict the drive by the LM32. All other signals show what would be seen when probing SWD for a particular function (e.g. "Master Wr 0" is the Master transmitting a Data Bit with the value of 0).

1.2.1 Bus Inactive

The bus is inactive when the SWD signal is high for a period of at least t_{INACT} . The bus is inactive between each "bit signal".

1.2.2 Data Bit 0 and 1

All Data Bit signal transfers are started by the master. A Data Bit 0 is indicated by a "short" pulse; a Data Bit 1 is indicated by a longer pulse. The direction of the bit is relative to the master, as follows:

- Data Write - a Data Bit transferred from the master to the LM32.
- Data Read - a Data Bit transferred from the LM32 to the master.

A master must monitor the bus as inactive before starting a Data Bit (Read or Write).

A master initiates a data write by driving the bus active (low level) for the period that matches the data value (t_{Mtr0} or t_{Mtr1} for a write of "0" or "1", respectively). The LM32 will detect that the SWD becomes active within a period of t_{SFEdet} , and will start measuring the duration that the SWD is active in order to detect the data value.

A master initiates a data read by driving the bus for a period of t_{Mtr0} . The LM32 will detect that the SWD becomes active within a period of t_{SFEdet} . For a data read of "0", the LM32 will not drive the SWD. For a data read of "1" the LM32 will start within t_{SFEdet} to drive the SWD low for a period of t_{SLOut1} . Both master and LM32 must monitor the time at which the bus becomes inactive to identify a data read of "0" or "1".

During each Data Bit, both the master and all the LM32s must monitor the bus (the master for Attention Request and Reset; the LM32s for Start Bit, Attention Request and Reset) by measuring the time SWD is active (low). If a Start Bit, Attention Requests or Reset "bit signal" is detected, the current "bit signal" is not treated as a Data Bit.

Note that the bit rate of the protocol varies depending on the data transferred. Thus, the LM32 has a value of "0" in reserved or unused register bits for bus bandwidth efficiency.

1.2.3 Start Bit

A master must monitor the bus as inactive before beginning a Start Bit.

The master uses a Start Bit to indicate the beginning of a transfer. LM32s will monitor for Start Bits all the time, to allow synchronization of transactions with the master. If a Start Bit occurs in the middle of a transaction, the LM32 being addressed will abort the current transaction. In this case the transaction is not "completed" by the LM32 (see *Section 1.3 "SensorPath Bus Transactions"*).

During each Start Bit, both the master and all the LM32s must monitor the bus for Attention Request and Reset, by

measuring the time SWD is active (low). If an Attention Request or Reset condition is detected, the current "bit signal" is not treated as a Start Bit. The master may attempt to send the Start Bit at a later time.

1.2.4 Attention Request

The LM32 may initiate an Attention Request when the SensorPath bus is inactive.

Note that a Data Bit, or Start Bit, from the master may start simultaneously with an Attention Request from the LM32. In addition, two LM32s may start an Attention Request simultaneously. Due to its length, the Attention Request has priority over any other "bit signal", except Reset. Conflict with Data Bits and Start Bits are detected by all the devices, to allow the bits to be ignored and re-issued by their originator.

The LM32 will either check to see that the bus is inactive before starting an Attention Request, or start the Attention Request within the t_{SFEdet} time interval after SWD becomes active. The LM32 will drive the signal low for t_{SLOutA} time. After this, both the master and the LM32 must monitor the bus for a Reset Condition. If a Reset condition is detected, the current "bit signal" is not treated as an Attention Request.

After Reset, an Attention Request can not be sent before the master has sent 14 Data Bits on the bus. See *Section 1.3.5* for further details on Attention Request generation.

1.2.5 Bus Reset

The LM32 issues a Reset at power up. The master must also generate a Bus Reset at power-up for at least the minimum reset time, it must not rely on the LM32. SensorPath puts no limitation on the maximum reset time of the master. Following a Bus Reset, the LM32 may generate an Attention Request only after the master has sent 14 Data Bits on the bus. See *Section 1.3.5* for further details on Attention Request generation.

1.3 SensorPath BUS TRANSACTIONS

SensorPath is designed to work with a single master and up to seven slave devices. Each slave has a unique address. The LM32 supports up to 2 device addresses that are selected by the state of the address pin ADD. The Register Set of the LM32 is defined in *Section 2.0*.

1.3.1 Bus Reset Operation

A Bus Reset Operation is global on the bus and affects only the communication interface of all the devices connected to it. The Bus Reset operation does not affect either the contents of the device registers, or device operation, to the extent defined in LM32 Register Set, see *Section 2.0*.

The Bus Reset operation is performed by generating a Reset signal on the bus. The master must apply Reset after power-up, and before it starts operation. The Reset signal end will be monitored by all the LM32s on the bus.

After the Reset Signal the SensorPath specification requires that the master send a sequence of 8 Data Bits with a value of "0", without a preceding Start Bit. This is required to enable slaves that "train" their clocks to the bit timing. The LM32 does not require nor does it support clock training.

1.0 Functional Description (Continued)

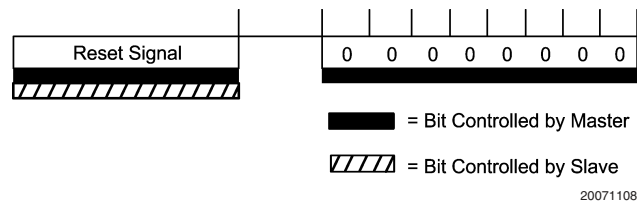

FIGURE 4. Bus Reset Transaction

1.3.2 Read Transaction

During a read transaction, the master reads data from a register at a specified address within a slave. A read transaction begins with a Start Bit and ends with an ACK bit, as shown in *Figure 5*.

- **Device Number** This is the address of the LM32 device accessed. Address "000" is a broadcast address and can be responded to by all the slave devices. The LM32 ignores the broadcast address during a read transaction.
- **Internal Address** The address of a register within the LM32 that is read.
- **Read/Write (R/W)** A "1" indicates a read transaction.
- **Data Bits** During a read transaction the data bits are driven by the LM32. Data is transferred serially with the most significant bit first. This allows throughput optimization based on the information that needs to be read.
The LM32 supports 8-bit or 16-bit data fields, as described in *Section 2.0* "Register Set".
- **Even Parity (EP)** This bit is based on all preceding bits (device number, internal address, Read/Write and data bits) and the parity bit itself. The parity -number of 1's - of all the preceding bits and the parity bit must be even - i.e., the result must be 0. During a read transaction, the EP bit is sent by the LM32 to the master to allow the master to check the received data before using it.

- **Acknowledge (ACK)** During a read transaction the ACK bit is sent by the master indicating that the EP bit was received and was found to be correct, when compared to the data preceding it, and that no conflict was detected on the bus (excluding Attention Request - see *Section 1.3.5* "Attention Request Transaction"). A read transfer is considered "complete" only when the ACK bit is received. A transaction that was not positively acknowledged is not considered "complete" by the LM32 and following are performed:

- The BER bit in the LM32 Device Status register is set
- The LM32 generates an Attention Request before, or together with the Start Bit of the next transaction

A transaction that was not positively acknowledged is also not considered "complete" by the master (i.e. internal operations related to the transaction are not performed). The transaction may be repeated by the master, after detecting the source of the Attention Request (the LM32 that has a set BER bit in the Device Status register). Note that the SensorPath protocol neither forces, nor automates re-execution of the transaction by the master.

The values of the ACK bit are:

- 1: Data was received correctly
- 0: An error was detected (no-acknowledge).

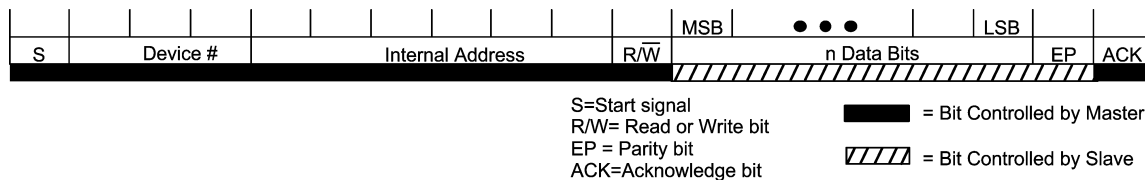

FIGURE 5. Read Transaction, master reads data from LM32

1.3.3 Write Transaction

In a write transaction, the master writes data to a register at a specified address in the LM32. A write transaction begins with a Start Bit and ends with an ACK Data Bit, as show in *Figure 6*.

- **Device Number** This is the address of the slave device accessed. Address "000" is a broadcast address and is responded to by all the slave devices. The LM32 responds to broadcast messages to the Device Control Register.

- **Internal Address** This is the register address in the LM32 that will be written.
- **Read/Write (R/W)** A "0" data bit directs a write transaction.

1.0 Functional Description (Continued)

- **Data Bits** This is the data written to the LM32 register, are driven by the master. Data is transferred serially with the most significant bit first. The number of data bits may vary from one address to another, based on the size of the register in the LM32. This allows throughput optimization based on the information that needs to be written. The LM32 supports 8-bit or 16-bit data fields, as described in *Section 2.0 "Register Set"*.
- **Even Parity (EP)** This data bit is based on all preceding bits (Device Number, Internal Address, Read/Write and Data bits) and the Even Parity bit itself. The parity (number of 1's) of all the preceding bits and the parity bit must be even - i.e. the result must be 0. During a write transaction, the EP bit is sent by the master to the LM32 to allow the LM32 to check the received data before using it.
- **Acknowledge (ACK)** During the write transaction the ACK bit is sent by the LM32 indicating to the master that the EP was received and was found correct, and that no conflict was detected on the bus (excluding Attention

Request - see *Section 1.3.5 "Attention Request Transaction"*). A write transfer is considered "completed" only when the ACK bit is generated. A transaction that was not positively acknowledged is not considered complete by the LM32 (i.e. internal operation related to the transaction are not performed) and the following are performed:

- The BER bit in the LM32 Device Status register is set;
- The LM32 generates an Attention Request before, or together with the Start Bit of the next transaction

A transaction that was not positively acknowledged is also not considered "complete" by the master (i.e. internal operations related to the transaction are not performed). The transaction may be repeated by the master, after detecting the source of the Attention Request (the LM32 that has a set BER bit in the Device Status register). Note that the SensorPath protocol neither forces, nor automates re-execution of the transaction by the master.

The values of the ACK bit are:

- 1: Data was received correctly;
- 0: An error was detected (no-acknowledge).

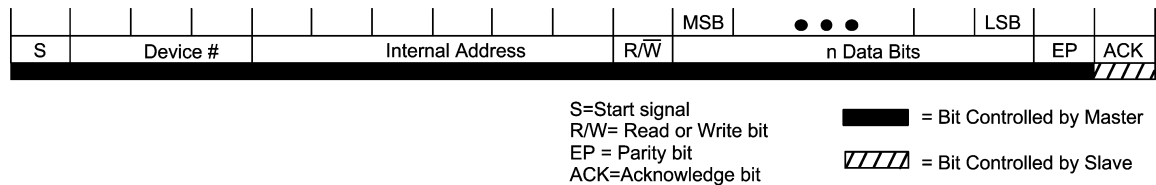

20071110

FIGURE 6. Write Transaction, master write data to LM32

1.3.4 Read and Write Transaction Exceptions

This section describes master and LM32 handling of special bus conditions, encountered during either Read or Write transactions.

If an LM32 receives a Start Bit in the middle of a transaction, it aborts the current transaction (the LM32 does not "complete" the current transaction) and begins a new transaction. Although not recommend for SensorPath normal operation, this situation is legitimate, therefore it is not flagged as an error by the LM32 and Attention Request is not generated in response to it. The master generating the Start Bit, is responsible for handling the not "complete" transaction at a "higher level".

If LM32 receives more than the expected number of data bits (defined by the size of the accessed register), it ignores the unnecessary bits. In this case, if both master and LM32 identify correct EP and ACK bits they "complete" the transaction. However, in most cases, the additional data bits differ from the correct EP and ACK bits. In this case, both the master and the LM32 do not "complete" the transaction. In addition, the LM32 performs the following:

- the BER bit in the LM32 Device Status register is set
- the LM32 generates an Attention Request

If the LM32 receives less than the expected number of data bits (defined by the size of the accessed register), it waits indefinitely for the missing bits to be sent by the master. If then the master sends the missing bits, together with the correct EP/ACK bits, both master and LM32 "complete" the transaction. However, if the master starts a new transaction

generating a Start Bit, the LM32 aborts the current transaction (the LM32 does not "complete" the current transaction) and begins the new transaction. The master is not notified by the LM32 of the incomplete transaction.

1.3.5 Attention Request Transaction

Attention Request is generated by the LM32 when it needs the attention of the master. The master and all LM32s must monitor the Attention Request to allow bit re-sending in case of simultaneous start with a Data Bit or Start Bit transfer. Refer to the "Attention Request" section, *Section 1.2.4* in the "Bit Signaling" portion of the data sheet.

The LM32 will generate an Attention Request using the following rules:

1. A Function event that sets the Status Flag has occurred and Attention Request is enabled **and**
2. The "physical" condition for an Attention Request is met (i.e., the bus is inactive), **and**
3. At the first time 2 is met after 1 occurred, there has not been an Attention request on the bus since a read of the Device Status register, **or** since a Bus Reset.

OR

1. A bus error event occurred, **and**
2. the "physical" condition for an Attention Request is met (i.e., the bus is inactive), **and**
3. At the first time 2. is met after 1 occurred, there has not been a Bus Reset.

1.0 Functional Description (Continued)

All devices (master or slave) must monitor the bus for an Attention Request signal. The following notes clarify the intended system operation that uses the Attention Request Indication.

- Masters are expected to use the attention request as a trigger to read results from the LM32. This is done in a sequence that covers all LM32s. This sequence is referred to as "master sensor read sequence".
- After an Attention Request is sent by an LM32 until after the next read from the Device Status register the LM32 does not send Attention Requests for a function event since it is guaranteed that the master will read the Status register as part of the master sensor read sequence. Note that the LM32 will send an attention for BER, regardless of the Status register read, to help the master with any error recovery operations and prevent deadlocks.
- A master must record the Attention Request event. It must then scan all slave devices in the system by reading

their Device Status register and must handle any pending event in them before it may assume that there are no more events to handle.

Note: there is no indication of which slave has sent the request. The requirement that multiple requests are not sent allows the master to know within one scan of register reads that there are no more pending events.

1.3.6 Fixed Device Number Setting

The LM32 device number is defined by strapping of the ADD pin. The LM32 will wake (after Device Reset) with the Device Number field of the Device Number register set to the address as designated in *Section 2.3 "Device Number"*. It is the responsibility of the system designer to avoid having two devices with the same Device Number on the bus.

Devices should be detected by the master by a read operation of the Device Number register. The read returns "000" if there is no device at that address on the bus (the EP bit must be ignored).

2.0 Register Set

2.1 REGISTER SET SUMMARY

Reg Add	Register Name	R/W	POR Val	Bit 15 MSb	Bit 14	Bit 13	Bit 12	Bit 11	Bit 10	Bit 9	Bit 8	Bit 7	Bit 6	Bit 5	Bit 4	Bit 3	Bit 2	Bit 1	Bit 0 LSB			
000 000 00h	Device Number	R	*	Not Available									Reserved					See Section 2.3				
000 001 01h	Manufacturer ID	R	100Bh	0	0	0	1	0	0	0	0	0	0	0	0	1	0	1	1			
000 010 02h	Device ID	R	23h	RevID					Device ID													
				0	0	0	0	0	0	0	0	0	0	1	0	0	0	1	1			
000 011 03h	Capabilities Fixed	R	01h	Reserved												FuncDescriptor 1 (Temperature)						
				0	0	0	0	0	0	0	0	0	0	0	0	0	0	0	1			
000 100 04h	Device Status	R	0h	Not Available								BER	Reserved		ERF1	Reserved			SF1			
													0	0		0	0	0				
000 101 05h	Device Control	R/W	0h	Reserved											EnF1	Res	Low Pwr	Shut down	Re set			
				0	0	0	0	0	0	0	0	0	0	0	0	0	0	0	0			
001 000 08h	Temperature Capabilities	R	0549h	Reserved				# of Remotes			Int Sens	Rout Size	Sign	10-Bits			0.5°C Resolution					
				0	0	0	0	0	1	0	1	0	1	0	0	1	0	0	1			
001 001 09h	Processor/Remote Temperature Data Readout	R		MSb Sign	128 °C	64°C	32°C	16°C	8°C	4°C	2°C	1 °C	LSb 0.5 °C	Res		SNUM	EF	Res				
	0													0	0							
	Res													Res								
	0													0	0							
001 010 0Ah	Temperature Control	R/W	0h	Reserved												EN2	EN1	EN0	ATE			
				0	0	0	0	0	0	0	0	0	0	0	0	0	0	0				
001 011 -011 111 0Bh-1Fh	Reserved	R		Undefined																		
100 000 20h	Conversion Rate	R/W	2h	Not Available								Reserved						CR1	CR0			
100 001 -111 111 21h-3Fh	Undefined Registers	R		Undefined																		

* Depends on state of ADD pins see Section 2.3 "Device Number".

2.2 DEVICE RESET OPERATION

A Device Reset operation is performed in the following conditions:

- At device power-up.
- When the Reset bit in the Device Control register is set to 1 (see Section 2.8 "Device Control").

The Device Reset operation performs the following:

- Aborts any device operation in progress and restarts device operation.
- Sets all device registers to their "Reset" (default) value.

2.3 DEVICE NUMBER (Addr: 000 000; 00h)

This register is used to specify a unique address for each device on the bus.

2.0 Register Set (Continued)

Reg Add	Register Name	R/ W	P O R Val	Bit 7	Bit 6	Bit 5	Bit 4	Bit 3	Bit 2	Bit 1	Bit 0 LSb
000 000	Device Number	R	7h or 1h	Reserved					AS2	AS1	AS0
				0	0	0	0	0			

The value of [AS2:AS0] is determined by the setting of the ADD input pin:

TABLE 1. Device Number Assignment

ADD	[AS2:AS0]
0	001
1	111

The value of [AS2:AS0] will directly change and follow the value determined by ADD. Since this is a read only register the value of the address cannot be changed by software.

2.4 MANUFACTURER ID (Addr: 000 001; 01h)

Reg Add	Register Name	R/ W	P O R Val	Bit 15 MSb	Bit 14	Bit 13	Bit 12	Bit 11	Bit 10	Bit 9	Bit 8	Bit 7	Bit 6	Bit 5	Bit 4	Bit 3	Bit 2	Bit 1	Bit 0 LSb
000 001	Manufacturer ID	R	100Bh	0	0	0	1	0	0	0	0	0	0	0	0	1	0	1	1

The manufacturer ID matches that assigned to National Semiconductor by the PCI SIG. This register may be used to identify the manufacturer of the device in order to perform manufacturer specific operations.

2.0 Register Set (Continued)

2.5 DEVICE ID (Addr: 000 010; 02h)

Reg Add	Register Name	R/W	POR Val	Bit 15 MSb	Bit 14	Bit 13	Bit 12	Bit 11	Bit 10	Bit 9	Bit 8	Bit 7	Bit 6	Bit 5	Bit 4	Bit 3	Bit 2	Bit 1	Bit 0 LSB	
000 010	Device ID	R	23h	RevID					DeviceID											
				0	0	0	0	0	0	0	0	0	0	0	1	0	0	0	1	1

The device ID is defined by the manufacturer of the device and is unique for each device produced by a manufacturer. Bits 15-11 identify the revision number of the die and will be incremented upon revision of the device.

Bit	Type	Description
10-0	RO	DeviceID (Device ID Value) A fixed value that identifies the device.
15-11	RO	RevID (Revision ID Value) A fixed value that identifies the device revision.

2.6 CAPABILITIES FIXED (Addr: 000 011; 03h)

Reg Add	Register Name	R/W	POR Val	Bit 15 MSb	Bit 14	Bit 13	Bit 12	Bit 11	Bit 10	Bit 9	Bit 8	Bit 7	Bit 6	Bit 5	Bit 4	Bit 3	Bit 2	Bit 1	Bit 0 LSB	
000 011	Capabilities Fixed	R	1h	Reserved												FuncDescriptor1				
				0	0	0	0	0	0	0	0	0	0	0	0	0	0	0	0	1

The value of this register defines the capabilities of the LM32. The LM32 supports one function, that of Temperature Measurement type. Please refer to the SensorPath specification for further details on other FuncDescriptor values.

2.7 DEVICE STATUS (Addr: 000 100; 04h)

This register is set to the reset value by a Device Reset.

Reg Add	Register Name	R/W	POR Val	Bit 7	Bit 6	Bit 5	Bit 4	Bit 3	Bit 2	Bit 1	Bit 0 LSB
000 100	Device Status	R	0h	BER	Res		ERF1	Res			SF1
					0	0		0	0	0	

Bit	Type	Description
0	RO	SF1 (Status Function 1) This bit is set by a Function Event within Function 1. Event details are function dependent and are described within the function. SF1 is cleared by Device Reset or by handling the event within the Temperature Measurement Function (see <i>Section 2.9</i> for further details). 0: Status flag for Function 1 is inactive (no event). 1: Status flag for Function 1 is active indicating that a Function Event has occurred.
3-1	RO	Reserved. Will always read "0".
4	RO	ERF1 (Error Function 1) This bit is set in response to an error indication within Function 1. ERF1 is cleared by Device Reset or by handling the error condition within the Temperature Measurement Function (see <i>Section 2.9</i> for further details). 0: No error occurred in Function 1. 1: Error occurred in Function 1.
6-5	RO	Reserved. Will always read "0".
7	RO	BER (Bus Error) This bit is set when the device either generates, or receives an error indication in the ACK bit of the transaction (i.e., no-acknowledge). BER is cleared by Device Reset or by reading the Device Status register. 0: No transaction error occurred. 1: An ACK bit error (no-acknowledge) occurred during the last transaction.

2.0 Register Set (Continued)

2.8 DEVICE CONTROL (Addr: 000 101; 05h)

This register responds to a broadcast write command (Device Number 000). Write using broadcast address is ignored by bits 15-2. This register is set to the reset value by a Device Reset.

Reg Add	Register Name	R/W	POR Val	Bit 15 MSb	Bit 14	Bit 13	Bit 12	Bit 11	Bit 10	Bit9	Bit 8	Bit 7	Bit 6	Bit 5	Bit 4	Bit 3	Bit 2	Bit 1	Bit 0 LSb
000 101	Device Control	R/W	0h	Reserved											EnF1	Res	Low Pwr	Shut down	Re set
				0	0	0	0	0	0	0	0	0	0	0					

Bit	Type	Description
0	R/W	Reset (Device Reset). When set to "1" this bit initiates a Device Reset operation (See <i>Section 2.2</i>). This bit self-clears after the Device Reset operation is completed. 0: Normal device operation. (default) 1: Device Reset The LM32 does not require a Device Reset command after power.
1	R/W	Shutdown (Shutdown Mode). When set to "1" this bit stops the operation of all functions and places the device in the lowest power consumption mode. 0: Device in Active Mode. (default) 1: Device in Shutdown Mode.
2	R/W	LowPwr (Low-Power Mode). When set to "1" this bit slows the operation of all functions and places the device in a low power consumption mode. In Low-Power Mode, the conversion rate of the LM32 is effected see <i>Section 2.10</i> for further details. 0: Device in Active Mode. (default) 1: Device in Low-Power Mode.
3	RO	Not supported. Will always read "0".
4	R/W	EnF1 (Enable Function 1). When bit is set to "1" this bit Function 1 is enabled for operation. A function may require setup before this bit is set. The function registers can be accessed even when the function is disabled. 0: Function 1 is disabled. (default) 1: Function is enabled.
15-5	RO	Not supported. Will always read "0".

2.9 TEMPERATURE MEASUREMENT FUNCTION (TYPE - 0001)

This section defines the register structure and operation of a Temperature Measurement function as it applies to the LM32. The FuncDescriptor value of this function is '0001'.

2.9.1 Operation

The Temperature Measurement function as implemented in the LM32 supports 3 temperature zones, the LM32's internal temperature (LM32's junction temperature) and the remote temperature of 2 thermal diodes (stand alone transistors or integrated in chips). The function measures multiple temperature points and reports the readout to the master. The measurement of all the enabled temperature sensors is cyclic and continuous.

Sensor Scan The Control register of the function defines which temperature sensors are included in the scan. A sensor is scanned only if it is enabled by the Sensor Enable bits (EN0, EN1, and EN2). The sensors are scanned in an ascending, round-robin order, based on the sensor number. Disabled sensors are skipped and the next enabled sensor in ascending order is scanned.

The minimum scan rate is recommended to be 4Hz (i.e. the measurement data is updated at least once in 250 ms), see *Section 2.10* for further details. In Low-Power Mode, the scan rate is four times lower than the scan rate in Active Mode. The scan rate effects the bus bandwidth required to read the results. The sampling rate of the temperature measurements can also be controlled via the Conversion Rate register, see *Section 2.10* for further details.

Data Readout When a new result is stored in the Readout register a Function Event is generated. Reading the Readout register clears the Status Function 1 flag (SF1). The result is available in the Readout register waiting for the master to read it during the master sensor read sequence. If a new result is ready before the previous result has been read, the new result overwrites the previous result and the Error Function 1 flag (ERF1) is set (indicating an overrun event). Reading the Readout

2.0 Register Set (Continued)

register clears also the Error Function 1 flag (ERF1). The Readout register contains the temperature data, and the sensor number. Since the LM32 only supports three temperature zones the sensor number field will be zero to two. Other fields in the Readout register as defined by the SensorPath specification are not supported.

Readout Resolution The resolution of the readout is defined in the Temperature Capabilities register. The resolution of the LM32 is fixed and cannot be modified by software. The temperature readout type is common to all the sensors and is signed two's complement fixed point value. The readout type is specified in the Capabilities register of the function.

Sensor 0 in the Temperature Measurement function is reserved for local temperature measurement (i.e., the junction temperature of the LM32).

Function Event The Temperature Measurement function generates a Function Event whenever a conversion cycle is completed and new data is stored in the Readout Register. When the new data is stored into the Readout register the SF1 bit in the device Status register is set to "1" and remains set, until it is cleared by reading the Readout register. An Attention Request is generated on the bus, only if it is enabled by the Attention Enable bit (ATE) in the Temperature Control register.

Setup Before Enabling No setup is required for the Temperature Measurement function before the function is enabled.

2.9.2 Temperature Capabilities (Addr: 001 000; 08h)

Reg Add	Register Name	R/W	POR Val	Bit 15 MSb	Bit 14	Bit 13	Bit 12	Bit 11	Bit 10	Bit 9	Bit 8	Bit 7	Bit 6	Bit 5	Bit 4	Bit 3	Bit 2	Bit 1	Bit 0 LSB
001 000	Temperature Capabilities	R	0549h	Reserved				# of Remotes			Int Sens	Rout Size	Sign	10-Bits			0.5°C Resolution		
				0	0	0	0	0	1	0	1	0	1	0	0	1	0	0	1

This register defines the format of the temperature data in the readout register. The LM32 only supports one format for all temperatures as defined by the values of this register.

Bit	Type	Description
2-0	RO	Resolution. This field defines the value of 1 LSB of the Temperature Readout field in the Readout Register. The SensorPath specification defines many different weights for the temperature LSB. The LM32 supports a resolution of 0.5 °C and thus a value of 001 for this field. For a full definition of this field, please refer to the SensorPath specification.
5-3	RO	Number of Bits. This field defines the total number of significant bits of the Temperature Readout field in the Readout register. The total number of significant bits includes the number of bits representing the integer part of the temperature data and the fractional part of it, as defined by the Resolution field. The LM32 supports 10-bits and thus a value of 001 for this field. For a full definition of this field please refer to the SensorPath specification.
6	RO	Sign (Signed Data). Defines the type of data in the Temperature Readout field of the Readout register. 0: Unsigned, positive fixed point value. 1: Signed, 2's complement fixed point value. (value for the LM32)
7	RO	RoutSize (Readout Register size). Defines the total size of the Readout register. 0: 16 bits. (value for the LM32)
8	RO	IntSens (Internal Sensor Support). Indicates if the device supports internal temperature measurements, as the LM32 does. 0: No internal temperature measurement 1: Internal temperature sensor implemented. (value for the LM32)
11-9	RO	# of Remotes (Number of Remote Sensors). Specifies the number of remote Temperature Sensors supported by the function. 2: The number of Remote Temperature Sensors. (value for the LM32)
15-12	RO	Reserved. Will always read "0".

2.0 Register Set (Continued)

2.9.3 Temperature Data Readout (Addr: 001 001; 09h)

Reg Add	Register Name	R/W	P O R Val	Bit 15 MSb	Bit 14	Bit 13	Bit 12	Bit 11	Bit 10	Bit 9	Bit 8	Bit 7	Bit 6	Bit 5	Bit 4	Bit 3	Bit 2	Bit 1	Bit 0 LSb
001 001	Local Temperature Data Readout	R		MSb Sign	128 °C	64°C	32°C	16°C	8°C	4°C	2°C	1°C	0.5 °C	Reserved		SNUM		Reserved	
	0 0													0	0				
	Reserved													EF				Res	
	0 0																	0	

Bit	Type	Description
0	RO	Reserved. Will always read "0".
1	RO	Reserved for Local Temperature Data Readout. Will always read "0". EF (Error Flag) for Remote Temperature Data Readout. This bit indicates that an error was detected during the measurement of the current remote Temperature sensor such as a diode fault condition. When a diode fault occurs the value of the temperature reading will be 200h or -256°C. 0: No error detected. 1: Error detected.
3-2	RO	SNUM (Sensor Number). This field indicates the number of the current Temperature Sensor, to which the data in the Temperature Readout field belongs. Temperature Sensor 0 is always assigned to the local sensor of the LM32. 0: Local temperature sensor (see <i>Table Thermal Diode Input Mapping</i>) 1-2: Remote sensor 1 and 2 (see <i>Table Thermal Diode Input Mapping</i>)
5-4	RO	Reserved. Will always read "0".
15-6	RO	Temperature Readout. This field holds the result of the temperature measurement. The active size of this field for the LM32 is 10-bits, left justified. See <i>Table Temperature Data Format</i> for examples.

Thermal Diode Input Mapping

Sensor Number (SNUM)	Sensor Input	Board Connection
0	Local	none
1	Processor, D1+/D1-	CPU Thermal Diode
2	Remote, D2+/D2-	MMBT3904 Thermal Diode or GPU Thermal Diode

All LM32 temperature data has a common format. The LM32's temperature data format is two's complement and has 10-bits of resolution with the LSb having a weight of 0.5 °C. The LM32 can resolve temperature between +255.5 °C and -256 °C, inclusive. It can measure local temperatures between +85 °C and 0 °C and remote temperatures between +125 °C and 0 °C with an accuracy of ±3.0 °C.

Temperature Data Format

Temperature	Binary	Hex
+140 °C	01 0001 1000	118h
+100 °C	00 1100 1000	0C8h
+1 °C	00 0000 0010	002h
0 °C	00 0000 0000	000h
- 0.5 °C	11 1111 1111	3FFh
-1 °C	11 1111 1110	3FEh

2.0 Register Set (Continued)

Temperature Data Format (Continued)

Temperature	Binary	Hex
- 40 °C	11 1011 0000	3B0h
-255.5 °C	10 0000 0001	201h
-256 °C	10 0000 0000	200h

2.9.4 Temperature Control (Addr: 001 010; 0Ah)

This register is set to the reset value by a Device Reset.

Reg Add	Register Name	R/W	POR Val	Bit 15 MSb	Bit 14	Bit 13	Bit 12	Bit 11	Bit 10	Bit 9	Bit 8	Bit 7	Bit 6	Bit 5	Bit 4	Bit 3	Bit 2	Bit 1	Bit 0 LSB
001 010	Temperature Control	R/W	0h	Reserved												EN2	EN1	EN0	ATE
				0	0	0	0	0	0	0	0	0	0	0	0				

Bit	Type	Description
0	R/W	ATE (Attention Enable). When set, this bit enables an Attention Request signal to be generated by the LM32, if the EN0, EN1 or EN2 bits of this register are set. 0: Attention Request disabled (from enabled Temperature Sensor- default) 1: Attention Request enabled (from enabled Temperature Sensor)
1	R/W	EN0 (Enable Sensor 0). When this bit is set, the Local Temperature Sensor is enabled for temperature measurements. 0: Temperature Sensor disabled (default) 1: Temperature Sensor enabled
2	R/W	EN1 (Enable Sensor 1). When this bit is set, the Remote Thermal Diode 1 Temperature Sensor is enabled for temperature measurements. 0: Temperature Sensor disabled (default) 1: Temperature Sensor enabled
3	R/W	EN2 (Enable Sensor 2). When this bit is set, the Remote Thermal Diode 2 Temperature Sensor is enabled for temperature measurements. 0: Temperature Sensor disabled (default) 1: Temperature Sensor enabled
15-4	RO	Reserved. Will always read "0".

2.10 CONVERSION RATE (Addr: 100 000; 20h)

Reg Add	Register Name	R/W	POR Val	Bit 7	Bit 6	Bit 5	Bit 4	Bit 3	Bit 2	Bit 1	Bit 0 LSB
100 000	Conversion Rate	R/W	2h	Reserved						CR1	CR0
				0	0	0	0	0	0		

Bit	Type	Description
1-0	RO	CR0 and CR1 (Conversion Rate bits 0 and 1) These bits control the conversion rate of the LM32 for more details see <i>Table Conversion Rate Control</i> and description below.
7-2	RO	Reserved. Will always read "0".

Conversion Rate Control

LowPwr	[CR1:CR0]	Typical Conversion Rate (ms)
0	00	Fastest*: continuous
1	00	91

2.0 Register Set (Continued)

Conversion Rate Control (Continued)

LowPwr	[CR1:CR0]	Typical Conversion Rate (ms)
0	01	91
1	01	364
0	10	182 (default)
1	10	728
0	11	364
1	11	1456

*Fastest: $2 \times 7.5\text{ms}(\text{remote}) + 7.5\text{msec}(\text{local}) = 22.5\text{ ms total}$

The sensor conversion rate is controlled by this register as well as the Low Power Bit of Device Control Register. This register is not defined by the SensorPath specification. Therefore, on a motherboard when using a Super I/O host this register must be modified during BIOS run time. The conversion rate is dependent on system physical requirements and limitations. The thermal response time of the MSOP package is one such requirement. Most systems will function properly with the default settings. The master scan rate is related to the conversion rate of the LM32. If attentions are enabled the conversion rate and scan rate will be equal.

3.0 Application Hints

The LM32 can be applied easily in the same way as other integrated-circuit temperature sensors, and its remote diode sensing capability allows it to be used in new ways as well. It can be soldered to a printed circuit board, and because the path of best thermal conductivity is between the die and the pins, its temperature will effectively be that of the printed circuit board lands and traces soldered to the LM32's pins. This presumes that the ambient air temperature is almost the same as the surface temperature of the printed circuit board; if the air temperature is much higher or lower than the surface temperature, the actual temperature of the of the LM32 die will be at an intermediate temperature between the surface and air temperatures. Again, the primary thermal conduction path is through the leads, so the circuit board temperature will contribute to the die temperature much more strongly than will the air temperature.

To measure temperature external to the LM32's die, use a remote diode. This diode can be located on the die of a target IC, allowing measurement of the IC's temperature, independent of the LM32's temperature. The LM32 has been optimized to measure the remote diode of a 90 nm Pentium 4 processor as shown in *Figure 7*. A discrete diode can also be used to sense the temperature of external objects or ambient air. Remember that a discrete diode's temperature will be affected, and often dominated, by the temperature of its leads.

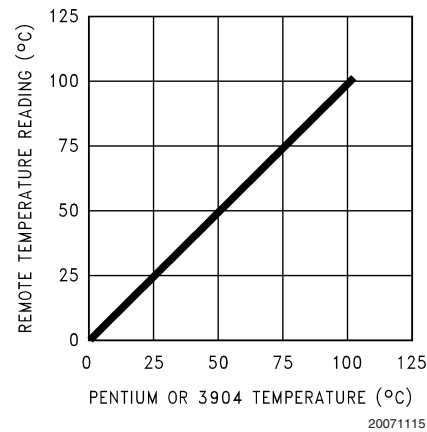

FIGURE 7. 90 nm Pentium 4 Temperature vs LM32 Temperature Reading

Most silicon diodes do not lend themselves well to this application. It is recommended that a 2N3904 transistor base emitter junction be used with the collector tied to the base.

A diode connected 2N3904 approximates the junction available on a Pentium microprocessor for temperature measurement. Therefore, the LM32 can sense the temperature of this diode effectively. Although, an offset will be observed. The temperature reading will be offset by approximately -4.5°C , therefore a correction factor of $+4.5^{\circ}\text{C}$ should be added to all temperature readings when using a 2N3904 transistor.

3.1 DIODE NON-IDEALITY

3.1.1 Diode Non-Ideality Factor Effect on Accuracy

When a transistor is connected as a diode, the following relationship holds for variables V_{BE} , T and I_f :

$$I_f = I_s \left[e^{\frac{V_{be}}{\eta V_t}} - 1 \right]$$

where:

3.0 Application Hints (Continued)

$$V_t = \frac{kT}{q}$$

- $q = 1.6 \times 10^{-19}$ Coulombs (the electron charge),
- T = Absolute Temperature in Kelvin
- $k = 1.38 \times 10^{-23}$ joules/K (Boltzmann's constant),
- η is the non-ideality factor of the process the diode is manufactured on,
- I_S = Saturation Current and is process dependent,
- I_F = Forward Current through the base emitter junction
- V_{BE} = Base Emitter Voltage drop

In the active region, the -1 term is negligible and may be eliminated, yielding the following equation

$$I_F = I_S \left[e^{\frac{V_{be}}{\eta V_t}} \right]$$

In the above equation, η and I_S are dependant upon the process that was used in the fabrication of the particular diode. By forcing two currents with a very controlled ration (N) and measuring the resulting voltage difference, it is possible to eliminate the I_S term. Solving for the forward voltage difference yields the relationship:

$$V_{be} = \eta \frac{kT}{q} \ln(N)$$

The non-ideality factor, η , is the only other parameter not accounted for and depends on the diode that is used for measurement. Since ΔV_{BE} is proportional to both η and T , the variations in η cannot be distinguished from variations in temperature. Since the non-ideality factor is not controlled by the temperature sensor, it will directly add to the inaccuracy of the sensor. For the Pentium III Intel specifies a $\pm 1\%$ variation in η from part to part. As an example, assume a temperature sensor has an accuracy specification of $\pm 3^\circ\text{C}$ at room temperature of 25°C and the process used to manufacture the diode has a non-ideality variation of $\pm 1\%$. The resulting accuracy of the temperature sensor at room temperature will be:

$$T_{ACC} = \pm 3^\circ\text{C} + (\pm 1\% \text{ of } 298^\circ\text{K}) = \pm 6^\circ\text{C}$$

The additional inaccuracy in the temperature measurement caused by η , can be eliminated if each temperature sensor is calibrated with the remote diode that it will be paired with. The following table shows the variations in non-ideality for a variety of processors.

Processor Family	η , non-ideality			Series R
	min	typ	max	
Pentium II	1	1.0065	1.0173	
Pentium III CPUID 67h	1	1.0065	1.0125	
Pentium III CPUID 68h/PGA370Socket/Celeron	1.0057	1.008	1.0125	
Pentium 4, 423 pin	0.9933	1.0045	1.0368	
Pentium 4, 478 pin	0.9933	1.0045	1.0368	

Pentium 4 on 0.13 micron process, 2-3.06GHz	1.0011	1.0021	1.0030	3.64 Ω
Pentium 4 on 90 nm process		1.011		3.33 Ω
Pentium M Processor (Centrino)	1.00151	1.00220	1.00289	3.06 Ω
MMBT3904		1.003		
AMD Athlon MP model 6	1.002	1.008	1.016	

3.2 PCB LAYOUT for MINIMIZING NOISE

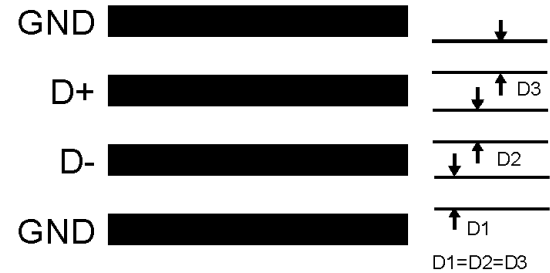

20071117

FIGURE 8. Ideal Diode Trace Layout

In a noisy environment, such as a processor mother board, layout considerations are very critical. Noise induced on traces running between the remote temperature diode sensor and the LM32 can cause temperature conversion errors. Keep in mind that the signal level the LM32 is trying to measure is in microvolts. The following guidelines should be followed:

1. Place the 100 pF and 0.1 μF power supply bypass capacitors as close as possible to the LM32's power pin. Place the recommended thermal diode 100 pF capacitor as close as possible to the LM32's D+ and D- pins. Make sure the traces to the thermal diode 100 pF capacitor are matched.
2. The recommended 100 pF diode capacitor actually has a range of 0 pF to 3.3 nF (see curve in Typical Performance Characteristics for effect on accuracy). The average temperature accuracy will not degrade. Increasing the capacitance will lower the corner frequency where differential noise error affects the temperature reading thus producing a reading that is more stable. Conversely, lowering the capacitance will increase the corner frequency where differential noise error affects the temperature reading thus producing a reading that is less stable.
3. Ideally, the LM32 should be placed within 10cm of the Processor diode pins with the traces being as straight, short and identical as possible. Trace resistance of 0.7 Ω can cause as much as 1°C of error. This error can be compensated for by adding or subtracting an offset to the remote temperature reading(s).

3.0 Application Hints (Continued)

4. Diode traces should be surrounded by a GND guard ring to either side, above and below if possible. This GND guard should not be between the D+ and D- lines. In the event that noise does couple to the diode lines it would be ideal if it is coupled common mode. That is equally to the D+ and D- lines.
5. Avoid routing diode traces in close proximity to power supply switching or filtering inductors.
6. Avoid running diode traces close to or parallel to high speed digital and bus lines. Diode traces should be kept at least 2cm apart from the high speed digital traces.
7. If it is necessary to cross high speed digital traces, the diode traces and the high speed digital traces should cross at a 90 degree angle.
8. The ideal place to connect the LM32's GND pin is as close as possible to the Processors GND associated with the sense diode.
9. Leakage current between D+ and GND should be kept to a minimum. Seventeen nano-amperes of leakage can cause as much as 0.2°C of error in the diode temperature reading (see curve in *Section Typical Performance Characteristics*). Keeping the printed circuit board as clean as possible will minimize leakage current.

The SensorPath Bus is less sensitive to noise than its predecessor the SMBus due to the inherent filtering present in the pulse-width encoding of the data. Care still needs to be taken such that induced noise is analyzed and minimized. SensorPath Bus corrupt data is the most common symptom for noise coupled in SWD. A no-ACK is the symptom for noise coupled into the Device Number Select pin (ADD). An RC lowpass filter as well as a debouncing circuit are included in the LM32 that filter noise spikes less than 2.5 µsec in duration on the SWD signal.

Physical Dimensions inches (millimeters)

unless otherwise noted

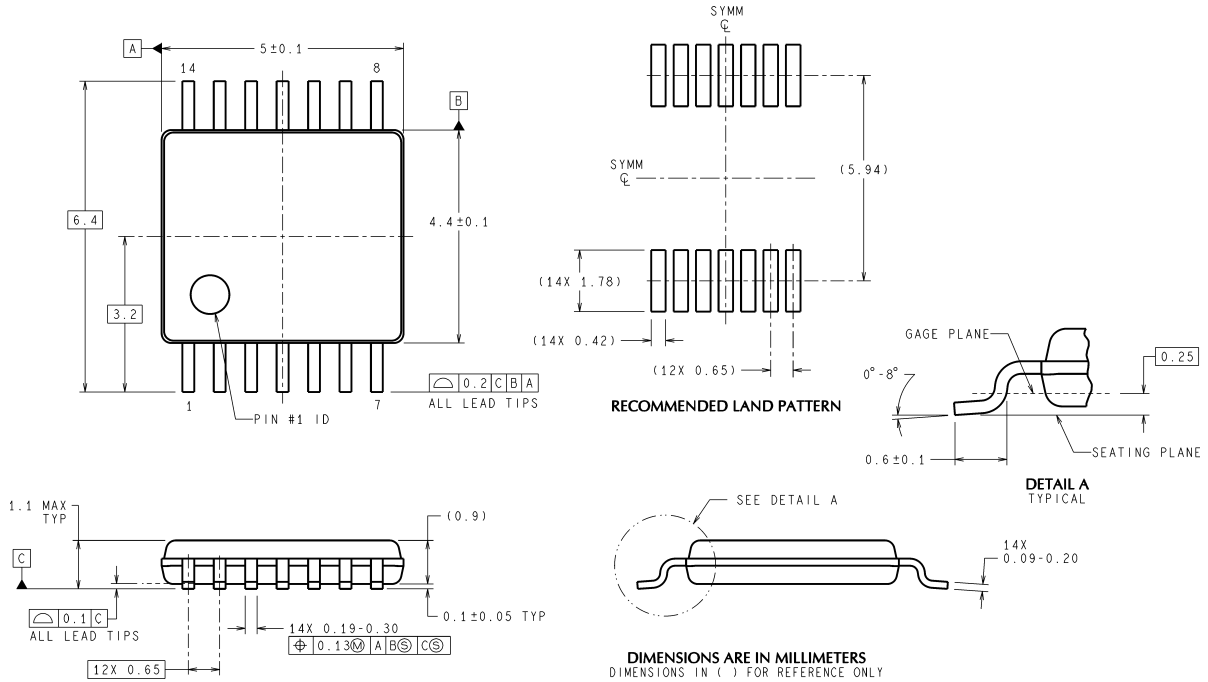

MTC14 (Rev D)

**14-Lead Molded Thin Shrink Small Outline Package (TSSOP,
JEDEC Registration Number MO-153 Variation AB Ref Note 6 dated 7/93,
Order Number LM32CIMT, or LM32CIMTX,
NS Package Number MTC14C**

LIFE SUPPORT POLICY

NATIONAL'S PRODUCTS ARE NOT AUTHORIZED FOR USE AS CRITICAL COMPONENTS IN LIFE SUPPORT DEVICES OR SYSTEMS WITHOUT THE EXPRESS WRITTEN APPROVAL OF THE PRESIDENT AND GENERAL COUNSEL OF NATIONAL SEMICONDUCTOR CORPORATION. As used herein:

1. Life support devices or systems are devices or systems which, (a) are intended for surgical implant into the body, or (b) support or sustain life, and whose failure to perform when properly used in accordance with instructions for use provided in the labeling, can be reasonably expected to result in a significant injury to the user.
2. A critical component is any component of a life support device or system whose failure to perform can be reasonably expected to cause the failure of the life support device or system, or to affect its safety or effectiveness.

BANNED SUBSTANCE COMPLIANCE

National Semiconductor certifies that the products and packing materials meet the provisions of the Customer Products Stewardship Specification (CSP-9-111C2) and the Banned Substances and Materials of Interest Specification (CSP-9-111S2) and contain no "Banned Substances" as defined in CSP-9-111S2.



National Semiconductor
Americas Customer
Support Center
Email: new.feedback@nsc.com
Tel: 1-800-272-9959

National Semiconductor
Europe Customer Support Center
Fax: +49 (0) 180-530 85 86
Email: europa.support@nsc.com
Deutsch Tel: +49 (0) 69 9508 6208
English Tel: +44 (0) 870 24 0 2171
Français Tel: +33 (0) 1 41 91 8790

National Semiconductor
Asia Pacific Customer
Support Center
Email: ap.support@nsc.com

National Semiconductor
Japan Customer Support Center
Fax: 81-3-5639-7507
Email: jpn.feedback@nsc.com
Tel: 81-3-5639-7560

www.national.com

National does not assume any responsibility for use of any circuitry described, no circuit patent licenses are implied and National reserves the right at any time without notice to change said circuitry and specifications.