

LM2702

TFT Panel Module

General Description

The LM2702 is a compact bias solution for TFT displays. It has a current mode PWM step-up DC/DC converter with a 2A, 0.2Ω internal switch. Capable of generating 8V at 170mA from a Lithium Ion battery, the LM2702 is ideal for generating bias voltages for large screen LCD panels. The LM2702 operates at a switching frequency of 600kHz allowing for easy filtering and low noise. An external compensation pin gives the user flexibility in setting frequency compensation, which makes possible the use of small, low ESR ceramic capacitors at the output. The LM2702 uses a patented internal circuitry to limit startup inrush current of the boost switching regulator without the use of an external softstart capacitor. An external softstart pin enables the user to tailor the softstart to a specific application. The LM2702 has an internal controllable PMOS switch used for controlling the row driver voltages. The switch can be controlled externally with a control pin and delay time. The LM2702 contains a Vcom amplifier and a Gamma buffer capable of supplying 50mA source and sink. The TSSOP-16 package ensures a low profile overall solution.

Features

- 2A, 0.2Ω, internal power switch
- V_{IN} operating range: 2.2V to 12V
- 600kHz switching frequency step-up DC/DC converter
- Inrush current limiting circuitry
- External softstart override
- Internal 7.3Ω PMOS switch
- PMOS switch control pin
- PMOS switch delay pin
- Vcom amplifier
- Gamma buffer
- 16 pin TSSOP package

Applications

- LCD Bias Supplies

Typical Application Circuit

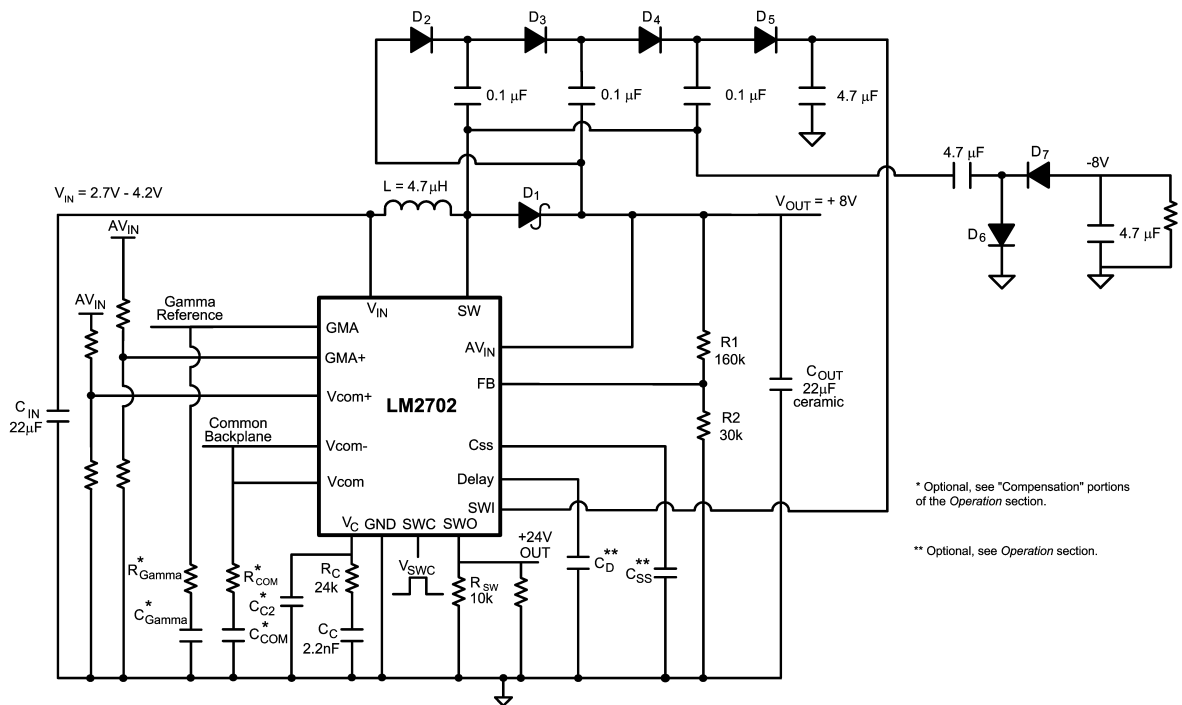

20051131

Connection Diagram

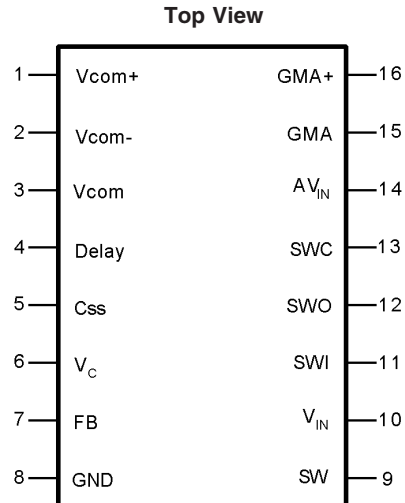

20051104

TSSOP 16 package
 $T_{JMAX} = 125^{\circ}\text{C}$, $\theta_{JA} = 120^{\circ}\text{C/W}$ (Note 1)

Pin Descriptions

Pin	Name	Function
1	Vcom+	Vcom Amplifier positive input.
2	Vcom-	Vcom Amplifier negative input.
3	Vcom	Vcom Amplifier output.
4	Delay	Switch delay.
5	Css	Soft start pin.
6	V _C	Boost Compensation Network Connection.
7	FB	Output Voltage Feedback input.
8	GND	Ground.
9	SW	NMOS power switch input.
10	V _{IN}	Main power input, step-up and switch circuitry.
11	SWI	PMOS switch input.
12	SWO	PMOS switch output.
13	SWC	PMOS switch control pin.
14	AV _{IN}	Analog power input (buffers).
15	GMA	Gamma buffer output.
16	GMA+	Gamma buffer input.

Pin Functions

Vcom+(Pin 1): Positive input terminal of Vcom amplifier.

Vcom–(Pin 2): Negative input terminal of Vcom amplifier.

Vcom(Pin 3): Output terminal of Vcom amplifier.

Delay(Pin 4): PMOS switch delay control pin. See *Operation* section for setting the delay time.

The delay time begins when the output voltage of the DC/DC switching regulator reaches 85% of its true output voltage. This corresponds to a FB voltage of about 1.1V. The PMOS switch is controlled with both the delay time and the switch control pin, SWC. If no Cdelay capacitor is used, the PMOS switch is controlled solely with the SWC pin.

Css(Pin 5): Softstart pin. Connect capacitor to Css pin and AGND plane to slowly ramp inductor current on startup. See *Operation* section for setting the softstart time.

Vc(Pin 6): Compensation Network for Boost switching regulator. Connect resistor/capacitor network between Vc pin and AGND for boost switching regulator AC compensation.

FB(Pin 7): Feedback pin. Set the output voltage by selecting values of R1 and R2 using:

$$R1 = R2 \left(\frac{V_{OUT}}{1.265V} - 1 \right)$$

Connect the ground of the feedback network to the AGND plane, which should be tied directly to the GND pin.

GND(Pin 8): Ground connect for LM2702. Connect all sensitive circuitry, ie. feedback resistors, softstart capacitor, de-

lay capacitor, and compensation network to a dedicated AGND plane which connects directly to this pin. Connect all power ground components to a PGND plane which should also connect directly to this pin. Please see Layout Considerations under the Operation section for more details on layout suggestions.

SW(Pin 9): This is the drain of the internal NMOS power switch. Minimize the metal trace area connected to this pin to minimize EMI.

VIN(Pin 10): Input Supply Pin. Bypass this pin with a capacitor as close to the device as possible. The capacitor should connect between VIN and GND.

SWI(Pin 11): PMOS switch input. Source connection of PMOS device.

SWO(Pin 12): PMOS switch output. Drain connection of PMOS device.

SWC(Pin13): PMOS switch control pin. This pin creates an AND function with the delay time after the output of the switching regulator has reached 85% of its nominal value. To ensure the PMOS switch is in the correct state, apply a voltage above 1.5V to this pin to turn on the PMOS switch and apply a voltage below 0.7V to turn off the PMOS switch.

AVIN(Pin 14): Supply pin for the Vcom opamp and the Gamma buffer. Bypass this pin with a capacitor as close to the device as possible, about 100nF. The capacitor should connect between AVIN and PGND.

GMA(Pin 15): Gamma Buffer output pin.

GMA+(Pin 16): Gamma Buffer input pin.

Ordering Information

Order Number	Package Type	NSC Package Drawing	Supplied As
LM2702MT-ADJ	TSSOP-16	MTC16	73 Units, Rail
LM2702MTX-ADJ	TSSOP-16	MTC16	2500 Units, Tape and Reel

Block Diagrams

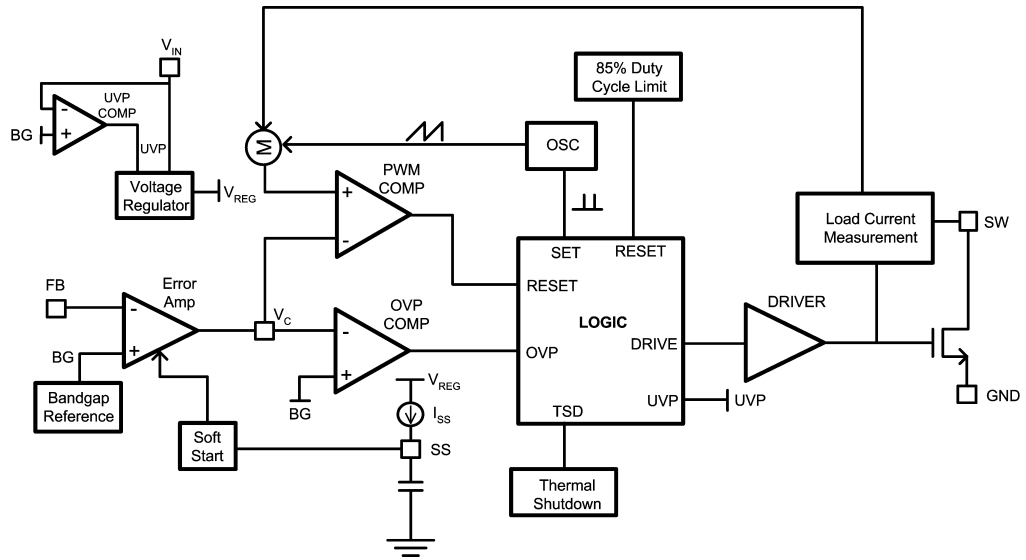

20051103

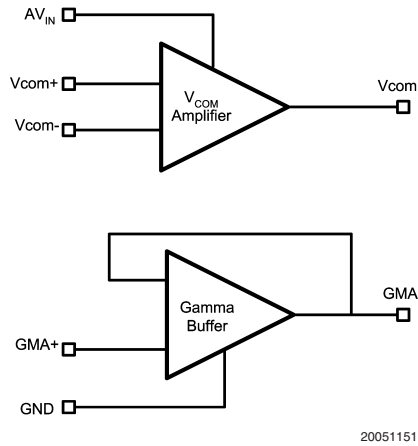

20051151

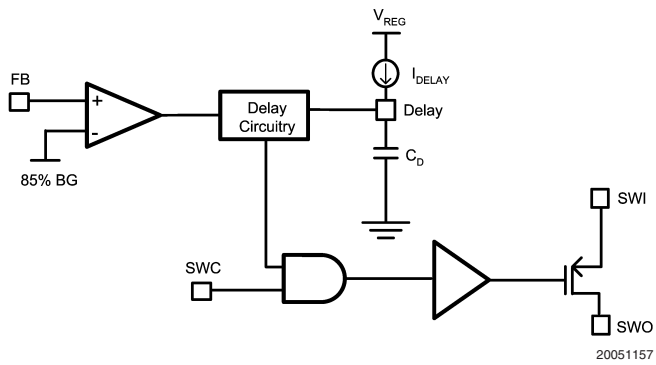

20051157

Absolute Maximum Ratings (Note 2)

If Military/Aerospace specified devices are required, please contact the National Semiconductor Sales Office/Distributors for availability and specifications.

V_{IN}	-0.3V to 12V
SW Voltage	-0.3V to 18V
FB Voltage	-0.3V to 7V
V_C Voltage	0.96V to 1.56V
CSS Voltage	-0.3V to 1.2V
SWC Voltage	-0.3V to 12V
Supply Voltage, AV_{IN}	-0.3V to 12V
Amplifier/Buffer Input/Output Voltage	Rail-to-Rail
Delay	GND to 1.3V
SWI	-0.3V to 30V

SWO

-0.3V to 30V

ESD Ratings
(Notes 3, 4)

Human Body Model	2kV
Machine Model	200V

Operating Conditions

Operating Temperature	-40°C to +125°C
Storage Temperature	-65°C to +150°C
Supply Voltage, V_{IN}	2.2V to 12V
SW Voltage	17.5V
Supply AV_{IN}	4V to 12V
SWI	2.2V to 30V

Electrical Characteristics Switching Regulator

Specifications in standard type face are for $T_J = 25^\circ\text{C}$ and those with **boldface type** apply over the full **Operating Temperature Range** ($T_J = -40^\circ\text{C}$ to $+125^\circ\text{C}$). Unless otherwise specified, $V_{IN} = 2.2\text{V}$ and $AV_{IN} = 8\text{V}$, $R_{COM} = R_{GAMMA} = 50\Omega$, $C_{COM} = C_{GAMMA} = 1\text{nF}$.

Switching Regulator

Symbol	Parameter	Conditions	Min (Note 5)	Typ (Note 6)	Max (Note 5)	Units
I_Q	Quiescent Current	Not Switching, FB = 2V		1.6	2.3	mA
		Switching, switch open, FB = 0.1V		2.6	5.2	
V_{FB}	Feedback Voltage		1.239	1.265	1.291	V
$\%V_{FB}/\Delta V_{IN}$	Feedback Voltage Line Regulation			0.01	0.1	%/V
I_{CL}	Switch Current Limit (Note 7)	$V_{IN} = 2.7\text{V}$	1.4	2	2.6	A
R_{DSON}	Switch R_{DSON} (Note 8)	$V_{IN} = 2.7\text{V}$		200		m Ω
I_B	FB Pin Bias Current (Note 9)			60	500	nA
V_{IN}	Input Voltage Range		2.2		12	V
I_{SS}	Soft Start Current		5	12	15	μA
T_{SS}	Internal Soft Start Ramp Time			7	10	mS
g_m	Error Amp Transconductance	$\Delta I = 5\mu\text{A}$	40	135	290	μmho
A_V	Error Amp Voltage Gain			135		V/V
D_{MAX}	Maximum Duty Cycle		78	85		%
f_S	Switching Frequency		480	600	720	kHz
I_L	Switch Leakage Current	$V_{SW} = 18\text{V}$		0.1	20	μA
UVP	On Threshold		1.79	1.92	2.05	V
	Off Threshold		1.69	1.82	1.95	V
	Hysteresis			100		mV

Electrical Characteristics Vcom Amplifier

Specifications in standard type face are for $T_J = 25^\circ\text{C}$ and those with **boldface type** apply over the full **Operating Temperature Range** ($T_J = -40^\circ\text{C}$ to $+125^\circ\text{C}$). Unless otherwise specified, $V_{IN} = 2.2\text{V}$ and $AV_{IN} = 8\text{V}$, $R_{COM} = R_{GAMMA} = 50\Omega$, $C_{COM} = C_{GAMMA} = 1\text{nF}$.

Vcom Amplifier

Symbol	Parameter	Conditions	Min (Note 5)	Typ (Note 6)	Max (Note 5)	Units
V_{OS}	Input Offset Voltage (Note 10)	$V_{CM} = 1\text{V}$		3.5	10	mV
		$V_{CM} = 7.5\text{V}$		3	10	
I_B	Input Bias Current	$V_{CM} = 1\text{V}$		65	200	nA
		$V_{CM} = 7.5\text{V}$		190	300	
I_{OS}	Input Offset Current	$V_{CM} = 1\text{V}$		45	130	nA
		$V_{CM} = 7.5\text{V}$		5	110	
CMVR	Input Common-mode Voltage Range		0		8	V
V_{OUT} Swing		$R_L=10\text{k}$, V_o min.		0.003	.02	V
		$R_L=10\text{k}$, V_o max.	7.94	7.98		
		$R_L=2\text{k}$, V_o min.		0.003	.02	
		$R_L=2\text{k}$, V_o max.	7.9	7.95		
A_{VOL}	Large Signal Voltage Gain	No Load, $V_o = 2\text{V}$ to 7V	74.8	87.6		dB
		$R_L=10\text{ k}\Omega$, $V_o = 2\text{V}$ to 7V	66.8	75.1		
		$R_L=2\text{ k}\Omega$, $V_o = 2\text{V}$ to 7V		55.8		
AV_{IN}	Supply Voltage		4		12	V
CMRR	Common Mode Rejection Ratio	V_{CM} stepped from 0V to 1.1V	72	91.7		dB
		V_{CM} stepped from 3V to 8V	80	105		
		V_{CM} stepped from 0V to 8V	57	80.7		
PSRR	Power Supply Rejection Ratio	$V_{CM} = 0.5\text{V}$, $AV_{IN} = 4$ to 12V	70	77		dB
I_{S+}	Supply Current (Amplifier + Buffer)	$V_o = AV_{IN}/2$, No Load		2.2	4	mA
I_{SC}	Output Short Circuit Current	Source	40	50	70	mA
		Sink	40	50	60	

Electrical Characteristics Gamma Buffer

Specifications in standard type face are for $T_J = 25^\circ\text{C}$ and those with **boldface type** apply over the full **Operating Temperature Range** ($T_J = -40^\circ\text{C}$ to $+125^\circ\text{C}$). Unless otherwise specified, $V_{IN} = 2.2\text{V}$ and $AV_{IN} = 8\text{V}$, $R_{COM} = R_{GAMMA} = 50\Omega$, $C_{COM} = C_{GAMMA} = 1\text{nF}$.

Gamma Buffer

Symbol	Parameter	Conditions	Min (Note 5)	Typ (Note 6)	Max (Note 5)	Units
V_{OS}	Input Offset Voltage (Note 10)			1	10	mV
I_B	Input Bias Current			170	300	nA
V_{GR}	Gamma Input Voltage Range		0		8	V
V_{OUT} Swing		$R_L=10\text{k}$, V_o min.		0.05	0.075	V
		$R_L=10\text{k}$, V_o max.	7.9	7.94		
		$R_L=2\text{k}$, V_o min.		0.05	0.075	
		$R_L=2\text{k}$, V_o max.	7.865	7.9		
A_{VCL}	Voltage Gain	No Load, $V_o = 2\text{V}$ to 7V	0.995	0.999		V/V
		$R_L=10\text{ k}\Omega$, $V_o = 2\text{V}$ to 7V	0.995	0.999		
		$R_L=2\text{ k}\Omega$, $V_o = 2\text{V}$ to 7V	0.993	0.998		
PSRR	Power Supply Rejection Ratio	$AV_{IN} = 4$ to 12V	70	77		dB

Electrical Characteristics Gamma Buffer (Continued)

Specifications in standard type face are for $T_J = 25^\circ\text{C}$ and those with **boldface type** apply over the full **Operating Temperature Range** ($T_J = -40^\circ\text{C}$ to $+125^\circ\text{C}$). Unless otherwise specified, $V_{IN} = 2.2\text{V}$ and $AV_{IN} = 8\text{V}$, $R_{COM} = R_{GAMMA} = 50\Omega$, $C_{COM} = C_{GAMMA} = 1\text{nF}$.

Gamma Buffer

Symbol	Parameter	Conditions	Min (Note 5)	Typ (Note 6)	Max (Note 5)	Units
AV_{IN}	Supply Voltage		4		12	V
I_{S+}	Supply Current (Amplifier + Buffer)	$V_o = AV_{IN}/2$, No Load		2.2	4	mA
I_{SC}	Output Short Circuit Current	Source	50	66	75	mA
		Sink	40	56	65	

Electrical Characteristics PMOS Switch Logic Control

Specifications in standard type face are for $T_J = 25^\circ\text{C}$ and those with **boldface type** apply over the full **Operating Temperature Range** ($T_J = -40^\circ\text{C}$ to $+125^\circ\text{C}$). Unless otherwise specified, $V_{IN} = 2.2\text{V}$ and $AV_{IN} = 8\text{V}$, $R_{COM} = R_{GAMMA} = 50\Omega$, $C_{COM} = C_{GAMMA} = 1\text{nF}$.

PMOS Switch Logic Control

Symbol	Parameter	Conditions	Min (Note 5)	Typ (Note 6)	Max (Note 5)	Units
I_{DELAY}	Delay Current		4.7	5.7	6.4	μA
R_{DSON}	PMOS Switch ON Resistance			7.3	20	Ω
I_{SWO}	PMOS Switch Current	Switch ON		20		mA
I_{SWI}	PMOS Switch Input Current	SWC = 0V, SWO Open, SWI = 30V		32		μA
		SWC = 1.7V, SWO Open, SWI = 30V		118		
V_{SWC}	Switch ON		1.5	1.1		V
	Switch OFF			1.1	0.7	

Note 1: The maximum allowable power dissipation is a function of the maximum junction temperature, $T_J(\text{MAX})$, the junction-to-ambient thermal resistance, θ_{JA} , and the ambient temperature, T_A . See the Electrical Characteristics table for the thermal resistance of various layouts. The maximum allowable power dissipation at any ambient temperature is calculated using: $P_D(\text{MAX}) = (T_J(\text{MAX}) - T_A)/\theta_{JA}$. Exceeding the maximum allowable power dissipation will cause excessive die temperature, and the regulator will go into thermal shutdown.

Note 2: Absolute maximum ratings are limits beyond which damage to the device may occur. Operating Ratings are conditions for which the device is intended to be functional, but device parameter specifications may not be guaranteed. For guaranteed specifications and test conditions, see the Electrical Characteristics.

Note 3: The human body model is a 100 pF capacitor discharged through a 1.5k Ω resistor into each pin. The machine model is a 200pF capacitor discharged directly into each pin.

Note 4: Vcom pin is rated for 1.5kV Human Body Model and 150V Machine Model.

Note 5: All limits guaranteed at room temperature (standard typeface) and at temperature extremes (bold typeface). All room temperature limits are 100% production tested or guaranteed through statistical analysis. All limits at temperature extremes are guaranteed via correlation using standard Statistical Quality Control (SQC) methods. All limits are used to calculate Average Outgoing Quality Level (AOQL).

Note 6: Typical numbers are at 25°C and represent the most likely norm.

Note 7: Duty cycle affects current limit due to ramp generator. Current limit is at 0% duty cycle and will decrease with higher duty cycles. See *Typical Performance Characteristics* for a graph of Power Switch Current Limit vs. V_{IN} and Power Switch Current Limit vs. Temp.

Note 8: See the graph titled " R_{DSON} vs. V_{IN} " for a more accurate value of the power switch R_{DSON} .

Note 9: Bias current flows into FB pin.

Note 10: Refer to the graphs titled "Input Offset Voltage vs. Common Mode Voltage".

Typical Performance Characteristics

Efficiency vs. Load Current
($V_{OUT} = 8V$)

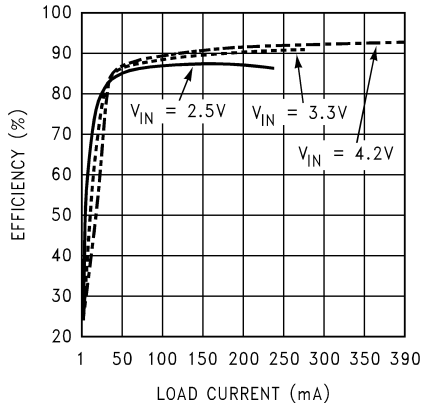

20051126

Efficiency vs. Load Current
($V_{OUT} = 10V$)

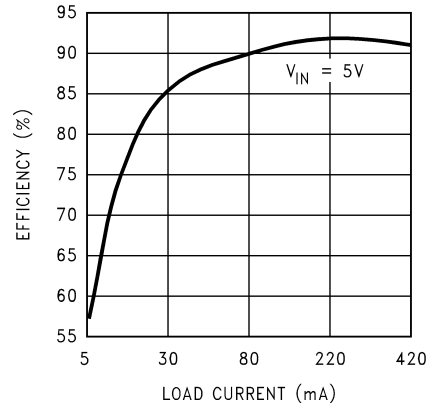

20051173

Frequency vs. V_{IN}

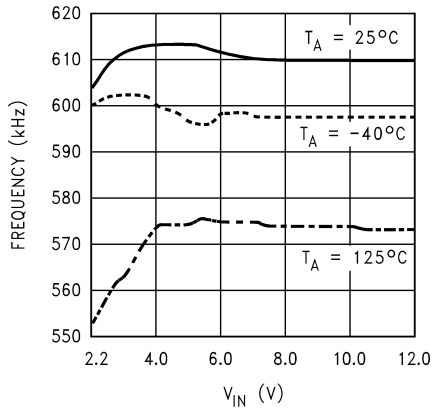

20051125

Power Switch Current Limit vs. Temperature
($V_{OUT} = 8V$)

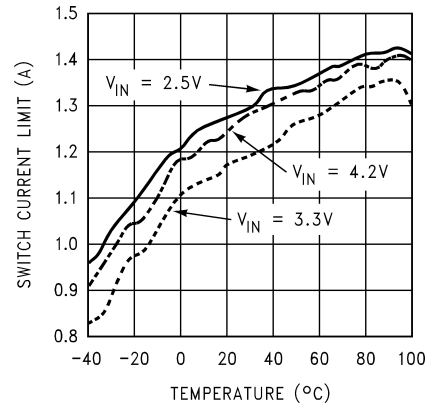

20051120

Power Switch Current Limit vs. V_{IN}

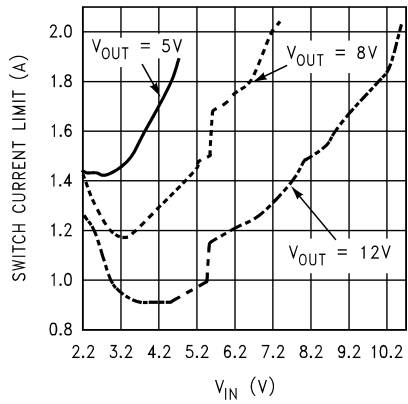

20051122

$R_{DS(ON)}$ vs. V_{IN}
($I_{SW} = 1A$)

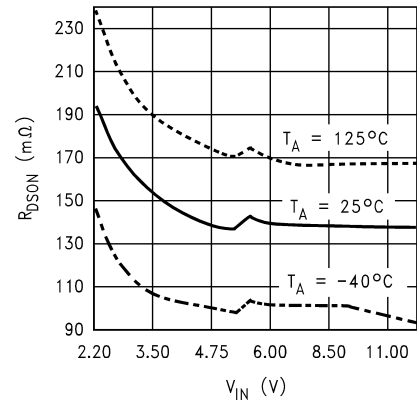

20051127

Typical Performance Characteristics (Continued)

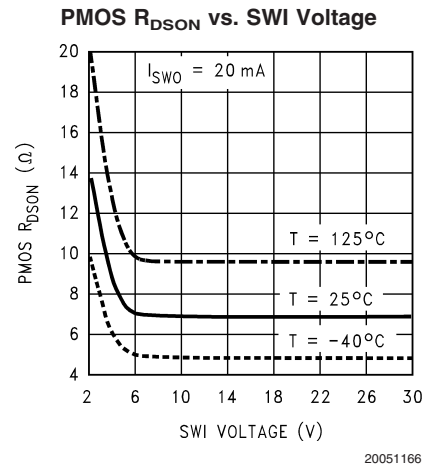
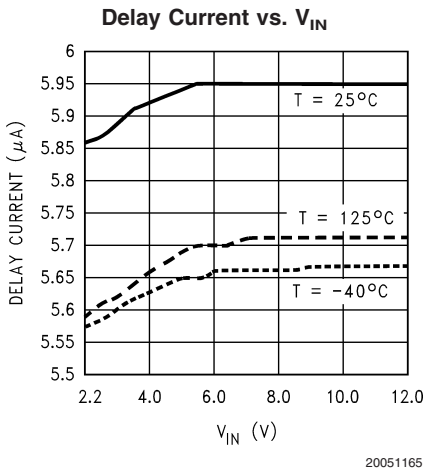
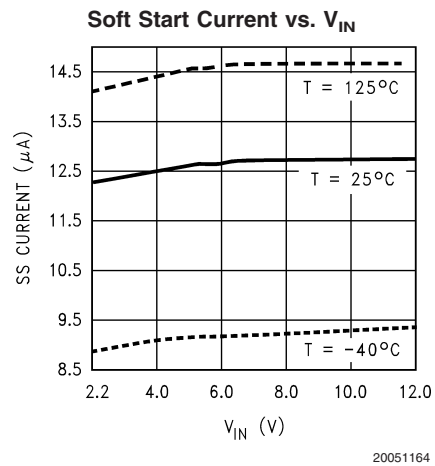
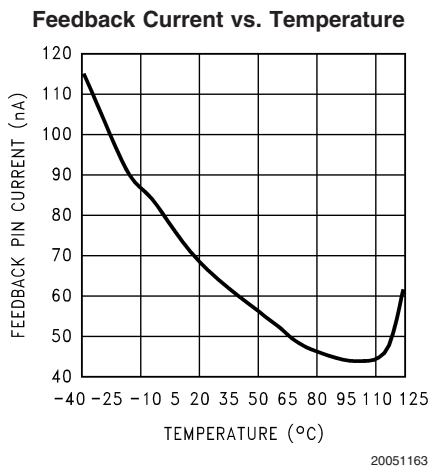
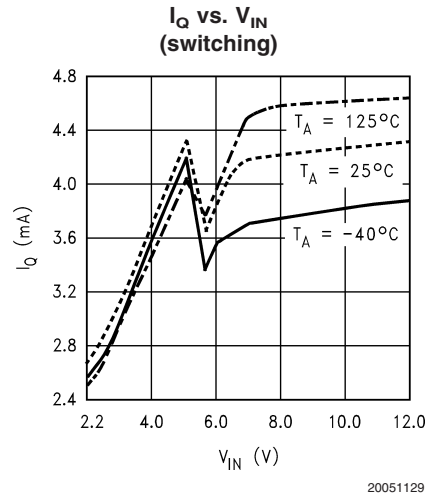
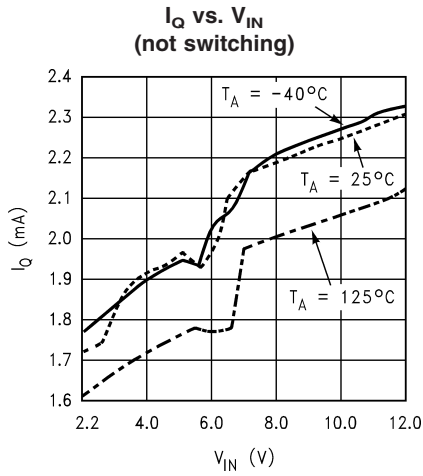

Typical Performance Characteristics (Continued)

SWI Current vs. SWI Voltage (PMOS ON)

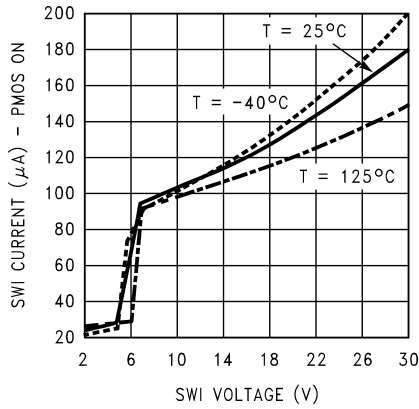

20051167

SWI Current vs. SWI Voltage (PMOS OFF)

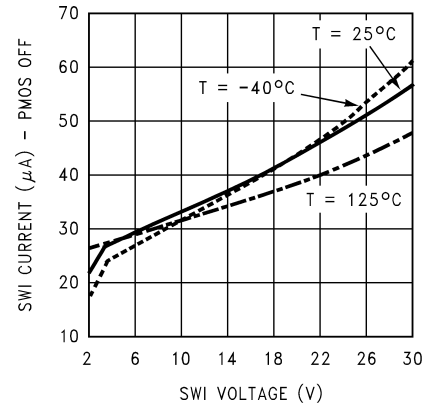

20051168

Load Transient Response

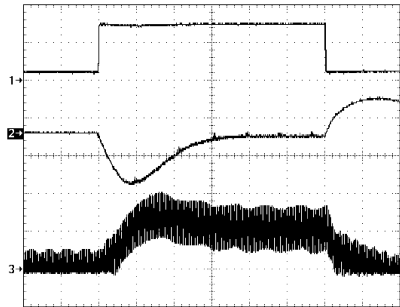

20051116

$V_{OUT} = 8V$, $V_{IN} = 2.5V$

- 1) Load, 20mA to 155mA to 20mA, DC
 - 2) V_{OUT} , 200mV/div, AC
 - 3) I_L , 500mA/div, DC
- T = 50µs/div

PMOS Switching Waveform

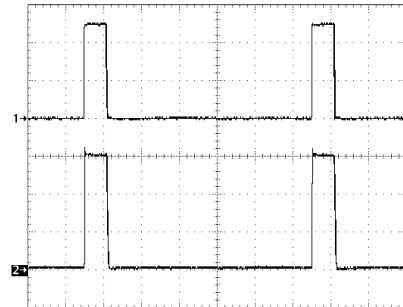

20051158

$V_{OUT} = 8V$, $V_{IN} = 2.5V$, $R_{LOAD} = 40\Omega$, $C_{SS} = \text{none}$

- $C_D = 100nF$, $R_{SW} = 10k||1.5k$, SWI = 30V, 10% duty cycle
 - 1) SWC, 1V/div, DC
 - 2) SWO, 10V/div, DC
- T = 2.5µs/div

PMOS Rising Edge

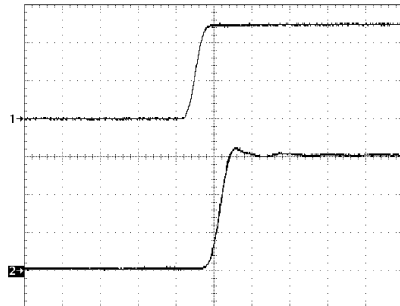

20051159

$V_{OUT} = 8V$, $V_{IN} = 2.5V$, $R_{LOAD} = 40\Omega$, $C_{SS} = \text{none}$

- $C_D = 100nF$, $R_{SW} = 10k||1.5k$, SWI = 30V
 - 1) SWC, 1V/div, DC
 - 2) SWO, 10V/div, DC
- T = 50ns/div

PMOS Falling Edge

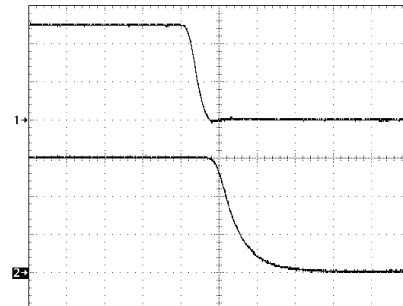

20051160

$V_{OUT} = 8V$, $V_{IN} = 2.5V$, $R_{LOAD} = 40\Omega$, $C_{SS} = \text{none}$

- $C_D = 100nF$, $R_{SW} = 10k||1.5k$, SWI = 30V
 - 1) SWC, 1V/div, DC
 - 2) SWO, 10V/div, DC
- T = 50ns/div

Typical Performance Characteristics (Continued)

Internal Soft Start and PMOS Delay

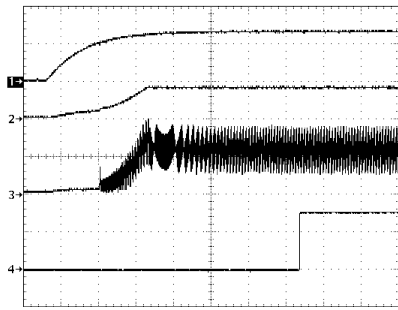

20051161

$V_{OUT} = 8V$, $V_{IN} = 2.5V$, $R_{LOAD} = 40\Omega$, $C_{SS} = \text{none}$
 $C_D = 100nF$, $R_{SW} = 10k|1.5k$, $SWI = 30V$, $SWC = V_{IN}$
 1) V_{IN} , 2V/div, DC
 2) V_{OUT} , 10V/div, DC
 3) I_L , 500mA/div, DC
 4) SWO , 20V/div, DC
 T = 5ms/div

External Soft Start and PMOS Delay

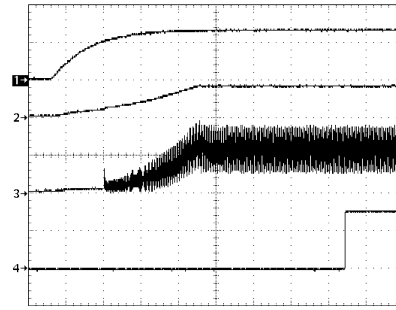

20051162

$V_{OUT} = 8V$, $V_{IN} = 2.5V$, $R_{LOAD} = 40\Omega$, $C_{SS} = 330nF$
 $C_D = 100nF$, $R_{SW} = 10k|1.5k$, $SWI = 30V$, $SWC = V_{IN}$
 1) V_{IN} , 2V/div, DC
 2) V_{OUT} , 10V/div, DC
 3) I_L , 500mA/div, DC
 4) SWO , 20V/div, DC
 T = 5ms/div

Input Offset Voltage vs. Common Mode Voltage (Vcom, 3 units)

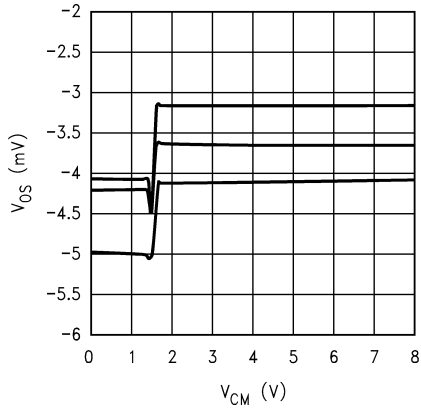

20051174

Input Offset Voltage vs. Common Mode Voltage (Vcom Over Temperature)

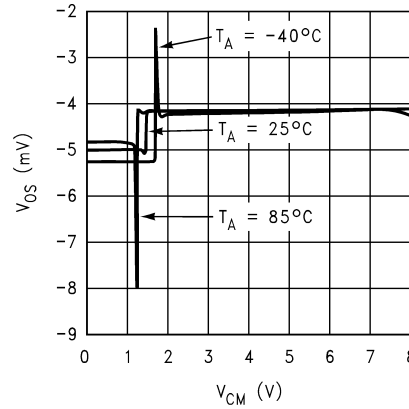

20051175

Input Offset Voltage vs. Common Mode Voltage (Gamma, 3 units)

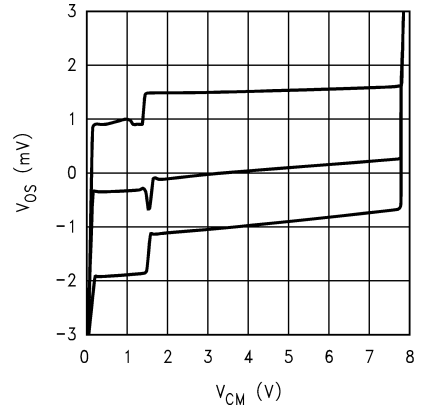

20051176

Input Offset Voltage vs. Common Mode Voltage (Gamma Over Temperature)

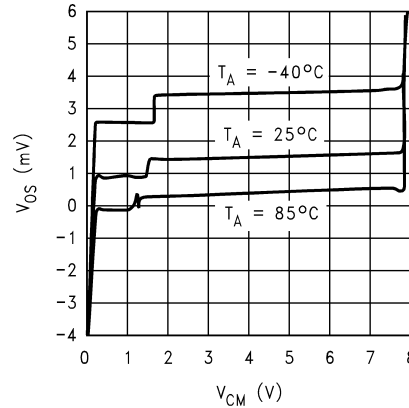

20051177

Typical Performance Characteristics (Continued)

Input Bias Current vs. Common Mode Voltage (Vcom)

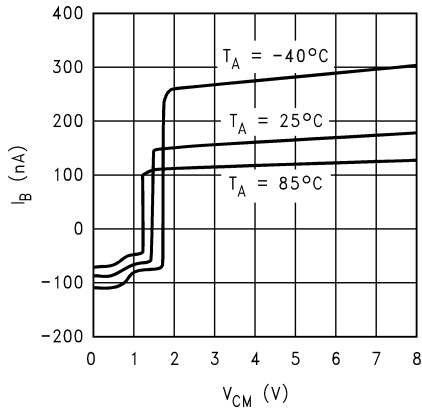

20051178

Input Bias Current vs. Common Mode Voltage (Gamma)

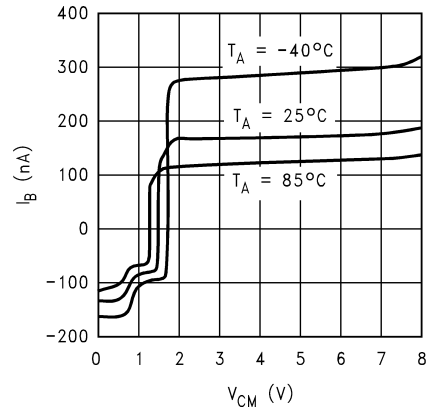

20051179

Output Voltage vs. Output Current (Vcom or Gamma, sinking)

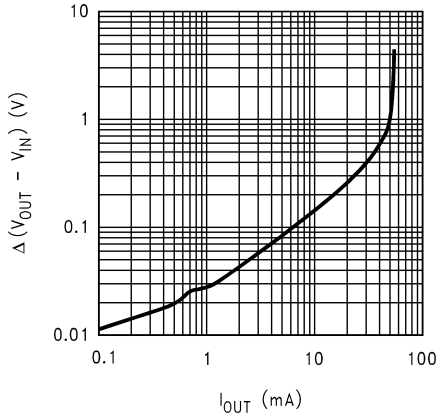

20051180

Output Voltage vs. Output Current (Vcom or Gamma, sourcing)

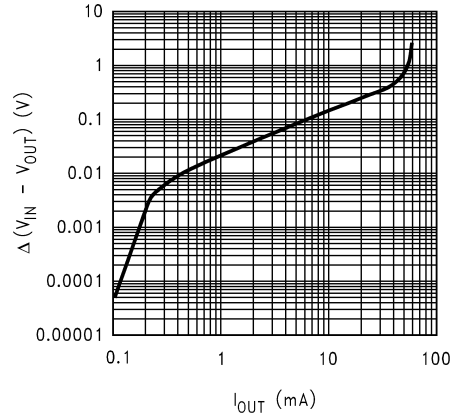

20051181

Supply Current vs. Common Mode Voltage (Both Amplifiers)

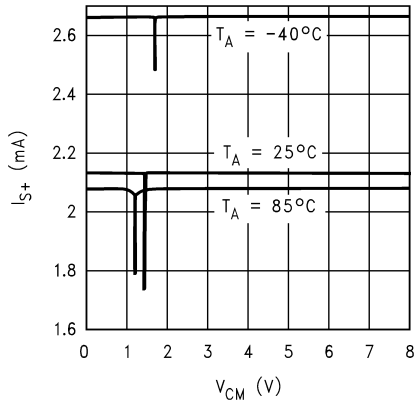

20051182

Large Signal Step Response (50Ω, 1nF ext. compensation)

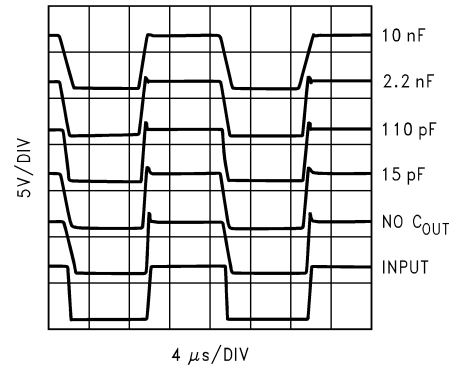

20051183

Typical Performance Characteristics (Continued)

Large Signal Step Response
(no ext. compensation)

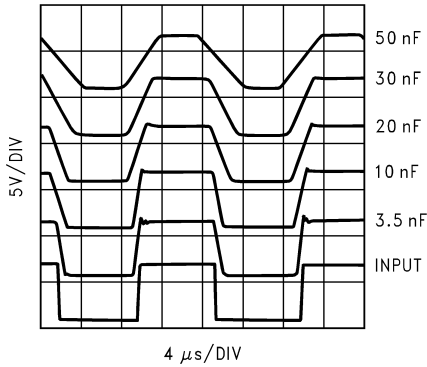

20051184

Positive Slew Rate vs. Capacitive Load
(Vcom or Gamma)

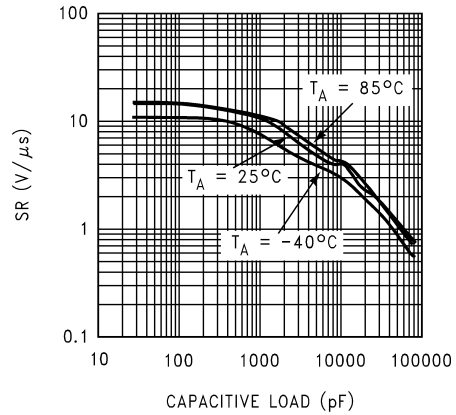

20051190

Negative Slew Rate vs. Capacitive Load
(Vcom or Gamma)

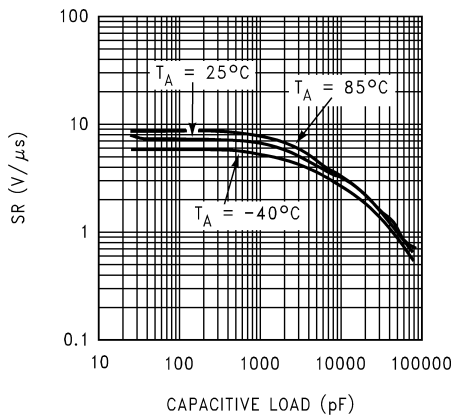

20051185

Phase Margin vs. Capacitive Load
(Vcom)

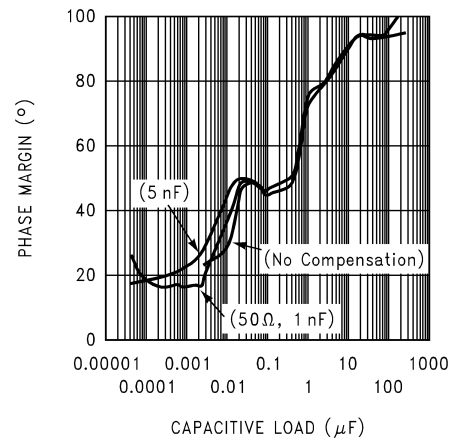

20051186

Unity Gain Frequency vs. Capacitive Load
(Vcom)

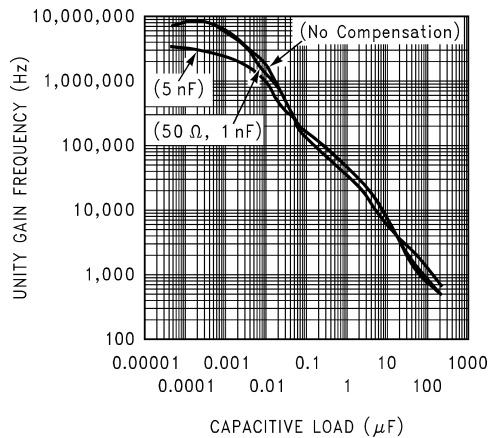

20051187

CMRR vs. Frequency
(Vcom)

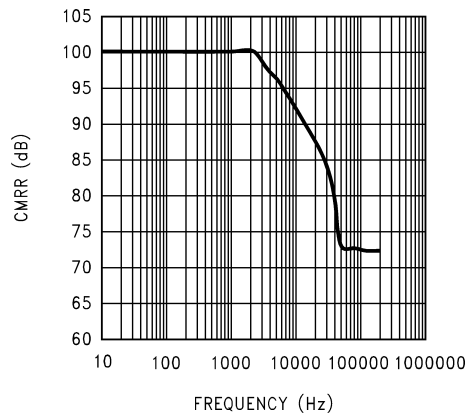

20051188

Typical Performance Characteristics (Continued)

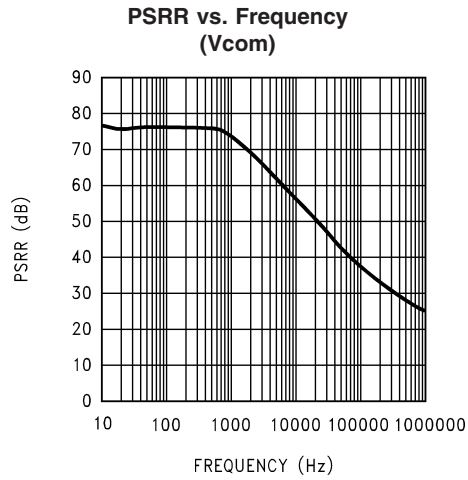

Operation

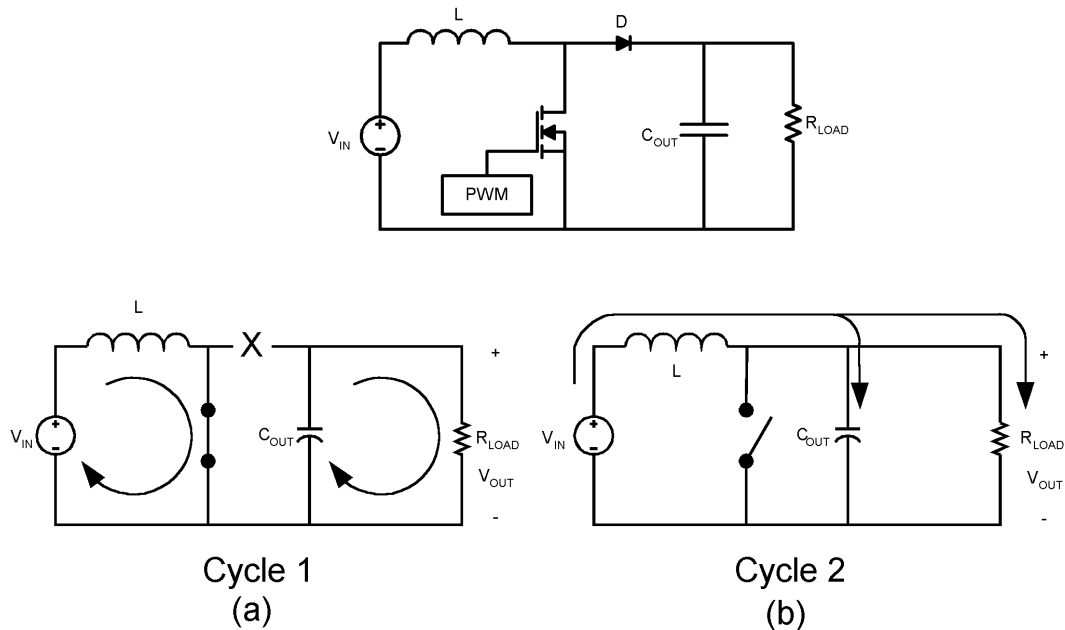

20051102

FIGURE 1. Simplified Boost Converter Diagram
(a) First Cycle of Operation (b) Second Cycle Of Operation

CONTINUOUS CONDUCTION MODE

The LM2702 is a TFT Panel Module containing a current-mode, PWM boost regulator. A boost regulator steps the input voltage up to a higher output voltage. In continuous conduction mode (when the inductor current never reaches zero at steady state), the boost regulator operates in two cycles.

In the first cycle of operation, shown in *Figure 1 (a)*, the transistor is closed and the diode is reverse biased. Energy is collected in the inductor and the load current is supplied by C_{OUT} .

The second cycle is shown in *Figure 1 (b)*. During this cycle, the transistor is open and the diode is forward biased. The energy stored in the inductor is transferred to the load and output capacitor.

The ratio of these two cycles determines the output voltage. The output voltage is defined approximately as:

$$V_{OUT} = \frac{V_{IN}}{1-D}, D' = (1-D) = \frac{V_{IN}}{V_{OUT}}$$

where D is the duty cycle of the switch, D and D' will be required for design calculations

SETTING THE OUTPUT VOLTAGE

The output voltage is set using the feedback pin and a resistor divider connected to the output as shown in the typical operating circuit. The feedback pin voltage is 1.265V, so the ratio of the feedback resistors sets the output voltage according to the following equation:

$$R1 = R2 \left(\frac{V_{OUT}}{1.265V} - 1 \right)$$

SOFT-START CAPACITOR

The LM2702 has patented internal circuitry that is used to limit the inductor inrush current on start-up of the boost DC/DC switching regulator. This inrush current limiting circuitry serves as a soft-start. However, many applications may require much more soft-start than what is available with the internal circuitry. The external SS pin is used to tailor the soft-start for a specific application. A 12 μ A current charges the external soft-start capacitor, C_{SS} . The soft-start time can be estimated as:

$$T_{SS} = C_{SS} * 0.6V / 12\mu A$$

The minimum soft-start time is set by the internal soft-start circuitry, typically 7ms. Only longer soft-start times may be implemented using the SS pin and a capacitor C_{SS} . If a shorter time is designed for using the above equation, the internal soft-start circuitry will override it.

Due to the unique nature of the dual internal/external soft-start, care was taken in the design to ensure temperature stable operation. As you can see with the I_{SS} data in the Electrical Characteristics table and the graph "Soft-Start Current vs. V_{IN} " in the *Typical Performance Characteristics*

Operation (Continued)

section, the soft start current has a temperature coefficient and would lead one to believe there would be significant variation with temperature. Though the current has a temperature coefficient the actual programmed external soft start time does not show this extreme of a temperature variation. As you can see in the following transient plots:

$V_{OUT} = 8V$, $V_{IN} = 2.5V$, $R_L = 51\Omega$, $C_{SS} = 330nF$, $T = 4ms/div$.
Trace:

- 1) V_{IN} , 5V/div, DC Coupled
- 2) V_{OUT} , 5V/div, DC Coupled
- 3) I_L , 0.5A/div, DC Coupled
- 4) V_{SW} , 5V/div, DC Coupled

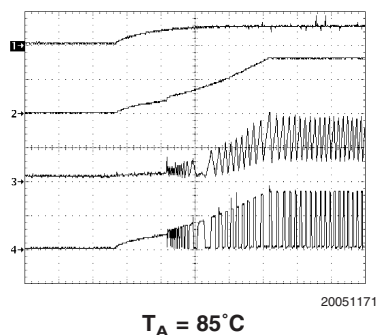
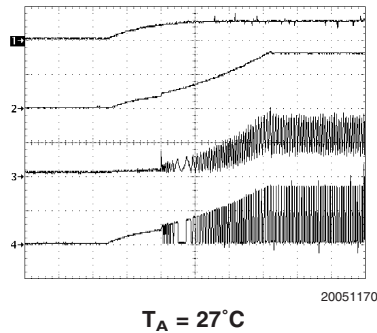
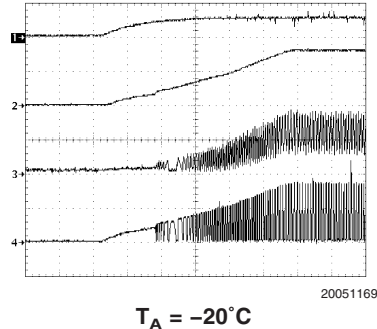

When programming the softstart time externally, simply use the equation given in the *Soft-Start Capacitor* section above. This equation uses the typical room temperature value of the soft start current, $12\mu A$, to set the soft start time.

DELAY CAPACITOR

The LM2702 has internal circuitry that can be used to set a delay time preventing control of the PMOS switch via SWC until a desired amount of time after the switcher starts up. The PMOS control circuitry remains inactive until V_{OUT}

reaches 85% of the nominal output voltage. When this occurs, C_D begins to charge. When the voltage on the Delay pin reaches 1.265V the PMOS switch will become active and can be controlled using the SWC pin. If no C_D is used, the PMOS switch can be controlled immediately after V_{OUT} reaches 85% of the nominal output voltage. The delay time can be calculated using the equation:

$$T_D = C_D * (1.265V/5.7\mu A)$$

INTRODUCTION TO COMPENSATION

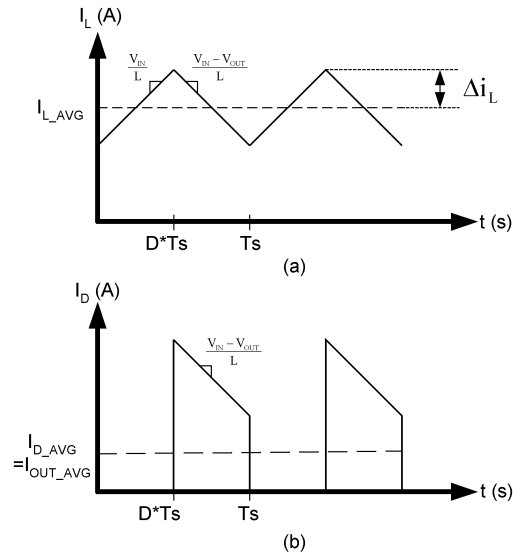

FIGURE 2. (a) Inductor current. (b) Diode current.

The LM2702 contains a current mode PWM boost converter. The signal flow of this control scheme has two feedback loops, one that senses switch current and one that senses output voltage.

To keep a current programmed control converter stable above duty cycles of 50%, the inductor must meet certain criteria. The inductor, along with input and output voltage, will determine the slope of the current through the inductor (see *Figure 2 (a)*). If the slope of the inductor current is too great, the circuit will be unstable above duty cycles of 50%. A $4.7\mu H$ inductor is recommended for most applications. If the duty cycle is approaching the maximum of 85%, it may be necessary to increase the inductance by as much as 2X. See *Inductor and Diode Selection* for more detailed inductor sizing.

The LM2702 provides a compensation pin (V_C) to customize the voltage loop feedback. It is recommended that a series combination of R_C and C_C be used for the compensation network, as shown in the typical application circuit. For any given application, there exists a unique combination of R_C and C_C that will optimize the performance of the LM2702 circuit in terms of its transient response. The series combination of R_C and C_C introduces a pole-zero pair according to the following equations:

$$f_{zc} = \frac{1}{2\pi R_C C_C} \text{ Hz}$$

Operation (Continued)

$$f_{PC} = \frac{1}{2\pi(R_C + R_O)C_C} \text{ Hz}$$

where R_O is the output impedance of the error amplifier, approximately $1M\Omega$. For most applications, performance can be optimized by choosing values within the range $5k\Omega \leq R_C \leq 40k\Omega$ (R_C can be up to $200k\Omega$ if C_{C2} is used, see *High Output Capacitor ESR Compensation*) and $680pF \leq C_C \leq 4.7nF$. Refer to the Typical Application Circuit and the *Applications Information* section for recommended values for specific circuits and conditions. Refer to the *Compensation* section for other design requirement.

COMPENSATION FOR BOOST DC/DC

This section will present a general design procedure to help insure a stable and operational circuit. The designs in this datasheet are optimized for particular requirements. If different conversions are required, some of the components may need to be changed to ensure stability. Below is a set of general guidelines in designing a stable circuit for continuous conduction operation (Inductor current never reaches zero), in most all cases this will provide for stability during discontinuous operation as well. The power components and their effects will be determined first, then the compensation components will be chosen to produce stability.

INDUCTOR AND DIODE SELECTION

Although the inductor size mentioned earlier is fine for most applications, a more exact value can be calculated. To ensure stability at duty cycles above 50%, the inductor must have some minimum value determined by the minimum input voltage and the maximum output voltage. This equation is:

$$L > \frac{V_{IN}R_{DSON}}{0.362 f_s} \left[\frac{D}{D'} - 1 \right] \text{ (in H)}$$

where f_s is the switching frequency, D is the duty cycle, and R_{DSON} is the ON resistance of the internal switch taken from the graph " R_{DSON} vs. V_{IN} " in the *Typical Performance Characteristics* section. This equation is only good for duty cycles greater than 50% ($D > 0.5$), for duty cycles less than 50% the recommended values may be used. The corresponding inductor current ripple as shown in *Figure 2 (a)* is given by:

$$\Delta i_L = \frac{V_{IN}D}{2Lf_s} \text{ (in Amps)}$$

The inductor ripple current is important for a few reasons. One reason is because the peak switch current will be the average inductor current (input current or I_{LOAD}/D') plus Δi_L . As a side note, discontinuous operation occurs when the inductor current falls to zero during a switching cycle, or Δi_L is greater than the average inductor current. Therefore, continuous conduction mode occurs when Δi_L is less than the average inductor current. Care must be taken to make sure that the switch will not reach its current limit during normal operation. The inductor must also be sized accordingly. It should have a saturation current rating higher than the peak inductor current expected. The output and input voltage ripples are also affected by the total ripple current.

The output diode for a boost regulator must be chosen correctly depending on the output voltage and the output current. The typical current waveform for the diode in continuous conduction mode is shown in *Figure 2 (b)*. The diode must be rated for a reverse voltage equal to or greater than the output voltage used. The average current rating must be greater than the maximum load current expected, and the peak current rating must be greater than the peak inductor current. During short circuit testing, or if short circuit conditions are possible in the application, the diode current rating must exceed the switch current limit. Using Schottky diodes with lower forward voltage drop will decrease power dissipation and increase efficiency.

DC GAIN AND OPEN-LOOP GAIN

Since the control stage of the converter forms a complete feedback loop with the power components, it forms a closed-loop system that must be stabilized to avoid positive feedback and instability. A value for open-loop DC gain will be required, from which you can calculate, or place, poles and zeros to determine the crossover frequency and the phase margin. A high phase margin (greater than 45°) is desired for the best stability and transient response. For the purpose of stabilizing the LM2702, choosing a crossover point well below where the right half plane zero is located will ensure sufficient phase margin. A discussion of the right half plane zero and checking the crossover using the DC gain will follow.

INPUT AND OUTPUT CAPACITOR SELECTION

The switching action of a boost regulator causes a triangular voltage waveform at the input. A capacitor is required to reduce the input ripple and noise for proper operation of the regulator. The size used depends on the application and board layout. If the regulator will be loaded uniformly, with very little load changes, and at lower current outputs, the input capacitor size can often be reduced. The size can also be reduced if the input of the regulator is very close to the source output. The size will generally need to be larger for applications where the regulator is supplying nearly the maximum rated output or if large load steps are expected. A minimum value of $10\mu F$ should be used for the less stressful conditions while a $22\mu F$ to $47\mu F$ capacitor may be required for higher power and dynamic loads. Larger values and/or lower ESR may be needed if the application requires very low ripple on the input source voltage.

The choice of output capacitors is also somewhat arbitrary and depends on the design requirements for output voltage ripple. It is recommended that low ESR (Equivalent Series Resistance, denoted R_{ESR}) capacitors be used such as ceramic, polymer electrolytic, or low ESR tantalum. Higher ESR capacitors may be used but will require more compensation which will be explained later on in the section. The ESR is also important because it determines the peak to peak output voltage ripple according to the approximate equation:

$$\Delta V_{OUT} \approx 2\Delta i_L R_{ESR} \text{ (in Volts)}$$

A minimum value of $10\mu F$ is recommended and may be increased to a larger value. After choosing the output capacitor you can determine a pole-zero pair introduced into the control loop by the following equations:

$$f_{P1} = \frac{1}{2\pi(R_{ESR} + R_L)C_{OUT}} \text{ (in Hz)}$$

Operation (Continued)

$$f_{z1} = \frac{1}{2\pi R_{ESR} C_{OUT}} \text{ (in Hz)}$$

Where R_L is the minimum load resistance corresponding to the maximum load current. The zero created by the ESR of the output capacitor is generally very high frequency if the ESR is small. If low ESR capacitors are used it can be neglected. If higher ESR capacitors are used see the *High Output Capacitor ESR Compensation* section.

RIGHT HALF PLANE ZERO

A current mode control boost regulator has an inherent right half plane zero (RHP zero). This zero has the effect of a zero in the gain plot, causing an imposed +20dB/decade on the rolloff, but has the effect of a pole in the phase, subtracting another 90° in the phase plot. This can cause undesirable effects if the control loop is influenced by this zero. To ensure the RHP zero does not cause instability issues, the control loop should be designed to have a bandwidth of less than 1/2 the frequency of the RHP zero. This zero occurs at a frequency of:

$$\text{RHPzero} = \frac{V_{OUT}(D')^2}{2\pi I_{LOAD} L} \text{ (in Hz)}$$

where I_{LOAD} is the maximum load current.

SELECTING THE COMPENSATION COMPONENTS

The first step in selecting the compensation components R_C and C_C is to set a dominant low frequency pole in the control loop. Simply choose values for R_C and C_C within the ranges given in the *Introduction to Compensation* section to set this pole in the area of 10Hz to 500Hz. The frequency of the pole created is determined by the equation:

$$f_{PC} = \frac{1}{2\pi(R_C + R_O)C_C} \text{ (in Hz)}$$

where R_O is the output impedance of the error amplifier, approximately 1MΩ. Since R_C is generally much less than R_O , it does not have much effect on the above equation and can be neglected until a value is chosen to set the zero f_{ZC} . f_{ZC} is created to cancel out the pole created by the output capacitor, f_{P1} . The output capacitor pole will shift with different load currents as shown by the equation, so setting the zero is not exact. Determine the range of f_{P1} over the expected loads and then set the zero f_{ZC} to a point approximately in the middle. The frequency of this zero is determined by:

$$f_{ZC} = \frac{1}{2\pi C_C R_C} \text{ (in Hz)}$$

Now R_C can be chosen with the selected value for C_C . Check to make sure that the pole f_{PC} is still in the 10Hz to 500Hz range, change each value slightly if needed to ensure both component values are in the recommended range. After checking the design at the end of this section, these values can be changed a little more to optimize performance if desired. This is best done in the lab on a bench, checking the load step response with different values until the ringing and overshoot on the output voltage at the edge of the load steps is minimal. This should produce a stable, high performance

circuit. For improved transient response, higher values of R_C should be chosen. This will improve the overall bandwidth which makes the regulator respond more quickly to transients. If more detail is required, or the most optimal performance is desired, refer to a more in depth discussion of compensating current mode DC/DC switching regulators.

HIGH OUTPUT CAPACITOR ESR COMPENSATION

When using an output capacitor with a high ESR value, or just to improve the overall phase margin of the control loop, another pole may be introduced to cancel the zero created by the ESR. This is accomplished by adding another capacitor, C_{C2} , directly from the compensation pin V_C to ground, in parallel with the series combination of R_C and C_C . The pole should be placed at the same frequency as f_{Z1} , the ESR zero. The equation for this pole follows:

$$f_{PC2} = \frac{1}{2\pi C_{C2}(R_C // R_O)} \text{ (in Hz)}$$

To ensure this equation is valid, and that C_{C2} can be used without negatively impacting the effects of R_C and C_C , f_{PC2} must be greater than $10f_{ZC}$.

CHECKING THE DESIGN

The final step is to check the design. This is to ensure a bandwidth of 1/2 or less of the frequency of the RHP zero. This is done by calculating the open-loop DC gain, A_{DC} . After this value is known, you can calculate the crossover visually by placing a -20dB/decade slope at each pole, and a +20dB/decade slope for each zero. The point at which the gain plot crosses unity gain, or 0dB, is the crossover frequency. If the crossover frequency is less than 1/2 the RHP zero, the phase margin should be high enough for stability. The phase margin can also be improved by adding C_{C2} as discussed earlier in the section. The equation for A_{DC} is given below with additional equations required for the calculation:

$$A_{DC(\text{DB})} = 20 \log_{10} \left(\left(\frac{R_{FB2}}{R_{FB1} + R_{FB2}} \right) \frac{g_m R_O D'}{R_{DSON}} \left\{ \left(\omega C_{Leff} // R_L // R_U \right) \right\} \right) \text{ (in dB)}$$

$$\omega C \cong \frac{2fs}{nD'} \text{ (in rad/s)}$$

$$Leff = \frac{L}{(D')^2}$$

$$n = 1 + \frac{2mc}{m1} \text{ (no unit)}$$

$$mc \cong 0.181fs \text{ (in V/s)}$$

$$m1 \cong \frac{V_{IN} R_{DSON}}{L} \text{ (in V/s)}$$

where R_L is the minimum load resistance, V_{IN} is the minimum input voltage, g_m is the error amplifier transconductance found in the *Electrical Characteristics* table, and R_{DSON} is the value chosen from the graph " R_{DSON} vs. V_{IN} " in the *Typical Performance Characteristics* section.

Operation (Continued)

Vcom AND Gamma COMPENSATION

The architecture used for the amplifiers in the LM2702 requires external compensation on the output. Depending on the equivalent capacitive load of the TFT-LCD panel, external components at the amplifier outputs may or may not be necessary. If the capacitance presented by the load is equal to or greater than 5nF no external components are needed as the TFT-LCD panel will act as compensation itself. Distributed resistive and capacitive loads enhance stability and increase performance of the amplifiers. If the capacitance presented by the load is less than 5nF external components will be required as the load itself will not ensure stability. No external compensation in this case will lead to oscillation of the amplifier and an increase in power consumption. A single 5nF or greater capacitor on the output will ensure a stable amplifier with no oscillations. For applications requiring a higher slew rate, a good choice for compensation is to add a 50Ω (R_{COM} or R_{GAMMA}) in series with a 1nF (C_{COM} or C_{GAMMA}) capacitor from the output of the amplifier to ground. This allows for driving zero to infinite capacitance loads with no oscillations, minimal overshoot, and a higher slew rate than using a large capacitor. The high phase margin created by the external compensation will guarantee stability and good performance for all conditions.

For noise sensitive applications greater output capacitance may be desired. When the power supply for the amplifiers (AV_{IN}) is connected to the output of the switching regulator, the output ripple of the regulator will produce ripple at the output of the amplifiers.

LAYOUT CONSIDERATIONS

The LM2702 uses a single ground connection, GND. The feedback, softstart, delay, and compensation networks should be connected directly to a dedicated analog ground plane and this ground plane must connect to the GND pin, as shown in *Figure 3*. If no analog ground plane is available then the ground connections of the feedback, softstart, delay, and compensation networks must tie directly to the GND pin, as shown in *Figure 4*. Connecting these networks to the PGND plane can inject noise into the system and effect performance.

The input bypass capacitor C_{IN} must be placed close to the IC. This will reduce copper trace resistance which effects input voltage ripple of the IC. For additional input voltage filtering, a 100nF bypass capacitor can be placed in parallel with C_{IN} , close to the V_{IN} pin, to shunt any high frequency noise to ground. The output capacitor, C_{OUT} , should also be placed close to the IC. Any copper trace connections for the C_{OUT} capacitor can increase the series resistance, which directly effects output voltage ripple and efficiency. The feedback network, resistors R1 and R2, should be kept close to the FB pin, and away from the inductor, to minimize copper trace connections that can inject noise into the system. Trace connections made to the inductor and schottky diode should be minimized to reduce power dissipation and increase overall efficiency.

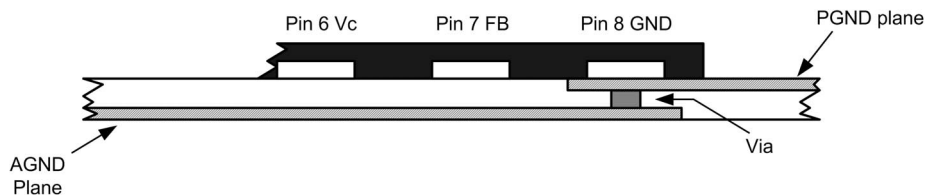

20051152

FIGURE 3. Multi-Layer Layout

Operation (Continued)

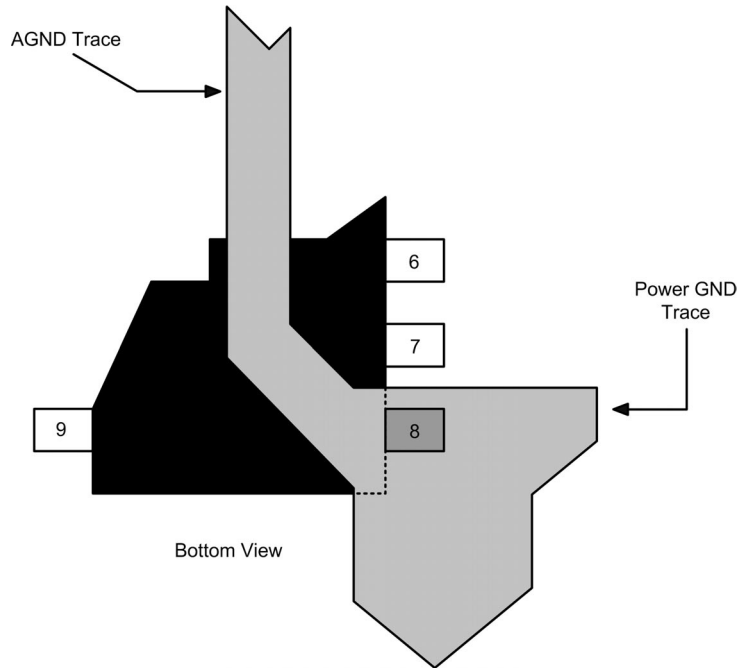

20051153

FIGURE 4. Single Layer Layout

Application Information

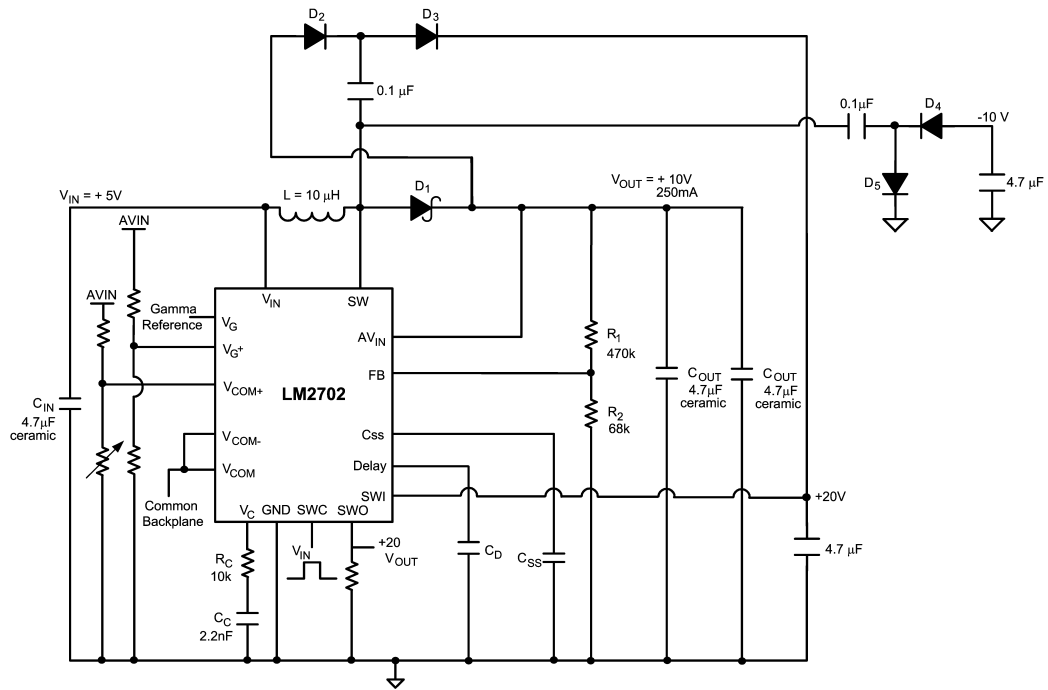

20051172

FIGURE 5. 5V to 10V TFT Application

Physical Dimensions inches (millimeters) unless otherwise noted

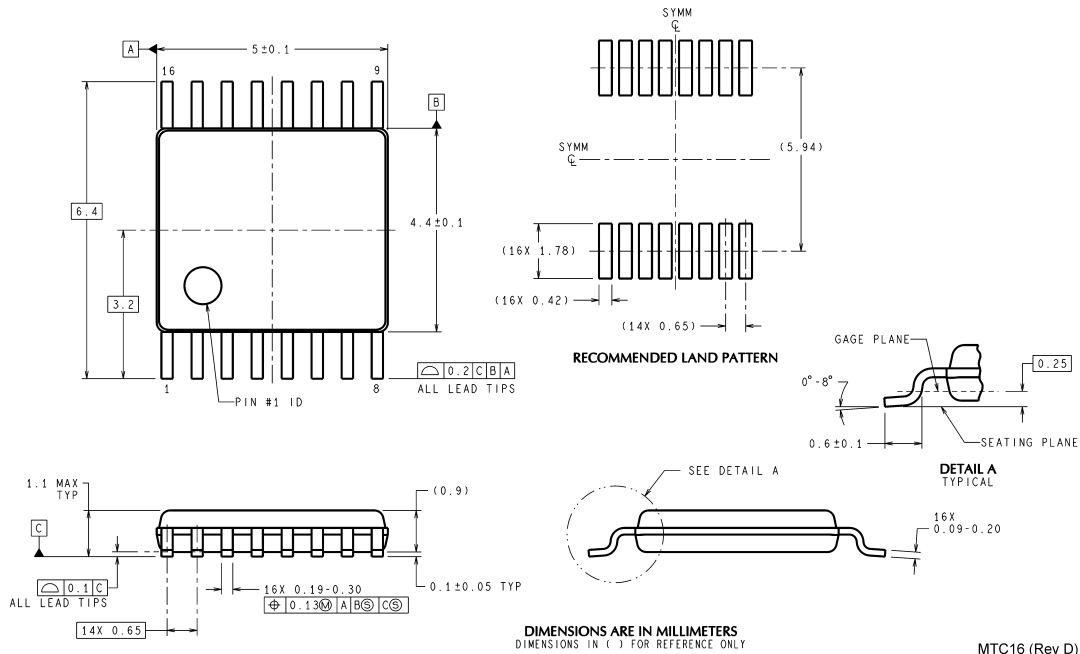

TSSOP-16 Pin Package (MTC)
For Ordering, Refer to Ordering Information Table
NS Package Number MTC16

National does not assume any responsibility for use of any circuitry described, no circuit patent licenses are implied and National reserves the right at any time without notice to change said circuitry and specifications.

For the most current product information visit us at www.national.com.

LIFE SUPPORT POLICY

NATIONAL'S PRODUCTS ARE NOT AUTHORIZED FOR USE AS CRITICAL COMPONENTS IN LIFE SUPPORT DEVICES OR SYSTEMS WITHOUT THE EXPRESS WRITTEN APPROVAL OF THE PRESIDENT AND GENERAL COUNSEL OF NATIONAL SEMICONDUCTOR CORPORATION. As used herein:

1. Life support devices or systems are devices or systems which, (a) are intended for surgical implant into the body, or (b) support or sustain life, and whose failure to perform when properly used in accordance with instructions for use provided in the labeling, can be reasonably expected to result in a significant injury to the user.
2. A critical component is any component of a life support device or system whose failure to perform can be reasonably expected to cause the failure of the life support device or system, or to affect its safety or effectiveness.

BANNED SUBSTANCE COMPLIANCE

National Semiconductor manufactures products and uses packing materials that meet the provisions of the Customer Products Stewardship Specification (CSP-9-111C2) and the Banned Substances and Materials of Interest Specification (CSP-9-111S2) and contain no "Banned Substances" as defined in CSP-9-111S2.



National Semiconductor
Americas Customer Support Center
 Email: new.feedback@nsc.com
 Tel: 1-800-272-9959

National Semiconductor
Europe Customer Support Center
 Fax: +49 (0) 180-530 85 86
 Email: europe.support@nsc.com
 Deutsch Tel: +49 (0) 69 9508 6208
 English Tel: +44 (0) 870 24 0 2171
 Français Tel: +33 (0) 1 41 91 8790

National Semiconductor
Asia Pacific Customer Support Center
 Email: ap.support@nsc.com

National Semiconductor
Japan Customer Support Center
 Fax: 81-3-5639-7507
 Email: jpn.feedback@nsc.com
 Tel: 81-3-5639-7560

www.national.com