



Triple USB Switch with Autoreset and Fault Blanking

MAX1940

General Description

The MAX1940 triple current-limited switch with autoreset supplies a guaranteed 500mA load per channel in accordance with USB specifications. The MAX1940 operates from a 4V to 5.5V input supply and consumes only 60 μ A of quiescent current when operating and only 3 μ A in standby. Selectable active-high/active-low control logic and independent shutdown controls for each channel provide additional flexibility. An autoreset feature latches the switch off in the event of a short circuit, saving system power. The switch reactivates upon removal of the shorted condition.

The MAX1940 provides several safety features to protect the USB port. Built-in thermal-overload protection turns off the switch when the die temperature exceeds +160°C. Accurate internal current-limiting circuitry protects the input supply against both overload and short-circuit conditions. Independent open-drain fault signals (FAULTA, FAULTB, and FAULTC) notify the microprocessor when a thermal-overload, current-limit, undervoltage lockout (UVLO), or short-circuit fault occurs. A 20ms fault-blanking feature enables the circuit to ignore momentary faults, such as those caused when hot-swapping a capacitive load, preventing false alarms to the host system. The fault-blanking feature also prevents fault signals from being issued when the device powers up the load.

The MAX1940 is available in a space-saving 16-pin QSOP package and operates over the extended (-40°C to +85°C) temperature range.

Applications

USB Ports	PDA's and Palmtop Computers
USB Hubs	Computers
Notebook Computers	Docking Stations
Desktop Computers	

Pin Configuration

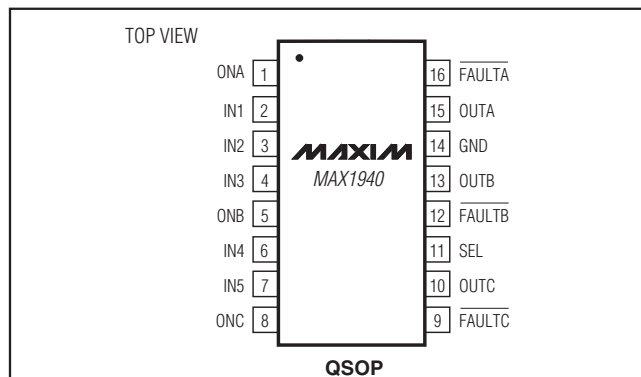

Features

- ◆ Triple USB Switch in Tiny 16-Pin QSOP Package
- ◆ Autoreset Feature Saves System Power
- ◆ Guaranteed 500mA Load Current per Channel
- ◆ Built-In 20ms Fault-Blanking Circuitry
- ◆ Active-High/Active-Low Control Logic
- ◆ Fully Compliant to USB Specifications
- ◆ 4V to 5.5V Input Voltage Range
- ◆ Independent Shutdown Control
- ◆ Independent Fault Indicator Outputs
- ◆ Thermal-Overload Protection
- ◆ 3 μ A Standby Current

Ordering Information

PART	TEMP RANGE	PIN-PACKAGE
MAX1940EEE	-40°C to +85°C	16 QSOP

Typical Operating Circuit

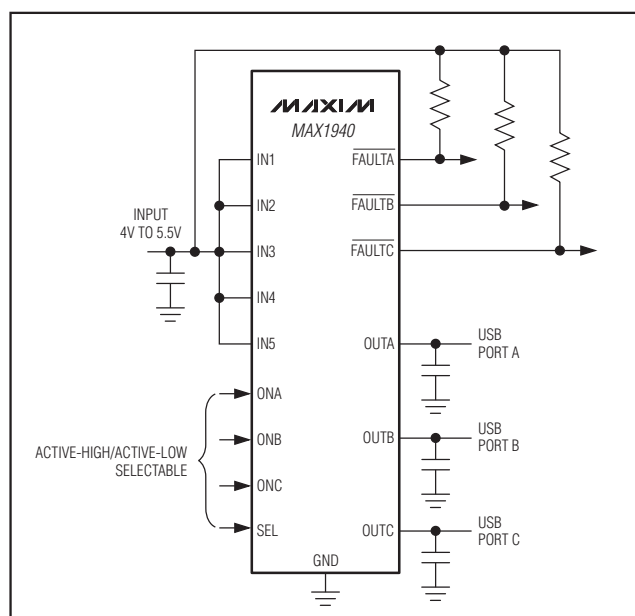

Triple USB Switch with Autoreset and Fault Blanking

ABSOLUTE MAXIMUM RATINGS

IN ₋ , ON ₋ , OUT ₋ , SEL, $\overline{\text{FAULT}}_{-}$, to GND.....	-0.3V to +6V
IN1, IN2 to OUTA.....	-0.3V to +6V
IN2, IN3 to OUTB.....	-0.3V to +6V
IN4, IN5 to OUTC.....	-0.3V to +6V
OUT ₋ Continuous Switch Current (per channel, internally limited).....	1.4A
FAULT ₋ DC Current.....	20mA

Continuous Power Dissipation (T _A = +70°C) 16-Pin QSOP (derate 8.3mW/°C above +70°C).....	667mW
Operating Temperature Range.....	-40°C to +85°C
Junction Temperature.....	+150°C
Storage Temperature Range.....	-65°C to +150°C
Lead Temperature (soldering, 10s).....	+300°C

Stresses beyond those listed under "Absolute Maximum Ratings" may cause permanent damage to the device. These are stress ratings only, and functional operation of the device at these or any other conditions beyond those indicated in the operational sections of the specifications is not implied. Exposure to absolute maximum rating conditions for extended periods may affect device reliability.

ELECTRICAL CHARACTERISTICS

(V_{IN-} = 5V, C_{IN-} = 0.1μF, C_{OUT-} = 1μF, T_A = 0°C to +85°C, unless otherwise noted. Typical values are at T_A = +25°C.)

PARAMETER	SYMBOL	CONDITIONS	MIN	TYP	MAX	UNITS
Supply Voltage Range	V _{IN-}		4.0		5.5	V
Switch On-Resistance	R _{ON}	T _A = 0°C to +85°C, each switch		85	135	mΩ
Standby Supply Current		All switches disabled		3	10	μA
Quiescent Supply Current	I _{IN-}	One switch enabled, I _{OUT-} = 0		47	75	μA
		Two switches enabled, I _{OUT-} = 0		55	90	
		All switches enabled, I _{OUT-} = 0		63	100	
OUT ₋ Off-Leakage Current	I _{LKG}	All switches disabled, V _{OUT-} = 0, T _A = 0°C to +85°C		0.02	10	μA
Undervoltage Lockout Threshold	V _{ULVO}	Rising edge, 3% hysteresis	3.0	3.4	3.8	V
Continuous Load Current			500			mA
Continuous Current Limit	I _{LIM}	V _{IN-} - V _{OUT-} = 0.5V	0.7	0.9	1.2	A
Short-Circuit Current Limit	I _{SC}	V _{OUT-} = 0 (I _{OUT-} pulsing)	0.9	1.2	1.6	APK
				0.35		ARMS
Short-Circuit Detect Threshold		(Note 1)		1		V
Continuous Current-Limit Blanking Timeout Period		From continuous current-limit condition to $\overline{\text{FAULT}}_{-}$ asserted	10	20	35	ms
Short-Circuit Blanking Timeout Period		From short-circuit current-limit condition to $\overline{\text{FAULT}}_{-}$ asserted	7.5	18	35.0	ms
Turn-On Delay	t _{ON}	R _{OUT-} = 10Ω, does not include rise time (from ON ₋ to 10% of V _{OUT-})	0.5	1.2	4.0	ms
Output Rise Time	t _{RISE}	R _{OUT-} = 10Ω, from 10% to 90% of V _{OUT-}		2.5		ms
Turn-Off Delay	t _{OFF}	R _{OUT-} = 10Ω, does not include fall time (from ON ₋ to 90% of V _{OUT-})		0.8	3	ms
Output Fall Time	t _{FALL}	R _{OUT-} = 10Ω, from 90% to 10% of V _{OUT-}		2.5		ms
Thermal-Shutdown Threshold		15°C hysteresis		160		°C
ON ₋ , SEL Input High Level	V _{IH}	V _{IN-} = 4V to 5.5V	2			V
ON ₋ , SEL Input Low Level	V _{IL}	V _{IN-} = 4V to 5.5V			0.8	V
ON ₋ , SEL Input Leakage Current		V _{ON-} = 0 or V _{IN-}	-1		+1	μA

Triple USB Switch with Autoreset and Fault Blanking

MAX1940

ELECTRICAL CHARACTERISTICS (continued)

($V_{IN_} = 5V$, $C_{IN_} = 0.1\mu F$, $C_{OUT_} = 1\mu F$, $T_A = 0^\circ C$ to $+85^\circ C$, unless otherwise noted. Typical values are at $T_A = +25^\circ C$.)

PARAMETER	SYMBOL	CONDITIONS	MIN	TYP	MAX	UNITS
FAULT_ Output Low Voltage	V_{OL}	$I_{SINK} = 1mA$, $V_{IN_} = 4V$			0.4	V
FAULT_ Output High Leakage Current		$V_{IN_} = V_{FAULT_} = 5.5V$			1	μA
OUT_ Autoreset Current		In latched off state, $V_{OUT_} = 0$	10	25	45	mA
OUT_ Autoreset Threshold		In latched off state, OUT_ rising	0.4	0.5	0.6	V
OUT_ Autoreset Blanking Time		In latched off state, $V_{OUT_} > 0.5V$	10	20	35	ms

ELECTRICAL CHARACTERISTICS

($V_{IN_} = 5V$, $C_{IN_} = 0.1\mu F$, $C_{OUT_} = 1\mu F$, $T_A = -40^\circ C$ to $+85^\circ C$, unless otherwise noted.) (Note 2)

PARAMETER	SYMBOL	CONDITIONS	MIN	MAX	UNITS	
Supply Voltage Range	$V_{IN_}$		4.0	5.5	V	
Switch On-Resistance	R_{ON}	Each switch		135	$m\Omega$	
Standby Supply Current		All switches disabled		10	μA	
Quiescent Supply Current	$I_{IN_}$	One switch enabled, $I_{OUT_} = 0$		75	μA	
		Two switches enabled, $I_{OUT_} = 0$		90		
		All switches enabled, $I_{OUT_} = 0$		100		
OUT_ Off-Leakage Current	I_{LKG}	All switches disabled, $V_{OUT_} = 0$		10	μA	
Undervoltage Lockout Threshold	V_{ULVO}	Rising edge, 3% hysteresis	3.0	3.8	V	
Continuous Load Current			500		mA	
Continuous Current Limit	I_{LIM}	$V_{IN_} - V_{OUT_} = 0.5V$	0.7	1.2	A	
Short-Circuit Current Limit	I_{SC}	$V_{OUT_} = 0$ ($I_{OUT_}$ pulsing)	0.9	1.6	APK	
Continuous Current-Limit Blanking Timeout Period		From continuous current-limit condition to FAULT_ asserted	10	35	ms	
Short-Circuit Blanking Timeout Period		From short-circuit current-limit condition to FAULT_ asserted	7.5	35.0	ms	
Turn-On Delay	t_{ON}	$R_{OUT_} = 10\Omega$, does not include rise time (from ON_ to 10% of $V_{OUT_}$)	0.5	4.0	ms	
Turn-Off Delay	t_{OFF}	$R_{OUT_} = 10\Omega$, does not include fall time (from ON_ to 90% of $V_{OUT_}$)		3	ms	
ON_, SEL Input High Level	V_{IH}	$V_{IN_} = 4V$ to $5.5V$	2		V	
ON_, SEL Input Low Level	V_{IL}	$V_{IN_} = 4V$ to $5.5V$		0.8	V	
ON_, SEL Input Leakage Current		$V_{ON_} = 0$ or $V_{IN_}$	-1	+1	μA	
FAULT_ Output Low Voltage	V_{OL}	$I_{SINK} = 1mA$, $V_{IN_} = 4V$			0.4	V
FAULT_ Output High Leakage Current		$V_{IN_} = V_{FAULT_} = 5.5V$			1	μA
OUT_ Autoreset Current		In latched off state, $V_{OUT_} = 0$	10	50	mA	
OUT_ Autoreset Threshold		In latched off state, OUT_ rising	0.4	0.6	V	
OUT_ Autoreset Blanking Time		In latched off state, $V_{OUT_} > 0.5V$	10	35	ms	

Note 1: Short-circuit detect threshold is the output voltage at which the device transitions from short-circuit current limit to continuous current limit.

Note 2: Specifications to $-40^\circ C$ are guaranteed by design, not production tested.

Triple USB Switch with Autoreset and Fault Blanking

Typical Operating Characteristics

(Circuit of Figure 2, $V_{IN_} = 5V$, $C_{IN_} = 0.1\mu F$, $C_{OUT_} = 1\mu F$, $ON_ = SEL$, $T_A = +25^\circ C$, unless otherwise noted.)

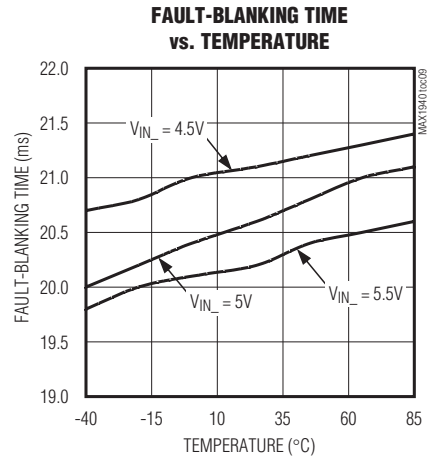
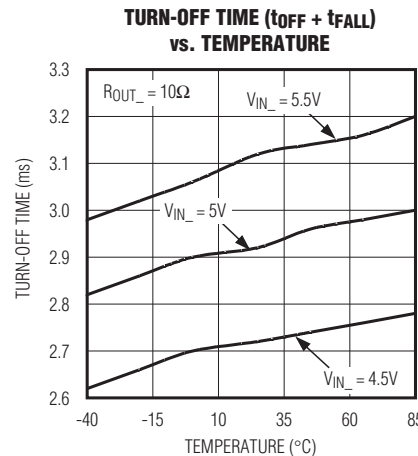
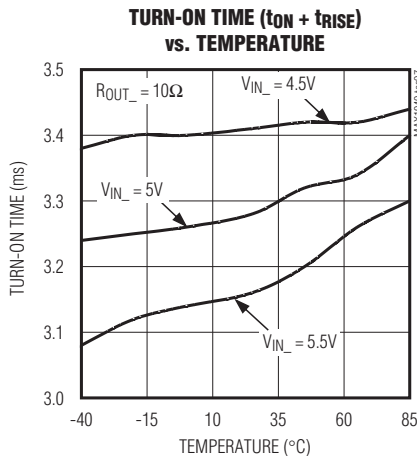
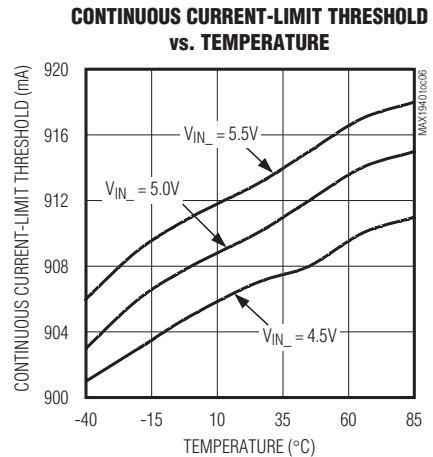
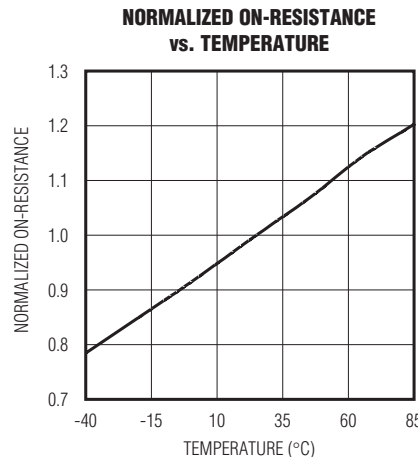
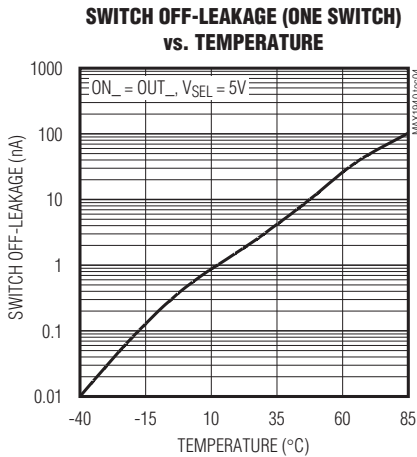
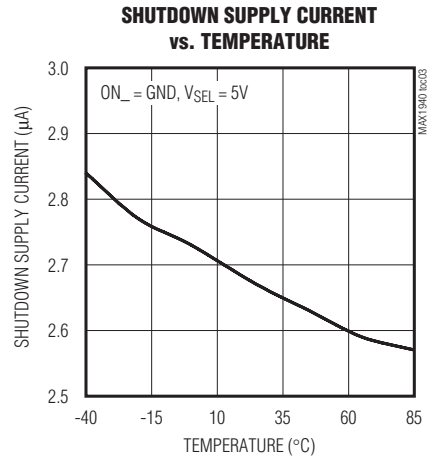
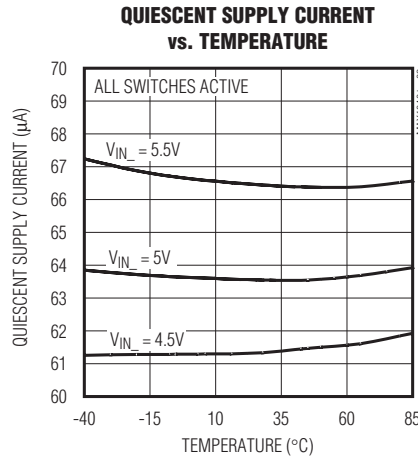
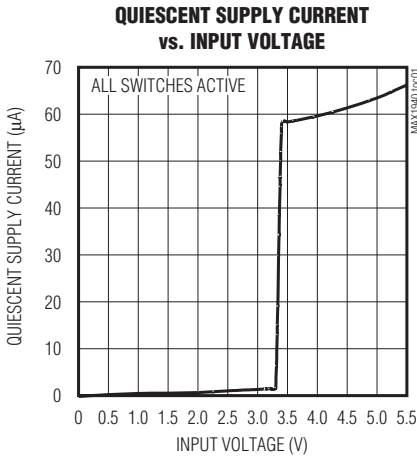

Triple USB Switch with Autoreset and Fault Blanking

MAX1940

Typical Operating Characteristics (continued)

(Circuit of Figure 2, $V_{IN_} = 5V$, $C_{IN_} = 0.1\mu F$, $C_{OUT_} = 1\mu F$, $ON_ = SEL$, $T_A = +25^\circ C$, unless otherwise noted.)

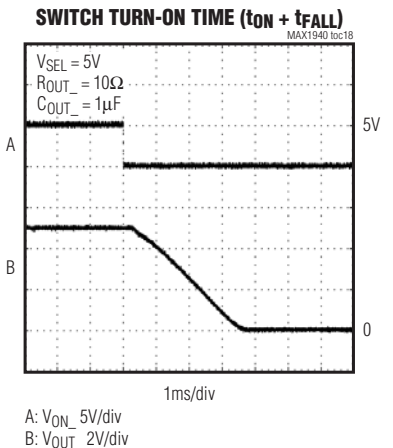
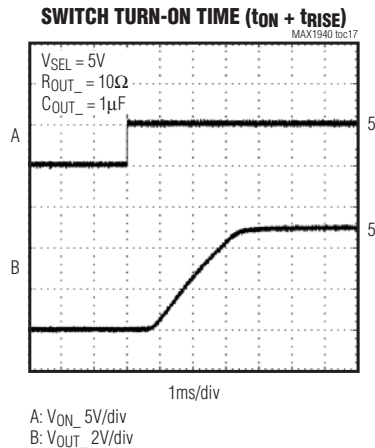
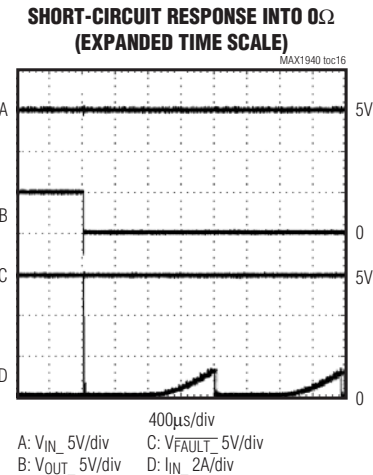
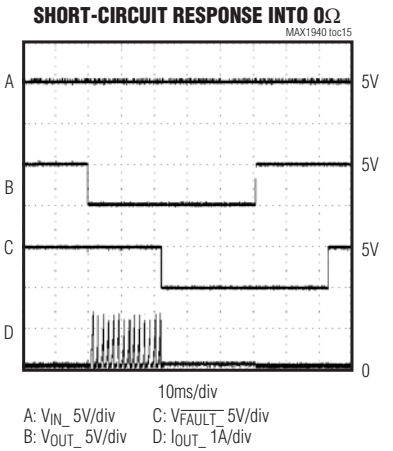
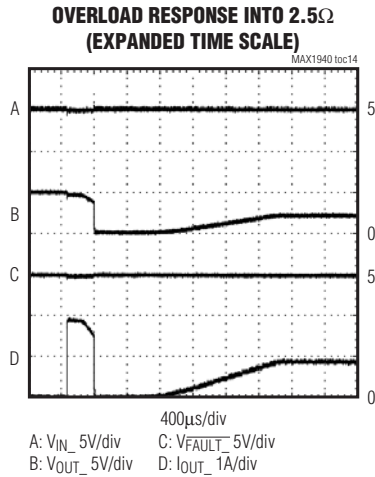
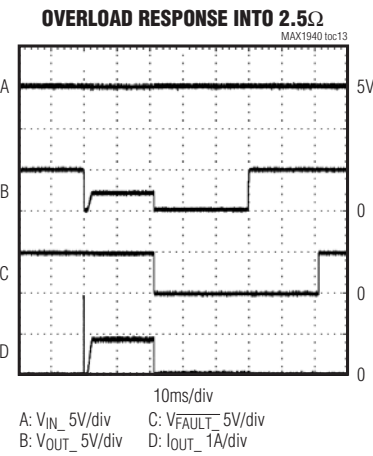
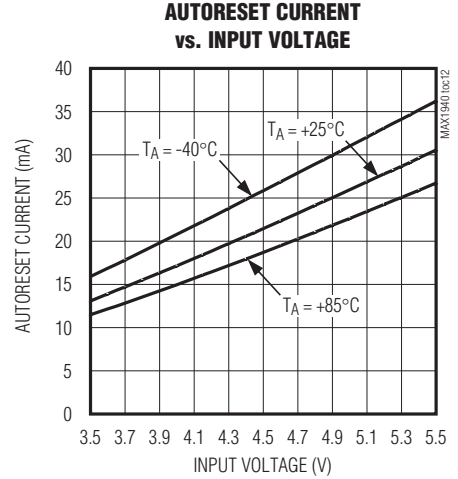
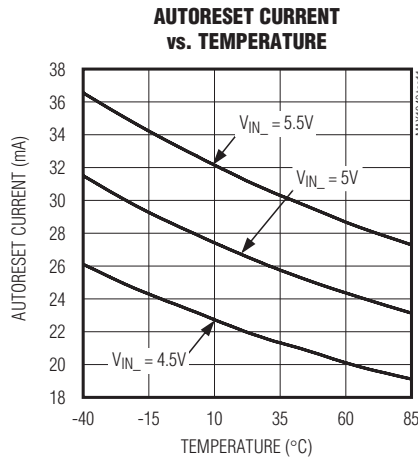
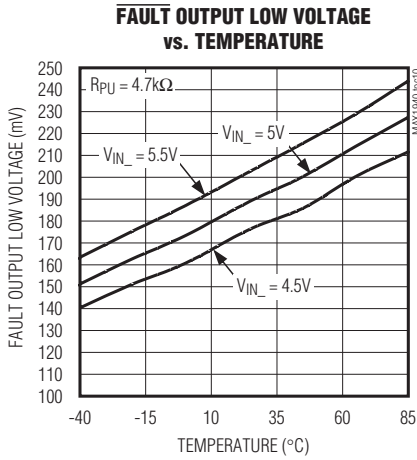

Triple USB Switch with Autoreset and Fault Blanking

Typical Operating Characteristics (continued)

(Circuit of Figure 2, $V_{IN_} = 5V$, $C_{IN_} = 0.1\mu F$, $C_{OUT_} = 1\mu F$, $ON_ = SEL$, $T_A = +25^\circ C$, unless otherwise noted.)

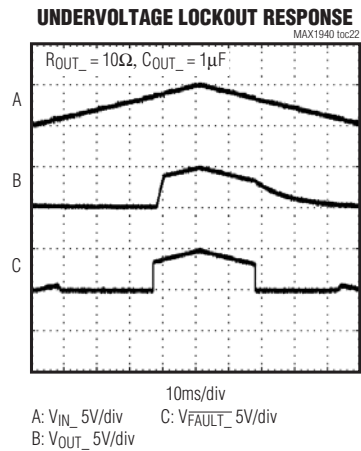
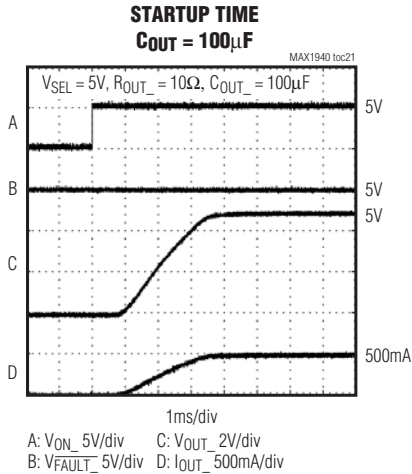
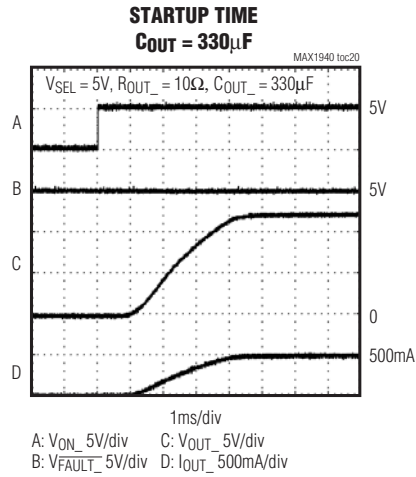
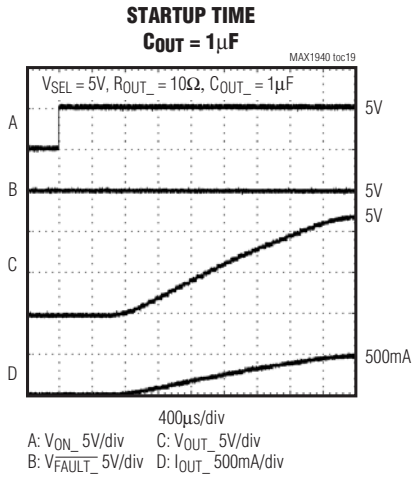

Triple USB Switch with Autoreset and Fault Blanking

Pin Description

MAX1940

PIN	NAME	FUNCTION
1	ONA	Control Input for Switch A. The active polarity of ONA is set by SEL (see Table 1).
2	IN1	Power Input. Connect all IN_ inputs together and bypass with a 0.1μF ceramic capacitor to GND. Load conditions might require additional bulk capacitance to prevent pulling IN_ down.
3	IN2	Power Input. Connect all IN_ inputs together and bypass with a 0.1μF ceramic capacitor to GND. Load conditions might require additional bulk capacitance to prevent pulling IN_ down.
4	IN3	Power Input. Connect all IN_ inputs together and bypass with a 0.1μF ceramic capacitor to GND. Load conditions might require additional bulk capacitance to prevent pulling IN_ down.
5	ONB	Control Input for Switch B. The active polarity of ONB is set by SEL (see Table 1).
6	IN4	Power Input. Connect all IN_ inputs together and bypass with a 0.1μF ceramic capacitor to GND. Load conditions might require additional bulk capacitance to prevent pulling IN_ down.
7	IN5	Power Input. Connect all IN_ inputs together and bypass with a 0.1μF ceramic capacitor to GND. Load conditions might require additional bulk capacitance to prevent pulling IN_ down.
8	ONC	Control Input for Switch C. The active polarity of ONC is set by SEL (see Table 1).
9	$\overline{\text{FAULTC}}$	Fault Indicator Output for Switch C. Open-drain output asserts low when switch C enters thermal shutdown, undervoltage lockout, or a sustained (>20ms) current-limit or short-circuit condition.
10	OUTC	Power Output for Switch C. Bypass OUTC to GND with a 1μF ceramic capacitor. Load conditions might require additional bulk capacitance. When disabled, OUTC goes into a high-impedance state.
11	SEL	Logic Input Polarity Select. SEL sets the active polarity of the ON_ inputs. Connect SEL high to set active-high inputs. Connect SEL to GND to set active-low inputs.
12	$\overline{\text{FAULTB}}$	Fault Indicator Output for Switch B. Open-drain output asserts low when switch B enters thermal shutdown, undervoltage lockout, or enters a sustained (>20ms) current-limit or short-circuit condition.
13	OUTB	Power Output for Switch B. Bypass OUTB to GND with a 1μF ceramic capacitor. Load conditions might require additional bulk capacitance. When disabled, OUTB goes into a high-impedance state.
14	GND	Ground
15	OUTA	Power Output for Switch A. Bypass OUTA to GND with a 1μF ceramic capacitor. Load conditions might require additional bulk capacitance. When disabled, OUTA goes into a high-impedance state.
16	$\overline{\text{FAULTA}}$	Fault Indicator Output for Switch A. Open-drain output asserts low when switch A enters thermal shutdown, undervoltage lockout, or a sustained (>20ms) current-limit or short-circuit condition.

Triple USB Switch with Autoreset and Fault Blanking

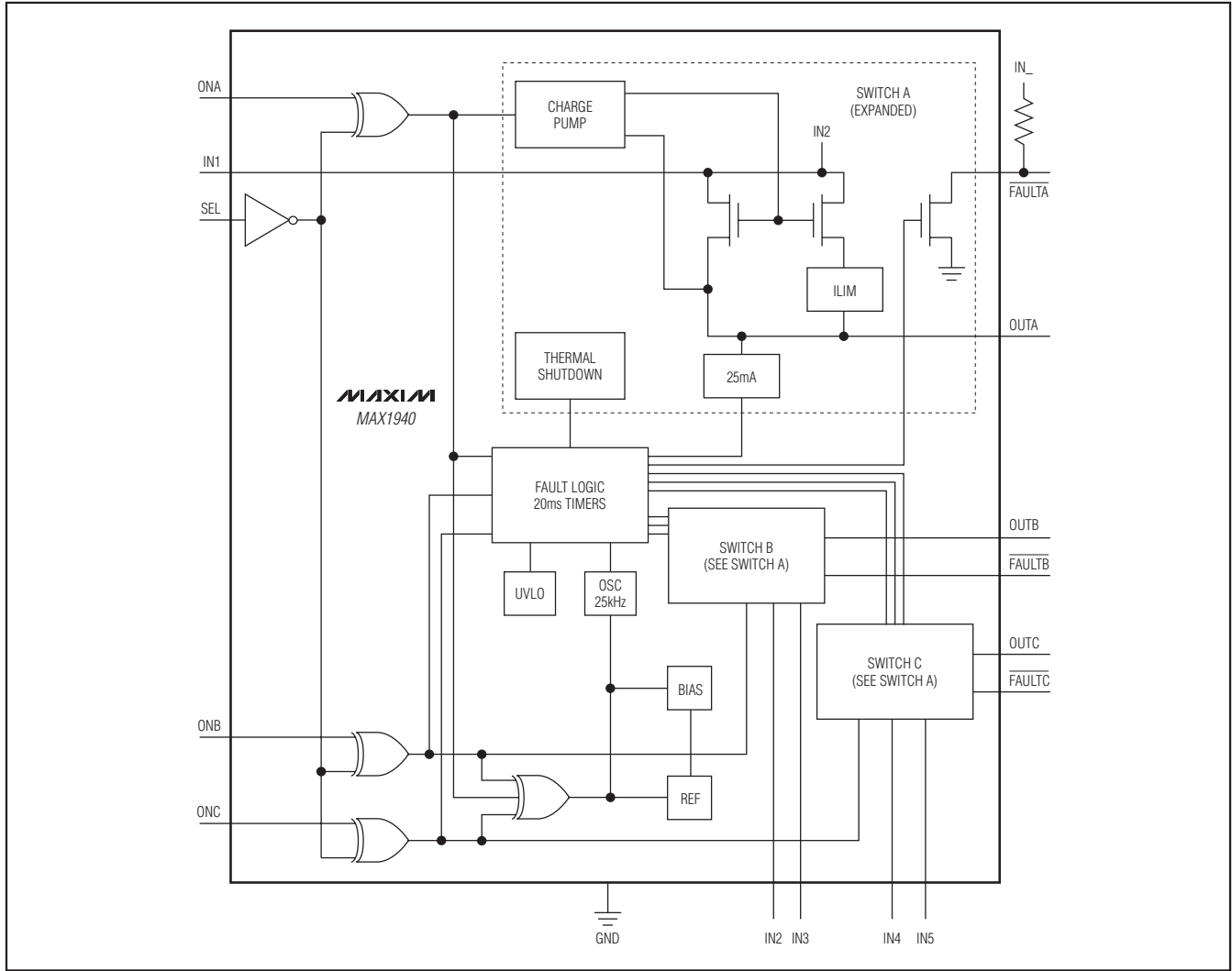

Figure 1. Functional Diagram

Detailed Description

The MAX1940 triple current-limited USB power switch provides three independent switches, each with its own enable-control input and fault indicator (see Figure 1). A logic input sets the active polarity of the enable control inputs. The fault indicators notify the system when the current-limit, short-circuit, undervoltage lockout, or thermal-shutdown threshold is exceeded.

The MAX1940 operates from a 4V to 5.5V input supply and supplies a minimum output current of 700mA per channel. A built-in current limit of 0.9A (typ) limits the output current in the event of an overload condition. Built-in short-circuit detection pulses the output current if

the output voltage falls below 1V, resulting in lower RMS output current and reduced power dissipation in the device. Independent thermal shutdown allows normal operation to continue if one channel experiences a prolonged overload or short-circuit condition.

Low- R_{ON} NMOS switches enable the MAX1940 to provide three switches in the space-saving 16-pin QSOP package. An internal micropower charge pump generates the high-side supply needed for driving the gates of these high-side switches. Separate current-limiting and thermal-shutdown circuitry permits each switch to operate independently, improving system robustness.

Triple USB Switch with Autoreset and Fault Blanking

On/Off Control and Undervoltage Lockout

SEL sets the active polarity of the logic inputs of the MAX1940. Connect ON_n to the same voltage as SEL to enable the respective OUT_n switch. Connect ON_n to the opposite voltage as SEL to disable the respective output (see Table 1). The output of a disabled switch enters a high-impedance state.

The MAX1940 includes a UVLO circuit to prevent erroneous switch operation when the input voltage goes low during startup and brownout conditions. Input voltages of less than 3.4V inhibit operation of the device. $\overline{\text{FAULT}}_n$ asserts low during an undervoltage lockout condition.

Output Fault Protection and Autoreset

The MAX1940 senses the switch output voltage and selects continuous current limiting for V_{OUT_n} greater than 1V, or short-circuit current limiting for V_{OUT_n} less than 1V. When V_{OUT_n} is greater than 1V, the device operates in a continuous current-limit mode that limits output current to 0.9A. When V_{OUT_n} is less than 1V, the device operates in short-circuit current-limit mode, sourcing 1.2A pulses to the load. When either fault condition persists for 20ms, the output turns off and its fault flag is asserted. The output automatically restarts 20ms after the short or overload is removed.

The MAX1940 detects short-circuit removal by sourcing 25mA from the output and monitoring the output voltage. When the voltage at the output exceeds 0.5V for 20ms, the fault flag resets, the output turns back on, and the 25mA current source turns off. Active loads are not expected to have measurable current when supplied with less than 0.5V.

Thermal Shutdown

Independent thermal shutdown for each channel permits normal operation of two switches to continue while a third experiences a thermal fault. The switch turns off and the $\overline{\text{FAULT}}_n$ output asserts low immediately when the junction temperature exceeds +160°C. Thermal shutdown does not utilize the 20ms fault-blanking time-out period. The switch turns on again and $\overline{\text{FAULT}}_n$ returns high when the junction temperature cools by +15°C. The switch cycles on and off if the overload condition persists, resulting in a pulsed output that reduces system power.

Table 1. On/Off Control

SEL	ON _n	OUT _n BEHAVIOR
GND	GND	ON
	V _{IN}	OFF
V _{IN}	GND	OFF
	V _{IN}	ON

Fault Indicators

The MAX1940 provides an independent open-drain fault output ($\overline{\text{FAULT}}_n$) for each switch. Connect $\overline{\text{FAULT}}_n$ to IN_n through a 100kΩ pullup resistor for most applications. $\overline{\text{FAULT}}_n$ asserts low when any of the following conditions occur:

- The input voltage is below the UVLO threshold.
- The switch junction temperature exceeds the +160°C thermal-shutdown temperature limit.
- The switch is in current-limit or short-circuit current-limit mode after the fault-blanking period (20ms) expires.

The $\overline{\text{FAULT}}_n$ output deasserts after a 20ms delay once the fault condition is removed. Ensure that the MAX1940 input bypass capacitance prevents glitches from triggering the $\overline{\text{FAULT}}_n$ outputs. Limit the input voltage slew rate to 0.2V/μs to prevent erroneous $\overline{\text{FAULT}}_n$ indications.

To differentiate large capacitive loads from short circuits or sustained overloads, the MAX1940 has an independent fault-blanking circuit for each switch. When a load transient causes the device to enter current limit, an internal counter monitors the duration of the fault. For load faults exceeding the 20ms fault-blanking time, the switch turns off, $\overline{\text{FAULT}}_n$ asserts low, and the device enters autoreset mode (see the *Output Fault Protection and Autoreset Mode* section). Only current-limit and short-circuit faults are blanked. Thermal overload faults and input voltage drops below the UVLO threshold immediately turn the switch off and assert $\overline{\text{FAULT}}_n$ low.

Fault blanking allows the MAX1940 to handle USB loads that might not be fully compliant with USB specifications. The MAX1940 successfully powers USB loads with additional bypass capacitance and/or large start-up currents while protecting the upstream power source. No fault is reported if the switch brings up the load within the 20ms blanking period. See Table 2 for a summary of current-limit and fault behavior.

Triple USB Switch with Autoreset and Fault Blanking

Table 2. Current-Limiting and Fault Behavior

CONDITION	MAX1940 BEHAVIOR
Output Short Circuit ($V_{OUT_} < 1V$)	<p>If a short is detected at the output, the channel turns off, and the blanking timer begins. $\overline{FAULT_}$ remains high during the blanking timeout period.</p> <p>If the short persists during the fault-blanking period, the output pulses at $0.35A_{RMS}$. If the short is removed before the 18ms short-circuit blanking timeout period, the next ramped current pulse soft-starts the output. $\overline{FAULT_}$ remains high.</p> <p>If the short circuit persists after the fault-blanking period, $\overline{FAULT_}$ goes low, autoreset mode begins, and the output sources 25mA.</p> <p>If the output voltage rises above 0.5V for 20ms, the output turns on and $\overline{FAULT_}$ goes high (see Short-Circuit Response in the <i>Typical Operating Characteristics</i>.)</p>
Output Overload Current ($V_{OUT_} > 1V$)	<p>Output current regulates at I_{LIM} and the blanking timer turns on. $\overline{FAULT_}$ remains high during the blanking timeout period.</p> <p>Continuous current at I_{LIM} persists until either the 20ms blanking period expires or a thermal fault occurs. If overcurrent persists after 20ms, $\overline{FAULT_}$ goes low, autoreset mode is enabled, and the output sources 25mA.</p> <p>If the output voltage rises above 0.5V for 20ms, the output turns on and $\overline{FAULT_}$ goes high (see Overload Response into 2.5Ω in the <i>Typical Operating Characteristics</i>.)</p>
Thermal Fault ($T_J > +160^\circ C$)	<p>A junction temperature of $+160^\circ C$ immediately asserts $\overline{FAULT_}$ low (the blanking timeout period does not apply for thermal faults) and turns off the switch. When the junction cools by $15^\circ C$, the thermal fault is cleared and $\overline{FAULT_}$ goes high. Note that if other fault conditions are present when a thermal fault clears, those fault states take effect.</p>

Applications Information

Input Power Supply and Capacitance

Connect all $IN_$ inputs together externally. $IN_$ powers the internal control circuitry and charge pump for each switch. Bypass $IN_$ to GND with a $0.1\mu F$ ceramic capacitor. When driving inductive loads or operating from inductive sources, which may occur when the MAX1940 is powered by long leads or PC traces, larger input bypass capacitance is required to prevent voltage spikes from exceeding the MAX1940's absolute maximum ratings during short-circuit events.

Output Capacitor

Bypass $OUT_$ to GND with a $1\mu F$ ceramic capacitor for local decoupling. Additional bulk capacitance (up to $470\mu F$) reduces output-voltage transients under dynamic load conditions. Using output capacitors greater than $470\mu F$ might assert $\overline{FAULT_}$ if the current limit cannot charge the output capacitor within the 20ms fault-blanking period. In addition to bulk capacitance, small-value ($0.1\mu F$ or greater) ceramic capacitors improve the output's resilience to electrostatic discharge (ESD).

Driving Inductive Loads

A wide variety of devices (mice, keyboards, cameras, and printers) typically connect to the USB port with

cables, which might add an inductive component to the load. This inductance causes the output voltage at the USB port to oscillate during a load step. The MAX1940 drives inductive loads, but avoid exceeding the device's absolute maximum ratings. Usually, the load inductance is relatively small, and the MAX1940's input includes a substantial bulk capacitance from an upstream regulator as well as local bypass capacitors, limiting overshoot. If severe ringing occurs because of large load inductance, clamp the MAX1940 outputs below $+6V$ and above $-0.3V$.

Turn-On and Turn-Off Behavior

The MAX1940's slow turn-on and turn-off minimizes load transients on the upstream power source. Under fault conditions, the outputs of the MAX1940 turn off rapidly to provide maximum safety for the upstream power source and downstream devices. Internal blocks shut down to minimize supply current when all three channels are off.

Layout and Thermal Dissipation

Keep all traces as short as possible to reduce the effect of undesirable parasitic inductance and optimize the switch response time to output short-circuit conditions. Place input and output capacitors no more than 5mm from device leads. Connect $IN_$ and $OUT_$ to the

Triple USB Switch with Autoreset and Fault Blanking

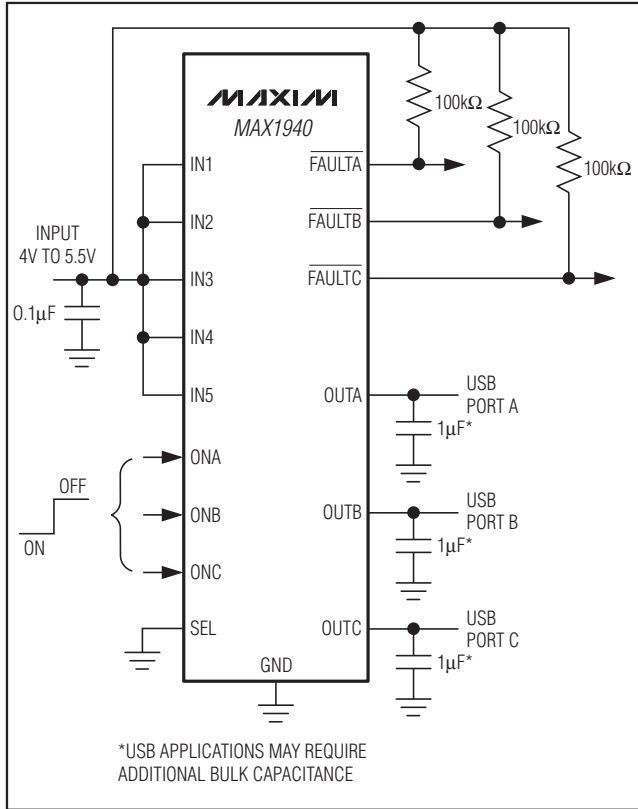

Figure 2. Typical Application Circuit

power bus with short traces. Wide power bus planes at IN_n and OUT provide superior heat dissipation as well.

An active switch dissipates little power with minimal change in package temperature. Calculate the power dissipation for this condition as follows:

$$P = (I_{OUT_})^2 \times R_{ON}$$

At the normal operating current ($I_{OUT_} = 0.5A$) and the maximum on-resistance of the switch ($135m\Omega$), the power dissipation is:

$$P = (0.5A)^2 \times 0.135\Omega = 34mW \text{ per switch.}$$

The worst-case power dissipation occurs when the output current is just below the current-limit threshold ($1.2A$ max) with an output voltage greater than $1V$. In this case, the power dissipated in each switch is the voltage drop across the switch multiplied by the current limit:

$$P = I_{LIM} \times (V_{IN} - V_{OUT})$$

For a $5V$ input and $1V$ output, the maximum power dissipation per switch is:

$$P = 1.2A \times (5V - 1V) = 4.8W$$

Because the package power dissipation is $667mW$, the MAX1940 die temperature exceeds the $+160^\circ C$ thermal shutdown threshold, and the switch output shuts down until the junction temperature cools by $+15^\circ C$. The duty cycle and period are strong functions of the ambient temperature and the PC board layout (see the *Thermal Shutdown* section).

If the output current exceeds the current-limit threshold, or the output voltage is pulled below the short-circuit detect threshold, the MAX1940 enters a fault state after $20ms$, at which point autoreset mode is enabled and $25mA$ is sourced by the output. For a $5V$ input, OUT_n short-circuited to GND, and autoreset mode active, the power dissipation is as follows:

$$P = 0.025A \times 5V = 0.125W$$

Triple USB Switch with Autoreset and Fault Blanking

Chip Information

PROCESS: BiCMOS

Package Information

For the latest package outline information and land patterns, go to www.maxim-ic.com/packages. Note that a "+", "#", or "-" in the package code indicates RoHS status only. Package drawings may show a different suffix character, but the drawing pertains to the package regardless of RoHS status.

PACKAGE TYPE	PACKAGE CODE	DOCUMENT NO.
16 QSOP	E16-5	21-0055

Triple USB Switch with Autoreset and Fault Blanking

Revision History

REVISION NUMBER	REVISION DATE	DESCRIPTION	PAGES CHANGED
0	7/02	Initial release	—
1	2/10	Removed UL Certification Pending bullet from <i>Features</i> section	1

MAX1940

Maxim cannot assume responsibility for use of any circuitry other than circuitry entirely embodied in a Maxim product. No circuit patent licenses are implied. Maxim reserves the right to change the circuitry and specifications without notice at any time.

Maxim Integrated Products, 120 San Gabriel Drive, Sunnyvale, CA 94086 408-737-7600 _____ 13

© 2010 Maxim Integrated Products

Maxim is a registered trademark of Maxim Integrated Products, Inc.