

High Efficiency USB Power Manager Plus 1A Buck-Boost Converter with I²C Control

FEATURES

Power Manager

- High Efficiency Switching PowerPath™ Controller with Bat-Track™ Adaptive Output Control
- Programmable USB or Wall Current Limit (100mA/500mA/1A)
- Full Featured Li-Ion/Polymer Battery Charger
- “Instant-On” Operation with a Discharged Battery
- 1.5A Maximum Charge Current
- Internal 180mΩ Ideal Diode Plus External Ideal Diode Controller Powers Load in Battery Mode
- Low No-Load I_Q When Powered from BAT (<30μA)

1A Buck-Boost DC/DC

- High Efficiency (1A I_{OUT})
- 2.25MHz Constant Frequency Operation
- Low No-Load Quiescent Current (~13μA)
- Zero Shutdown Current
- I²C Control of All Functions

APPLICATIONS

- HDD Based MP3 Players, PDA, GPS, PMP Products
- Other USB Based Handheld Products

DESCRIPTION

The LTC[®]3567 is a highly integrated power management and battery charger IC for Li-Ion/Polymer battery applications. It includes a high efficiency current limited switching PowerPath manager with automatic load prioritization, a battery charger, an ideal diode, and a high efficiency synchronous buck-boost switching regulator. Designed specifically for USB applications, the LTC3567's switching power manager automatically limits input current to a maximum of either 100mA or 500mA for USB or 1A for adapter-powered applications.

The LTC3567's switching input stage transmits nearly all of the 2.5W available from the USB port to the system load with minimal power wasted as heat. This feature allows the LTC3567 to provide more power to the application and eases thermal budgeting constraints in small spaces.

The synchronous buck-boost DC/DC can provide up to 1A output current.

The LTC3567 is available in a low profile 24-pin (4mm × 4mm × 0.75mm) QFN surface mount package.

LT, LT, LTC and LTM are registered trademarks of Linear Technology Corporation. PowerPath and Bat-Track are trademarks of Linear Technology Corporation. All other trademarks are the property of their respective owners. Protected by U.S. Patents including 6522118 and 6404251.

TYPICAL APPLICATION

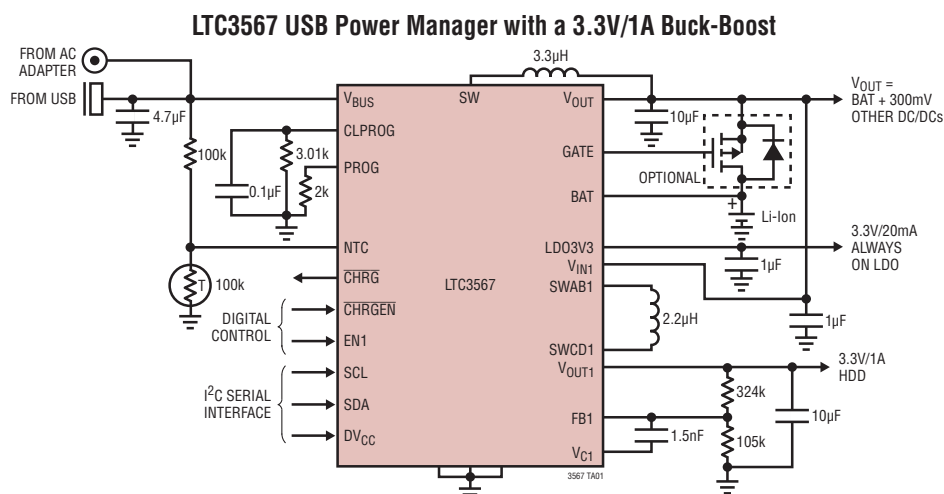

Switching Regulator Efficiency to System Load (P_{OUT}/P_{BUS})

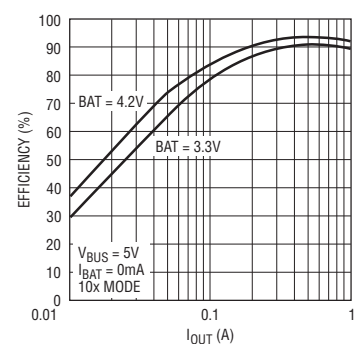

3567 TA01b

ABSOLUTE MAXIMUM RATINGS

(Note 1)

V_{BUS} (Transient) $t < 1\text{ms}$, Duty Cycle $< 1\%$	-0.3V to 7V
V_{BUS} (Static), V_{IN1} , BAT, NTC, CHRG, DV_{CC} , SCL, SDA, EN1, CHRGEN	-0.3V to 6V
FB1, V_{C1}	-0.3V to Lesser of 6V or $V_{IN1} + 0.3\text{V}$
I_{CLPROG}	3mA
I_{CHRG}	50mA
I_{PROG}	2mA
I_{LDO3V3}	30mA
I_{SW} , I_{BAT} , I_{VOUT}	2A
I_{VOUT1} , I_{SWAB1} , I_{SWCD1} ,	2.5A
Operating Temperature Range (Note 2)....	-40°C to 85°C
Junction Temperature (Note 3)	125°C
Storage Temperature Range.....	-65°C to 125°C

PIN CONFIGURATION

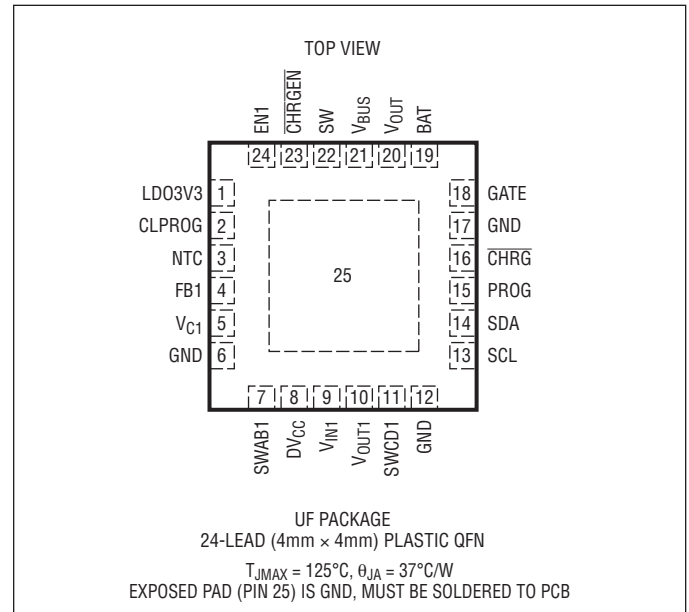

ORDER INFORMATION

LEAD FREE FINISH	TAPE AND REEL	PART MARKING	PACKAGE DESCRIPTION	TEMPERATURE RANGE
LTC3567EUF#PBF	LTC3567EUF#TRPBF	3567	24-Lead (4mm x 4mm) Plastic QFN	-40°C to 85°C

Consult LTC Marketing for parts specified with wider operating temperature ranges.

Consult LTC Marketing for information on non-standard lead based finish parts.

For more information on lead free part marking, go to: <http://www.linear.com/leadfree/>

For more information on tape and reel specifications, go to: <http://www.linear.com/tapeandreel/>

ELECTRICAL CHARACTERISTICS

The ● denotes the specifications which apply over the full operating temperature range, otherwise specifications are at $T_A = 25^\circ\text{C}$. $V_{BUS} = 5\text{V}$, $V_{IN1} = V_{OUT1} = 3.8\text{V}$, $V_{BAT} = 3.8\text{V}$, $DV_{CC} = 3.3\text{V}$, $R_{PROG} = 1\text{k}$, $R_{CLPROG} = 3.01\text{k}$, unless otherwise noted.

SYMBOL	PARAMETER	CONDITIONS	MIN	TYP	MAX	UNITS
PowerPath Switching Regulator						
V_{BUS}	Input Supply Voltage		4.35		5.5	V
I_{BUSLIM}	Total Input Current	1x Mode, $V_{OUT} = \text{BAT}$	● 87	95	100	mA
		5x Mode, $V_{OUT} = \text{BAT}$	● 436	460	500	mA
		10x Mode, $V_{OUT} = \text{BAT}$	● 800	860	1000	mA
		Suspend Mode, $V_{OUT} = \text{BAT}$	● 0.31	0.38	0.50	mA
I_{BUSQ}	V_{BUS} Quiescent Current	1x Mode, $I_{OUT} = 0\text{mA}$		7		mA
		5x Mode, $I_{OUT} = 0\text{mA}$		15		mA
		10x Mode, $I_{OUT} = 0\text{mA}$		15		mA
		Suspend Mode, $I_{OUT} = 0\text{mA}$		0.044		mA
h_{CLPROG} (Note 4)	Ratio of Measured V_{BUS} current to CLPROG Program Current	1x Mode		224		mA/mA
		5x Mode		1133		mA/mA
		10x Mode		2140		mA/mA
		Suspend Mode		11.3		mA/mA

3567f

ELECTRICAL CHARACTERISTICS The ● denotes the specifications which apply over the full operating temperature range, otherwise specifications are at $T_A = 25^\circ\text{C}$. $V_{\text{BUS}} = 5\text{V}$, $V_{\text{IN1}} = V_{\text{OUT1}} = 3.8\text{V}$, $V_{\text{BAT}} = 3.8\text{V}$, $DV_{\text{CC}} = 3.3\text{V}$, $R_{\text{PROG}} = 1\text{k}$, $R_{\text{CLPROG}} = 3.01\text{k}$, unless otherwise noted.

SYMBOL	PARAMETER	CONDITIONS	MIN	TYP	MAX	UNITS
I_{OUT} (POWERPATH)	V_{OUT} Current Available Before Loading BAT	1x Mode, BAT = 3.3V 5x Mode, BAT = 3.3V 10x Mode, BAT = 3.3V Suspend Mode		135 672 1251 0.32		mA mA mA mA
V_{CLPROG}	CLPROG Servo Voltage in Current Limit	1x, 5x, 10x Modes Suspend Mode		1.188 100		V mV
$V_{\text{UVLO_VBUS}}$	V_{BUS} Undervoltage Lockout	Rising Threshold Falling Threshold	3.95	4.30 4.00	4.35	V V
$V_{\text{UVLO_VBUS-VBAT}}$	V_{BUS} to BAT Differential Undervoltage Lockout	Rising Threshold Falling Threshold		200 50		mV mV
V_{OUT}	V_{OUT} Voltage	1x, 5x, 10x Modes, $0\text{V} < \text{BAT} < 4.2\text{V}$, $I_{\text{OUT}} = 0\text{mA}$, Battery Charger Off	3.4	BAT+0.3	4.7	V
		USB Suspend Mode, $I_{\text{OUT}} = 250\mu\text{A}$	4.5	4.6	4.7	V
f_{OSC}	Switching Frequency		● 1.8	2.25	2.7	MHz
$R_{\text{PMOS_POWERPATH}}$	PMOS On-Resistance			0.18		Ω
$R_{\text{NMOS_POWERPATH}}$	NMOS On-Resistance			0.30		Ω
$I_{\text{PEAK_POWERPATH}}$	Peak Switch Current Limit	1x, 5x Modes 10x Mode		2 3		A A

Battery Charger

V_{FLOAT}	BAT Regulated Output Voltage		● 4.179 4.165	4.200 4.200	4.221 4.235	V V
I_{CHG}	Constant Current Mode Charge Current	$R_{\text{PROG}} = 5\text{k}$	980 185	1022 204	1065 223	mA mA
I_{BAT}	Battery Drain Current	$V_{\text{BUS}} > V_{\text{UVLO}}$, Battery Charger Off, $I_{\text{OUT}} = 0\mu\text{A}$ $V_{\text{BUS}} = 0\text{V}$, $I_{\text{OUT}} = 0\mu\text{A}$ (Ideal Diode Mode)	2	3.5 27	5 38	μA μA
V_{PROG}	PROG Pin Servo Voltage			1.000		V
$V_{\text{PROG_TRIKL}}$	PROG Pin Servo Voltage in Trickle Charge	$V_{\text{BAT}} < V_{\text{TRIKL}}$		0.100		V
$V_{\text{C/10}}$	C/10 Threshold Voltage at PROG			100		mV
h_{PROG}	Ratio of I_{BAT} to PROG Pin Current			1022		mA/mA
I_{TRKL}	Trickle Charge Current	$\text{BAT} < V_{\text{TRKL}}$		100		mA
V_{TRKL}	Trickle Charge Threshold Voltage	BAT Rising	2.7	2.85	3.0	V
ΔV_{TRKL}	Trickle Charge Hysteresis Voltage			135		mV
V_{RECHRG}	Recharge Battery Threshold Voltage	Threshold Voltage Relative to V_{FLOAT}	-75	-100	-125	mV
t_{TERM}	Safety Timer Termination	Timer Starts When $\text{BAT} = V_{\text{FLOAT}}$	3.3	4	5	Hour
t_{BADBAT}	Bad Battery Termination Time	$\text{BAT} < V_{\text{TRKL}}$	0.42	0.5	0.63	Hour
$h_{\text{C/10}}$	End of Charge Indication Current Ratio	(Note 5)	0.088	0.1	0.112	mA/mA
V_{CHRG}	$\overline{\text{CHRG}}$ Pin Output Low Voltage	$I_{\overline{\text{CHRG}}} = 5\text{mA}$		65	100	mV
I_{CHRG}	$\overline{\text{CHRG}}$ Pin Leakage Current	$V_{\overline{\text{CHRG}}} = 5\text{V}$			1	μA

ELECTRICAL CHARACTERISTICS

The ● denotes the specifications which apply over the full operating temperature range, otherwise specifications are at $T_A = 25^\circ\text{C}$. $V_{\text{BUS}} = 5\text{V}$, $V_{\text{IN1}} = V_{\text{OUT1}} = 3.8\text{V}$, $V_{\text{BAT}} = 3.8\text{V}$, $DV_{\text{CC}} = 3.3\text{V}$, $R_{\text{PROG}} = 1\text{k}$, $R_{\text{CLPROG}} = 3.01\text{k}$, unless otherwise noted.

SYMBOL	PARAMETER	CONDITIONS	MIN	TYP	MAX	UNITS
$R_{\text{ON_CHG}}$	Battery Charger Power FET On Resistance (Between V_{OUT} and BAT)			0.18		Ω
T_{LIM}	Junction Temperature in Constant Temperature Mode			110		$^\circ\text{C}$
NTC						
V_{COLD}	Cold Temperature Fault Threshold Voltage	Rising Threshold Hysteresis	75.0	76.5 1.5	78.0	$\%V_{\text{BUS}}$ $\%V_{\text{BUS}}$
V_{HOT}	Hot Temperature Fault Threshold Voltage	Falling Threshold Hysteresis	33.4	34.9 1.5	36.4	$\%V_{\text{BUS}}$ $\%V_{\text{BUS}}$
V_{DIS}	NTC Disable Threshold Voltage	Falling Threshold Hysteresis	0.7	1.7 50	2.7	$\%V_{\text{BUS}}$ mV
I_{NTC}	NTC Leakage Current	$V_{\text{NTC}} = V_{\text{BUS}} = 5\text{V}$	-50		50	nA
Ideal Diode						
V_{FWD}	Forward Voltage	$V_{\text{BUS}} = 0\text{V}$, $I_{\text{OUT}} = 10\text{mA}$ $I_{\text{OUT}} = 10\text{mA}$		2 15		mV mV
R_{DROPOUT}	Internal Diode On-Resistance, Dropout	$V_{\text{BUS}} = 0\text{V}$		0.18		Ω
$I_{\text{MAX_DIODE}}$	Internal Diode Current Limit		1.6			A
Always On 3.3V Supply						
V_{LD03V3}	Regulated Output Voltage	$0\text{mA} < I_{\text{LD03V3}} < 25\text{mA}$	3.1	3.3	3.5	V
$R_{\text{CL_LD03V3}}$	Closed-Loop Output Resistance			4		Ω
$R_{\text{OL_LD03V3}}$	Dropout Output Resistance			23		Ω
Logic (CHRGEN, EN1)						
V_{IL}	Logic Low Input Voltage				0.4	V
V_{IH}	Logic High Input Voltage		1.2			V
$I_{\text{PD_EN1}}$	EN1 Pull-Down Current			1.6		μA
$I_{\text{PD_CHRGEN}}$	CHRGEN Pull-Down Current			1.6	10	μA
I²C Port (Note 6)						
DV_{CC}	Input Supply Voltage		1.6		5.5	V
I_{DVCC}	DV_{CC} Current	SCL/SDA = 0kHz		0.3	1	μA
$V_{\text{DVCC_UVLO}}$	DV_{CC} UVLO			1.0		V
ADDRESS	I ² C Address			0001001[0]		
$V_{\text{IH, SDA, SCL}}$	Input High Voltage		70			$\%DV_{\text{CC}}$
$V_{\text{IL, SDA, SCL}}$	Input Low Voltage				30	$\%DV_{\text{CC}}$
$I_{\text{IH, IIL SDA, SCL}}$	Input High/Low Current		-1	0	1	μA
V_{OLSDA}	SDA Output Low Voltage	$I_{\text{SDA}} = 3\text{mA}$			0.4	V
f_{SCL}	Clock Operating Frequency				400	kHz
t_{BUF}	Bus Free Time Between Stop and Start Condition		1.3			μs
$t_{\text{HD_STA}}$	Hold Time After (Repeated) Start Condition		0.6			μs
$t_{\text{SU_STA}}$	Repeated Start Condition Setup Time		0.6			μs

ELECTRICAL CHARACTERISTICS

The ● denotes the specifications which apply over the full operating temperature range, otherwise specifications are at $T_A = 25^\circ\text{C}$. $V_{\text{BUS}} = 5\text{V}$, $V_{\text{IN1}} = V_{\text{OUT1}} = 3.8\text{V}$, $V_{\text{BAT}} = 3.8\text{V}$, $DV_{\text{CC}} = 3.3\text{V}$, $R_{\text{PROG}} = 1\text{k}$, $R_{\text{CLPROG}} = 3.01\text{k}$, unless otherwise noted.

SYMBOL	PARAMETER	CONDITIONS	MIN	TYP	MAX	UNITS
$t_{\text{SU_STO}}$	Stop Condition Setup Time		0.6			μs
$t_{\text{HD_DAT (O)}}$	Data Hold Time Output		0		900	ns
$t_{\text{HD_DAT (I)}}$	Data Hold Time Input		0			ns
$t_{\text{SU_DAT}}$	Data Setup Time		100			ns
t_{LOW}	SCL Clock Low Period		1.3			μs
t_{HIGH}	SCL Clock High Period		0.6			μs
t_f	Clock/Data Fall Time	$C_B =$ Capacitance of One BUS Line (pF)	$20+0.1 \cdot C_B$		300	ns
t_r	Clock/Data Rise Time	$C_B =$ Capacitance of One BUS Line (pF)	$20+0.1 \cdot C_B$		300	ns
t_{SP}	Input Spike Suppression Pulse Width				50	ns

Buck-Boost Regulator

V_{IN1}	Input Supply Voltage		2.7		5.5	V	
V_{OUT1UVLO}	$V_{\text{OUT1UVLO}} - V_{\text{OUT1}}$ Falling $V_{\text{OUT1UVLO}} - V_{\text{OUT1}}$ Rising	V_{IN1} Connected to V_{OUT1} Through Low Impedance. Switching Regulator is Disabled in UVLO	2.5	2.6 2.8	2.9	V V	
f_{OSC}	Oscillator Frequency	●	1.8	2.25	2.7	MHz	
I_{VIN1}	Input Current	PWM Mode, $I_{\text{OUT1}} = 0\mu\text{A}$ Burst Mode® Operation, $I_{\text{OUT1}} = 0\mu\text{A}$ Shutdown		220 13 0	400 20 1	μA μA μA	
$V_{\text{OUT1(LOW)}}$	Minimum Regulated Output Voltage	For Burst Mode Operation or Synchronous PWM Operation		2.65	2.75	V	
$V_{\text{OUT1(HIGH)}}$	Maximum Regulated Output Voltage		5.50	5.60		V	
I_{LIMF1}	Forward Current Limit (Switch A)	PWM Mode	●	2	2.5	3	A
$I_{\text{PEAK1(BURST)}}$	Forward Burst Current Limit (Switch A)	Burst Mode Operation	●	200	275	350	mA
$I_{\text{ZERO1(BURST)}}$	Reverse Burst Current Limit (Switch D)	Burst Mode Operation	●	-30	0	30	mA
$I_{\text{MAX1(BURST)}}$	Maximum Deliverable Output Current in Burst Mode Operation	$2.7\text{V} \leq V_{\text{IN1}} \leq 5.5\text{V}$, $2.75\text{V} \leq V_{\text{OUT1}} \leq 5.5\text{V}$ (Note 6)		50			mA
V_{FBHIGH1}	Maximum Servo Voltage	Full Scale (1,1,1,1)	●	0.780	0.800	0.820	V
V_{FBLow1}	Minimum Servo Voltage	Zero Scale (0,0,0,0)	●	0.405	0.425	0.445	V
V_{LSB1}	V_{FB1} Servo Voltage Step Size			25			mV
I_{FB1}	FB1 Input Current	$V_{\text{FB1}} = 0.8\text{V}$		-50		50	nA
$R_{\text{DS(ON)P}}$	PMOS $R_{\text{DS(ON)}}$	Switches A, D			0.22		Ω
$R_{\text{DS(ON)N}}$	NMOS $R_{\text{DS(ON)}}$	Switches B, C			0.17		Ω
$I_{\text{LEAK(P)}}$	PMOS Switch Leakage	Switches A, D		-1		1	μA
$I_{\text{LEAK(N)}}$	NMOS Switch Leakage	Switches B, C		-1		1	μA
R_{VOUT1}	V_{OUT1} Pull-Down in Shutdown			10			k Ω
$D_{\text{BUCK(MAX)}}$	Maximum Buck Duty Cycle	PWM Mode	●	100			%
$D_{\text{BOOST(MAX)}}$	Maximum Boost Duty Cycle	PWM Mode			75		%
t_{SS1}	Soft-Start Time			0.5			ms

Burst Mode is a registered trademark of Linear Technology Corporation.

ELECTRICAL CHARACTERISTICS

Note 1: Stresses beyond those listed under Absolute Maximum Ratings may cause permanent damage to the device. Exposure to any Absolute Maximum Rating condition for extended periods may affect device reliability and lifetime.

Note 2: The LTC3567E is guaranteed to meet performance specifications from 0°C to 85°C. Specifications over the -40°C to 85°C operating temperature range are assured by design, characterization and correlation with statistical process controls.

Note 3: The LTC3567 includes overtemperature protection that is intended to protect the device during momentary overload conditions. Junction

temperatures will exceed 125°C when overtemperature protection is active. Continuous operation above the specified maximum operating junction temperature may impair device reliability.

Note 4: Total Input current is the sum of quiescent current, I_{VBUSQ} , and measured current given by:

$$V_{CLPROG/RCLPROG} \cdot (h_{CLPROG} + 1)$$

Note 5: $h_{C/10}$ is expressed as a fraction of measured full charge current with indicated PROG resistor.

Note 6: Guaranteed by design.

TYPICAL PERFORMANCE CHARACTERISTICS $T_A = 25^\circ\text{C}$ unless otherwise noted.

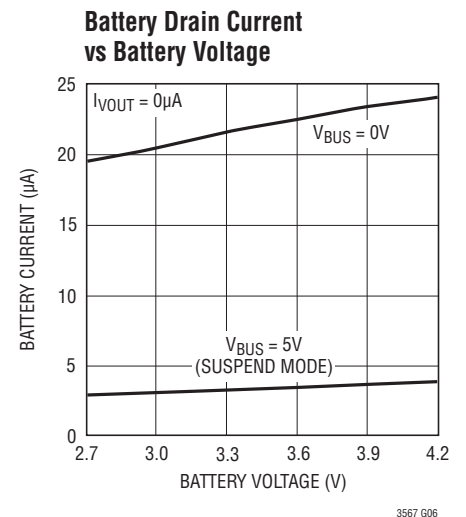
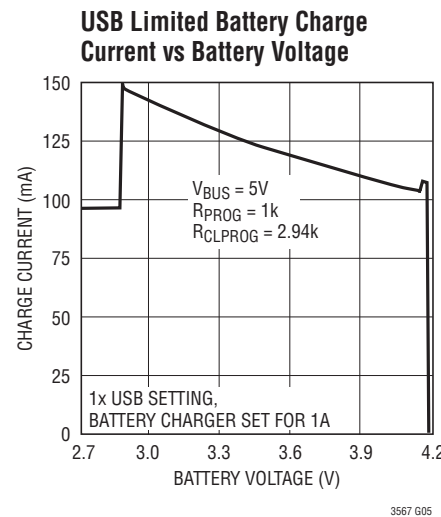
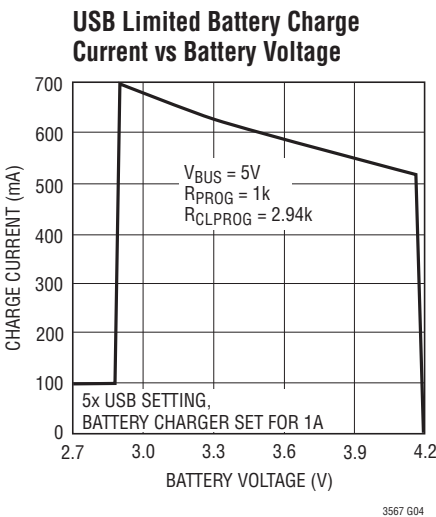
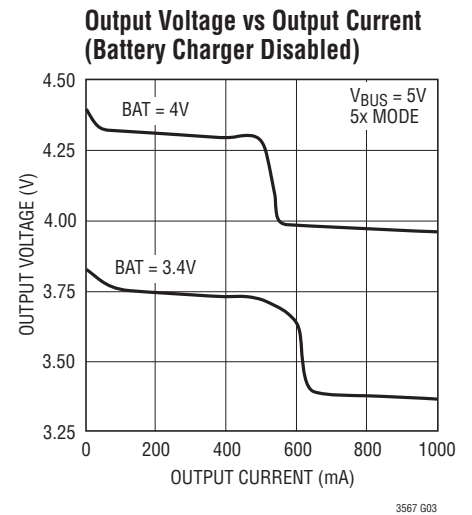
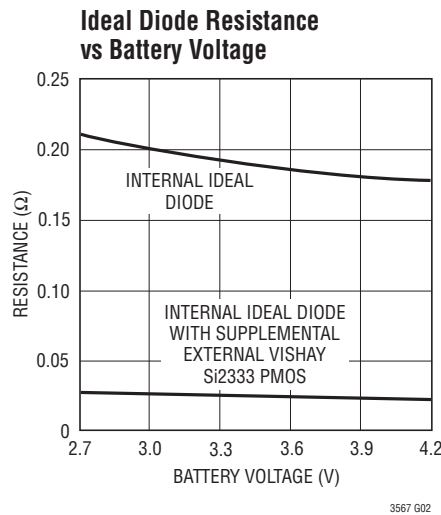
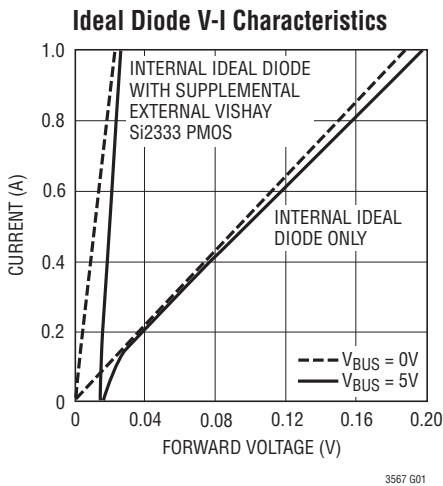

TYPICAL PERFORMANCE CHARACTERISTICS $T_A = 25^\circ\text{C}$ unless otherwise noted.

PowerPath Switching Regulator Efficiency vs Output Current

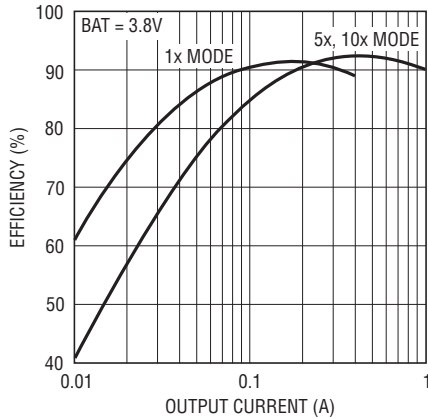

3567 G07

Battery Charging Efficiency vs Battery Voltage with No External Load (P_{BAT}/P_{BUS})

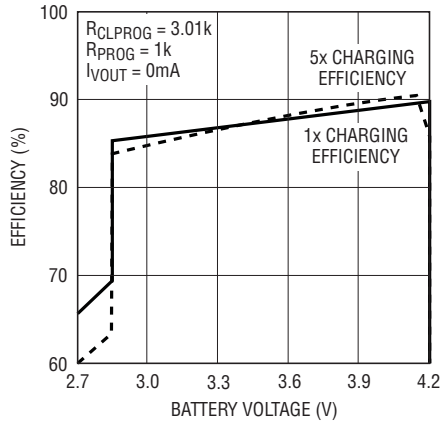

3567 G08

V_{BUS} Current vs V_{BUS} Voltage (Suspend)

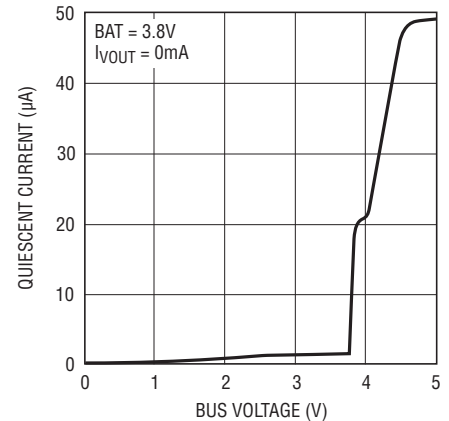

3567 G09

Output Voltage vs Load Current in Suspend

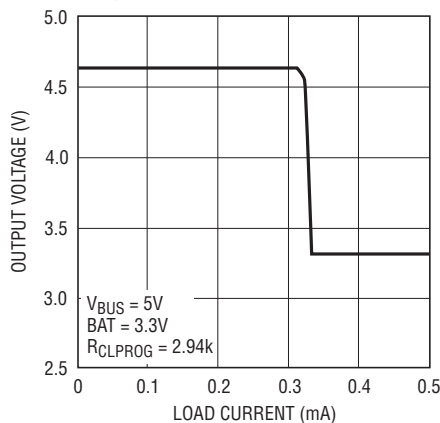

3567 G10

V_{BUS} Current vs Load Current in Suspend

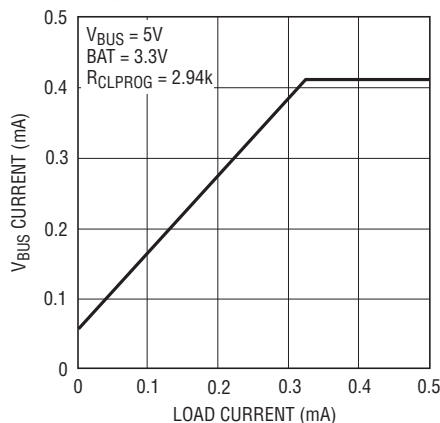

3567 G11

3.3V LDO Output Voltage vs Load Current, $V_{BUS} = 0V$

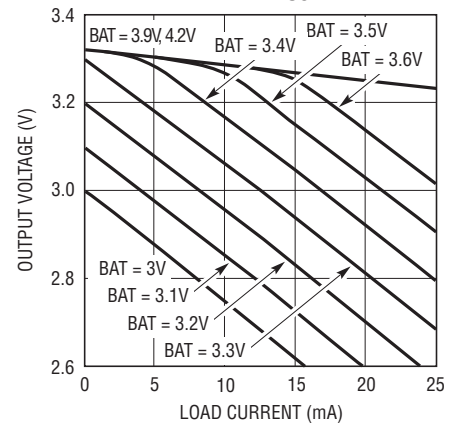

3567 G12

Battery Charge Current vs Temperature

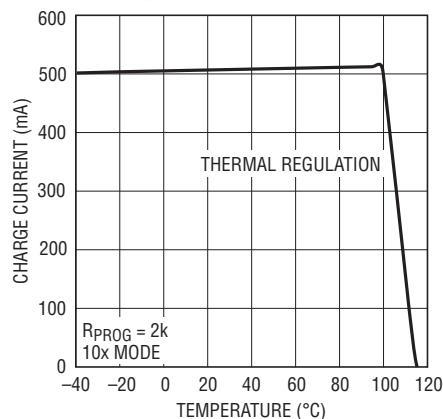

3567 G13

Battery Charger Float Voltage vs Temperature

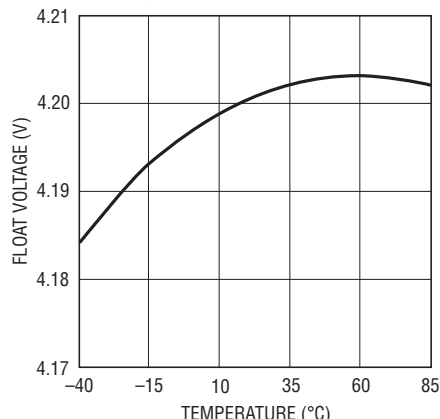

3567 G14

Low-Battery (Instant-On) Output Voltage vs Temperature

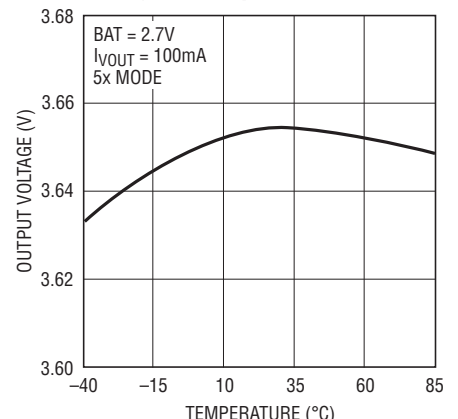

3567 G15

TYPICAL PERFORMANCE CHARACTERISTICS $T_A = 25^\circ\text{C}$ unless otherwise noted.

Oscillator Frequency vs Temperature

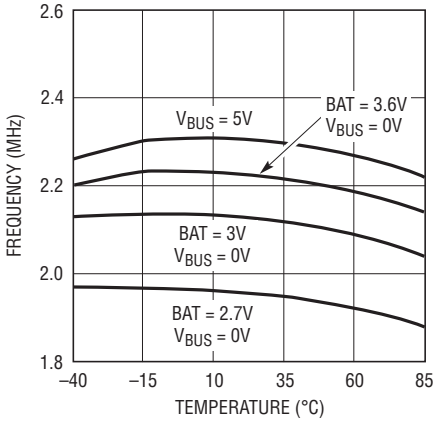

3567 G16

V_{BUS} Quiescent Current vs Temperature

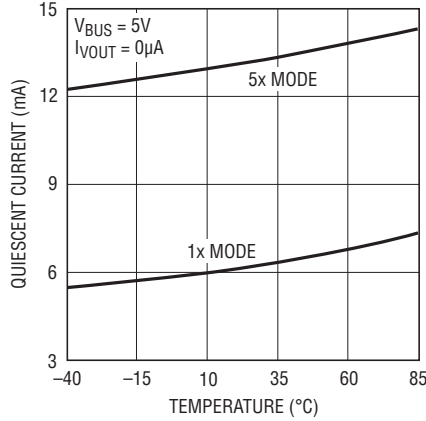

3567 G17

V_{BUS} Quiescent Current in Suspend vs Temperature

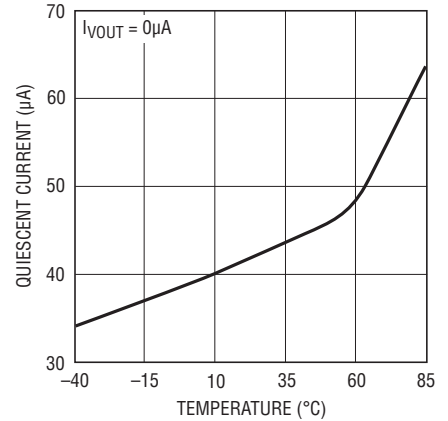

3567 G18

CHRG Pin Current vs Voltage (Pull-Down State)

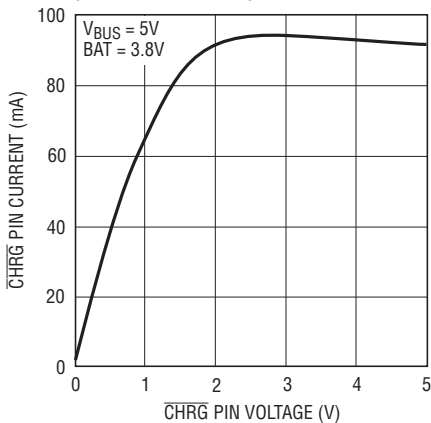

3567 G19

3.3V LDO Step Response (5mA to 15mA)

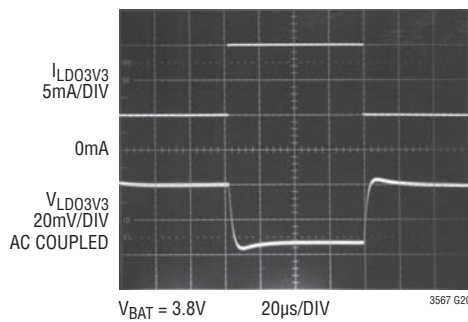

3567 G20

Battery Drain Current vs Temperature

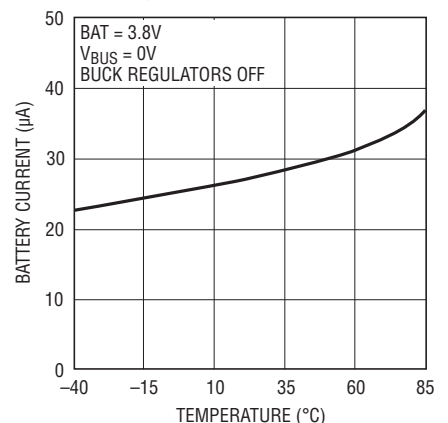

3567 G21

R_{DS(ON)} for Buck-Boost Regulator Power Switches vs Temperature

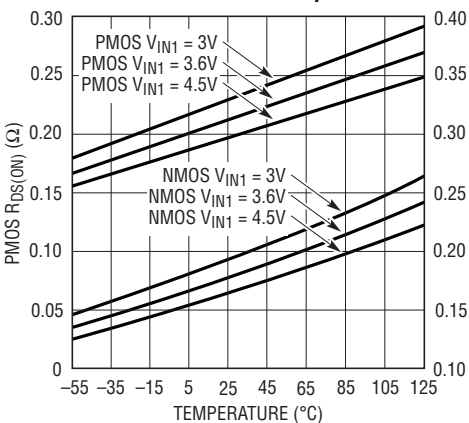

3567 G22

Buck-Boost Regulator Current Limit vs Temperature

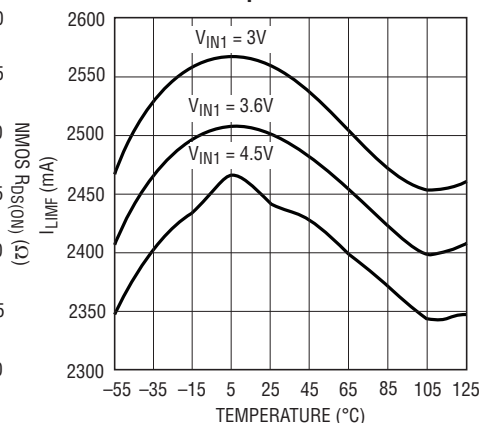

3567 G23

Buck-Boost Regulator Burst Mode Operation Quiescent Current

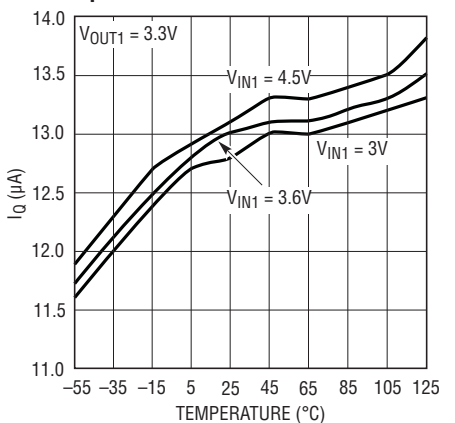

3567 G24

TYPICAL PERFORMANCE CHARACTERISTICS $T_A = 25^\circ\text{C}$ unless otherwise noted.

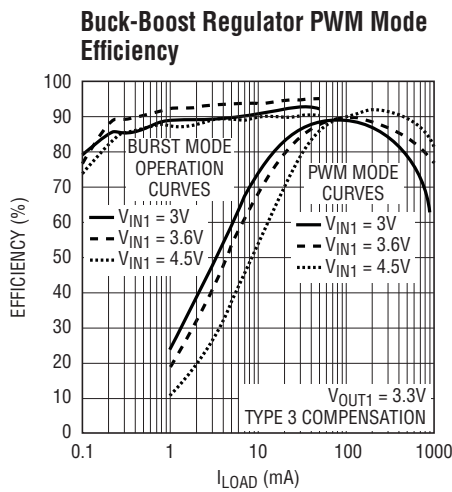

3567 G25

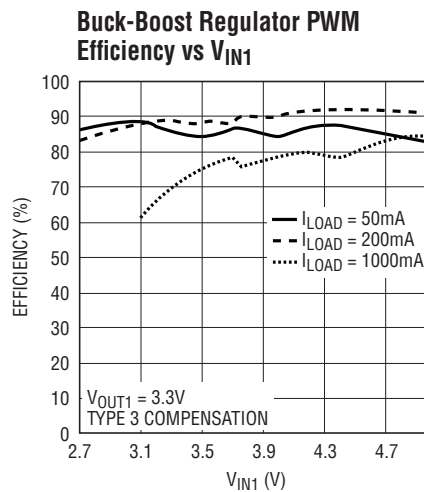

3567 G26

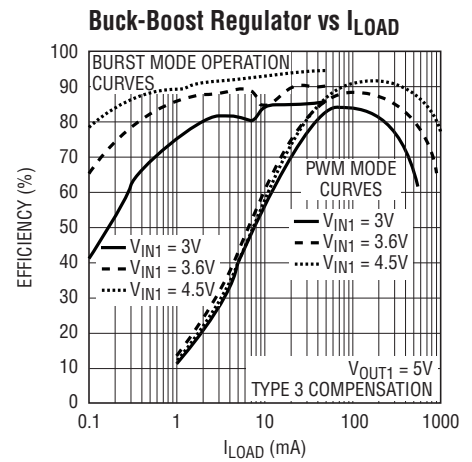

3567 G27

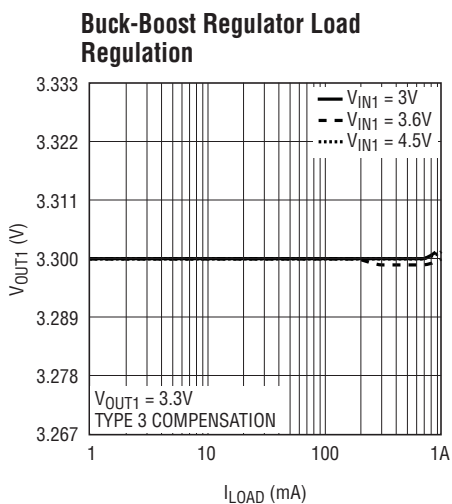

3567 G28

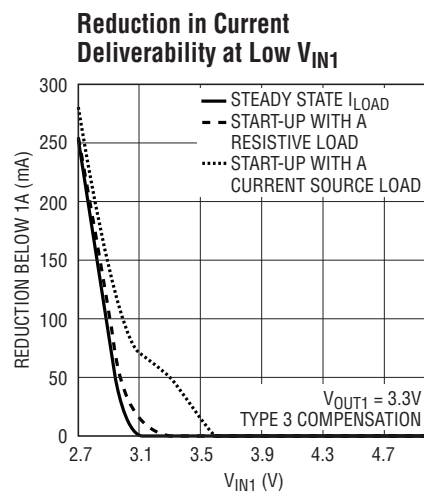

3567 G29

Buck-Boost Regulator Load Step, 0mA to 300mA

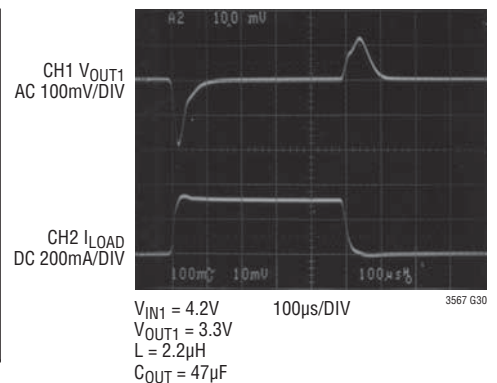

3567 G30

PIN FUNCTIONS

LD03V3 (Pin 1): 3.3V LDO Output Pin. This pin provides a regulated always-on, 3.3V supply voltage. LD03V3 gets its power from V_{OUT} . It may be used for light loads such as a watchdog microprocessor or real time clock. A $1\mu\text{F}$ capacitor is required from LD03V3 to ground. If the LD03V3 output is not used it should be disabled by connecting it to V_{OUT} .

CLPROG (Pin 2): USB Current Limit Program and Monitor Pin. A resistor from CLPROG to ground determines the upper limit of the current drawn from the V_{BUS} pin. A fraction of the V_{BUS} current is sent to the CLPROG pin

when the synchronous switch of the PowerPath switching regulator is on. The switching regulator delivers power until the CLPROG pin reaches 1.188V. Several V_{BUS} current limit settings are available via user input which will typically correspond to the 500mA and the 100mA USB specifications. A multilayer ceramic averaging capacitor or R-C network is required at CLPROG for filtering.

NTC (Pin 3): Input to the Thermistor Monitoring Circuits. The NTC pin connects to a battery's thermistor to determine if the battery is too hot or too cold to charge. If the battery's temperature is out of range, charging is paused

3567f

PIN FUNCTIONS

until it re-enters the valid range. A low drift bias resistor is required from V_{BUS} to NTC and a thermistor is required from NTC to ground. If the NTC function is not desired, the NTC pin should be grounded.

FB1 (Pin 4): Feedback Input for the (Buck-Boost) Switching Regulator. When the regulator's control loop is complete, this pin serves to 1 of 16 possible set-points based on the commanded value from the I²C serial port. See Table 4.

V_{C1} (Pin 5): Output of the Error Amplifier and Voltage Compensation Node for the (Buck-Boost) Switching Regulator. External Type I or Type III compensation (to FB1) connects to this pin. See Applications Section for selecting buck-boost loop compensation components.

GND (Pin 6, 12): Power GND Pins for the buck-boost.

SWAB1 (Pin 7): Switch Node for the (Buck-Boost) Switching Regulator. Connected to internal power switches A and B. External inductor connects between this node and SWCD1.

DV_{CC} (Pin 8): Logic Supply for the I²C Serial Port.

V_{IN1} (Pin 9): Power Input for the (Buck-Boost) Switching Regulator. This pin will generally be connected to V_{OUT} (Pin 20). A 1 μ F (min) MLCC capacitor is recommended on this pin.

V_{OUT1} (Pin 10): Regulated Output Voltage for the (Buck-Boost) Switching Regulator.

SWCD1 (Pin 11): Switch Node for the (Buck-Boost) Switching Regulator. Connected to internal power switches C and D. External inductor connects between this node and SWAB1.

SCL (Pin 13): Clock Input Pin for the I²C Serial Port. The I²C logic levels are scaled with respect to DV_{CC}.

SDA (Pin 14): Data Input Pin for the I²C Serial Port. The I²C logic levels are scaled with respect to DV_{CC}.

PROG (Pin 15): Charge Current Program and Charge Current Monitor Pin. Connecting a resistor from PROG to ground programs the charge current. If sufficient input power is available in constant-current mode, this pin serves to 1V. The voltage on this pin always represents the actual charge current.

CHRG (Pin 16): Open-Drain Charge Status Output. The $\overline{\text{CHRG}}$ pin indicates the status of the battery charger. Four possible states are represented by $\overline{\text{CHRG}}$: charging, not charging, unresponsive battery and battery temperature out of range. $\overline{\text{CHRG}}$ is modulated at 35kHz and switches between a low and high duty cycle for easy recognition by either humans or microprocessors. See Table 1. CHRG requires a pull-up resistor and/or LED to provide indication.

GND (Pin 17): GND pin for USB Power Manager.

GATE (Pin 18): Analog Output. This pin controls the gate of an optional external P-channel MOSFET transistor used to supplement the ideal diode between V_{OUT} and BAT. The external ideal diode operates in parallel with the internal ideal diode. The source of the P-channel MOSFET should be connected to V_{OUT} and the drain should be connected to BAT. If the external ideal diode FET is not used, GATE should be left floating.

BAT (Pin 19): Single Cell Li-Ion Battery Pin. Depending on available V_{BUS} power, a Li-Ion battery on BAT will either deliver power to V_{OUT} through the ideal diode or be charged from V_{OUT} via the battery charger.

V_{OUT} (Pin 20): Output Voltage of the Switching Power-Path Controller and Input Voltage of the Battery Charger. The majority of the portable product should be powered from V_{OUT} . The LTC3567 will partition the available power between the external load on V_{OUT} and the internal battery charger. Priority is given to the external load and any extra power is used to charge the battery. An ideal diode from BAT to V_{OUT} ensures that V_{OUT} is powered even if the load exceeds the allotted power from V_{BUS} or if the V_{BUS} power source is removed. V_{OUT} should be bypassed with a low impedance ceramic capacitor.

V_{BUS} (Pin 21): Primary Input Power Pin. This pin delivers power to V_{OUT} via the SW pin by drawing controlled current from a DC source such as a USB port or wall adapter.

SW (Pin 22): Power Transmission Pin for the USB PowerPath. The SW pin delivers power from V_{BUS} to V_{OUT} via the step-down switching regulator. A 3.3 μ H inductor should be connected from SW to V_{OUT} .

PIN FUNCTIONS

CHRGEN (Pin 23): Logic Input. This logic input pin independently enables the battery charger. Active low. Has a $1.6\mu\text{A}$ internal pull-down current source. This pin is logically ORed with its corresponding bit in the I²C serial port.

EN1 (Pin 24): Logic Input. This logic input pin independently enables the buck-boost switching regulator. Active high. Has a $1.6\mu\text{A}$ internal pull-down current source. This

pin is logically ORed with its corresponding bit in the I²C serial port.

Exposed Pad (Pin 25): Ground. Buck-Boost logic and USB power manager ground connections. The Exposed Pad should be connected to a continuous ground plane on the printed circuit board directly under the LTC3567.

BLOCK DIAGRAM

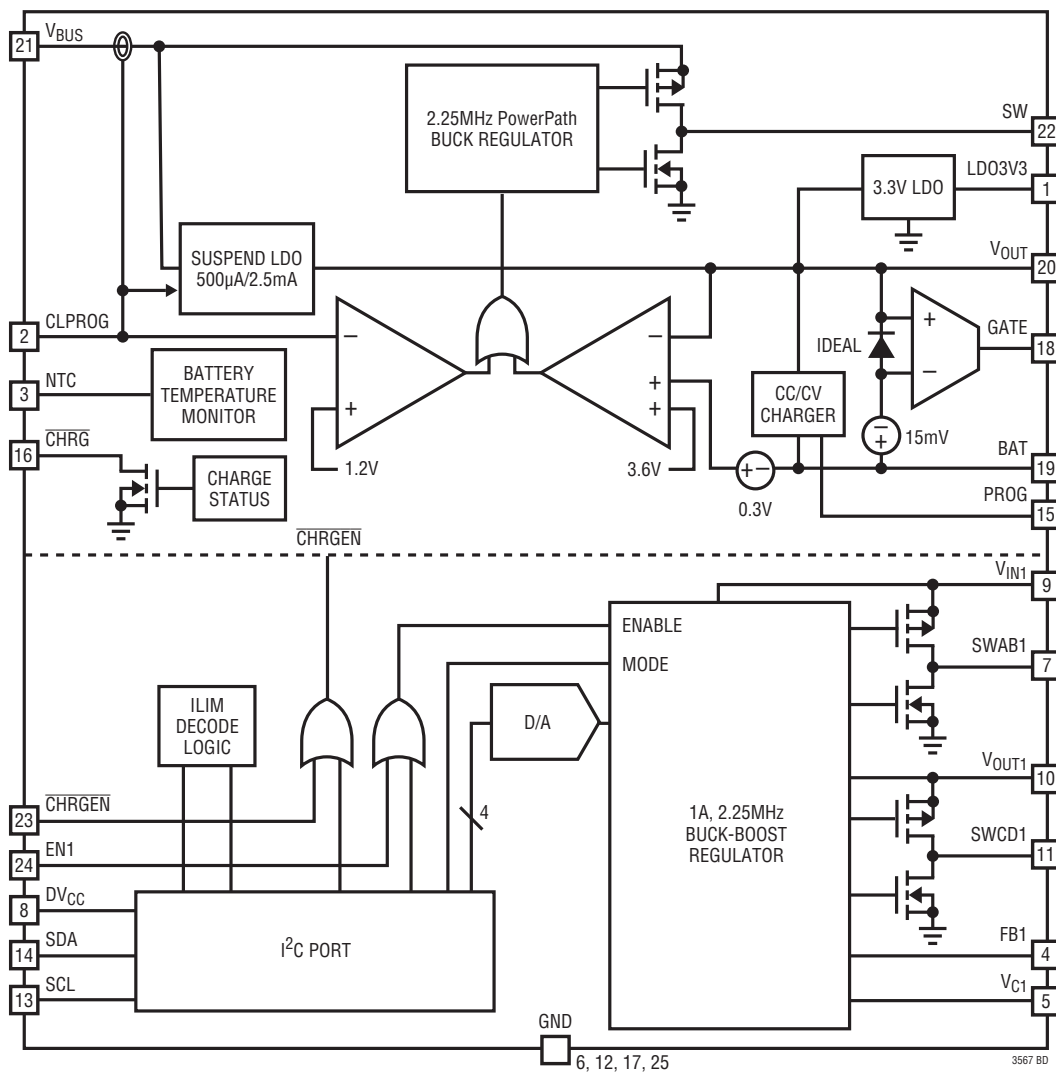

TIMING DIAGRAM

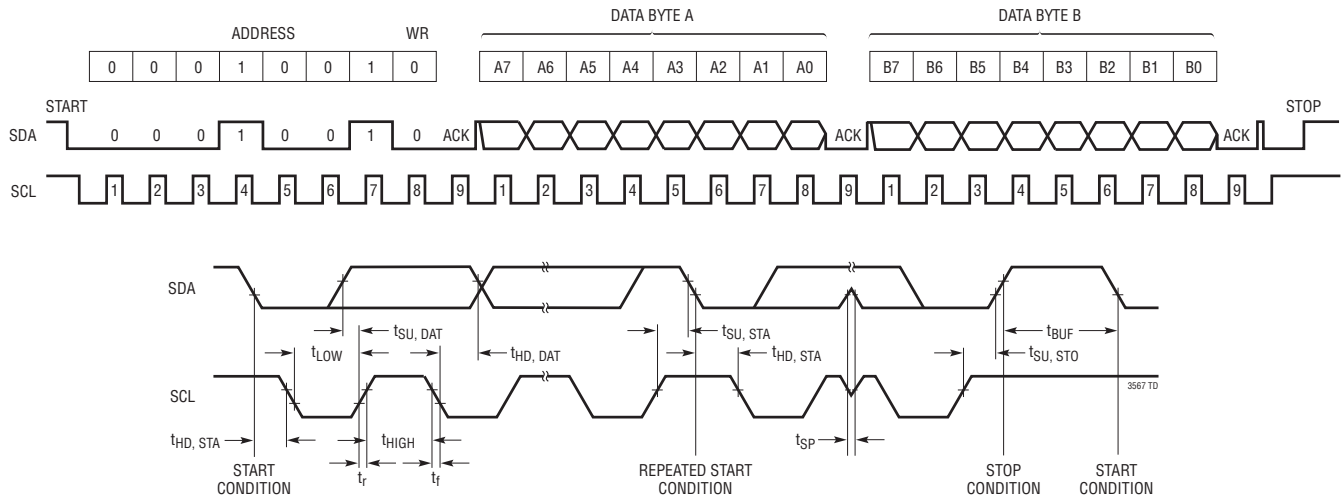

OPERATION

Introduction

The LTC3567 is a highly integrated power management IC which includes a high efficiency switch mode PowerPath controller, a battery charger, an ideal diode, an always-on LDO and a 1A buck-boost switching regulator. The entire chip is controllable via an I²C serial port.

Designed specifically for USB applications, the PowerPath controller incorporates a precision average input current step-down switching regulator to make maximum use of the allowable USB power. Because power is conserved, the LTC3567 allows the load current on V_{OUT} to exceed the current drawn by the USB port without exceeding the USB load specifications.

The PowerPath switching regulator and battery charger communicate to ensure that the input current never violates the USB specifications.

The ideal diode from BAT to V_{OUT} guarantees that ample power is always available to V_{OUT} even if there is insufficient or absent power at V_{BUS}.

An “always-on” LDO provides a regulated 3.3V from available power at V_{OUT}. Drawing very little quiescent current, this LDO will be on at all times and can be used to supply up to 25mA.

The LTC3567 also has a general purpose buck-boost switching regulator, which can be independently enabled via direct digital control or the I²C serial port. Along with constant frequency PWM mode, the buck-boost regulator has a low power burst-only mode setting for significantly reduced quiescent current under light load conditions.

High Efficiency Switching PowerPath Controller

Whenever V_{BUS} is available and the PowerPath switching regulator is enabled, power is delivered from V_{BUS} to V_{OUT} via SW. V_{OUT} drives both the external load (including the buck-boost regulator) and the battery charger.

If the combined load does not exceed the PowerPath switching regulator’s programmed input current limit, V_{OUT} will track 0.3V above the battery (Bat-Track). By keeping the voltage across the battery charger low, efficiency is optimized because power lost to the linear battery charger is minimized. Power available to the external load is therefore optimized.

If the combined load at V_{OUT} is large enough to cause the switching power supply to reach the programmed input current limit, the battery charger will reduce its charge current by the amount necessary to enable the external load to be satisfied. Even if the battery charge current is

OPERATION

set to exceed the allowable USB current, the USB specification will not be violated. The switching regulator will limit the average input current so that the USB specification is never violated. Furthermore, load current at V_{OUT} will always be prioritized and only remaining available power will be used to charge the battery.

If the voltage at BAT is below 3.3V, or the battery is not present and the load requirement does not cause the switching regulator to exceed the USB specification, V_{OUT} will regulate at 3.6V, thereby providing “Instant-On” operation. If the load exceeds the available power, V_{OUT} will drop to a voltage between 3.6V and the battery voltage. If there is no battery present when the load exceeds the available USB power, V_{OUT} can drop toward ground.

The power delivered from V_{BUS} to V_{OUT} is controlled by a 2.25MHz constant-frequency step-down switching regulator. To meet the USB maximum load specification, the switching regulator includes a control loop which ensures that the average input current is below the level programmed at CLPROG.

The current at CLPROG is a fraction (h_{CLPROG}^{-1}) of the V_{BUS} current. When a programming resistor and an averaging capacitor are connected from CLPROG to GND, the voltage on CLPROG represents the average input current of the switching regulator. When the input current approaches the programmed limit, CLPROG reaches V_{CLPROG} , 1.188V and power out is held constant. The input current is programmed by the B1 and B0 bits of the I²C serial port. It can be configured to limit average input current to one of several possible settings as well as be deactivated (USB suspend). The input current limit will be set by the V_{CLPROG} servo voltage and the resistor on CLPROG according to the following expression:

$$I_{VBUS} = I_{BUSQ} + \frac{V_{CLPROG}}{R_{CLPROG}} \cdot (h_{CLPROG} + 1)$$

Figure 1 shows the range of possible voltages at V_{OUT} as a function of battery voltage.

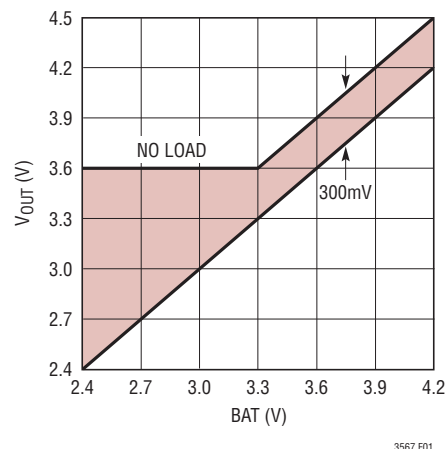

Figure 1. V_{OUT} vs BAT

Ideal Diode from BAT to V_{OUT}

The LTC3567 has an internal ideal diode as well as a controller for an optional external ideal diode. The ideal diode controller is always on and will respond quickly whenever V_{OUT} drops below BAT.

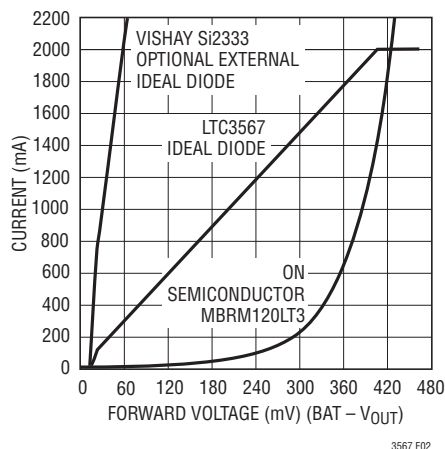

Figure 2. Ideal Diode Operation

If the load current increases beyond the power allowed from the switching regulator, additional power will be pulled from the battery via the internal ideal diode. Furthermore, if power to V_{BUS} (USB or wall power) is removed, then all of the application power will be provided by the battery via the ideal diode. The transition from input power to battery power at V_{OUT} will be quick enough to allow only the 10 μ F capacitor to keep V_{OUT} from drooping. The ideal diode consists of a precision amplifier that enables a large on-

OPERATION

chip P-channel MOSFET transistor whenever the voltage at V_{OUT} is approximately 15mV (V_{FWD}) below the voltage at BAT. The resistance of the internal ideal diode is approximately 180m Ω . If this is sufficient for the application, then no external components are necessary. However, if more conductance is needed, an external P-channel MOSFET transistor can be added from BAT to V_{OUT} .

When an external P-channel MOSFET transistor is present, the GATE pin of the LTC3567 drives its gate for automatic ideal diode control. The source of the external P-channel MOSFET should be connected to V_{OUT} and the drain should be connected to BAT. Capable of driving a 1nF load, the GATE pin can control an external P-channel MOSFET transistor having an on-resistance of 40m Ω or lower.

Suspend LDO

If the LTC3567 is configured for USB suspend mode, the switching regulator is disabled and the suspend LDO provides power to the V_{OUT} pin (presuming there is power available to V_{BUS}). This LDO will prevent the battery from running down when the portable product has access to a suspended USB port. Regulating at 4.6V, this LDO only becomes active when the switching converter is disabled (suspended). To remain compliant with the USB specification, the input to the LDO is current limited so that it will

not exceed the 500 μ A low power suspend specification. If the load on V_{OUT} exceeds the suspend current limit, the additional current will come from the battery via the ideal diode.

3.3V Always-On Supply

The LTC3567 includes a low quiescent current low drop-out regulator that is always powered. This LDO can be used to provide power to a system pushbutton controller, standby microcontroller or real time clock. Designed to deliver up to 25mA, the always-on LDO requires at least a 1 μ F low impedance ceramic bypass capacitor for compensation. The LDO is powered from V_{OUT} , and therefore will enter dropout at loads less than 25mA as V_{OUT} falls near 3.3V. If the LDO3V3 output is not used, it should be disabled by connecting it to V_{OUT} .

V_{BUS} Undervoltage Lockout (UVLO)

An internal undervoltage lockout circuit monitors V_{BUS} and keeps the PowerPath switching regulator off until V_{BUS} rises above 4.30V and is at least 200mV above the battery voltage. Hysteresis on the UVLO turns off the regulator if V_{BUS} drops below 4.00V or to within 50mV of BAT. When this happens, system power at V_{OUT} will be drawn from the battery via the ideal diode.

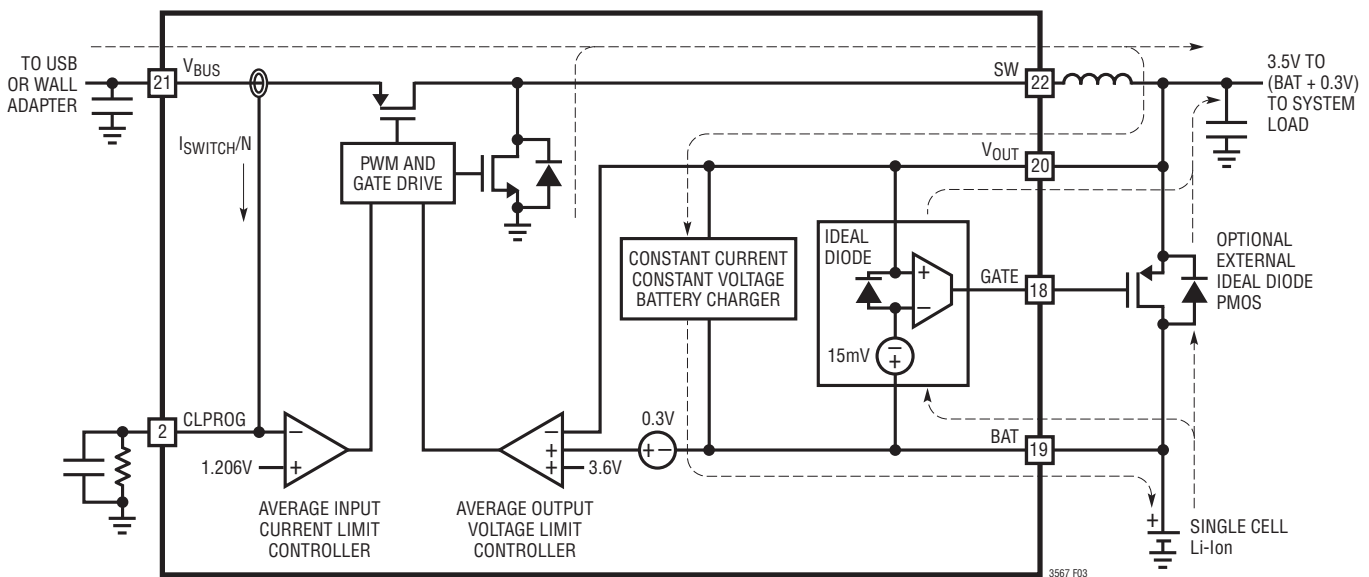

Figure 3. PowerPath Block Diagram

OPERATION

Battery Charger

The LTC3567 includes a constant-current/constant-voltage battery charger with automatic recharge, automatic termination by safety timer, low voltage trickle charging, bad cell detection and thermistor sensor input for out-of-temperature charge pausing.

Battery Preconditioning

When a battery charge cycle begins, the battery charger first determines if the battery is deeply discharged. If the battery voltage is below V_{TRKL} , typically 2.85V, an automatic trickle charge feature sets the battery charge current to 10% of the programmed value. If the low voltage persists for more than 1/2 hour, the battery charger automatically terminates and indicates via the \overline{CHRG} pin that the battery was unresponsive.

Once the battery voltage is above 2.85V, the battery charger begins charging in full power constant-current mode. The current delivered to the battery will try to reach $1022V/R_{PROG}$. Depending on available input power and external load conditions, the battery charger may or may not be able to charge at the full programmed rate. The external load will always be prioritized over the battery charge current. The USB current limit programming will always be observed and only additional power will be available to charge the battery. When system loads are light, battery charge current will be maximized.

Charge Termination

The battery charger has a built-in safety timer. When the voltage on the battery reaches the pre-programmed float voltage of 4.200V, the battery charger will regulate the battery voltage and the charge current will decrease naturally. Once the battery charger detects that the battery has reached 4.200V, the four hour safety timer is started. After the safety timer expires, charging of the battery will discontinue and no more current will be delivered.

Automatic Recharge

After the battery charger terminates, it will remain off drawing only microamperes of current from the battery. If the portable product remains in this state long enough, the battery will eventually self discharge. To ensure that

the battery is always topped off, a charge cycle will automatically begin when the battery voltage falls below 4.1V. In the event that the safety timer is running when the battery voltage falls below 4.1V, it will reset back to zero. To prevent brief excursions below 4.1V from resetting the safety timer, the battery voltage must be below 4.1V for more than 1.3ms. The charge cycle and safety timer will also restart if the V_{BUS} UVLO cycles low and then high (e.g. V_{BUS} is removed and then replaced), or if the battery charger is cycled on and off by either the I²C port or the \overline{CHRGEN} digital I/O pin.

Charge Current

The charge current is programmed using a single resistor from PROG to ground. $1/1022^{\text{th}}$ of the battery charge current is sent to PROG which will attempt to servo to 1.000V. Thus, the battery charge current will try to reach 1022 times the current in the PROG pin. The program resistor and the charge current are calculated using the following equations:

$$R_{PROG} = \frac{1022V}{I_{CHG}}, I_{CHG} = \frac{1022V}{R_{PROG}}$$

In either the constant-current or constant-voltage charging modes, the voltage at the PROG pin will be proportional to the actual charge current delivered to the battery. Therefore, the actual charge current can be determined at any time by monitoring the PROG pin voltage and using the following equation:

$$I_{BAT} = \frac{V_{PROG}}{R_{PROG}} \cdot 1022$$

In many cases, the actual battery charge current, I_{BAT} , will be lower than I_{CHG} due to limited input power available and prioritization with the system load drawn from V_{OUT} .

Charge Status Indication

The \overline{CHRG} pin indicates the status of the battery charger. Four possible states are represented by \overline{CHRG} which include charging, not charging, unresponsive battery, and battery temperature out of range.

The signal at the \overline{CHRG} pin can be easily recognized as one of the above four states by either a human or a

OPERATION

microprocessor. An open-drain output, the $\overline{\text{CHRG}}$ pin can drive an indicator LED through a current limiting resistor for human interfacing or simply a pull-up resistor for microprocessor interfacing.

To make the $\overline{\text{CHRG}}$ pin easily recognized by both humans and microprocessors, the pin is either low for charging, high for not charging, or it is switched at high frequency (35kHz) to indicate the two possible faults, unresponsive battery and battery temperature out of range.

When charging begins, $\overline{\text{CHRG}}$ is pulled low and remains low for the duration of a normal charge cycle. When charging is complete, i.e., the BAT pin reaches 4.200V and the charge current has dropped to one-tenth of the programmed value, the $\overline{\text{CHRG}}$ pin is released (Hi-Z). If a fault occurs, the pin is switched at 35kHz. While switching, its duty cycle is modulated between a high and low value at a very low frequency. The low and high duty cycles are disparate enough to make an LED appear to be on or off thus giving the appearance of “blinking”. Each of the two faults has its own unique “blink” rate for human recognition as well as two unique duty cycles for machine recognition.

The $\overline{\text{CHRG}}$ pin does not respond to the C/10 threshold if the LTC3567 is in V_{BUS} current limit. This prevents false end of charge indications due to insufficient power available to the battery charger.

Table 1 illustrates the four possible states of the $\overline{\text{CHRG}}$ pin when the battery charger is active.

Table 1. $\overline{\text{CHRG}}$ Signal

STATUS	FREQUENCY	MODULATION (BLINK) FREQUENCY	DUTY CYCLES
Charging	0Hz	0Hz (Lo-Z)	100%
Not Charging	0Hz	0Hz (Hi-Z)	0%
NTC Fault	35kHz	1.5Hz AT 50%	6.25%, 93.75%
Bad Battery	35kHz	6.1Hz AT 50%	12.5%, 87.5%

An NTC fault is represented by a 35kHz pulse train whose duty cycle alternates between 6.25% and 93.75% at a 1.5Hz rate. A human will easily recognize the 1.5Hz rate as a “slow” blinking which indicates the out-of-range battery temperature while a microprocessor will be able to decode either the 6.25% or 93.75% duty cycles as an NTC fault.

If a battery is found to be unresponsive to charging (i.e., its voltage remains below 2.85V for 1/2 hour), the $\overline{\text{CHRG}}$ pin gives the battery fault indication. For this fault, a human would easily recognize the frantic 6.1Hz “fast” blink of the LED while a microprocessor would be able to decode either the 12.5% or 87.5% duty cycles as a bad battery fault.

Note that the LTC3567 is a 3-terminal PowerPath product where system load is always prioritized over battery charging. Due to excessive system load, there may not be sufficient power to charge the battery beyond the trickle charge threshold voltage within the bad battery timeout period. In this case, the battery charger will falsely indicate a bad battery. System software may then reduce the load and reset the battery charger to try again.

Although very improbable, it is possible that a duty cycle reading could be taken at the bright-dim transition (low duty cycle to high duty cycle). When this happens the duty cycle reading will be precisely 50%. If the duty cycle reading is 50%, system software should disqualify it and take a new duty cycle reading.

NTC Thermistor

The battery temperature is measured by placing a negative temperature coefficient (NTC) thermistor close to the battery pack.

To use this feature, connect the NTC thermistor, R_{NTC} , between the NTC pin and ground and a resistor, R_{NOM} , from V_{BUS} to the NTC pin. R_{NOM} should be a 1% resistor with a value equal to the value of the chosen NTC thermistor at 25°C (R25). A 100k thermistor is recommended since thermistor current is not measured by the LTC3567 and will have to be budgeted for USB compliance.

The LTC3567 will pause charging when the resistance of the NTC thermistor drops to 0.54 times the value of R25 or approximately 54k. For Vishay “Curve 1” thermistor, this corresponds to approximately 40°C. If the battery charger is in constant-voltage (float) mode, the safety timer also pauses until the thermistor indicates a return to a valid temperature. As the temperature drops, the resistance of the NTC thermistor rises. The LTC3567 is also designed to pause charging when the value of the NTC thermistor increases to 3.25 times the value of R25. For Vishay “Curve 1” this resistance, 325k, corresponds

3567f

OPERATION

to approximately 0°C. The hot and cold comparators each have approximately 3°C of hysteresis to prevent oscillation about the trip point. Grounding the NTC pin disables the NTC charge pausing function.

Thermal Regulation

To optimize charging time, an internal thermal feedback loop may automatically decrease the programmed charge current. This will occur if the die temperature rises to approximately 110°C. Thermal regulation protects the LTC3567 from excessive temperature due to high power operation or high ambient thermal conditions and allows the user to push the limits of the power handling capability with a given circuit board design without risk of damaging the LTC3567 or external components. The benefit of the LTC3567 thermal regulation loop is that charge current can be set according to actual conditions rather than worst-case conditions with the assurance that the battery charger will automatically reduce the current in worst-case conditions.

I²C Interface

The LTC3567 may receive commands from a host (master) using the standard I²C 2-wire interface. The Timing Diagram shows the timing relationship of the signals on the bus. The two bus lines, SDA and SCL, must be high when the bus is not in use. External pull-up resistors or current sources, such as the LTC1694 I²C accelerator, are required on these lines. The LTC3567 is a receive-only (slave) device. The I²C control signals, SDA and SCL are scaled internally to the DV_{CC} supply. DV_{CC} should be connected to the same power supply as the microcontroller generating the I²C signals.

The I²C port has an undervoltage lockout on the DV_{CC} pin. When the DV_{CC} is below approximately 1V, the I²C serial port is cleared and the buck-boost switching regulator is set to full scale.

Bus Speed

The I²C port is designed to be operated at speeds of up to 400kHz. It has built-in timing delays to ensure correct operation when addressed from an I²C compliant master device. It also contains input filters designed to suppress glitches should the bus become corrupted.

Start and Stop Condition

A bus master signals the beginning of a communication to a slave device by transmitting a Start condition. A Start condition is generated by transitioning SDA from high to low while SCL is high. When the master has finished communicating with the slave, it issues a Stop condition by transitioning SDA from low to high while SCL is high. The bus is then free for communication with another I²C device.

Byte Format

Each byte sent to the LTC3567 must be eight bits long followed by an extra clock cycle for the Acknowledge bit to be returned by the LTC3567. The data should be sent to the LTC3567 most significant bit (MSB) first.

Acknowledge

The Acknowledge signal is used for handshaking between the master and the slave. An Acknowledge (active low) generated by the slave (LTC3567) lets the master know that the latest byte of information was received. The Acknowledge related clock pulse is generated by the master. The master releases the SDA line (high) during the Acknowledge clock cycle. The slave receiver must pull down the SDA line during the Acknowledge clock pulse so that it remains a stable low during the high period of this clock pulse.

Slave Address

The LTC3567 responds to only one 7-bit address which has been factory programmed to 0001001. The LSB of the address byte is 1 for Read and 0 for Write. This device is write only corresponding to an address byte of 00010010 (0x12). If the correct seven bit address is given but the R/W bit is 1, the LTC3567 will not respond.

Bus Write Operation

The master initiates communication with the LTC3567 with a Start condition and a 7-bit address followed by the Write Bit R/W = 0. If the address matches that of the LTC3567, the LTC3567 returns an Acknowledge. The master should then deliver the most significant data byte. Again the LTC3567 acknowledges and the cycle is repeated for

OPERATION

Table 2. I²C Serial Port Mapping (Defaults 0xFF00 in Reset State or if DV_{CC} = 0V)

A7	A6	A5	A4	A3	A2	A1	A0	B7	B6	B5	B4	B3	B2	B1	B0
Reserved for Internal Use				Switching Regulator Voltage (See Table 4)				Disable Battery Charger	Buck-Boost Regulator Mode (See Table 5)	Reserved for Internal Use			Enable Buck-Boost Regulator	Input Current Limit (See Table 3)	

Table 3. USB Current Limit Settings

B1	B0	USB SETTING
0	0	1x Mode (USB 100mA Limit)
0	1	10x Mode (Wall 1A Limit)
1	0	Suspend
1	1	5x Mode (USB 500mA Limit)

Table 4. Buck-Boost Regulator Servo Voltage

A3	A2	A1	A0	SWITCHING REGULATOR SERVO VOLTAGE
0	0	0	0	0.425V
0	0	0	1	0.450V
0	0	1	0	0.475V
0	0	1	1	0.500V
0	1	0	0	0.525V
0	1	0	1	0.550V
0	1	1	0	0.575V
0	1	1	1	0.600V
1	0	0	0	0.625V
1	0	0	1	0.650V
1	0	1	0	0.675V
1	0	1	1	0.700V
1	1	0	0	0.725V
1	1	0	1	0.750V
1	1	1	0	0.775V
1	1	1	1	0.800V

Table 5. Buck-Boost Switching Regulator Modes

B6	SWITCHING REGULATOR MODE
0	PWM Mode
1	Burst Mode Operation

the total of one address byte and two data bytes. Each data byte is transferred to an internal holding latch upon the return of an Acknowledge. After both data bytes have been transferred to the LTC3567, the master may terminate

the communication with a Stop condition. Alternatively, a Repeat-Start condition can be initiated by the master and another chip on the I²C bus can be addressed. This cycle can continue indefinitely and the LTC3567 will remember the last input of valid data that it received. Once all chips on the bus have been addressed and sent valid data, a global Stop condition can be sent and the LTC3567 will update its command latch with the data that it had received.

In certain circumstances the data on the I²C bus may become corrupted. In these cases the LTC3567 responds appropriately by preserving only the last set of complete data that it has received. For example, assume the LTC3567 has been successfully addressed and is receiving data when a Stop condition mistakenly occurs. The LTC3567 will ignore this Stop condition and will not respond until a new Start condition, correct address, new set of data and Stop condition are transmitted.

Likewise, with only one exception, if the LTC3567 was previously addressed and sent valid data but not updated with a Stop, it will respond to any Stop that appears on the bus, independent of the number of Repeat-Starts that have occurred. If a Repeat-Start is given and the LTC3567 successfully acknowledges its address and first byte, it will not respond to a Stop until both bytes of the new data have been received and acknowledged.

Disabling the I²C Port

The I²C serial port can be disabled by grounding the DV_{CC} pin. In this mode, control automatically passes to the individual logic input pins EN1 and $\overline{\text{CHRGEN}}$. However, with the I²C port disabled, the programmable buck-boost switching regulator defaults to a fixed servo voltage of 0.8V in PWM mode, and the USB input current limit defaults to 1x mode (100mA limit). By default the battery charger will be enabled and the buck-boost will be disabled.

OPERATION

Buck-Boost DC/DC Switching Regulator

The LTC3567 contains a 2.25MHz constant-frequency voltage mode buck-boost switching regulator. The regulator provides up to 1A of output load current. The buck-boost can be programmed to a minimum output voltage of 2.75V and can be used to power a microcontroller core, microcontroller I/O, memory, disk drive, or other logic circuitry. When controlled by I²C, the buck-boost has programmable set-points for on-the-fly power savings. To suit a variety of applications, a selectable mode function allows the user to trade off noise for efficiency. Two modes are available to control the operation of the LTC3567's buck-boost regulator. At moderate to heavy loads, the constant frequency PWM mode provides the least noise switching solution. At lighter loads Burst Mode operation may be selected. The full-scale output voltage is programmed by a user-supplied resistive divider returned to the FB1 pin. An error amplifier compares the divided output voltage with a reference and adjusts the compensation voltage accordingly until the FB1 has stabilized to the selected reference voltage (0.425V to 0.8V). The buck-boost regulator also includes a soft-start to limit inrush current and voltage overshoot when powering on, short circuit current protection, and switch node slew limiting circuitry for reduced radiated EMI.

Input Current Limit

The input current limit comparator will shut the input PMOS switch off once current exceeds 2.5A (typical). The 2.5A input current limit also protects against a grounded V_{OUT1} node.

Output Overvoltage Protection

If the FB1 node were inadvertently shorted to ground, then the output would increase indefinitely with the maximum current that could be sourced from V_{IN1}. The LTC3567 protects against this by shutting off the input PMOS if the output voltage exceeds a 5.6V (typical).

Low Output Voltage Operation

When the output voltage is below 2.65V (typical) during start-up, Burst Mode operation is disabled and switch D is turned off (allowing forward current through the well diode and limiting reverse current to 0mA).

Buck-Boost Regulator PWM Operating Mode

In PWM mode the voltage seen at FB1 is compared to the selected reference voltage (0.425V to 0.8V). From the FB1 voltage an error amplifier generates an error signal seen at V_{C1}. This error signal commands PWM waveforms that modulate switches A, B, C, and D. Switches A and B operate synchronously as do switches C and D. If V_{IN1} is significantly greater than the programmed V_{OUT1}, then the converter will operate in buck mode. In this mode switches A and B will be modulated, with switch D always on (and switch C always off), to step down the input voltage to the programmed output. If V_{IN1} is significantly less than the programmed V_{OUT1}, then the converter will operate in boost mode. In this mode switches C and D are modulated, with switch A always on (and switch B always off), to step up the input voltage to the programmed output. If V_{IN1} is close to the programmed V_{OUT1}, then the converter will operate in 4-switch mode. In this mode the switches sequence through the pattern of AD, AC, BD to either step the input voltage up or down to the programmed output.

Buck-Boost Regulator Burst-Mode Operation

In Burst Mode operation, the buck-boost regulator uses a hysteretic FB1 voltage algorithm to control the output voltage. By limiting FET switching and using a hysteretic control loop, switching losses are greatly reduced. In this mode output current is limited to 50mA typical. While operating in Burst Mode operation, the output capacitor is charged to a voltage slightly higher than the regulation point. The buck-boost converter then goes into a sleep state, during which the output capacitor provides the load current. The output capacitor is charged by charging the inductor until the input current reaches 275mA typical and then discharging the inductor until the reverse current reaches 0mA typical. This process is repeated until the feedback voltage has charged to 6mV above the regulation point. In the sleep state, most of the regulator's circuitry is powered down, helping to conserve battery power. When the feedback voltage drops 6mV below the regulation point, the switching regulator circuitry is powered on and another burst cycle begins. The duration for which the regulator sleeps depends on the load current and output capacitor value. The sleep time decreases as the load current increases. The maximum load current in

3567f

OPERATION

Burst Mode operation is 50mA. The buck-boost regulator will not go to sleep if the current is greater than 50mA, and if the load current increases beyond this point while in Burst Mode operation the output will lose regulation. Burst Mode operation provides a significant improvement in efficiency at light loads at the expense of higher output ripple when compared to PWM mode. For many noise-sensitive systems, Burst Mode operation might be undesirable at certain times (i.e., during a transmit or receive cycle of a wireless device), but highly desirable at others (i.e. when the device is in low power standby mode). The B6 bit of the I²C port is used to enable or disable Burst Mode operation at any time, offering both low noise and low power operation when they are needed.

Buck-Boost Regulator Soft-Start Operation

Soft-start is accomplished by gradually increasing the reference voltage input to the error amplifier over a 0.5ms

(typical) period. This limits transient inrush currents during start-up because the output voltage is always “in regulation.” Ramping the reference voltage input also limits the rate of increase in the V_{C1} voltage which helps minimize output overshoot during start-up. A soft-start cycle occurs whenever the buck-boost is enabled, or after a fault condition has occurred (thermal shutdown or UVLO). A soft-start cycle is not triggered by changing operating modes. This allows seamless operation when transitioning between Burst Mode operation and PWM mode.

Low Supply Operation

The LTC3567 incorporates an undervoltage lockout circuit on V_{OUT} (connected to V_{IN1}) which shuts down the buck-boost regulator when V_{OUT} drops below 2.6V. This UVLO prevents unstable operation.

APPLICATIONS INFORMATION

CLPROG Resistor and Capacitor

As described in the High Efficiency Switching PowerPath Controller section, the resistor on the CLPROG pin determines the average input current limit when the switching regulator is set to either the 1x mode (USB 100mA), the 5x mode (USB 500mA) or the 10x mode. The input current will be comprised of two components, the current that is used to drive V_{OUT} and the quiescent current of the switching regulator. To ensure that the USB specification is strictly met, both components of input current should be considered. The Electrical Characteristics table gives values for quiescent currents in either setting as well as current limit programming accuracy. To get as close to the 500mA or 100mA specifications as possible, a 1% resistor should be used. Recall that $I_{VBUS} = I_{VBUSQ} + V_{CLPROG}/R_{CLPROG} \cdot (h_{CLPROG} + 1)$.

An averaging capacitor or an R-C combination is required in parallel with the CLPROG resistor so that the switching regulator can determine the average input current. This network also provides the dominant pole for the feedback

loop when current limit is reached. To ensure stability, the capacitor on CLPROG should be 0.1 μ F or larger.

Choosing the PowerPath Inductor

Because the input voltage range and output voltage range of the PowerPath switching regulator are both fairly narrow, the LTC3567 was designed for a specific inductance value of 3.3 μ H. Some inductors which may be suitable for this application are listed in Table 6.

Table 6. Recommended Inductors for PowerPath Controller

INDUCTOR TYPE	L (μ H)	MAX I_{DC} (A)	MAX DCR (Ω)	SIZE IN mm (L x W x H)	MANUFACTURER
LPS4018	3.3	2.2	0.08	3.9 x 3.9 x 1.7	Coilcraft www.coilcraft.com
D53LC	3.3	2.26	0.034	5.0 x 5.0 x 3.0	Toko
DB318C	3.3	1.55	0.070	3.8 x 3.8 x 1.8	www.toko.com
WE-TPC Type M1	3.3	1.95	0.065	4.8 x 4.8 x 1.8	Würth Elektronik www.we-online.com
CDRH6D12	3.3	2.2	0.0625	6.7 x 6.7 x 1.5	Sumida
CDRH6D38	3.3	3.5	0.020	7.0 x 7.0 x 4.0	www.sumida.com

APPLICATIONS INFORMATION

V_{BUS} and V_{OUT} Bypass Capacitors

The style and value of capacitors used with the LTC3567 determine several important parameters such as regulator control-loop stability and input voltage ripple. Because the LTC3567 uses a step-down switching power supply from V_{BUS} to V_{OUT} , its input current waveform contains high frequency components. It is strongly recommended that a low equivalent series resistance (ESR) multilayer ceramic capacitor be used to bypass V_{BUS} . Tantalum and aluminum capacitors are not recommended because of their high ESR. The value of the capacitor on V_{BUS} directly controls the amount of input ripple for a given load current. Increasing the size of this capacitor will reduce the input ripple.

To prevent large V_{OUT} voltage steps during transient load conditions, it is also recommended that a ceramic capacitor be used to bypass V_{OUT} . The output capacitor is used in the compensation of the switching regulator. At least 4 μ F of actual capacitance with low ESR are required on V_{OUT} . Additional capacitance will improve load transient performance and stability.

Multilayer ceramic chip capacitors typically have exceptional ESR performance. MLCCs combined with a tight board layout and an unbroken ground plane will yield very good performance and low EMI emissions.

There are several types of ceramic capacitors available, each having considerably different characteristics. For example, X7R ceramic capacitors have the best voltage and temperature stability. X5R ceramic capacitors have apparently higher packing density but poorer performance over their rated voltage and temperature ranges. Y5V ceramic capacitors have the highest packing density, but must be used with caution, because of their extreme nonlinear characteristic of capacitance vs voltage. The actual in-circuit capacitance of a ceramic capacitor should be measured with a small AC signal (ideally less than 200mV) as is expected in-circuit. Many vendors specify the capacitance vs voltage with a 1V_{RMS} AC test signal and as a result overstate the capacitance that the capacitor will present in the application. Using similar operating conditions as the application, the user must measure or request from the vendor the actual capacitance to determine if the selected capacitor meets the minimum capacitance that the application requires.

Buck-Boost Regulator Inductor Selection

Many different sizes and shapes of inductors are available from numerous manufacturers. Choosing the right inductor from such a large selection of devices can be overwhelming, but following a few basic guidelines will make the selection process much simpler.

The buck-boost converter is designed to work with inductors in the range of 1 μ H to 5 μ H. For most applications a 2.2 μ H inductor will suffice. Larger value inductors reduce ripple current which improves output ripple voltage. Lower value inductors result in higher ripple current and improved transient response time. To maximize efficiency, choose an inductor with a low DC resistance. For a 3.3V output, efficiency is reduced about 3% for a 100m Ω series resistance at 1A load current, and about 2% for 300m Ω series resistance at 200mA load current. Choose an inductor with a DC current rating at least two times larger than the maximum load current to ensure that the inductor does not saturate during normal operation. If output short circuit is a possible condition, the inductor should be rated to handle the 2.5A maximum peak current specified for the buck-boost converter.

Different core materials and shapes will change the size/current and price/current relationship of an inductor. Toroid or shielded pot cores in ferrite or Permalloy materials are small and do not radiate much energy, but generally cost more than powdered iron core inductors with similar electrical characteristics. Inductors that are very thin or have a very small volume typically have much higher core and DCR losses, and will not give the best efficiency. The choice of which style inductor to use often depends more on the price vs size, performance and any radiated EMI requirements than on what the LTC3567 requires to operate.

The inductor value also has an effect on Burst Mode operation. Lower inductor values will cause the Burst Mode operation switching frequencies to increase.

Table 7 shows several inductors that work well with the LTC3567's buck-boost regulator. These inductors offer a good compromise in current rating, DCR and physical size. Consult each manufacturer for detailed information on their entire selection of inductors.

APPLICATIONS INFORMATION

Table 7. Recommended Inductors for Buck-Boost Regulator

INDUCTOR TYPE	L (μH)	MAX I _{DC} (A)	MAX DCR (Ω)	SIZE IN mm (L × W × H)	MANUFACTURER
LPS4018	3.3 2.2	2.2 2.5	0.08 0.07	3.9 × 3.9 × 1.7 3.9 × 3.9 × 1.7	Coilcraft www.coilcraft.com
D53LC	2.0	3.25	0.02	5.0 × 5.0 × 3.0	Toko www.toko.com
7440430022	2.2	2.5	0.028	4.8 × 4.8 × 2.8	Würth-Elektronik www.we-online.com
CDRH4D22/HP	2.2	2.4	0.044	4.7 × 4.7 × 2.4	Sumida www.sumida.com
SD14	2.0	2.56	0.045	5.2 × 5.2 × 1.45	Cooper www.cooper.com

Buck-Boost Regulator Input/Output Capacitor Selection

Low ESR MLCC capacitors should also be used at both the buck-boost regulator output (V_{OUT1}) and the buck-boost regulator input supply (V_{IN1}). Only X5R or X7R ceramic capacitors should be used because they retain their capacitance over wider voltage and temperature ranges than other ceramic types. A 22μF output capacitor is sufficient for most applications. The buck-boost regulator input supply should be bypassed with a 2.2μF capacitor. Consult with capacitor manufacturers for detailed information on their selection and specifications of ceramic capacitors. Many manufacturers now offer very thin (<1mm tall) ceramic capacitors ideal for use in height restricted designs. Table 8 shows a list of several ceramic capacitor manufacturers.

Table 8. Recommended Ceramic Capacitor Manufacturers

MANUFACTURER	WEBSITE
AVX	www.avxcorp.com
Murata	www.murata.com
Taiyo Yuden	www.t-yuden.com
Vishay Siliconix	www.vishay.com
TDK	www.tdk.com

Over-Programming the Battery Charger

The USB high power specification allows for up to 2.5W to be drawn from the USB port (5V × 500mA). The PowerPath switching regulator transforms the voltage at V_{BUS} to just above the voltage at BAT with high efficiency, while limiting power to less than the amount programmed at CLPROG.

In some cases the battery charger may be programmed (with the PROG pin) to deliver the maximum safe charging current without regard to the USB specifications. If there is insufficient current available to charge the battery at the programmed rate, the PowerPath regulator will reduce charge current until the system load on V_{OUT} is satisfied and the V_{BUS} current limit is satisfied. Programming the battery charger for more current than is available will not cause the average input current limit to be violated. It will merely allow the battery charger to make use of all available power to charge the battery as quickly as possible, and with minimal power dissipation within the battery charger.

Alternate NTC Thermistors and Biasing

The LTC3567 provides temperature qualified charging if a grounded thermistor and a bias resistor are connected to NTC. By using a bias resistor whose value is equal to the room temperature resistance of the thermistor (R25) the upper and lower temperatures are pre-programmed to approximately 40°C and 0°C, respectively (assuming a Vishay “Curve 1” thermistor).

The upper and lower temperature thresholds can be adjusted by either a modification of the bias resistor value or by adding a second adjustment resistor to the circuit. If only the bias resistor is adjusted, then either the upper or the lower threshold can be modified but not both. The other trip point will be determined by the characteristics of the thermistor. Using the bias resistor in addition to an adjustment resistor, both the upper and the lower temperature trip points can be independently programmed with the constraint that the difference between the upper and lower temperature thresholds cannot decrease. Examples of each technique follow.

NTC thermistors have temperature characteristics which are indicated on resistance-temperature conversion tables. The Vishay-Dale thermistor NTHS0603N011-N1003F, used in the following examples, has a nominal value of 100k and follows the Vishay “Curve 1” resistance-temperature characteristic.

In the explanation below, the following notation is used.

R25 = Value of the thermistor at 25°C

R_{NTC|COLD} = Value of thermistor at the cold trip point

APPLICATIONS INFORMATION

$R_{NTC|HOT}$ = Value of thermistor at the hot trip point

r_{COLD} = Ratio of $R_{NTC|COLD}$ to R25

r_{HOT} = Ratio of $R_{NTC|HOT}$ to R25

R_{NOM} = Primary thermistor bias resistor (see Figure 4a)

R1 = Optional temperature range adjustment resistor (see Figure 4b)

The trip points for the LTC3567's temperature qualification are internally programmed at $0.349 \cdot V_{BUS}$ for the hot threshold and $0.765 \cdot V_{BUS}$ for the cold threshold.

Therefore, the hot trip point is set when:

$$\frac{R_{NTC|HOT}}{R_{NOM} + R_{NTC|HOT}} \cdot V_{BUS} = 0.349 \cdot V_{BUS}$$

and the cold trip point is set when:

$$\frac{R_{NTC|COLD}}{R_{NOM} + R_{NTC|COLD}} \cdot V_{BUS} = 0.765 \cdot V_{BUS}$$

Solving these equations for $R_{NTC|COLD}$ and $R_{NTC|HOT}$ results in the following:

$$R_{NTC|HOT} = 0.536 \cdot R_{NOM}$$

and

$$R_{NTC|COLD} = 3.25 \cdot R_{NOM}$$

By setting R_{NOM} equal to R25, the above equations result in $r_{HOT} = 0.536$ and $r_{COLD} = 3.25$. Referencing these ratios to the Vishay Resistance-Temperature Curve 1 chart gives a hot trip point of about 40°C and a cold trip point of about 0°C. The difference between the hot and cold trip points is approximately 40°C.

By using a bias resistor, R_{NOM} , different in value from R25, the hot and cold trip points can be moved in either direction. The temperature span will change somewhat due to the nonlinear behavior of the thermistor. The following equations can be used to easily calculate a new value for the bias resistor:

$$R_{NOM} = \frac{r_{HOT}}{0.536} \cdot R25$$

$$R_{NOM} = \frac{r_{COLD}}{3.25} \cdot R25$$

where r_{HOT} and r_{COLD} are the resistance ratios at the desired hot and cold trip points. Note that these equations are linked. Therefore, only one of the two trip points can be chosen, the other is determined by the default ratios designed in the IC. Consider an example where a 60°C hot trip point is desired.

From the Vishay Curve 1 R-T characteristics, r_{HOT} is 0.2488 at 60°C. Using the above equation, R_{NOM} should be set to 46.4k. With this value of R_{NOM} , the cold trip point is about 16°C. Notice that the span is now 44°C rather than the previous 40°C. This is due to the decrease in "temperature gain" of the thermistor as absolute temperature increases.

The upper and lower temperature trip points can be independently programmed by using an additional bias resistor as shown in Figure 4b. The following formulas can be used to compute the values of R_{NOM} and R1:

$$R_{NOM} = \frac{r_{COLD} - r_{HOT}}{2.714} \cdot R25$$

$$R1 = 0.536 \cdot R_{NOM} - r_{HOT} \cdot R25$$

For example, to set the trip points to 0°C and 45°C with a Vishay Curve 1 thermistor choose

$$R_{NOM} = \frac{3.266 - 0.4368}{2.714} \cdot 100k = 104.2k$$

The nearest 1% value is 105k

$$R1 = 0.536 \cdot 105k - 0.4368 \cdot 100k = 12.6k$$

The nearest 1% value is 12.7k. The final solution is shown in Figure 4b and results in an upper trip point of 45°C and a lower trip point of 0°C.

USB Inrush Limiting

When a USB cable is plugged into a portable product, the inductance of the cable and the high-Q ceramic input capacitor form an L-C resonant circuit. If the cable does not have adequate mutual coupling or if there is not much impedance in the cable, it is possible for the voltage at the input of the product to reach as high as twice the USB voltage (~10V) before it settles out. To prevent excessive voltage from damaging the LTC3567 during a hot insertion,

APPLICATIONS INFORMATION

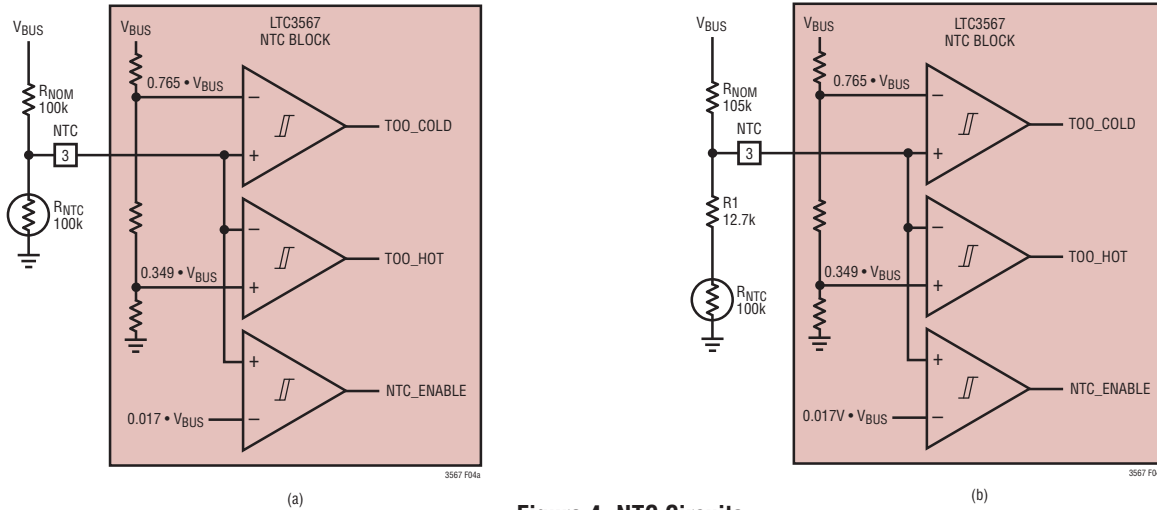

Figure 4. NTC Circuits

it is best to have a low voltage coefficient capacitor at the V_{BUS} pin to the LTC3567. This is achievable by selecting an MLCC capacitor that has a higher voltage rating than that required for the application. For example, a 16V, X5R, 10 μ F capacitor in a 1206 case would be a more conservative choice than a 6.3V, X5R, 10 μ F capacitor in a smaller 0805 case. The size of the input overshoot will be determined by the “Q” of the resonant tank circuit formed by C_{IN} and the input lead inductance. It is recommended to measure the input ringing with the selected components to verify compliance with the Absolute Maximum specifications.

Alternatively, the following soft connect circuit (Figure 5) can be employed. In this circuit, capacitor C1 holds MP1 off when the cable is first connected. Eventually C1 begins to charge up to the USB input voltage applying increasing gate support to MP1. The long time constant of R1 and C1 prevent the current from building up in the cable too fast thus dampening out any resonant overshoot.

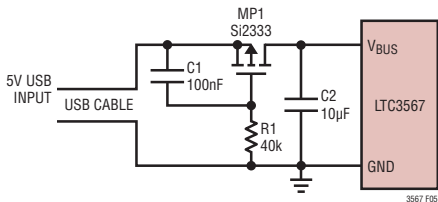

Figure 5. USB Soft Connect Circuit

Buck-Boost Regulator Output Voltage Programming

The buck-boost regulator can be programmed for output voltages greater than 2.75V and less than 5.5V. The full-

scale output voltage is programmed using a resistor divider from the V_{OUT1} pin connected to the FB1 pin such that:

$$V_{OUT1} = V_{FB1} \left(\frac{R1}{R_{FB}} + 1 \right)$$

where V_{FB1} ranges from 0.425V to 0.8V (see Figure 6).

Closing the Feedback Loop

The LTC3567 incorporates voltage mode PWM control. The control to output gain varies with operation region (buck, boost, buck-boost), but is usually no greater than 20. The output filter exhibits a double pole response given by:

$$f_{FILTER_POLE} = \frac{1}{2 \cdot \pi \cdot \sqrt{L \cdot C_{OUT}}} \text{ Hz}$$

Where C_{OUT} is the output filter capacitor.

The output filter zero is given by:

$$f_{FILTER_ZERO} = \frac{1}{2 \cdot \pi \cdot R_{ESR} \cdot C_{OUT}} \text{ Hz}$$

where R_{ESR} is the capacitor equivalent series resistance.

A troublesome feature in boost mode is the right-half plane zero (RHP), and is given by:

$$f_{RHPZ} = \frac{V_{IN1}^2}{2 \cdot \pi \cdot I_{OUT} \cdot L \cdot V_{OUT1}} \text{ Hz}$$

The loop gain is typically rolled off before the RHP zero frequency.

APPLICATIONS INFORMATION

A simple Type I compensation network (as shown in Figure 6) can be incorporated to stabilize the loop but at the cost of reduced bandwidth and slower transient response. To ensure proper phase margin, the loop must cross unity-gain a decade before the LC double pole.

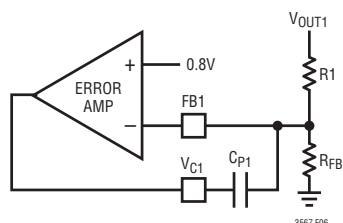

Figure 6. Error Amplifier with Type I Compensation

The unity-gain frequency of the error amplifier with the Type I compensation is given by:

$$f_{UG} = \frac{1}{2 \cdot \pi \cdot R1 \cdot C_{P1}} \text{ Hz}$$

Most applications demand an improved transient response to allow a smaller output filter capacitor. To achieve a higher bandwidth, Type III compensation is required. Two zeros are required to compensate for the double-pole response. Type III compensation also reduces any V_{OUT1} overshoot seen at start-up.

The compensation network depicted in Figure 7 yields the transfer function:

$$\frac{V_{C1}}{V_{OUT1}} = \frac{1}{R1 \cdot (C1 + C2)} \cdot \frac{(1 + sR2C2) \cdot (1 + s(R1 + R3)C3)}{s \cdot \left(1 + \frac{sR2C1C2}{C1 + C2}\right) \cdot (1 + sR3C3)}$$

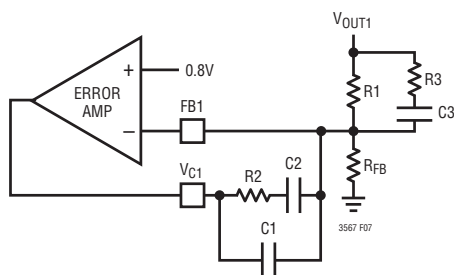

Figure 7. Error Amplifier with Type III Compensation

A Type III compensation network attempts to introduce a phase bump at a higher frequency than the LC double pole. This allows the system to cross unity gain after the LC double pole, and achieve a higher bandwidth. While

attempting to cross over after the LC double pole, the system must still cross over before the boost right-half plane zero. If unity gain is not reached sufficiently before the right-half plane zero, then the -180° of phase lag from the LC double pole combined with the -90° of phase lag from the right-half plane zero will result in negating the phase bump of the compensator.

The compensator zeros should be placed either before or only slightly after the LC double pole such that their positive phase contributions offset the -180° that occurs at the filter double pole. If they are placed at too low of a frequency, they will introduce too much gain to the system and the crossover frequency will be too high. The two high frequency poles should be placed such that the system crosses unity gain during the phase bump introduced by the zeros and before the boost right-half plane zero and such that the compensator bandwidth is less than the bandwidth of the error amp (typically 900kHz). If the gain of the compensation network is ever greater than the gain of the error amplifier, then the error amplifier no longer acts as an ideal op-amp, and another pole will be introduced at the same point.

Recommended Type III compensation components for a 3.3V output:

R1: 324k Ω

R_{FB}: 105k Ω

C1: 10pF

R2: 15k Ω

C2: 330pF

R3: 121k Ω

C3: 33pF

C_{OUT}: 22 μ F

L_{OUT}: 2.2 μ H

Printed Circuit Board Layout Considerations

In order to be able to deliver maximum current under all conditions, it is critical that the Exposed Pad on the backside of the LTC3567 package be soldered to the PC board ground. Failure to make thermal contact between

APPLICATIONS INFORMATION

the Exposed Pad on the backside of the package and the copper board will result in higher thermal resistances.

Furthermore, due to its high frequency switching circuitry, it is imperative that the input capacitors, inductors, and output capacitors be as close to the LTC3567 as possible and that there be an unbroken ground plane under the LTC3567 and all of its external high frequency components. High frequency currents, such as the V_{BUS} , V_{IN1} , and V_{OUT1} currents on the LTC3567, tend to find their way along the ground plane in a myriad of paths ranging from directly back to a mirror path beneath the incident path on the top of the board. If there are slits or cuts in the ground plane due to other traces on that layer, the current will be forced to go around the slits. If high frequency currents are not allowed to flow back through their natural least-area path, excessive voltage will build up and radiated emissions will occur. There should be a group of vias under the grounded backside of the package leading directly down to an internal ground plane. To minimize parasitic inductance, the ground plane should be on the second layer of the PC board.

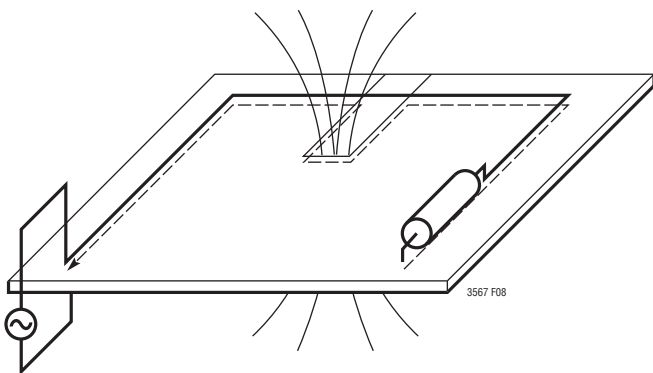

Figure 8. Higher Frequency Ground Currents Follow Their Incident Path. Slits in the Ground Plane Cause High Voltage and Increased Emissions.

The GATE pin for the external ideal diode controller has extremely limited drive current. Care must be taken to minimize leakage to adjacent PC board traces. 100nA of leakage from this pin will introduce an offset to the 15mV ideal diode of approximately 10mV. To minimize leakage, the trace can be guarded on the PC board by surrounding it with V_{OUT} connected metal, which should generally be less than one volt higher than GATE.

When laying out the printed circuit board, the following checklist should be used to ensure proper operation of the LTC3567.

1. Are the capacitors at V_{BUS} , V_{IN1} , and V_{OUT1} as close as possible to the LTC3567? These capacitors provide the AC current to the internal power MOSFETs and their drivers. Minimizing inductance from these capacitors to the LTC3567 is a top priority.
2. Are C_{OUT} and L1 closely connected? The (-) plate of C_{OUT} returns current to the GND plane, and then back to C_{IN} .
3. Keep sensitive components away from the SW pins.

Battery Charger Stability Considerations

The LTC3567's battery charger contains both a constant-voltage and a constant-current control loop. The constant-voltage loop is stable without any compensation when a battery is connected with low impedance leads. Excessive lead length, however, may add enough series inductance to require a bypass capacitor of at least 1 μ F from BAT to GND. Furthermore, when the battery is disconnected, a 4.7 μ F capacitor in series with a 0.2 Ω to 1 Ω resistor from BAT to GND is required to keep ripple voltage low.

High value, low ESR multilayer ceramic chip capacitors reduce the constant-voltage loop phase margin, possibly resulting in instability. Ceramic capacitors up to 22 μ F may be used in parallel with a battery, but larger ceramics should be decoupled with 0.2 Ω to 1 Ω of series resistance.

In constant-current mode, the PROG pin is in the feedback loop rather than the battery voltage. Because of the additional pole created by any PROG pin capacitance, capacitance on this pin must be kept to a minimum. With no additional capacitance on the PROG pin, the battery charger is stable with program resistor values as high as 25k. However, additional capacitance on this node reduces the maximum allowed program resistor. The pole frequency at the PROG pin should be kept above 100kHz. Therefore, if the PROG pin has a parasitic capacitance, C_{PROG} , the following equation should be used to calculate the maximum resistance value for R_{PROG} :

$$R_{PROG} \leq \frac{1}{2\pi \cdot 100\text{kHz} \cdot C_{PROG}}$$

RELATED PARTS

PART NUMBER	DESCRIPTION	COMMENTS
LTC3440	600mA (I_{OUT}), 2MHz Synchronous Buck-Boost DC/DC Converter	V_{IN} : 2.5V to 5.5V, V_{OUT} : 2.5V to 5.5V $I_Q = 25\mu A$, $I_{SD} < 1\mu A$, MS, DFN Package
LTC3441/ LTC3442	1.2A (I_{OUT}), Synchronous Buck-Boost DC/DC Converters, LTC3441 (1MHz), LTC3443 (600kHz)	V_{IN} : 2.5V to 5.5V, V_{OUT} : 2.4V to 5.25V $I_Q = 25\mu A$, $I_{SD} < 1\mu A$, MS, DFN Package
LTC3442	1.2A (I_{OUT}), 2MHz Synchronous Buck-Boost DC/DC Converter	V_{IN} : 2.4V to 5.5V, V_{OUT} : 2.4V to 5.25V $I_Q = 28\mu A$, $I_{SD} < 1\mu A$, MS Package
LTC3455	Dual DC/DC Converter with USB Power Management and Li-Ion Battery Charger	Efficiency >96%, Accurate USB Current Limiting (500mA/100mA), 4mm × 4mm QFN-24 Package
LTC3538	800mA, 2MHz Synchronous Buck-Boost DC/DC Converter	V_{IN} : 2.4V to 5.5V, V_{OUT} : 1.8V to 5.25V $I_Q = 35\mu A$, 2mm × 3mm DFN-8 Package
LTC3550	Dual Input USB/AC Adapter Li-Ion Battery Charger with adjustable output 600mA Buck Converter	Synchronous Buck Converter, Efficiency: 93%, Adjustable Output at 600mA; Charge Current: 950mA Programmable, USB Compatible, Automatic Input Power Detection and Selection, 3mm × 5mm DFN-16 Package
LTC3550-1	Dual Input USB/AC Adapter Li-Ion Battery Charger with 600mA Buck Converter	Synchronous Buck Converter, Efficiency: 93%, Output: 1.875V at 600mA; Charge Current: 950mA Programmable, USB Compatible, Automatic Input Power Detection and Selection, 3mm × 5mm DFN-16 Package
LTC3555	Switching USB Power Manager with Li-Ion/Polymer Charger, Triple Synchronous Buck Converter Plus LDO	Complete Multi-Function PMIC: Switchmode Power Manager and Three Buck Regulators Plus LDO; Charge Current Programmable Up to 1.5A from Wall Adapter Input, Thermal Regulation Synchronous Buck Converters Efficiency: >95%, ADJ Outputs: 0.8V to 3.6V at 400mA/400mA/1A Bat-Track Adaptive Output Control, 200mΩ Ideal Diode, 4mm × 5mm QFN-28 Package
LTC3556	Switching USB Power Manager with Li-Ion/Polymer Charger, 1A Buck-Boost Plus Dual Sync Buck Converter Plus LDO	Complete Multi-Function PMIC: Switching Power Manager, 1A Buck-Boost Plus 2 Buck Regulators Plus LDO, ADJ Out Down to 0.8V at 400mA/400mA/1A, Synchronous Buck/Buck-Boost Converter Efficiency: >95%; Charge Current Programmable up to 1.5A from Wall Adapter Input, Thermal Regulation, Bat-Track Adaptive Output Control, 180mΩ Ideal Diode, 4mm × 5mm QFN-28 Package
LTC3557/ LTC3557-1	USB Power Manager with Li-Ion/Polymer Charger, Triple Synchronous Buck Converter Plus LDO	Complete Multi-Function PMIC: Linear Power Manager and Three Buck Regulators Charge Current Programmable Up to 1.5A from Wall Adapter Input, Thermal Regulation Synchronous Buck Converters Efficiency: >95%, ADJ Output: 0.8V to 3.6V at 400mA/400mA/600mA Bat-Track Adaptive Output Control, 200mΩ Ideal Diode, 4mm × 4mm QFN-28 Package
LTC3559	Linear USB Li-Ion/Polymer Battery Charger with Dual Synchronous Buck Converter	Adjustable Synchronous Buck Converters, Efficiency: >90%, Outputs: Down to 0.8V at 400mA for Each, Charge Current Programmable Up to 950mA, USB Compatible, 3mm × 3mm QFN-16 Package
LTC3566	Switching USB Power Manager with Li-Ion/Polymer Charger, 1A Buck-Boost Converter Plus LDO	Multi-Function PMIC: Switchmode Power Manager and 1A Buck-Boost Regulator Plus LDO, Charge Current Programmable up to 1.5A from Wall Adapter Input, Thermal Regulation Synchronous Buck-Boost Converters Efficiency: >95%, ADJ Output: Down to 0.8V at 1A, Bat-Track Adaptive Output Control, 180mΩ Ideal Diode, 4mm × 4mm QFN-24 Package
LTC4055	USB Power Controller and Battery Charger	Charges Single-Cell Li-Ion Batteries Directly From USB Port, Thermal Regulation, 4mm × 4mm QFN-16 Package
LTC4067	Linear USB Power Manager with OVP, Ideal Diode Controller and Li-Ion Charger	13V Overvoltage Transient Protection, Thermal Regulation 200mΩ Ideal Diode with <50mΩ Option, 3mm × 4mm QFN-14 Package
LTC4085	Linear USB Power Manager with Ideal Diode Controller and Li-Ion Charger	Charges Single Cell Li-Ion Batteries Directly from a USB Port, Thermal Regulation, 200mΩ Ideal Diode with <50mΩ Option, 3mm × 4mm QFN-14 Package
LTC4088	High Efficiency USB Power Manager and Battery Charger	Maximizes Available Power from USB Port, Bat-Track, "Instant-On" Operation, 1.5A Maximum Charge Current, 180mΩ Ideal Diode with <50mΩ Option, 3.3V/25mA Always-On LDO, 3mm × 4mm DFN-14 Package
LTC4088-1/ LTC4088/2	High Efficiency USB Power Manager and Battery Charger with Regulated Output Voltage	Maximizes Available Power from USB Port, Bat-Track, "Instant-On" Operation, 1.5A Maximum Charge Current, 180mΩ Ideal Diode with <50mΩ Option, Automatic Charge Current Reduction Maintains 3.6V Minimum V_{OUT} , Battery Charger Disabled when all Logic Inputs are Grounded, 3mm × 4mm DFN-14 Package