

EVALUATION KIT
AVAILABLE

MAXIM

Single 1.2A USB Switch in 3mm x 3mm TDFN

MAX8586

General Description

The MAX8586 single current-limited switch controls up to 1.2A to power USB applications and has multiple protection features including thermal shutdown, internal current limiting, and reverse current protection. The thermal shutdown limits junction temperature during a prolonged short or overload condition. The internal current-limiting circuitry protects the input supply against overload and is programmable using an external resistor. The MAX8586 meets all IEC specifications for USB ports.

The IC latches off when the output experiences a short circuit for more than 20ms, saving system power. Auto-restart tests the shorted output with a 25mA current to determine if the short still exists. Once the short is removed, the MAX8586 automatically restarts the output. An open-drain fault signal notifies the system that the internal current limit has been reached. A 20ms fault-blanking feature allows the circuit to ignore momentary faults such as those caused when hot-swapping into a capacitive load. An ENRESET input is available to disable the auto-restart function.

The MAX8586 features a SEL input that programs ON to be either active high or active low. The IC is supplied in a space-saving, 8-pin, 3mm x 3mm TDFN package.

Applications

USB Ports/Hubs
Desktop/Notebook Computers
PDAs and Palmtop Computers
Docking Stations

Features

- ◆ Reverse Current Protection
- ◆ Programmable Current Limit Up to 1.2A
- ◆ Accurate Current Limit
- ◆ Selectable Auto-Restart when Fault Is Removed
- ◆ Thermal-Overload Protection
- ◆ Selectable Active-High/Low ON Input
- ◆ Built-In 20ms Fault Blanking
- ◆ Compliant with All USB Specifications
- ◆ 2.75V to 5.5V Input Supply Range
- ◆ FAULT Indicator Output
- ◆ 15kV ESD Protection (with Caps)
- ◆ Tiny 8-Pin 3mm x 3mm TDFN Package

Ordering Information

PART	TEMP RANGE	PIN-PACKAGE	TOP MARK
MAX8586ETA	-40°C to +85°C	8 TDFN 3mm x 3mm (T833-2)	AMH
MAX8586ETA/V+	-40°C to +85°C	8 TDFN 3mm x 3mm (T833-2)	BLU

V denotes an automotive qualified part.

+ Denotes a lead(Pb)-free/RoHS-compliant package.

Typical Operating Circuit

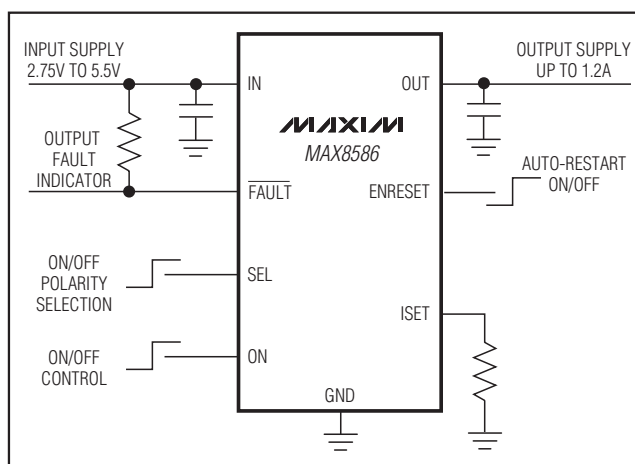

Pin Configuration appears at end of data sheet.

MAXIM

Maxim Integrated Products 1

For pricing, delivery, and ordering information, please contact Maxim Direct at 1-888-629-4642, or visit Maxim's website at www.maxim-ic.com.

Single 1.2A USB Switch in 3mm x 3mm TDFN

ABSOLUTE MAXIMUM RATINGS

IN, ON, SEL, OUT, FAULT, ISET, ENRESET to GND ...-0.3V to +6V
 IN to OUT-6V to +6V
 FAULT Sink Current20mA
 Continuous Power Dissipation
 8-Pin 3mm x 3mm TDFN
 (derate 24mW/°C above +70°C).....1951mW

Operating Temperature Range-40°C to +85°C
 Junction Temperature+150°C
 Storage Temperature Range-65°C to +150°C
 Soldering Temperature (reflow)+260°C

Stresses beyond those listed under "Absolute Maximum Ratings" may cause permanent damage to the device. These are stress ratings only, and functional operation of the device at these or any other conditions beyond those indicated in the operational sections of the specifications is not implied. Exposure to absolute maximum rating conditions for extended periods may affect device reliability.

ELECTRICAL CHARACTERISTICS

($V_{IN} = V_{ON} = V_{SEL} = V_{ENRESET} = 5V$, $R_{ISET} = 26k\Omega$ to GND, $R_{FAULT} = 100k\Omega$ pullup to V_{IN} , $C_{OUT} = 0.1\mu F$, $T_A = -40^\circ C$ to $+85^\circ C$. Typical values are at $T_A = +25^\circ C$, unless otherwise specified.) (Note 1)

PARAMETER	CONDITIONS		MIN	TYP	MAX	UNITS
Supply Voltage Range			2.75		5.50	V
Switch On-Resistance	$V_{IN} = 5V$		55			m Ω
	$V_{IN} = 3V$		65			
	$V_{IN} = 4.4V$		95			
IN Standby Supply Current	$V_{ON} = 0V$		3		6	μA
IN Quiescent Supply Current	$I_{OUT} = 0A$		30		55	μA
OUT Off-Leakage Current	$V_{ON} = 0V$, $V_{OUT} = 0V$	$T_A = +25^\circ C$	0.02		1	μA
		$T_A = +85^\circ C$	0.6			
Undervoltage-Lockout Threshold	Rising edge, 3% hysteresis (typ)		2.3	2.5	2.7	V
Current-Limit Threshold	$R_{ISET} = 26k\Omega$		1.2	1.4	1.6	A
	$R_{ISET} = 39k\Omega$		0.800	0.925	1.050	
	$R_{ISET} = 60k\Omega$		0.5	0.6	0.7	
Peak Short-Circuit Current Limit	$V_{OUT} = 0V$, (I_{OUT} pulsing)	$R_{ISET} = 26k\Omega$	1.35	1.75	2.20	A (Peak)
		$R_{ISET} = 39k\Omega$	1.2			
		$R_{ISET} = 60k\Omega$	0.74			
RMS Short-Circuit Current Limit	$V_{OUT} = 0V$, (I_{OUT} pulsing)	$R_{ISET} = 26k\Omega$	0.55			A (RMS)
		$R_{ISET} = 39k\Omega$	0.37			
		$R_{ISET} = 60k\Omega$	0.23			
Short-Circuit/Continuous Current Limit Transition Threshold	(Note 2)		1			V
Fault-Blanking Timeout Period	From current-limit condition to FAULT falling		8	20	40	ms

Single 1.2A USB Switch in 3mm x 3mm TDFN

MAX8586

ELECTRICAL CHARACTERISTICS (continued)

($V_{IN} = V_{ON} = V_{SEL} = V_{ENRESET} = 5V$, $R_{ISET} = 26k\Omega$ to GND, $R_{FAULT} = 100k\Omega$ pullup to V_{IN} , $C_{OUT} = 0.1\mu F$, $T_A = -40^\circ C$ to $+85^\circ C$. Typical values are at $T_A = +25^\circ C$, unless otherwise specified.) (Note 1)

PARAMETER	CONDITIONS	MIN	TYP	MAX	UNITS
Turn-On Delay	$R_{OUT} = 10\Omega$, $C_{OUT} = 1\mu F$, measured from ON rising to 10% of V_{OUT} , does not include rise time	0.5	1.5	4.0	ms
Output Rise Time	$R_{OUT} = 10\Omega$, $C_{OUT} = 1\mu F$, measured from 10% to 90% of V_{OUT}		5.5		ms
Turn-Off Delay from ON	$R_{OUT} = 10\Omega$, $C_{OUT} = 1\mu F$ measured from ON falling to 90% of V_{OUT}		100	1000	μs
Output Fall Time	$R_{OUT} = 10\Omega$, $C_{OUT} = 1\mu F$, measured from 90% to 10% of V_{OUT}		4		ms
Thermal-Shutdown Threshold	15°C hysteresis (typ)		+160		°C
ON, SEL, ENRESET Logic Input High Voltage	$V_{IN} = 2.75V$ to 4.0V	1.6			V
	$V_{IN} = 4.0V$ to 5.5V	2.0			
ON, SEL, ENRESET Logic Input Low Voltage	$V_{IN} = 2.75V$ to 4.0V			0.6	V
	$V_{IN} = 4.0V$ to 5.5V			0.8	
Logic Input Current	$T_A = +25^\circ C$	-1		+1	μA
FAULT Output Low Voltage	$I_{SINK} = 1mA$			0.4	V
FAULT Output High Leakage Current	$V_{IN} = 5.5V$, $T_A = +25^\circ C$			1	μA
ISET Current-Limit Trip Point	$R_{ISET} = 26k\Omega$		600		mV
ISET External Resistance Range		26		60	k Ω
Auto-Restart Current	In latched-off state, $V_{OUT} = 0V$	10	25	60	mA
Auto-Restart Threshold	In latched-off state, V_{OUT} rising	0.4	0.5	0.6	V
Auto-Restart Delay	In latched-off state, $V_{OUT} > 1V$	8	20	40	ms

Note 1: All devices are 100% production tested at $T_A = +25^\circ C$. Limits over the operating temperature range are guaranteed by design.

Note 2: The output voltage at which the device transitions from short-circuit current limit to continuous current limit.

Single 1.2A USB Switch in 3mm x 3mm TDFN

Typical Operating Characteristics

(Typical Application Circuit, $V_{IN} = V_{ON} = V_{SEL} = V_{ENRESET} = 5V$, $T_A = +25^\circ C$, unless otherwise noted.)

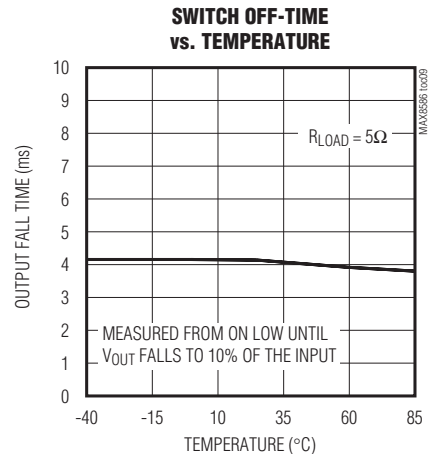
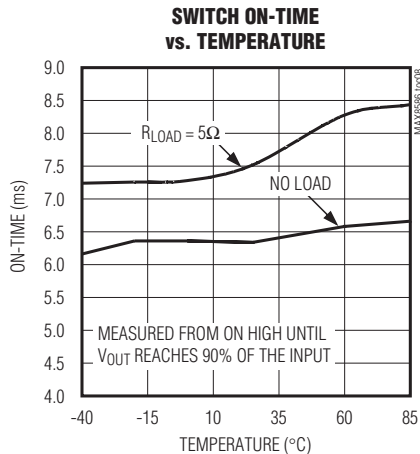
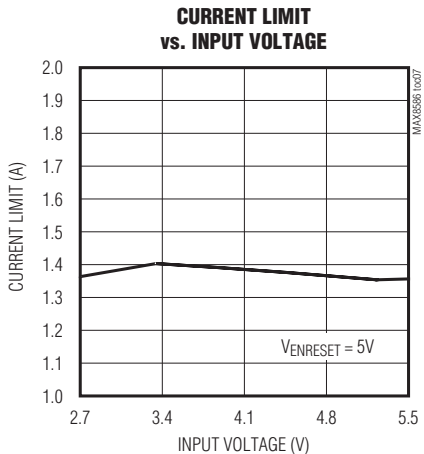
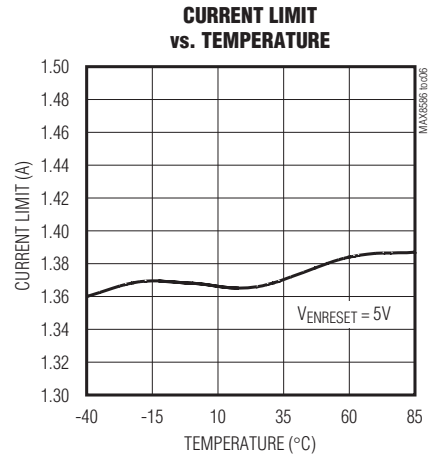
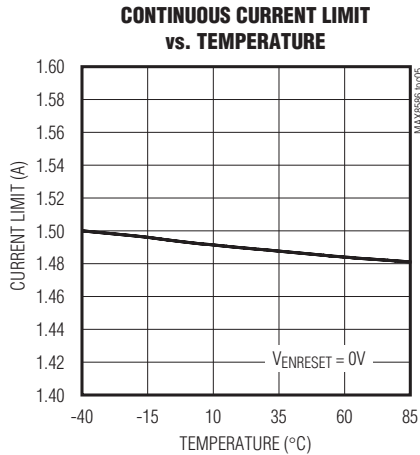
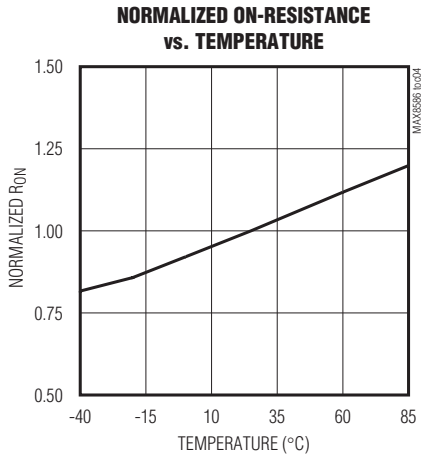
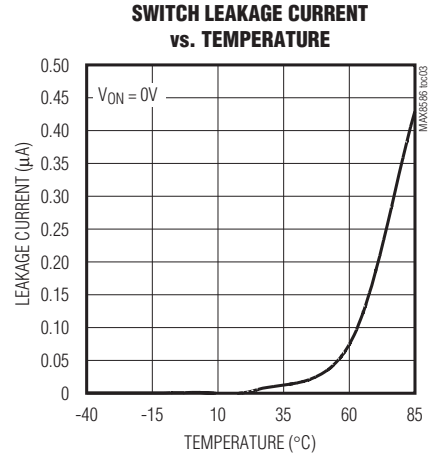
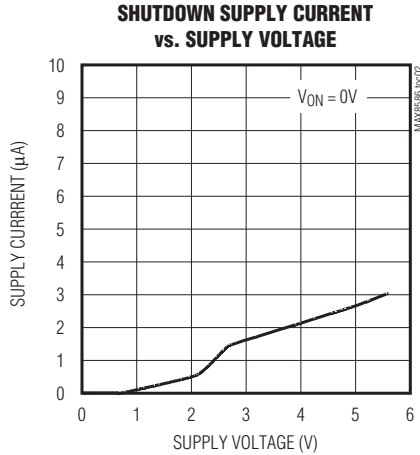
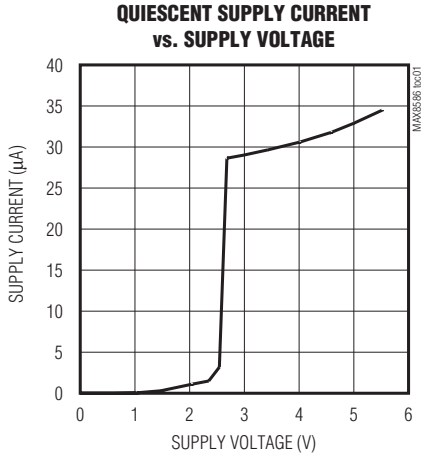

Single 1.2A USB Switch in 3mm x 3mm TDFN

MAX8586

Typical Operating Characteristics (continued)

(Typical Application Circuit, $V_{IN} = V_{ON} = V_{SEL} = V_{ENRESET} = 5V$, $T_A = +25^\circ C$, unless otherwise noted.)

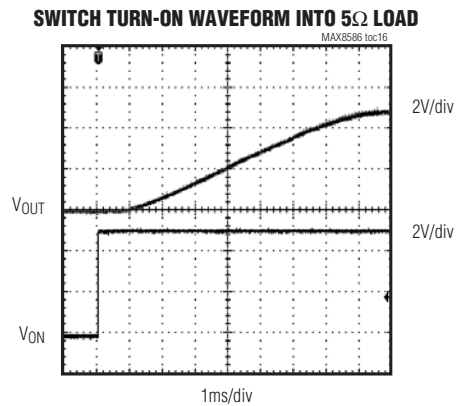
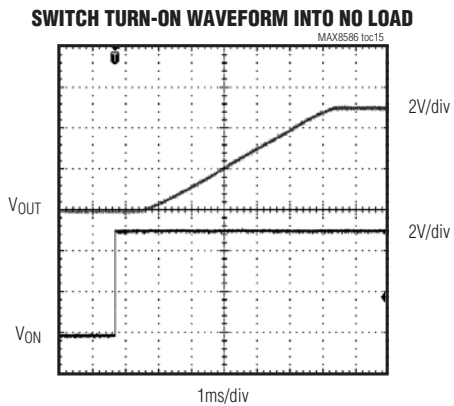
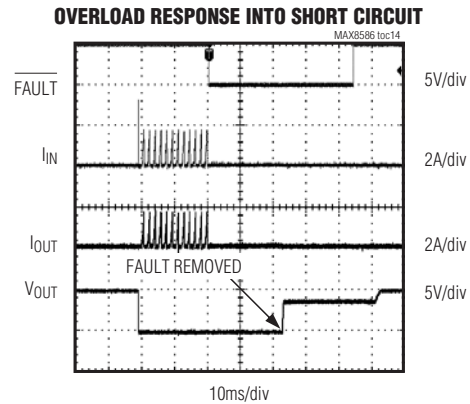
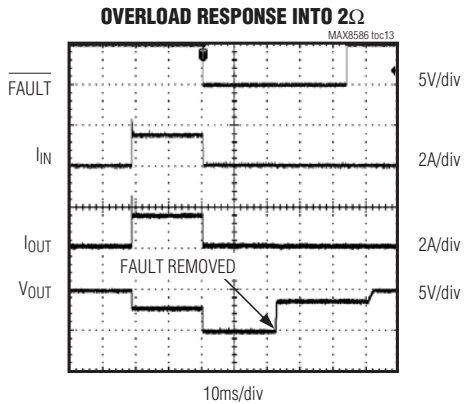
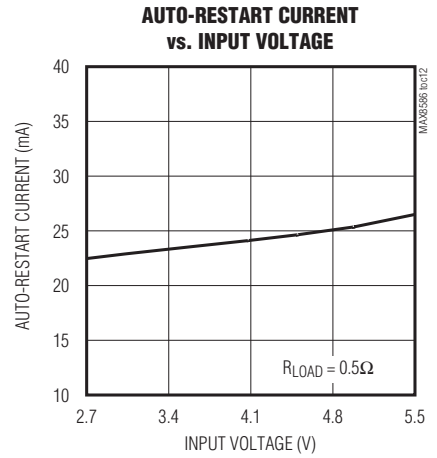
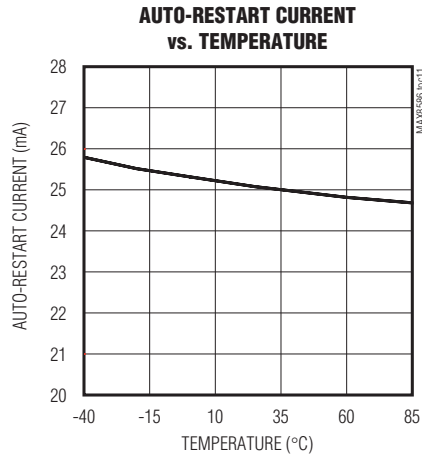
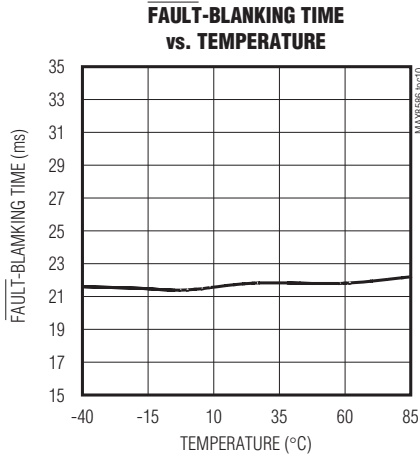

Single 1.2A USB Switch in 3mm x 3mm TDFN

Typical Operating Characteristics (continued)

(Typical Application Circuit, $V_{IN} = V_{ON} = V_{SEL} = V_{ENRESET} = 5V$, $T_A = +25^\circ C$, unless otherwise noted.)

SWITCH TURN-OFF WAVEFORM INTO 5Ω LOAD

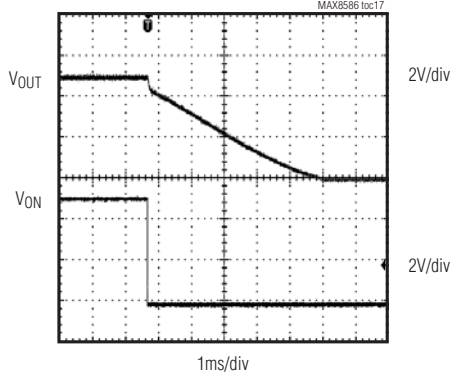

STARTUP INTO $10\mu F$

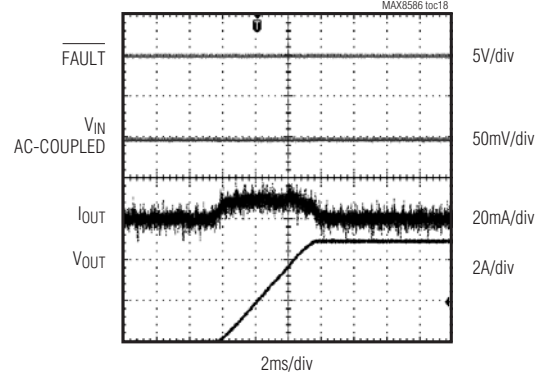

STARTUP INTO $470\mu F$

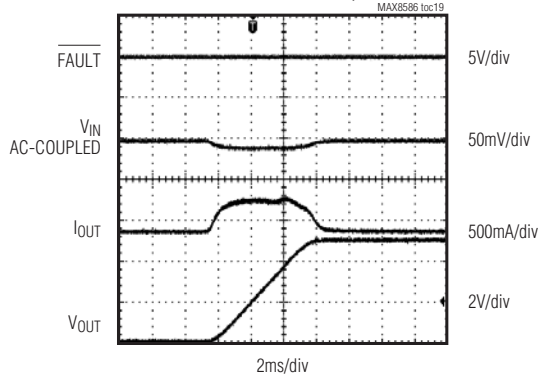

UVLO RESPONSE WITH 50Ω LOAD

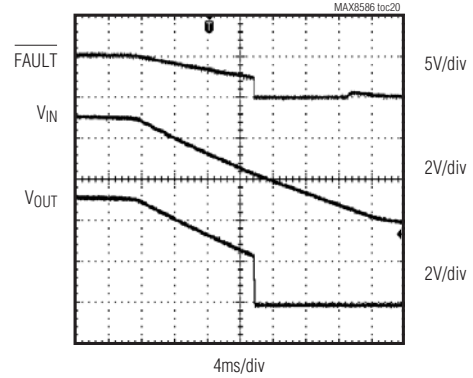

Single 1.2A USB Switch in 3mm x 3mm TDFN

Pin Description

MAX8586

PIN	NAME	FUNCTION
1	SEL	ON Polarity Selector Input. Drive SEL high to select ON for an active-high enable. Drive SEL to GND to select ON for an active-low enable.
2	ISET	Current-Limit Programming Input. Connect a resistor from ISET to GND to set the internal current limit. The valid range for R_{ISET} is 26k Ω to 60k Ω .
3	ON	Enable Input. Drive ON high to enable the device when SEL is high. Drive ON low to enable the device when SEL is low.
4	IN	Power-Supply Input. Connect to an input power supply in the 2.75V to 5.5V range. Bypass IN to GND with a 1 μ F or greater ceramic capacitor.
5	OUT	Power Output. Bypass OUT to GND with a 1 μ F or greater capacitor. OUT is high impedance during shutdown.
6	$\overline{\text{FAULT}}$	Open-Drain Fault-Indicator Output. $\overline{\text{FAULT}}$ is low when the input is below UVLO, or during current limit, reverse current detection, or thermal shutdown.
7	GND	Ground. Connect GND to the exposed paddle and to a ground plane.
8	ENRESET	Auto-Restart Enable Input. Drive ENRESET high to enable auto-restart mode. Drive ENRESET low to disable auto-restart mode.
—	EP	Exposed Pad. Connect the exposed pad to a large ground plane to improve thermal power dissipation.

Functional Diagram

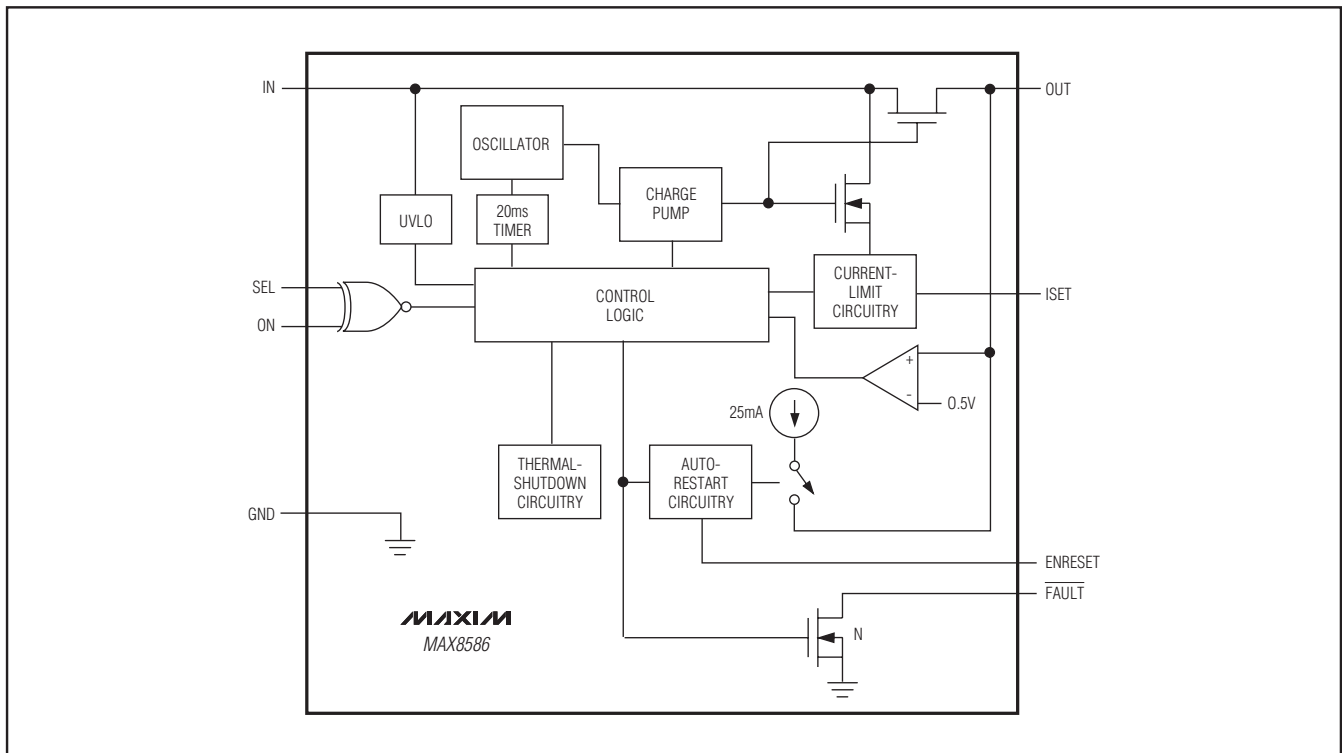

Single 1.2A USB Switch in 3mm x 3mm TDFN

Detailed Description

Current-Limit Protection

The MAX8586 uses two methods to protect the circuit from overcurrent conditions. Continuous current limiting has tighter accuracy but slower response time compared to short-circuit limiting. Combining both methods provides a high degree of protection for a variety of faults. When a current-limit fault occurs with V_{OUT} greater than 1V, the device operates in continuous current-limit mode and limits output current to a user-programmable level. When V_{OUT} is less than 1V, the device operates in short-circuit current-limit mode and pulses the output current to levels that are 30% (typ) higher than the selected continuous current limit.

When either fault condition persists for 20ms (typ), the fault flag is asserted. With the auto-restart enabled (ENRESET high) the output also latches off and is tested with a 25mA current to detect when the fault condition has been removed. 20ms after the fault condition is removed, the output automatically restarts. With the auto-restart disabled (ENRESET low), the output continues to source the current-limit current as long as the fault is present.

Reverse Current Protection

The USB specification does not allow an output device to source current back into the USB port. However, the MAX8586 is designed to safely power noncompliant devices. During normal operation with the channel enabled, if the current from the output to the input exceeds 1A (typ) for more than 20ms (typ), the IC turns off the switch and the FAULT flag is asserted. When the IC is disabled, the output is switched to a high-impedance state, blocking reverse current flow from the output back to the input.

On/Off Control and UVLO

The MAX8586 has a selectable active-high/low ON polarity. Drive SEL high to select an active-high for ON; drive SEL low to select active-low for ON. The MAX8586 includes a UVLO circuit to prevent erroneous switch operation when the input voltage goes low during startup and brownout conditions. Input voltages of less than +2.5V (typ) inhibit operation of the device. FAULT asserts low during a UVLO condition.

Output Fault Protection and Auto-Restart

The MAX8586 uses an auto-restart function to detect short-circuit removal by sourcing 25mA from the output and monitoring the output voltage. When the voltage at

the output exceeds 0.5V for 20ms, the fault flag releases, the output turns back on, and the 25mA current source turns off. Active loads are not expected to draw measurable current when supplied with less than 0.5V. The auto-restart function is enabled when ENRESET is high. Drive ENRESET low to disable the auto-restart function. When the auto-restart function is disabled, OUT regulates the current to the programmed current limit.

Fault Indicator and Fault Blanking

The MAX8586 provides an open-drain output (FAULT) to signal fault conditions. Connect FAULT to IN through a 100k Ω pullup resistor for most applications. FAULT asserts low when any of the following conditions occur:

- The input voltage is below the UVLO threshold.
- The switch junction temperature exceeds the +160°C thermal-shutdown temperature limit.
- The switch is in current-limit or short-circuit current-limit mode for longer than the fault-blanking period (20ms typ).
- The reverse current exceeds the 1A threshold for longer than the fault-blanking period (20ms typ).

When auto-restart is enabled, the FAULT output goes high impedance after a 20ms delay once the fault condition is removed. With auto-restart disabled, during the fault the output is tested every 20ms. When the fault is removed, the FAULT output goes high impedance after a delay that can be up to 20ms. Ensure that the MAX8586 input bypass capacitance prevents glitches from triggering the FAULT output. To distinguish large capacitive loads from short circuits or sustained overloads, the MAX8586 has a fault-blanking circuit. When a load transient causes the output to enter current limit, an internal counter monitors the duration of the fault. For load faults exceeding the 20ms fault-blanking time, the switch turns off, FAULT asserts low, and the output enters auto-restart mode (see the *Current-Limit Protection* and *Output Fault Protection and Auto-Restart* sections). Only current-limit and short-circuit faults are blanked. Thermal-overload faults and input voltages below the UVLO threshold immediately turn the output off and assert FAULT low.

Fault blanking allows the MAX8586 to handle USB loads that might not be fully compliant with USB specifications. The MAX8586 successfully powers USB loads with additional bypass capacitance and/or large start-up currents while protecting the upstream power source. No fault is reported if the switch brings up the load within the 20ms blanking period.

Single 1.2A USB Switch in 3mm x 3mm TDFN

Thermal Shutdown

When the MAX8586 die temperature exceeds +160°C, the switch turns off and $\overline{\text{FAULT}}$ goes low. Thermal shutdown does not utilize the 20ms fault-blanking timeout period. When the junction temperature cools by 15°C, the switch turns on again and $\overline{\text{FAULT}}$ returns high. When an overload condition persists, the switch cycles on and off, resulting in a pulsed output that reduces the average system load.

Applications Information

Setting the Current Limit

A resistor from ISET to ground programs the current-limit value. Use a resistor between 26k Ω and 60k Ω to set the current limit according to the formula:

$$I_{\text{LIM(TYPICAL)}} = 36400 / R_{\text{ISET}} \text{ (Amps)}$$

Do not use R_{ISET} values below 26k Ω because the maximum current rating of the device may be exceeded. R_{ISET} values larger than 60k Ω are not recommended and do not provide a lower limit current than 500mA. If the output drops below 1V (typ), the MAX8586 shifts to a short-circuit current-limit threshold that is 30% above the programmed level given by the $I_{\text{LIM(TYPICAL)}}$ formula.

Input Power Supply and Capacitance

To limit the input voltage drop during momentary output load transients, connect a capacitor from IN to ground. A 1 μF ceramic capacitor is required for local decoupling; however, higher capacitor values further reduce the voltage drop at the input. When driving inductive loads, a larger capacitance may be needed to prevent voltage spikes from exceeding the MAX8586's absolute maximum ratings.

Output Capacitance

A capacitor as large as 500 μF is allowed on the output to smooth out transients and/or increase rise/fall times. Larger output capacitance may be used, but the resulting output charge time during startup may exceed the fault-blanking period resulting in a $\overline{\text{FAULT}}$ flag.

Driving Inductive Loads

A wide variety of devices (mice, keyboards, cameras, and printers) typically connect to the USB port with cables, adding an inductive component to the load. This inductance causes the output voltage at the USB port to oscillate during a load step. The MAX8586 drives inductive loads; however, care must be taken to avoid exceeding the device's absolute maximum ratings. Usually, the load inductance is relatively small, and the MAX8586's input includes a substantial bulk capacitance from an upstream regulator as well as local

bypass capacitors, limiting overshoot. If severe ringing occurs because of large load inductance, clamp the MAX8586 output below +6V and above -0.3V.

Turn-On and Turn-Off Behavior

The MAX8586 features a slow turn-on and turn-off, minimizing loading transients on the upstream power source. SEL sets the active polarity of the logic inputs of the MAX8586. Drive ON to the same logic state as SEL to enable the output. Drive ON to the opposite logic state as SEL to disable the output (see Table 1). The output enters a high-impedance state when disabled.

Table 1. SEL/ON Inputs

SEL	ON	OUT STATE
High	High	Enabled
High	Low	Disabled
Low	High	Disabled
Low	Low	Enabled

Layout and Thermal Dissipation

Keep all input/output traces as short as possible to reduce the effect of undesirable parasitic inductance and optimize the switch response time to output short-circuit conditions. Place input and output capacitors no more than 5mm from device leads. Connect IN and OUT to the power bus with short traces. Wide power bus planes at IN and OUT provide superior heat dissipation as well. An active switch dissipates little power with minimal change in package temperature. Calculate the power dissipation for this condition as follows:

$$P = I_{\text{OUT}}^2 \times R_{\text{ON}}$$

At the normal operating current ($I_{\text{OUT}} = 0.5\text{A}$) and the maximum on-resistance of the switch (95m Ω), the power dissipation is:

$$P = (0.5\text{A})^2 \times 0.095\Omega = 24\text{mW}$$

The worst-case power dissipation occurs when the output current is just below the current-limit threshold with an output voltage greater than 1V. In this case, the power dissipated in the switch is the voltage drop across the switch multiplied by the current limit:

$$P = I_{\text{LIM}} \times (V_{\text{IN}} - V_{\text{OUT}})$$

For a 5.5V input and 1V output, the maximum power dissipation is:

$$P = 1.6\text{A} \times (5.5\text{V} - 1\text{V}) = 7.2\text{W}$$

Single 1.2A USB Switch in 3mm x 3mm TDFN

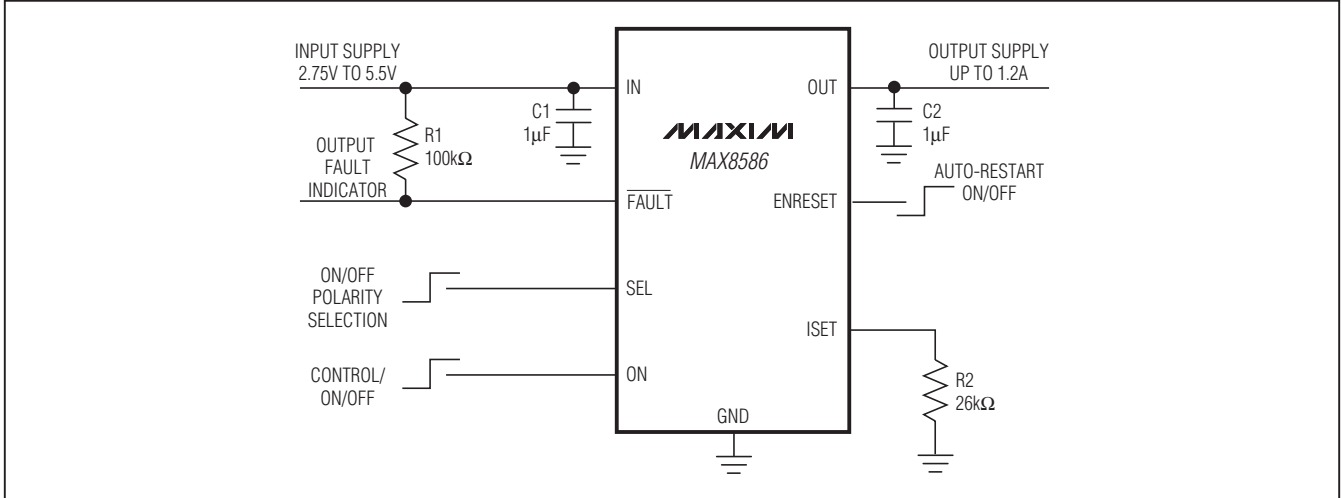

Figure 1. Typical Application Circuit

Because the package power dissipation is 1951mW, the MAX8586 die temperature exceeds the +160°C thermal-shutdown threshold when dissipating 7.2W, and the switch output shuts down until the junction temperature cools by 15°C. The duty cycle and period are strong functions of the ambient temperature and the PC board layout (see the *Thermal Shutdown* section).

If the output current exceeds the current-limit threshold, or the output voltage is pulled below the short-circuit detect threshold, the MAX8586 enters a fault state after 20ms, at which point auto-restart mode is enabled and 25mA is sourced by the output to test for removal of the overload. For a 5V input, OUT short circuited to GND, and auto-restart mode active, the power dissipation is as follows:

$$P = 0.025A \times 5V = 0.125W$$

Pin Configuration

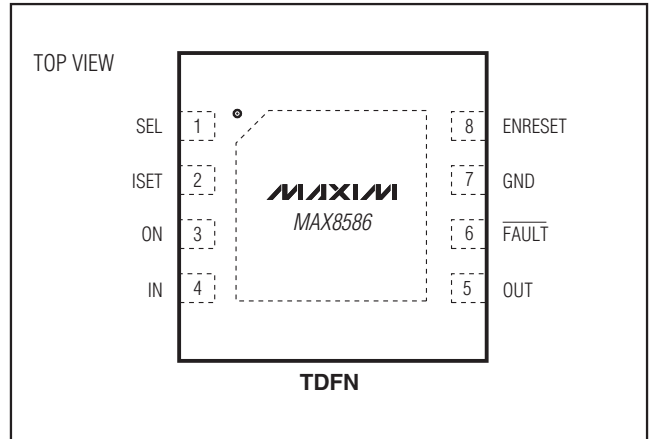

Chip Information

TRANSISTOR COUNT: 2117

PROCESS: BiCMOS

Single 1.2A USB Switch in 3mm x 3mm TDFN

MAX8586

Package Information

For the latest package outline information and land patterns, go to www.maxim-ic.com/packages. Note that a "+", "#", or "-" in the package code indicates RoHS status only. Package drawings may show a different suffix character, but the drawing pertains to the package regardless of RoHS status.

PACKAGE TYPE	PACKAGE CODE	DOCUMENT NO.
8 TQFN-EP	T833-2	21-0137

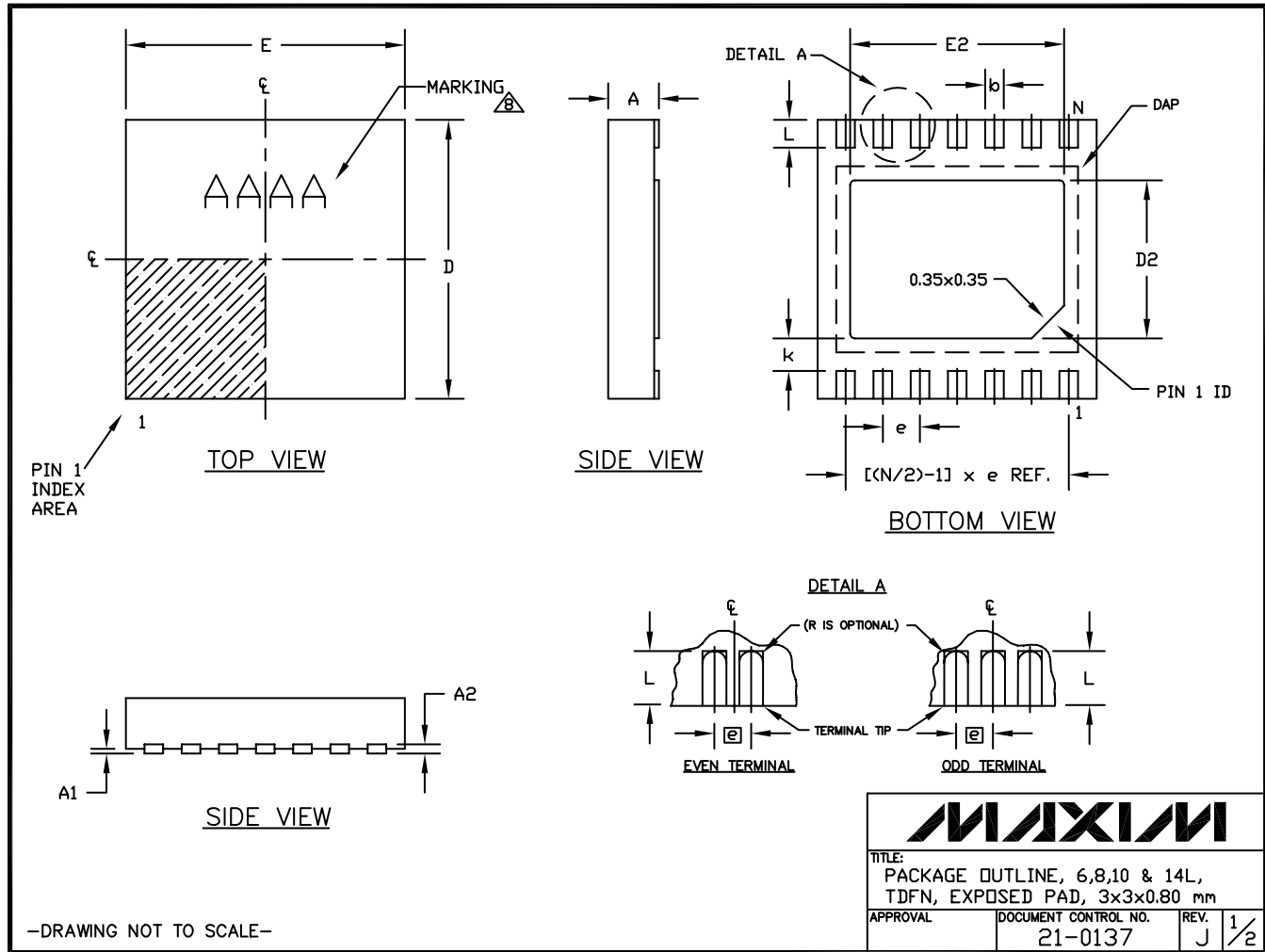

Single 1.2A USB Switch in 3mm x 3mm TDFN

Package Information (continued)

For the latest package outline information and land patterns, go to www.maxim-ic.com/packages. Note that a "+", "#", or "-" in the package code indicates RoHS status only. Package drawings may show a different suffix character, but the drawing pertains to the package regardless of RoHS status.

COMMON DIMENSIONS		
SYMBOL	MIN.	MAX.
A	0.70	0.80
D	2.90	3.10
E	2.90	3.10
A1	0.00	0.05
L	0.20	0.40
k	0.25 MIN.	
A2	0.20 REF.	

PACKAGE VARIATIONS							
PKG. CODE	N	D2	E2	e	JEDEC SPEC	b	[(N/2)-1] x e
T633-2	6	1.50±0.10	2.30±0.10	0.95 BSC	MO229 / WEEA	0.40±0.05	1.90 REF
T833-2	8	1.50±0.10	2.30±0.10	0.65 BSC	MO229 / WEEC	0.30±0.05	1.95 REF
T833-3	8	1.50±0.10	2.30±0.10	0.65 BSC	MO229 / WEEC	0.30±0.05	1.95 REF
T1033-1	10	1.50±0.10	2.30±0.10	0.50 BSC	MO229 / WEED-3	0.25±0.05	2.00 REF
T1033MK-1	10	1.50±0.10	2.30±0.10	0.50 BSC	MO229 / WEED-3	0.25±0.05	2.00 REF
T1033-2	10	1.50±0.10	2.30±0.10	0.50 BSC	MO229 / WEED-3	0.25±0.05	2.00 REF
T1433-1	14	1.70±0.10	2.30±0.10	0.40 BSC	----	0.20±0.05	2.40 REF
T1433-2	14	1.70±0.10	2.30±0.10	0.40 BSC	----	0.20±0.05	2.40 REF
T1433-3F	14	1.70±0.10	2.30±0.10	0.40 BSC	----	0.20±0.05	2.40 REF

NOTES:

- ALL DIMENSIONS ARE IN mm. ANGLES IN DEGREES.
- COPLANARITY SHALL NOT EXCEED 0.08 mm.
- WARPAGE SHALL NOT EXCEED 0.10 mm.
- PACKAGE LENGTH/PACKAGE WIDTH ARE CONSIDERED AS SPECIAL CHARACTERISTIC(S).
- DRAWING CONFORMS TO JEDEC MO229, EXCEPT DIMENSIONS "D2" AND "E2", AND T1433-1 & T1433-2.
- "N" IS THE TOTAL NUMBER OF LEADS.
- NUMBER OF LEADS SHOWN ARE FOR REFERENCE ONLY.
-  MARKING IS FOR PACKAGE ORIENTATION REFERENCE ONLY.
- ALL DIMENSIONS APPLY TO BOTH LEADED (-) AND PbFREE (+) PKG. CODES.

		
TITLE: PACKAGE OUTLINE, 6,8,10 & 14L, TDFN, EXPOSED PAD, 3x3x0.80 mm		
APPROVAL	DOCUMENT CONTROL NO. 21-0137	REV. J 2/2

-DRAWING NOT TO SCALE-

Single 1.2A USB Switch in 3mm x 3mm TDFN

Revision History

REVISION NUMBER	REVISION DATE	DESCRIPTION	PAGES CHANGED
0	11/04	Initial release	—
1	1/09	Added automotive part number	1
2	1/10	Removed UL Listing Pending note, corrected top mark for automotive part, and added soldering temperature (reflow)	1, 2

MAX8586

Maxim cannot assume responsibility for use of any circuitry other than circuitry entirely embodied in a Maxim product. No circuit patent licenses are implied. Maxim reserves the right to change the circuitry and specifications without notice at any time.

Maxim Integrated Products, 120 San Gabriel Drive, Sunnyvale, CA 94086 408-737-7600 _____ 13

© 2010 Maxim Integrated Products

Maxim is a registered trademark of Maxim Integrated Products, Inc.