

Description

The AP2182A and AP2192A are dual channel current-limited integrated high-side power switches optimized for Universal Serial Bus (USB) and other hot-swap applications. The family of devices complies with USB standards and available with both polarities of Enable input.

The devices have fast short-circuit response time for improved overall system robustness, and have integrated output discharge function to ensure completely controlled discharging of the output voltage capacitor. They provide a complete protection solution for application subject to heavy capacitive loads and the prospect of short circuit, and offer reverse current blocking, over-current, over-temperature and short-circuit protection, as well as controlled rise time and under-voltage lockout functionality. A 7ms deglitch capability on the open-drain Flag output prevents false over-current reporting and does not require any external components.

All devices are available in SO-8, MSOP-8-EP and DFN3030E-8 packages.

Features

- Dual channel current-limited power switch with output discharge
- Fast short-circuit response time: 2 μ s
- 2.0A accurate current limiting
- Reverse Current Blocking
- 85m Ω on-resistance
- Input voltage range: 2.7V – 5.5V
- Built-in soft-start with 0.6ms typical rise time
- Short circuit and thermal protection
- Fault report (FLG) with blanking time (7ms typ)
- ESD protection: 2KV HBM, 300V MM
- Active high (AP2192A) or active low (AP2182A) enable
- Ambient temperature range: -40 $^{\circ}$ C to 85 $^{\circ}$ C
- SO-8, MSOP-8-EP and DFN3030E-8 (Exposed Pad): Available in "Green" Molding Compound (No Br, Sb)
- Lead Free Finish/ RoHS Compliant (Note 1)
- UL Recognized, File Number E322375
- IEC60950-1 CB Scheme Certified

Applications

- LCD TVs & Monitors
- Set-Top-Boxes, Residential Gateways
- Laptops, Desktops, Servers,
- Printers, Docking Stations, HUBs

Notes: 1. EU Directive 2002/95/EC (RoHS). All applicable RoHS exemptions applied. Please visit our website at http://www.diodes.com/products/lead_free.html.

Pin Assignments

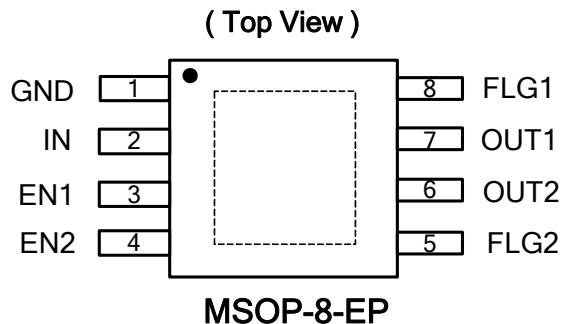

Typical Application Circuit

AP2192 A Enable Active High

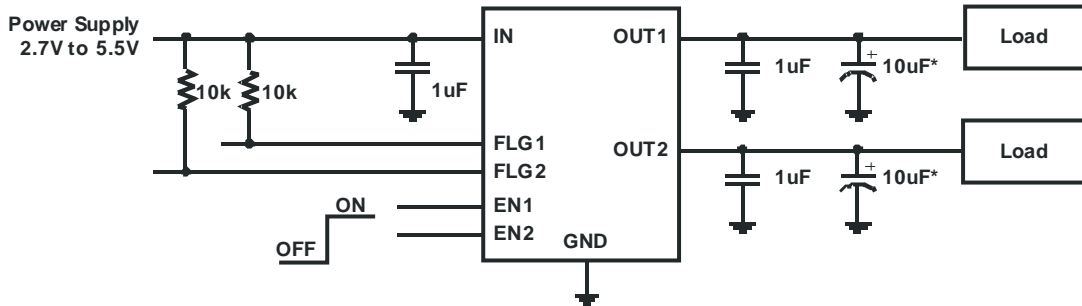

Note: * USB 2.0 requires 120uF per hub

Available Options

| Part Number | Channel | Enable pin (EN) | Current limit (typical) | Recommended maximum continuous load current |
|-------------|---------|-----------------|-------------------------|---|
| AP2182A | 2 | Active Low | 2.0A | 1.5A |
| AP2192A | 2 | Active High | 2.0A | 1.5A |

Pin Descriptions

| Pin Name | Pin Number | Descriptions |
|-------------|------------|--|
| GND | 1 | Ground |
| IN | 2 | Voltage input pin |
| EN1 | 3 | Switch 1 enable input, active low (AP2182A) or active high (AP2192A) |
| EN2 | 4 | Switch 2 enable input, active low (AP2182A) or active high (AP2192A) |
| FLG2 | 5 | Switch 2 over-current and over-temperature fault report; open-drain flag is active low when triggered |
| OUT2 | 6 | Switch 2 voltage output pin |
| OUT1 | 7 | Switch 1 voltage output pin |
| FLG1 | 8 | Switch 1 over-current and over-temperature fault report; open-drain flag is active low when triggered |
| Exposed Pad | - | Internally connected to GND; recommend connecting to the GND externally for improved power dissipation |

Functional Block Diagram

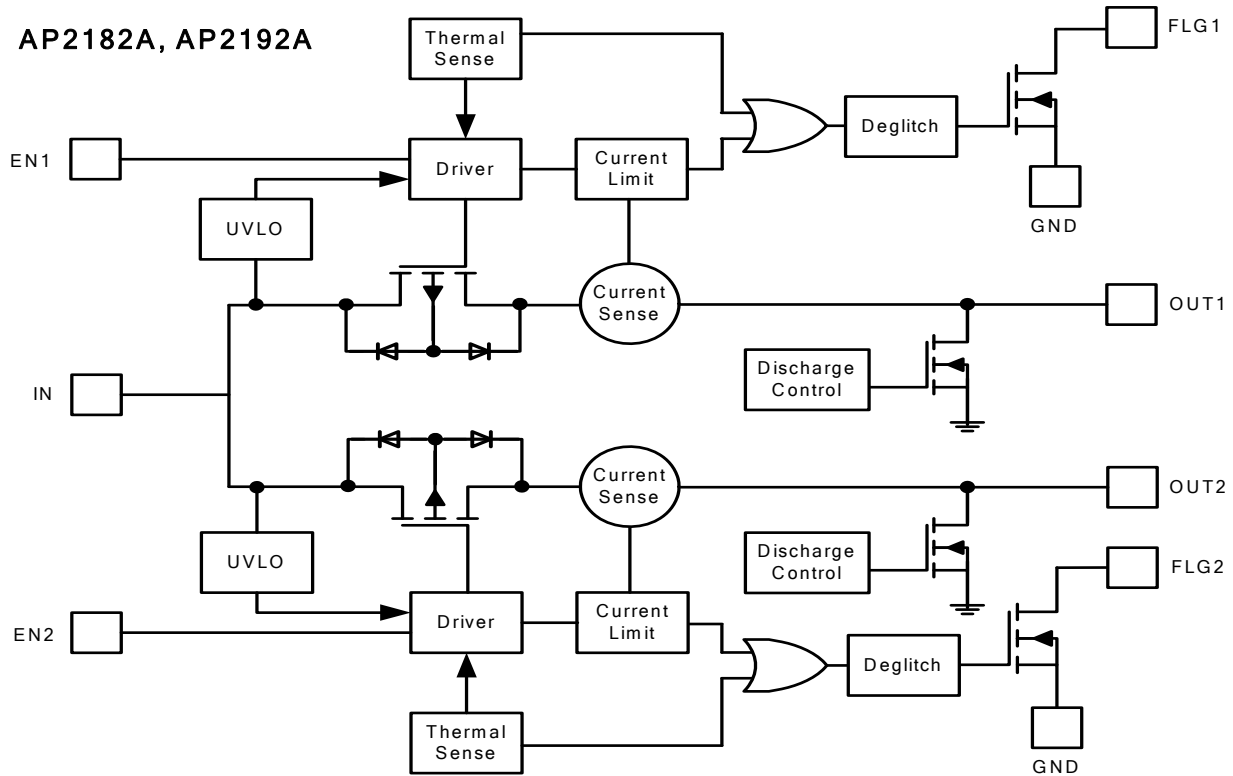

Absolute Maximum Ratings

| Symbol | Parameter | Ratings | Units |
|-------------------|------------------------------------|------------------|-------|
| ESD HBM | Human Body Model ESD Protection | 2 | KV |
| ESD MM | Machine Model ESD Protection | 300 | V |
| V_{IN} | Input Voltage | 6.5 | V |
| V_{OUT} | Output Voltage | $V_{IN} + 0.3$ | V |
| V_{EN}, V_{FLG} | Enable Voltage | 6.5 | V |
| I_{load} | Maximum Continuous Load Current | Internal Limited | A |
| T_{Jmax} | Maximum Junction Temperature | 150 | °C |
| T_{ST} | Storage Temperature Range (Note 2) | -65 to 150 | °C |

Notes: 2. UL Recognized Rating from -30°C to 70°C (Diodes qualified T_{ST} from -65°C to 150°C)

Recommended Operating Conditions

| Symbol | Parameter | Min | Max | Units |
|-----------|-------------------------------|-----|-----|-------|
| V_{IN} | Input voltage | 2.7 | 5.5 | V |
| I_{OUT} | Output Current | 0 | 1.5 | A |
| T_A | Operating Ambient Temperature | -40 | 85 | °C |

Electrical Characteristics ($T_A = 25^\circ\text{C}$, $V_{IN} = +5.0\text{V}$, unless otherwise stated)

| Symbol | Parameter | Test Conditions (Note 3) | Min | Typ. | Max | Unit | |
|----------------|---|---|--------------------------|------|-----|---------------|--------------------|
| V_{UVLO} | Input UVLO | | 1.6 | 2.0 | 2.4 | V | |
| I_{SHDN} | Input Shutdown Current | Disabled, $I_{OUT} = 0$ | | 0.1 | 1 | μA | |
| I_Q | Input Quiescent Current, Dual | Enabled, $I_{OUT} = 0$ | | 115 | 180 | μA | |
| I_{LEAK} | Input Leakage Current | Disabled, OUT grounded | | | 1 | μA | |
| I_{REV} | Reverse Leakage Current | Disabled, $V_{IN} = 0\text{V}$, $V_{OUT} = 5\text{V}$, I_{REV} at V_{IN} | | 0.01 | 0.1 | μA | |
| $R_{DS(ON)}$ | Switch on-resistance | $V_{IN} = 5\text{V}$, $I_{OUT} = 1.5\text{A}$, $T_A = 25^\circ\text{C}$ | | 90 | 110 | m Ω | |
| | | | SO-8 | | | | |
| | | | MSOP-8-EP, DFN3030E-8 | | 85 | | 105 |
| | | $V_{IN} = 5\text{V}$, $I_{OUT} = 1.5\text{A}$, $-40^\circ\text{C} \leq T_A \leq 85^\circ\text{C}$ | | | | | 135 |
| | | $V_{IN} = 3.3\text{V}$, $I_{OUT} = 1.5\text{A}$, $T_A = 25^\circ\text{C}$ | | | 110 | | 130 |
| | | SO-8 | | | | | |
| | | MSOP-8-EP, DFN3030E-8 | | 105 | 125 | | |
| | | $V_{IN} = 3.3\text{V}$, $I_{OUT} = 1.5\text{A}$, $-40^\circ\text{C} \leq T_A \leq 85^\circ\text{C}$ | | | | 170 | |
| I_{LIMIT} | Over-Load Current Limit | $V_{IN} = 5\text{V}$, $V_{OUT} = 4.0\text{V}$, $C_L = 10\mu\text{F}$ | | 1.6 | 2.0 | 2.4 | A |
| | | $-40^\circ\text{C} \leq T_A \leq 85^\circ\text{C}$ | | | | | |
| I_{LIMIT_G} | Ganged Over-Load Current Limit | $V_{IN} = 5\text{V}$, $V_{OUT} = 4.6\text{V}$, OUT1 & OUT2 tied together, $C_L = 10\mu\text{F}$ | | 3.2 | 4.0 | 4.8 | A |
| | | $-40^\circ\text{C} \leq T_A \leq 85^\circ\text{C}$ | | | | | |
| I_{Trig} | Current limiting trigger threshold | Output Current Slew rate ($<100\text{A/s}$), $C_L = 10\mu\text{F}$ | | 2.5 | | | A |
| I_{Trig_G} | Ganged current limiting trigger threshold | OUT1 & OUT2 tied together, Output Current Slew rate ($<100\text{A/s}$), $C_L = 10\mu\text{F}$ | | 5.0 | | | A |
| I_{OS} | Short-circuit current per channel | OUTx connected to ground, device enabled into short circuit, $C_L = 10\mu\text{F}$ | | 2.0 | | | A |
| I_{OS_G} | Ganged short-circuit current | OUT1 & OUT2 connected to ground, device enabled into short-circuit, $C_L = 10\mu\text{F}$ | 3.2 | 4.0 | 4.8 | | A |
| T_{SHORT} | Short-circuit response time | $V_{OUT} = 0\text{V}$ to $I_{OUT} = I_{LIMIT}$ (output shorted to ground) | | 2 | | | μs |
| V_{IL} | EN Input Logic Low Voltage | $V_{IN} = 2.7\text{V}$ to 5.5V | | | 0.8 | | V |
| V_{IH} | EN Input Logic High Voltage | $V_{IN} = 2.7\text{V}$ to 5.5V | 2 | | | | V |
| I_{SINK} | EN Input leakage | $V_{EN} = 0\text{V}$ to 5.5V | | | 1 | | μA |
| I_{LEAK-O} | Output leakage current | Disabled, $V_{OUT} = 0\text{V}$ | | 0.5 | 1 | | μA |
| T_R | Output turn-on rise time | $C_L = 1\mu\text{F}$, $R_{load} = 5\Omega$ | | 0.6 | 1.5 | | ms |
| T_F | Output turn-off fall time | $C_L = 1\mu\text{F}$, $R_{load} = 5\Omega$ | | 0.05 | 0.3 | | ms |
| $T_{D(ON)}$ | Output turn-on delay time | $C_L = 100\mu\text{F}$, $R_{load} = 5\Omega$ | | 0.2 | 0.5 | | ms |
| $T_{D(OFF)}$ | Output turn-off delay time | $C_L = 100\mu\text{F}$, $R_{load} = 5\Omega$ | | 0.1 | 0.3 | | ms |
| R_{FLG} | FLG output FET on-resistance | $I_{FLG} = 10\text{mA}$ | | 20 | 40 | | Ω |
| I_{FOH} | FLG off current | $V_{FLG} = 5\text{V}$ | | 0.01 | 1 | | μA |
| T_{Blank} | FLG blanking time | $C_L = 10\mu\text{F}$ | 4 | 7 | 15 | | ms |
| R_{DIS} | Discharge resistance (Note 4) | $V_{IN} = 5\text{V}$, disabled, $I_{OUT} = 1\text{mA}$ | | 100 | | | Ω |
| T_{SHDN} | Thermal shutdown threshold | Enabled, $R_{load} = 1\text{k}\Omega$ | | 140 | | | $^\circ\text{C}$ |
| T_{HYS} | Thermal shutdown hysteresis | | | 25 | | | $^\circ\text{C}$ |
| θ_{JA} | Thermal Resistance Junction-to-Ambient | SO-8 (Note 5) | | 115 | | | $^\circ\text{C/W}$ |
| | | MSOP-8-EP (Note 6) | | 75 | | | |
| | | DFN3030E-8 (Note 6) | | 60 | | | |

- Notes:
- Pulse-testing techniques maintain junction temperature close to ambient temperature; thermal effects must be taken into account separately.
 - The discharge function is active when the device is disabled (when enable is de-asserted or during power-up power-down when $V_{IN} < V_{UVLO}$). The discharge function offers a resistive discharge path for the external storage capacitor for limited time.
 - Test condition for SO-8: Device mounted on FR-4 substrate PCB with minimum recommended pad layout.
 - Test condition for MSOP-8-EP and DFN3030E-8: Device mounted on 2" x 2" FR-4 substrate PCB, 2oz copper, with minimum recommended pad on top layer and thermal vias to bottom layer ground plane.

Typical Performance Characteristics

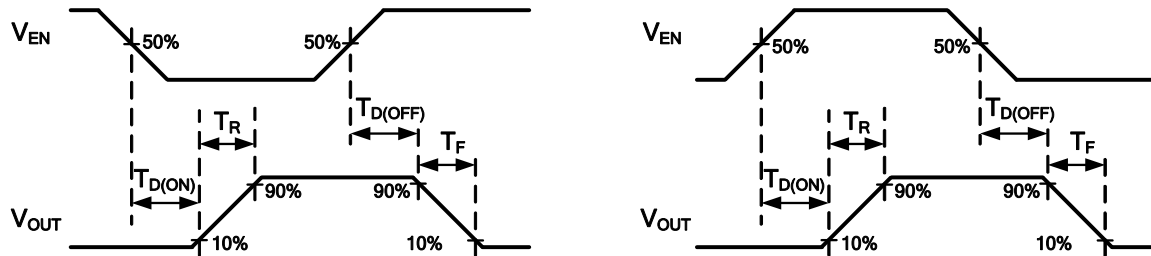

Figure 1. Voltage Waveforms: AP2182A (left), AP2192A (right)

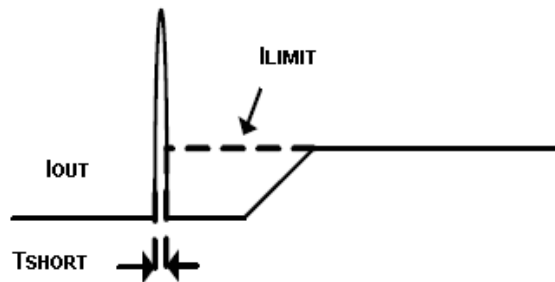
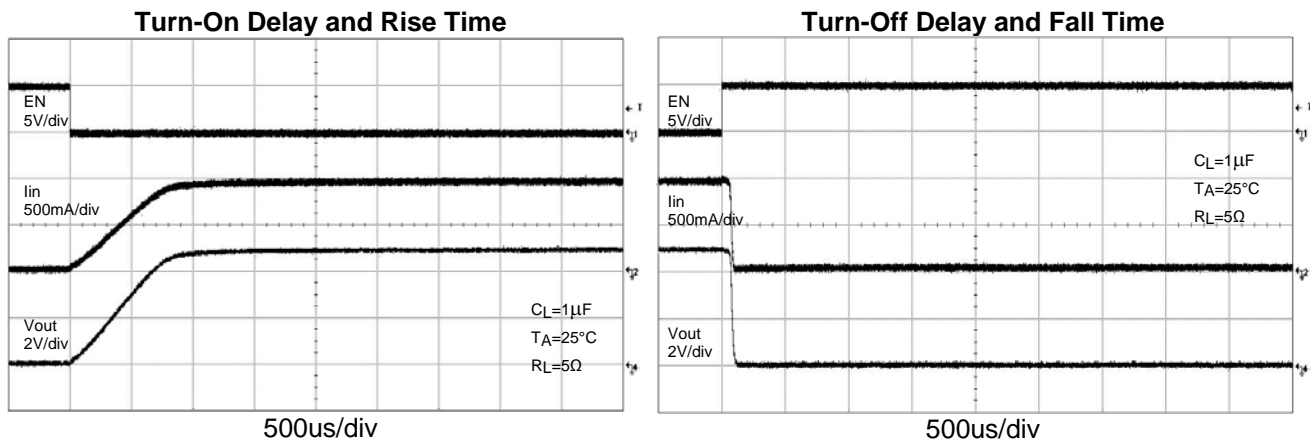

Figure 2. Response Time to Short Circuit Waveform

All Enable Plots are for AP2182A Active Low



Typical Performance Characteristics (Continued)

Turn-On Delay and Rise Time

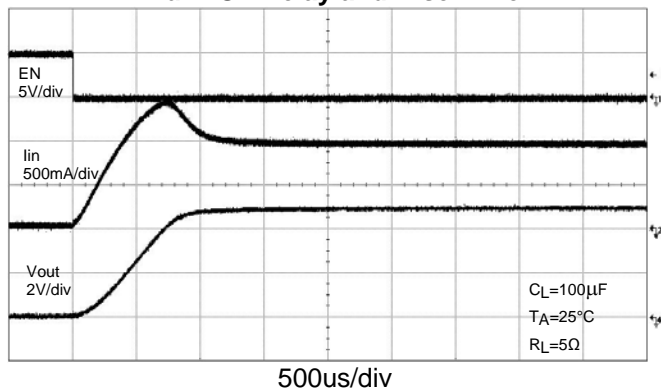

Turn-Off Delay and Fall Time

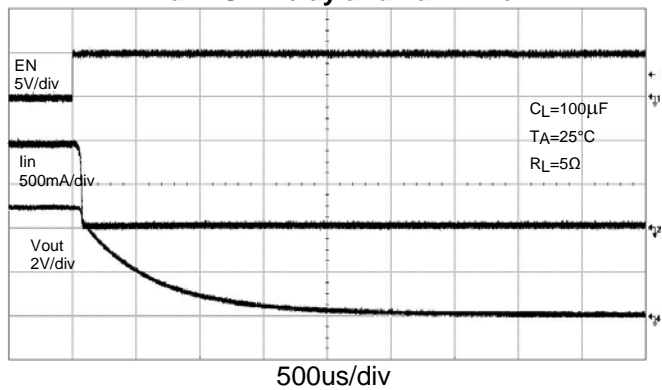

Short Circuit Current, Device Enabled Into Short

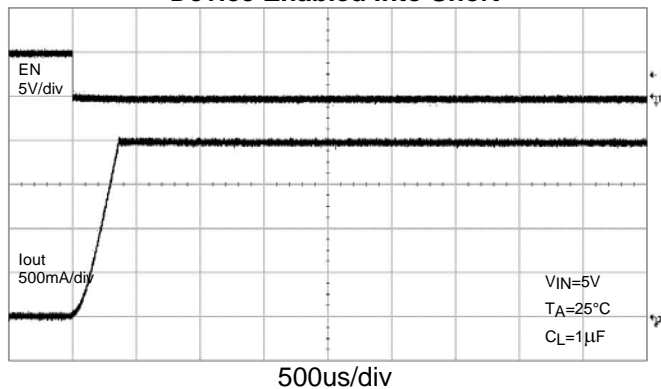

Inrush Current with Different Load Capacitance

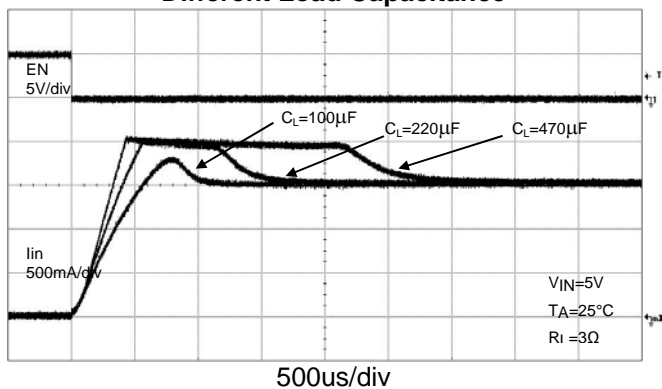

1 Ω Load Connected to Enabled Device

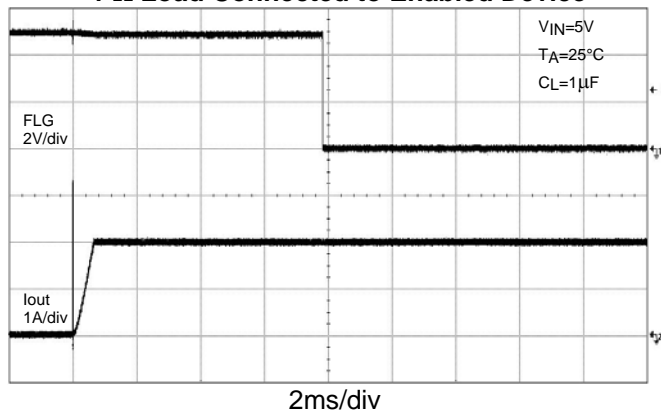

0.6 Ω Load Connected to Enabled Device

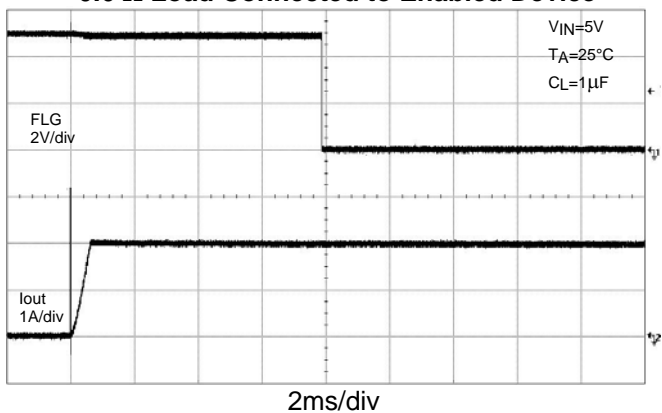

NEW PRODUCT

Typical Performance Characteristics (Continued)

Short Circuit with Blanking Time and Recovery

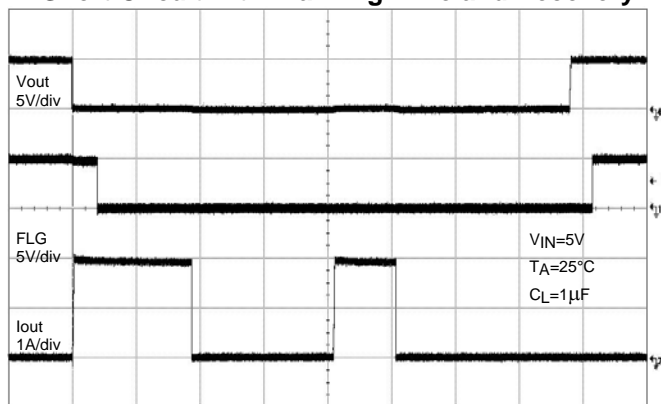

20ms/div

Power On

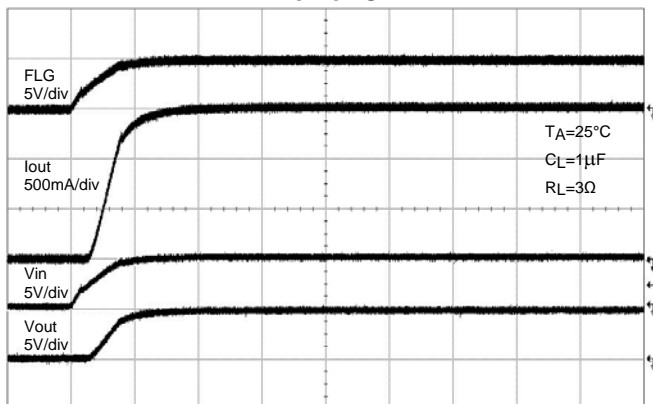

1ms/div

Power Off

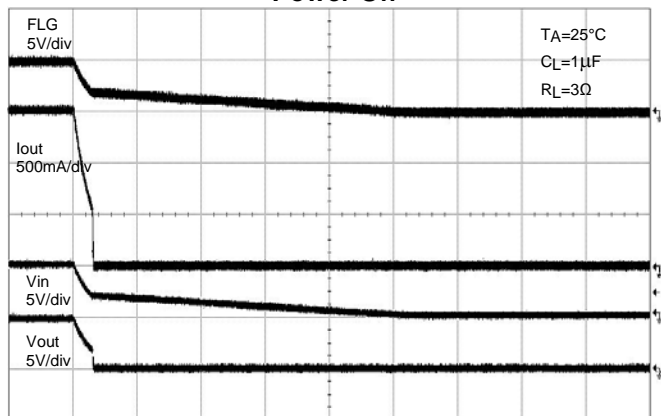

10ms/div

Device Enabled

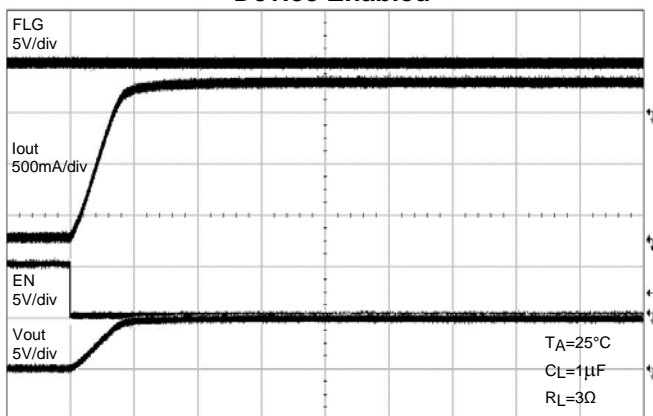

1ms/div

Device Disabled

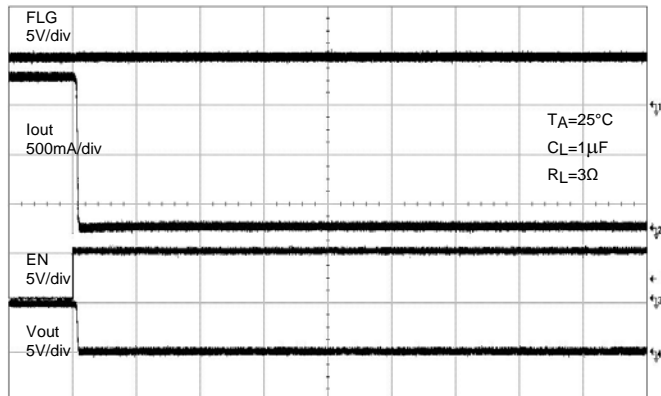

1ms/div

UVLO Increasing

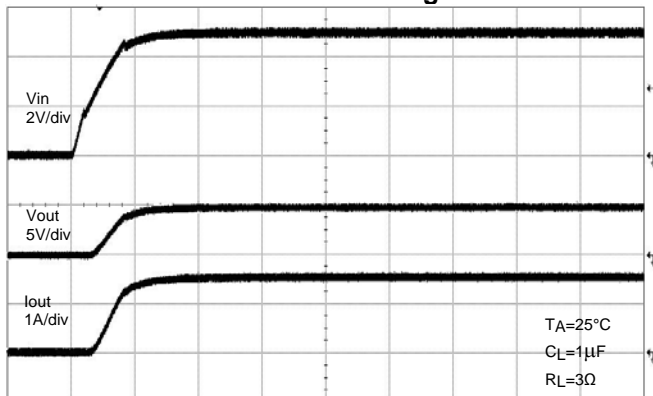

1ms/div

NEW PRODUCT

Typical Performance Characteristics (Continued)

UVLO Decreasing

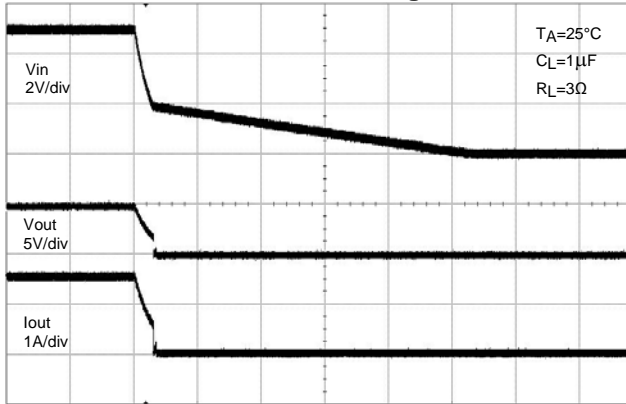

10ms/div

UVLO Increasing (No Load)

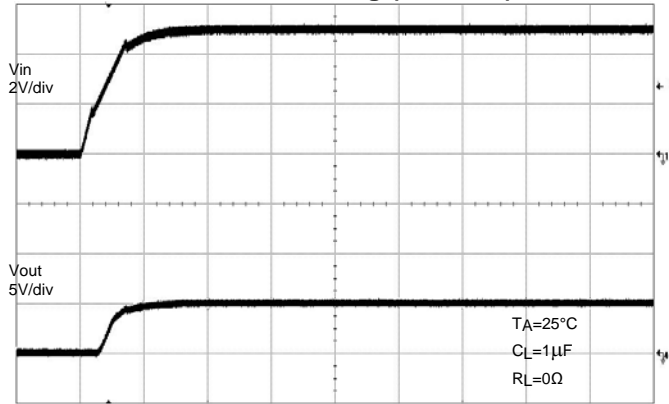

1ms/div

UVLO Decreasing (No Load)

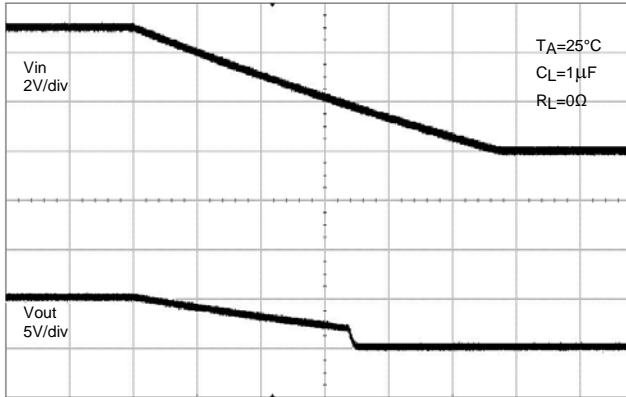

20ms/div

Channel 1 Enabled and Shorted with Channel 2 Enabled

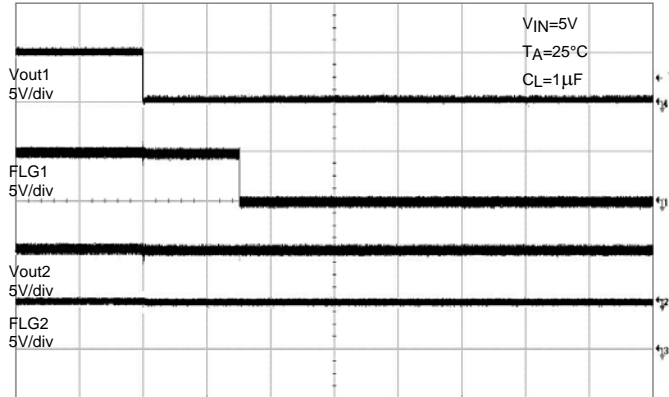

5ms/div

Channel 2 Enabled and Shorted with Channel 1 Enabled

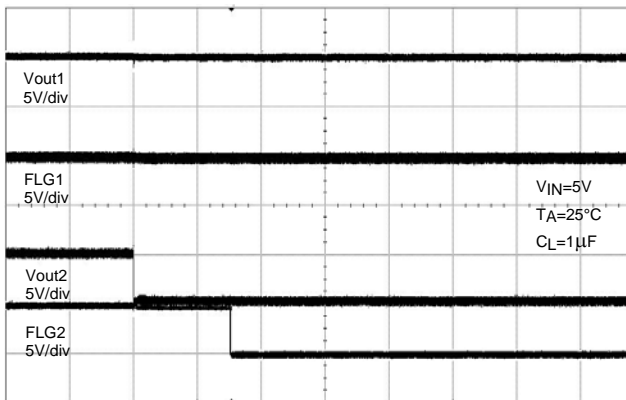

5ms/div

Channels 1 and 2 Enabled and Shorted

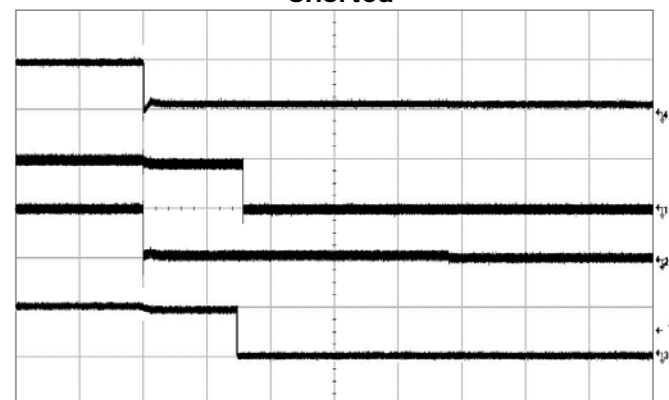

5ms/div

Typical Performance Characteristics (Continued)

NEW PRODUCT

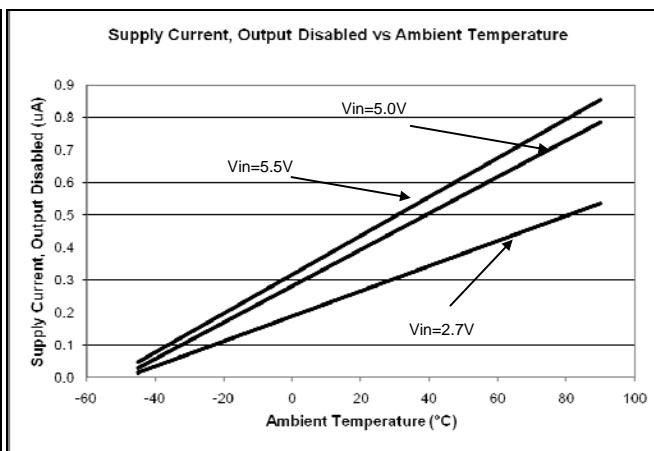
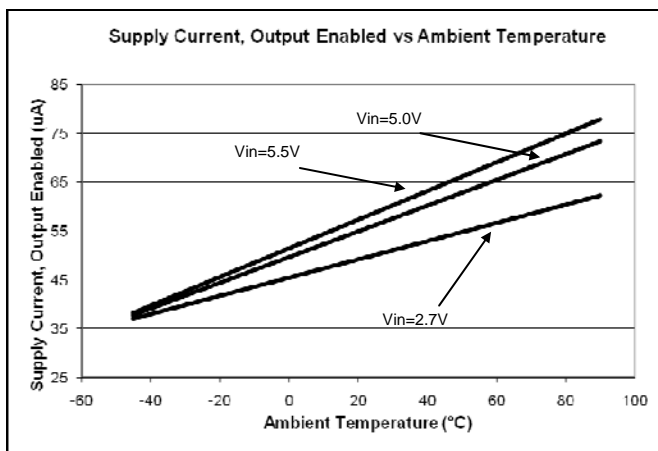
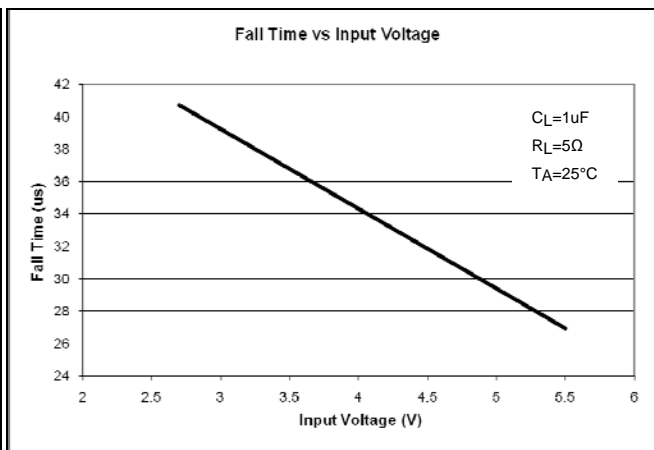
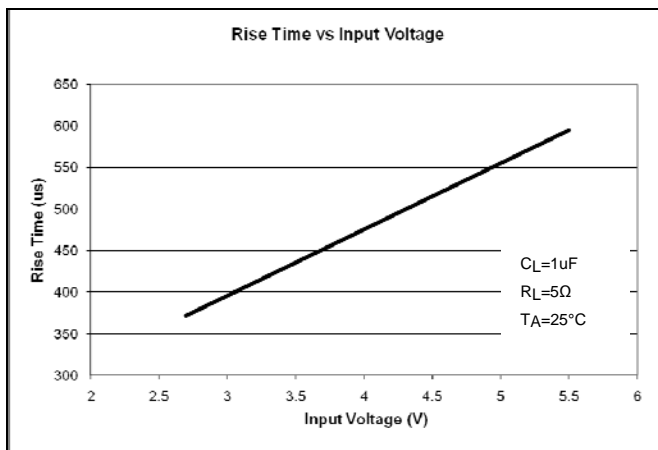
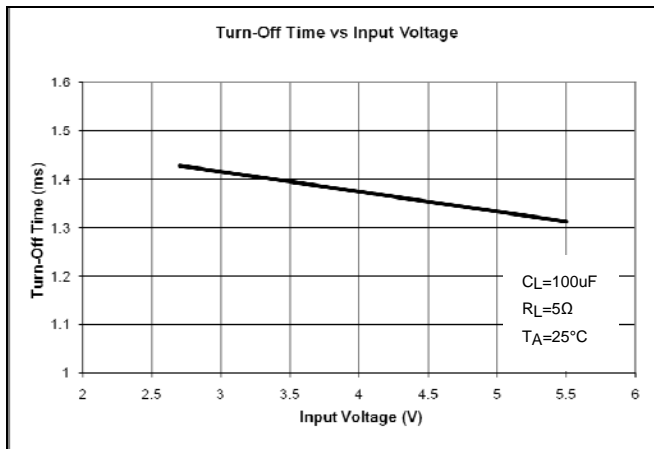
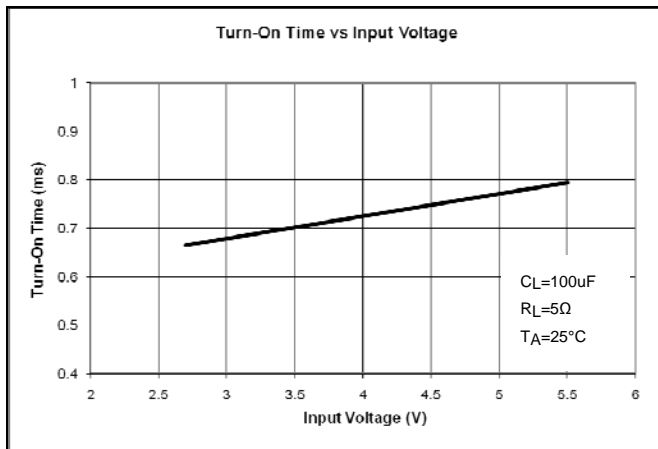

Typical Performance Characteristics (Continued)

NEW PRODUCT

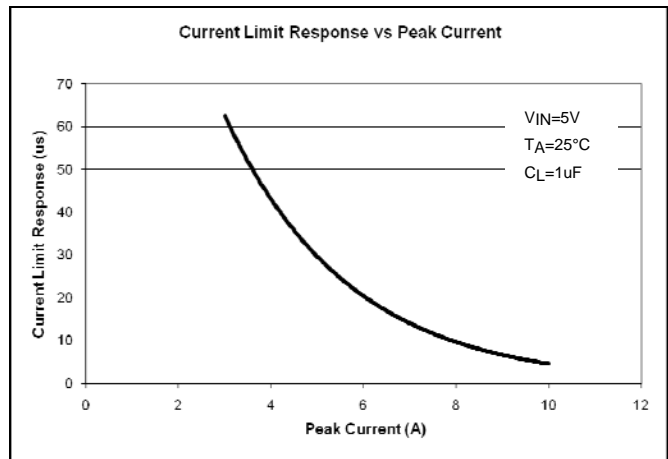
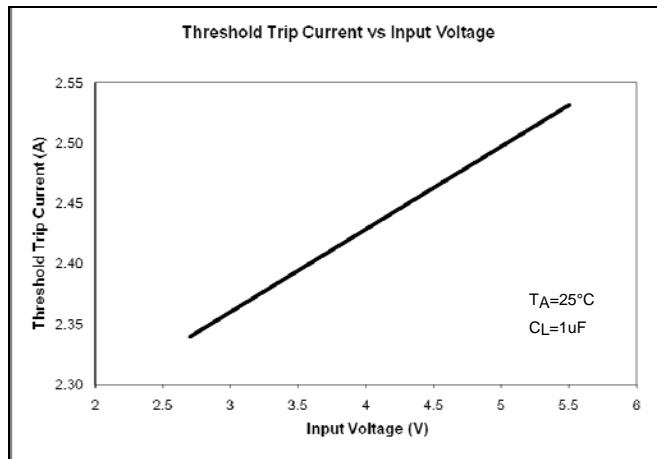
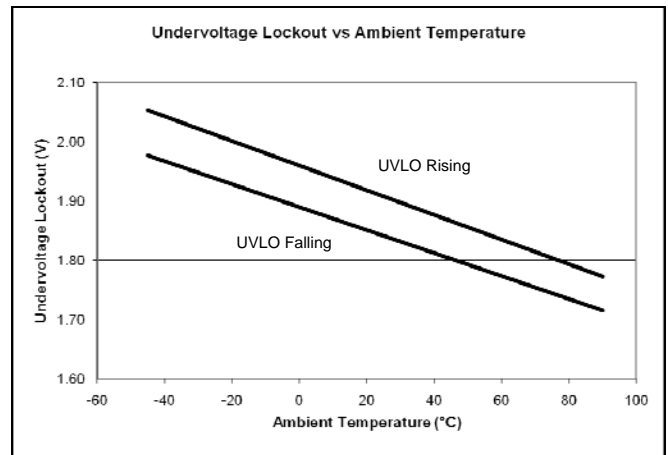
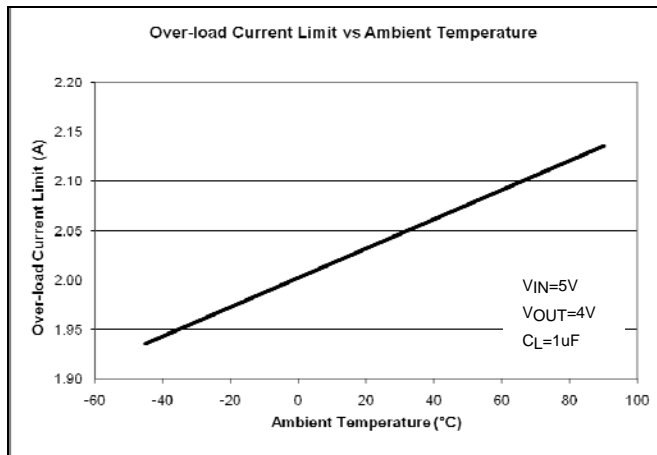
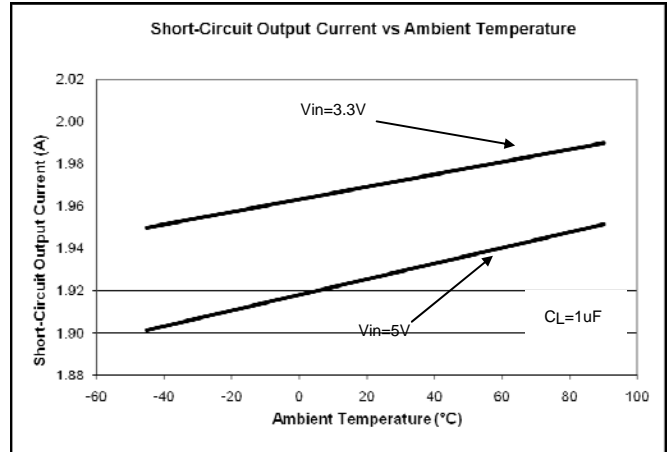
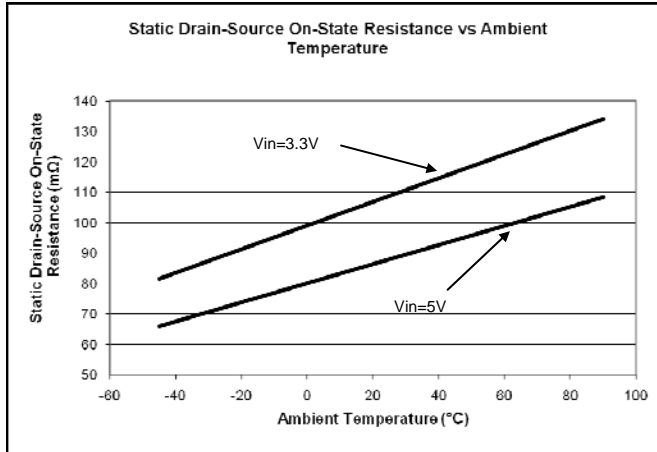

Application Note

Power Supply Considerations

A 0.1µF to 1µF X7R or X5R ceramic bypass capacitor between IN and GND, close to the device, is recommended. Placing a high-value electrolytic capacitor on the input and output pin(s) is recommended when the output load is heavy. This precaution reduces power-supply transients that may cause ringing on the input. Additionally, bypassing the output with a 1µF ceramic capacitor improves the immunity of the device to short-circuit transients.

Over-current and Short Circuit Protection

An internal sensing FET is employed to check for over-current conditions. Unlike current-sense resistors, sense FETs do not increase the series resistance of the current path. When an overcurrent condition is detected, the device maintains a constant output current and reduces the output voltage accordingly. Complete shutdown occurs only if the fault stays long enough to activate thermal limiting.

Three possible overload conditions can occur. In the first condition, the output has been shorted to GND before the device is enabled or before V_{IN} has been applied. The AP2182A/AP2192A senses the short circuit and immediately clamps output current to a certain safe level namely I_{LIMIT} .

In the second condition, an output short or an overload occurs while the device is enabled. At the instance the overload occurs, higher inrush current may flow for a very short period of time before the current limit function can react. The input capacitor(s) rapidly discharge through the device, activating current limit circuitry. Protection is achieved by momentarily opening the P-MOS high-side power switch and then gradually turning it on. After the current limit function has tripped (reached the over-current trip threshold), the device switches into current limiting mode and the current is clamped at I_{LIMIT} . The threshold for activating current limiting is 2A typical per channel.

In the third condition, the load has been gradually increased beyond the recommended operating current. The current is permitted to rise until the current-limit threshold (I_{TRIG}) is reached or until the thermal limit of the device is exceeded. The AP2182A/AP2192A is capable of delivering current up to the current-limit threshold without damaging the device. Once the threshold has been reached, the device switches into its current limiting mode and is set at I_{LIMIT} .

FLG Response

When an over-current or over-temperature shutdown condition is encountered, the FLG open-drain output goes active low after a nominal 7-ms deglitch timeout. The FLG output remains low until both over-current and over-temperature conditions are removed. Connecting a heavy capacitive load to the output of the device can cause a momentary over-current condition, which does not trigger the FLG due to the 7-ms deglitch timeout. The AP2182A/AP2192A is designed to eliminate false over-current reporting without the need of external components to remove unwanted pulses.

Power Dissipation and Junction Temperature

The low on-resistance of the internal MOSFET allows the small surface-mount packages to pass large current. Using the maximum operating ambient temperature (T_A) and $R_{DS(ON)}$, the power dissipation can be calculated by:

$$P_D = R_{DS(ON)} \times I^2$$

Finally, calculate the junction temperature:

$$T_J = P_D \times R_{\theta JA} + T_A$$

Where:

T_A = Ambient temperature °C

$R_{\theta JA}$ = Thermal resistance

P_D = Total power dissipation

Application Note (Continued)

Thermal Protection

Thermal protection prevents the IC from damage when heavy-overload or short-circuit faults are present for extended periods of time. The AP2182A/AP2192A implements a thermal sensing to monitor the operating junction temperature of the power distribution switch. Once the die temperature rises to approximately 140°C due to excessive power dissipation in an over-current or short-circuit condition the internal thermal sense circuitry turns the power switch off, thus preventing the power switch from damage. Hysteresis is built into the thermal sense circuit allowing the device to cool down approximately 25°C before the switch turns back on. The switch continues to cycle in this manner until the load fault or input power is removed. The FLG open-drain output is asserted when an over-temperature shutdown or over-current occurs with 7-ms deglitch.

Under-voltage Lockout (UVLO)

Under-voltage lockout function (UVLO) keeps the internal power switch from being turned on until the power supply has reached at least 2V, even if the switch is enabled. Whenever the input voltage falls below approximately 2V, the power switch is quickly turned off. This facilitates the design of hot-insertion systems where it is not possible to turn off the power switch before input power is removed.

Discharge Function

The discharge function of the device is active when enable is disabled or de-asserted. The discharge function with the N-MOS power switch implementation is activated and offers a resistive discharge path for the external storage capacitor. This is designed for discharging any residue of the output voltage when either no external output resistance or load resistance is present at the output.

Host/Self-Powered HUBs

Hosts and self-powered hubs (SPH) have a local power supply that powers the embedded functions and the downstream ports. This power supply must provide from 5.25V to 4.75V to the board side of the downstream connection under both full-load and no-load conditions. Hosts and SPHs are required to have current-limit protection and must report over-current conditions to the USB controller. Typical SPHs are desktop PCs, monitors, printers, and stand-alone hubs.

Generic Hot-Plug Applications

In many applications it may be necessary to remove modules or pc boards while the main unit is still operating. These are considered hot-plug applications. Such implementations require the control of current surges seen by the main power supply and the card being inserted. The most effective way to control these surges is to limit and slowly ramp the current and voltage being applied to the card, similar to the way in which a power supply normally turns on. Due to the controlled rise times and fall times of the AP2182A/AP2192A, these devices can be used to provide a softer start-up to devices being hot-plugged into a powered system. The UVLO feature of the AP2182A/AP2192A also ensures that the switch is off after the card has been removed, and that the switch is off during the next insertion.

By placing the AP2182A/AP2192A between the Vcc input and the rest of the circuitry, the input power reaches these devices first after insertion. The typical rise time of the switch is approximately 1ms, providing a slow voltage ramp at the output of the device. This implementation controls system surge current and provides a hot-plugging mechanism for any device.

Ordering Information

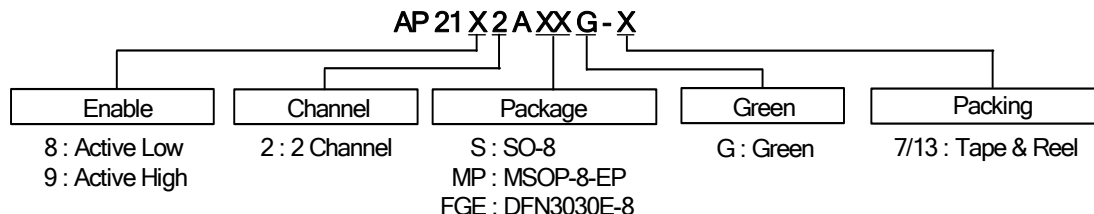

| Device | Package Code | Packaging (Note 7) | 7"/13" Tape and Reel | |
|---------------|--------------|--------------------|----------------------|--------------------|
| | | | Quantity | Part Number Suffix |
| AP21X2ASG-13 | S | SO-8 | 2500/Tape & Reel | -13 |
| AP21X2AMPG-13 | MP | MSOP-8-EP | 2500/Tape & Reel | -13 |
| AP21X2AFGEG-7 | FGE | DFN3030E-8 | 3000/Tape & Reel | -7 |

Notes: 7. Pad layout as shown on Diodes Inc. suggested pad layout document AP02001, which can be found on our website at <http://www.diodes.com/datasheets/ap02001.pdf>.

Marking Information

(1) SO-8

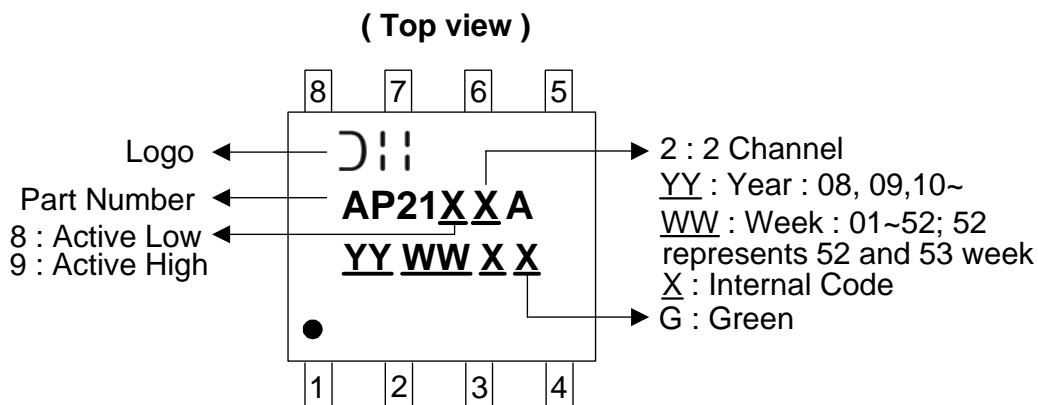

(2) MSOP-8-EP

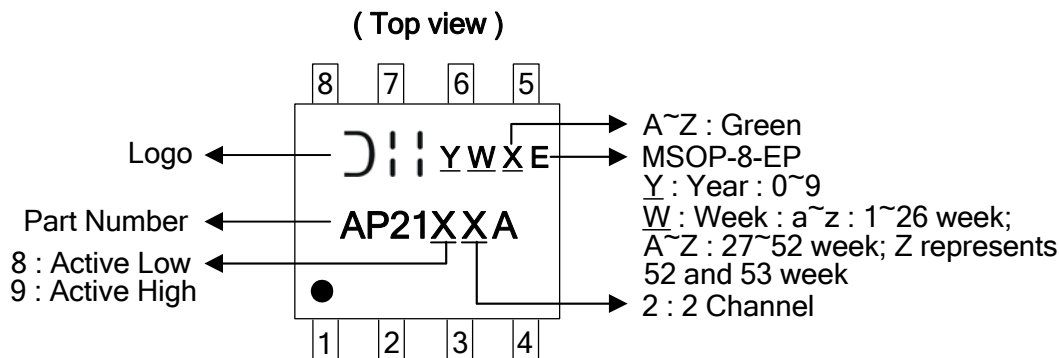

Marking Information (Continued)

(3) DFN3030E-8

(Top View)

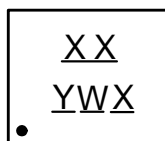

XX : Identification Code
Y : Year : 0~9
W : Week : A~Z : 1~26 week;
a~z : 27~52 week; z represents
52 and 53 week
X : A~Z : Green

| Part Number | Package | Identification Code |
|---------------|------------|---------------------|
| AP2182AFGEG-7 | DFN3030E-8 | AE |
| AP2192AFGEG-7 | DFN3030E-8 | AF |

Package Outline Dimensions (All Dimensions in mm)

(1) Package type: SO-8

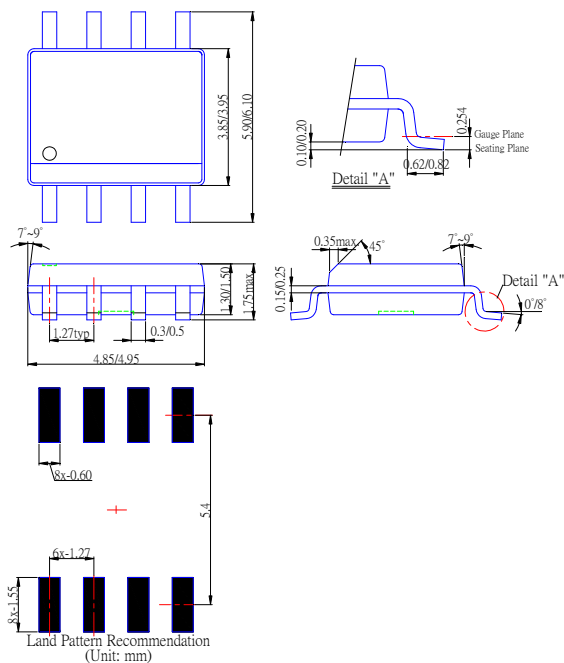

NEW PRODUCT

Package Outline Dimensions (Continued)

(2) Package type: MSOP-8-EP

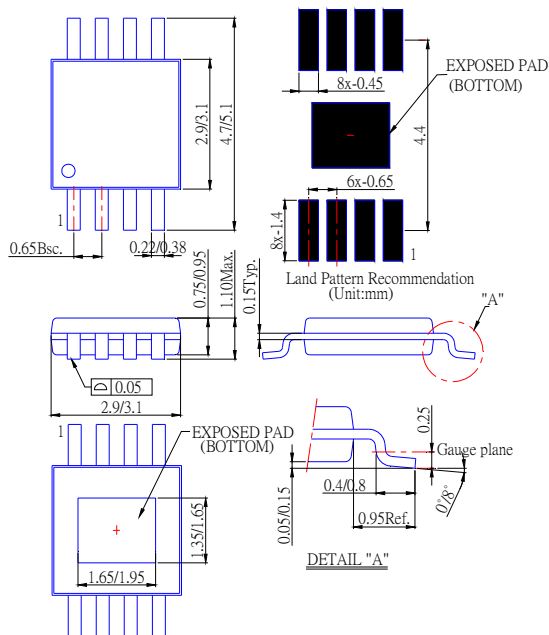

(3) Package type: DFN3030E-8

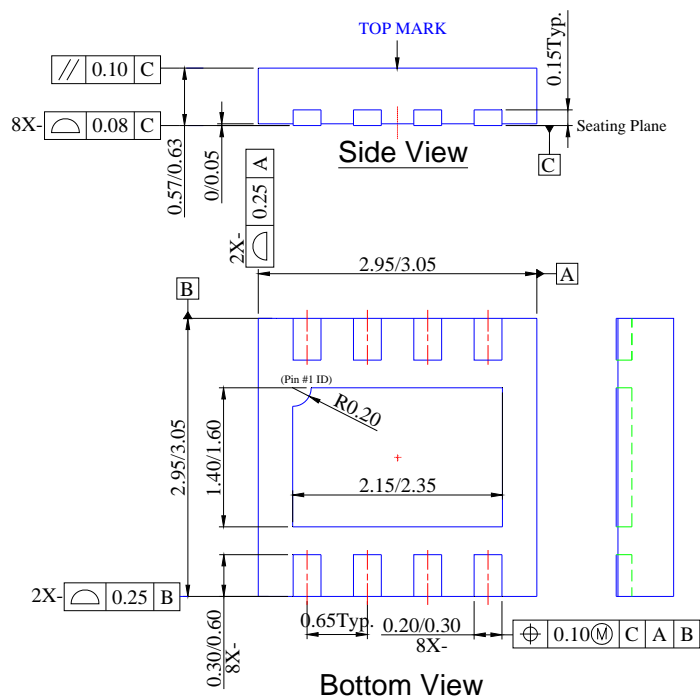

Taping Orientation (Note 8)

For DFN3030E-8

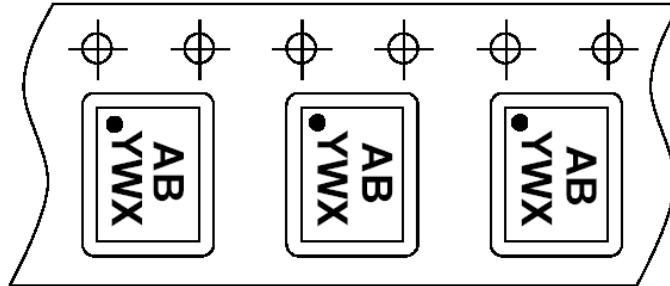

Notes: 8. The taping orientation of the other package type can be found on our website at <http://www.diodes.com/datasheets/ap02007.pdf>

IMPORTANT NOTICE

DIODES INCORPORATED MAKES NO WARRANTY OF ANY KIND, EXPRESS OR IMPLIED, WITH REGARDS TO THIS DOCUMENT, INCLUDING, BUT NOT LIMITED TO, THE IMPLIED WARRANTIES OF MERCHANTABILITY AND FITNESS FOR A PARTICULAR PURPOSE (AND THEIR EQUIVALENTS UNDER THE LAWS OF ANY JURISDICTION).

Diodes Incorporated and its subsidiaries reserve the right to make modifications, enhancements, improvements, corrections or other changes without further notice to this document and any product described herein. Diodes Incorporated does not assume any liability arising out of the application or use of this document or any product described herein; neither does Diodes Incorporated convey any license under its patent or trademark rights, nor the rights of others. Any Customer or user of this document or products described herein in such applications shall assume all risks of such use and will agree to hold Diodes Incorporated and all the companies whose products are represented on Diodes Incorporated website, harmless against all damages.

Diodes Incorporated does not warrant or accept any liability whatsoever in respect of any products purchased through unauthorized sales channel.

Should Customers purchase or use Diodes Incorporated products for any unintended or unauthorized application, Customers shall indemnify and hold Diodes Incorporated and its representatives harmless against all claims, damages, expenses, and attorney fees arising out of, directly or indirectly, any claim of personal injury or death associated with such unintended or unauthorized application.

Products described herein may be covered by one or more United States, international or foreign patents pending. Product names and markings noted herein may also be covered by one or more United States, international or foreign trademarks.

LIFE SUPPORT

Diodes Incorporated products are specifically not authorized for use as critical components in life support devices or systems without the express written approval of the Chief Executive Officer of Diodes Incorporated. As used herein:

A. Life support devices or systems are devices or systems which:

1. are intended to implant into the body, or
2. support or sustain life and whose failure to perform when properly used in accordance with instructions for use provided in the labeling can be reasonably expected to result in significant injury to the user.

B. A critical component is any component in a life support device or system whose failure to perform can be reasonably expected to cause the failure of the life support device or to affect its safety or effectiveness.

Customers represent that they have all necessary expertise in the safety and regulatory ramifications of their life support devices or systems, and acknowledge and agree that they are solely responsible for all legal, regulatory and safety-related requirements concerning their products and any use of Diodes Incorporated products in such safety-critical, life support devices or systems, notwithstanding any devices- or systems-related information or support that may be provided by Diodes Incorporated. Further, Customers must fully indemnify Diodes Incorporated and its representatives against any damages arising out of the use of Diodes Incorporated products in such safety-critical, life support devices or systems.

Copyright © 2010, Diodes Incorporated

www.diodes.com