

Description

The AH5798 is a single chip solution for driving single-coil brushless direct current (BLDC) fans and motors. The integrated full-bridge driver output stage uses soft switching to minimize audible switching noise and electromagnetic interference (EMI) providing a low noise solution.

To help protect the motor coil, the AH5798 provides Rotor Lock Protection which shuts down output drive if rotor lock is detected. The device automatically re-starts when the rotor lock is removed. Over temperature shutdown provides thermal protection for the device.

A Tachometer output is provided by open-drain Frequency Generator (FG) Pin which allows external interface to monitor motor rotation or speed. The FG output is the magnetic change frequency.

The AH5798 is available in space saving SOT89-5L and thinner TSOT25 packages.

Features

- Supports single-coil full-wave DC fan drivers
- Built-in Hall sensor and input amplifier
- Operating Voltage: 1.8V to 5.5V
- Soft switching for low noise DC fan motor applications
- Rotor Lock Protection (Lock detection, output shutdown and automatic re-start)
- Thermal protection
- Tachometer (FG) output
- No external timing capacitor - Reduces the numbers of external components required
- Low profile packages: SOT89-5L and TSOT25
- “Green” Molding Compound

Pin Assignments

(Top View)

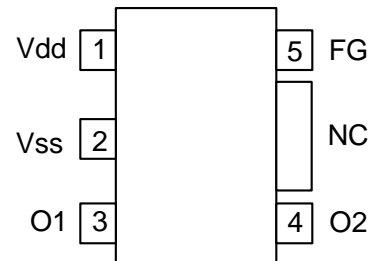

SOT89-5L

(Top View)

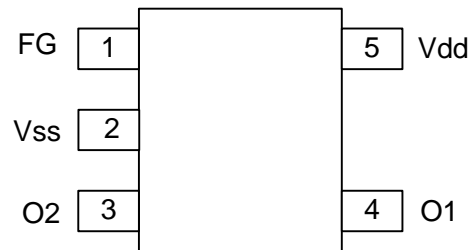

TSOT25

Applications

- 3.3V / 5V Min. BLDC Cooling Fans
- Netbook/ Notebook BLDC fans
- Low Voltage/ Low Power BLDC Motors

Typical Application Circuit

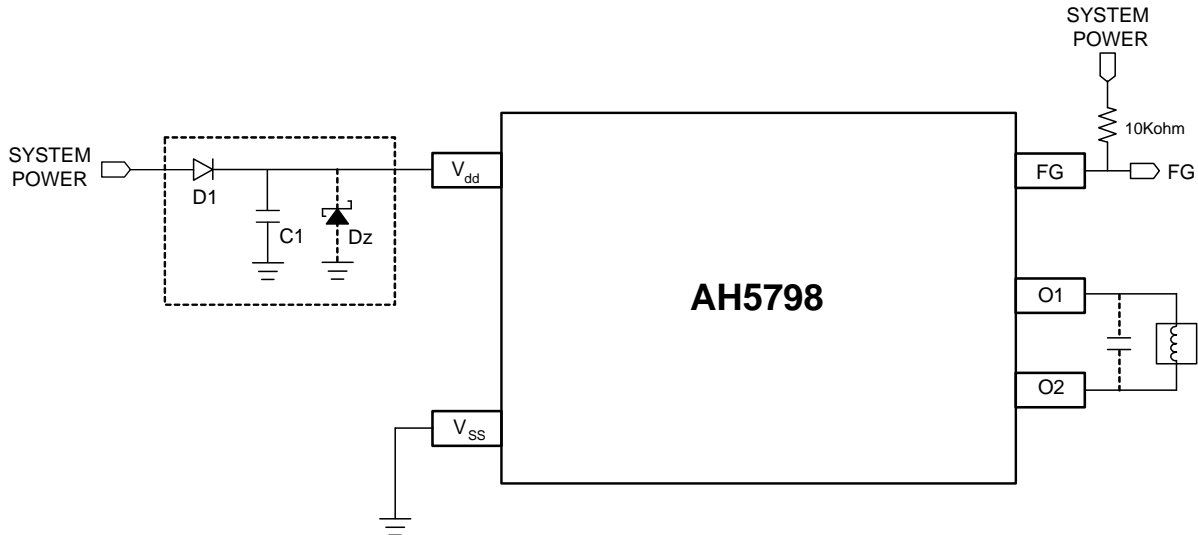

- * Reverse connection of power supply may damage the device. To prevent reverse power damage, a protection (reverse blocking) Diode D1 is needed between power supply and Vdd terminal. If a reverse power protection diode D1 is used, there is no current return path to power supply, so it is necessary to follow measures such as below.
- Connect Dz (Zener diode) between Vdd and Vss terminal, to prevent voltage exceeding the absolute maximum rating of the device.
 - Connect a capacitor C1 between Vdd and Vss terminal, to complete the current return path to power supply.

The AH5798 has an open-drain tachometer FG output that follows the magnetic change frequency. Typically, a pull-up resistor of 10kΩ is recommended from FG pin to the supply voltage.

Pin Descriptions

Pin Name	Description
Vdd	Power Supply Pin
Vss	Ground Pin
O1	Output Driving & Sinking Pin 1
O2	Output Driving & Sinking Pin 2
NC	No Connection
FG	Frequency Generator (Note 1)

Notes: 1. The FG is the same as the magnetic change frequency.

Functional Block Diagram

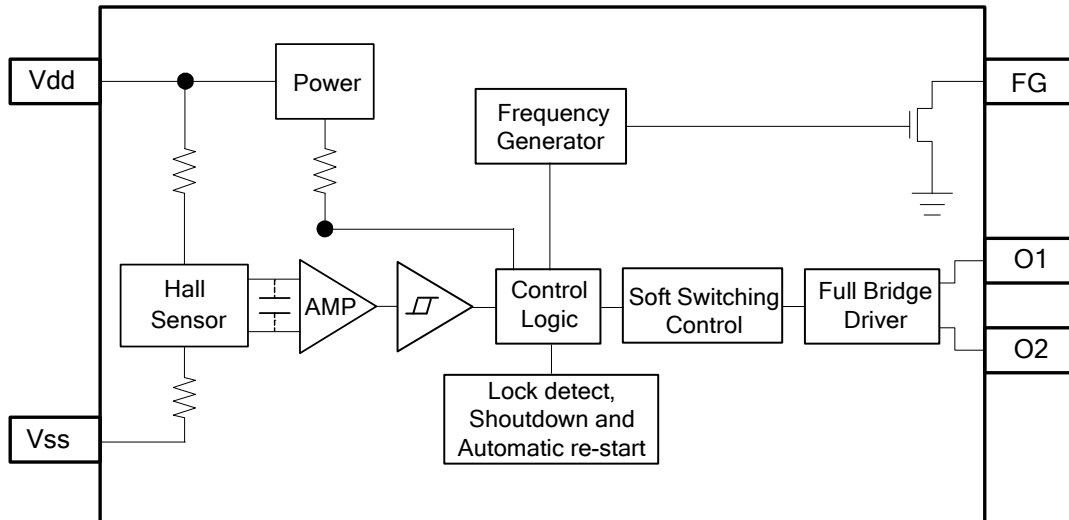

Operating

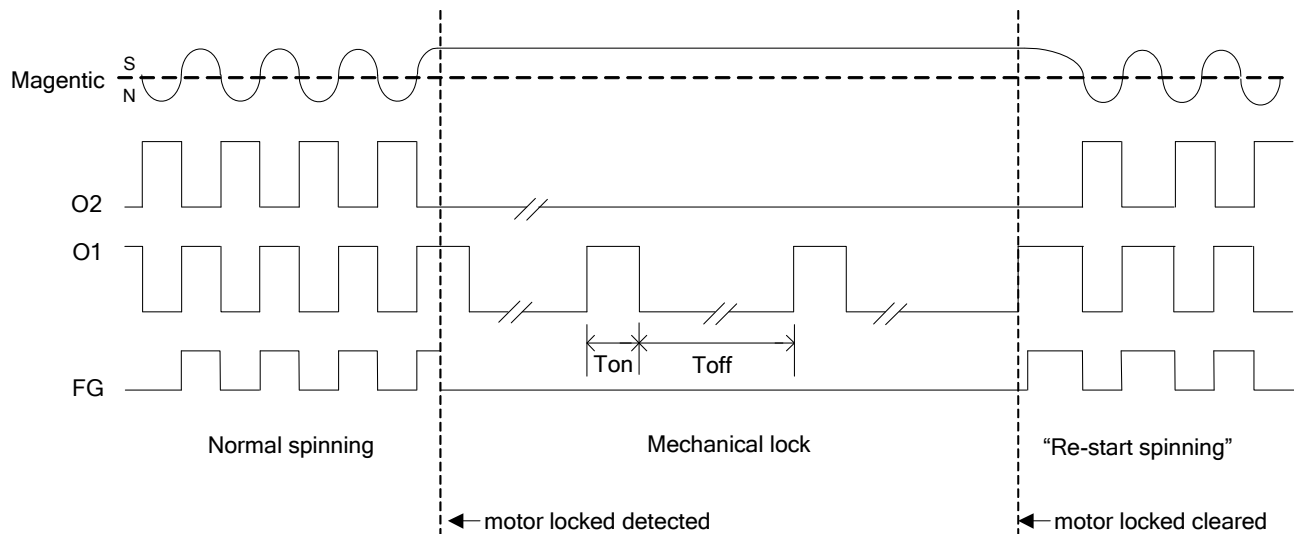

- Notes:
2. In "Normal spinning", the FG changes its state at each rising edge of O1.
 3. When the motor locks with South pole at the Hall element, O2 is kept on "L" and O1 is a clock with Ton/Toff ratio. When motor locks with North pole at the Hall element, O1 is kept on "L", O2 is a clock with Ton/Toff ratio.
 4. When "Re-start spinning" occurs, the motor speed ramps up to the "Normal Spinning" speed from zero. Speed ramp-up profile depends on motor characteristics.

Soft Switching

AH5798 employs soft switching of output drive at commutation to reduce audible noise and EMI for low noise applications.

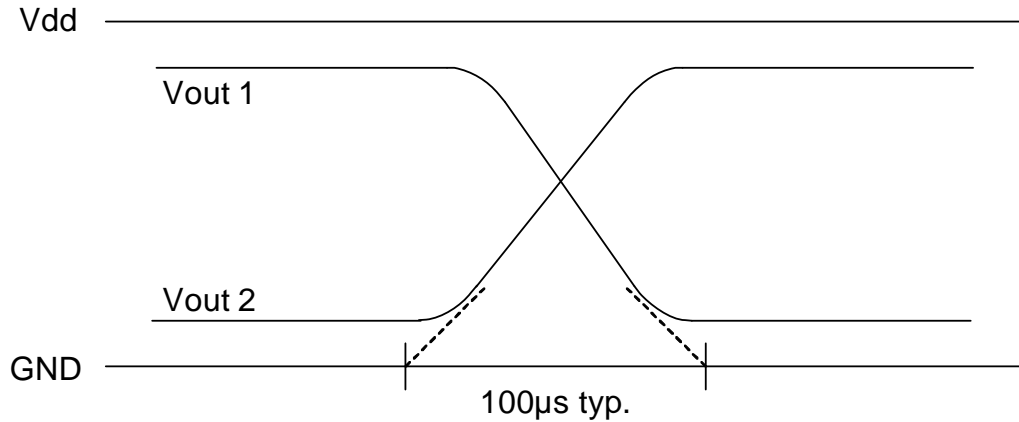

Absolute Maximum Ratings ($T_A = 25^\circ\text{C}$, unless otherwise noted)

Symbol	Parameter	Rating	Unit
Vdd	Supply voltage	6	V
$I_{O(PEAK)}$	Maximum Output Current (Peak)	800	mA
P_D	Power Dissipation	SOT89-5L	800
		TSOT25	520
T_{ST}	Storage Temperature Range	-65 ~ 150	$^\circ\text{C}$
θ_{JA}	Thermal Resistance Junction-to-Ambient (Note 5)	SOT89-5L	156
		TSOT25	240

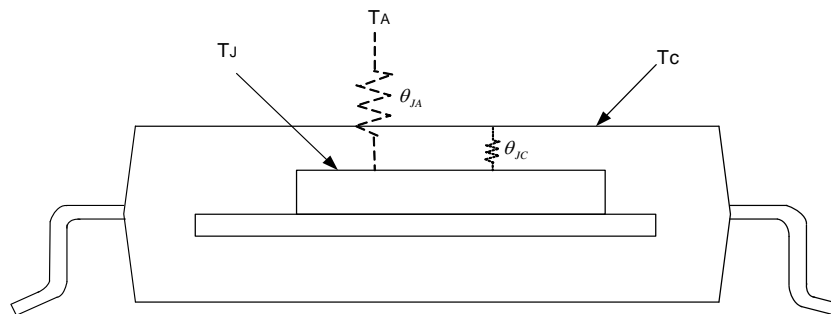

Notes: 5. θ_{JA} should be confirmed with heat sink thermal resistance. If there is no heat sink contact, θ_{JA} will almost be the same as θ_{JC} .

Recommended Operating Conditions ($T_A = 25^\circ\text{C}$)

Symbol	Parameter	Conditions	Min	Max	Unit
Vdd	Supply Voltage	Operating	1.8	5.5	$^\circ\text{C}$
T_A	Operating Ambient Temperature Range	Operating	-40	105	V

Electrical Characteristics ($T_A = 25^\circ\text{C}$, $V_{DD} = 5\text{V}$)

Symbol	Parameter	Test Conditions	Min	Typ.	Max	Unit
I_{DD}	Supply Current	No Load	-	5	-	mA
V_{OH}	Output Voltage High	$I_{OUT} = 300\text{mA}$	4.4	4.65	-	V
V_{OL}	Output Voltage Low	$I_{OUT} = 300\text{mA}$	-	0.35	0.6	V
T_{SW}	Output Switching Slope Duration	50Ω load on out1/out2	-	100	-	μs
I_{LEAK}	FG Output Leakage Current		-	-	5	μA
V_{FGOL}	FG Output Voltage Low	$I_{FG} = 5\text{mA}$	-	-	0.4	V
T_{ON}	On Time		350	500	650	ms
R_{DR}	Duty Ratio	T_{OFF} / T_{ON}	-	10	-	

Magnetic Characteristics ($T_A = 25^\circ\text{C}$, $V_{DD} = 1.8\text{V} \sim 5\text{V}$, Note 6)

(1mT = 10 G)

Symbol	Parameter	Min	Typ.	Max	Unit
B_{op}	Operate Point	10	25	50	G
B_{rp}	Release Point	-50	-25	-10	G
B_{hy}	Hysteresis	-	50	-	G

Notes: 6. The magnetic characteristics may vary with supply voltage, operating temperature and after soldering.

Operating Characteristics

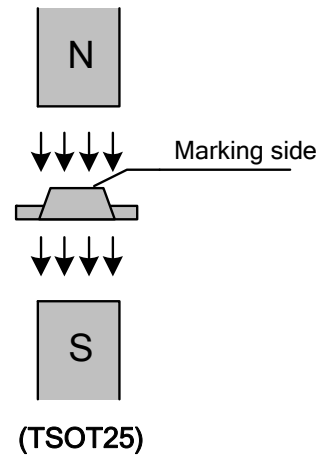
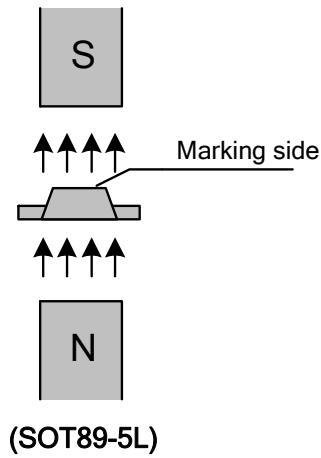
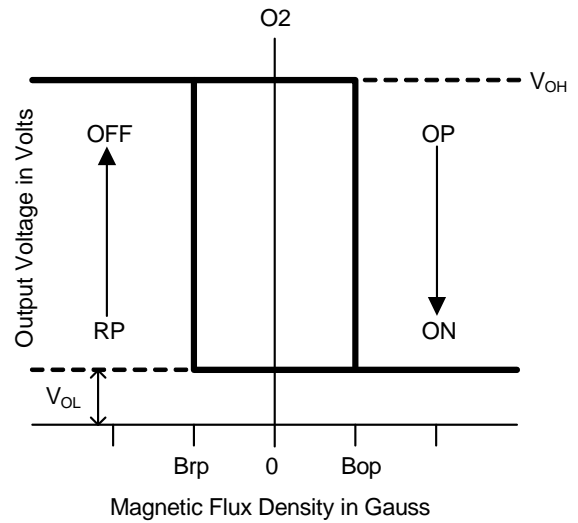
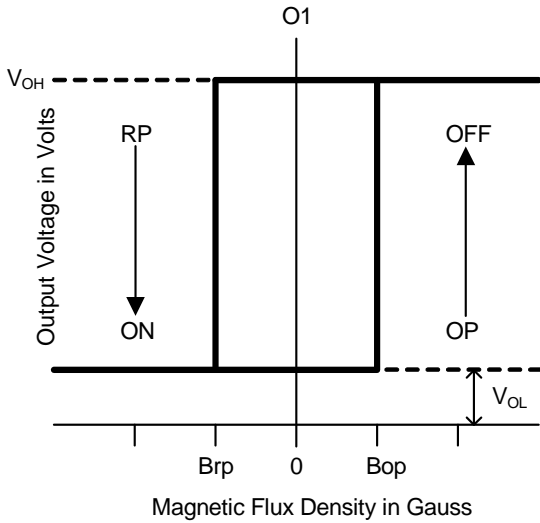

Performance Characteristics

(1) SOT89-5L

T_A (°C)	25	50	60	70	75	80	85	90	95	100
P _D (mW)	800	640	576	512	480	448	416	384	352	320
T_A (°C)	105	110	115	120	125	130	135	140	145	150
P _D (mW)	288	256	224	192	160	128	96	64	32	0

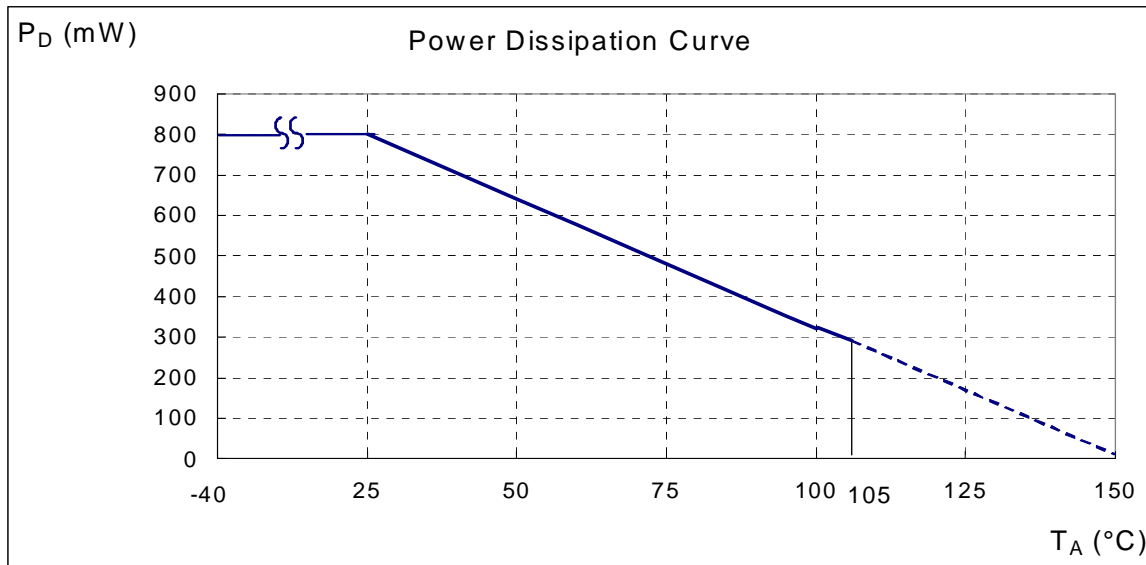

(2) TSOT25

T_A (°C)	25	50	60	70	75	80	85	90	95	100
P _D (mW)	520	417	375	333	313	292	271	250	230	208
T_A (°C)	105	110	115	120	125	130	135	140	145	150
P _D (mW)	188	167	146	125	104	83	63	42	21	0

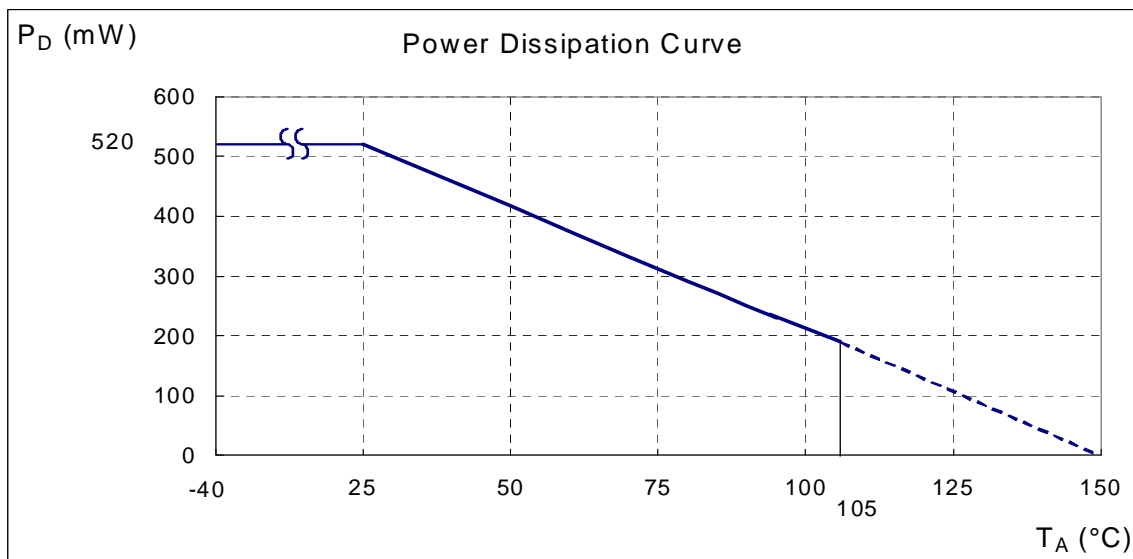

Ordering Information

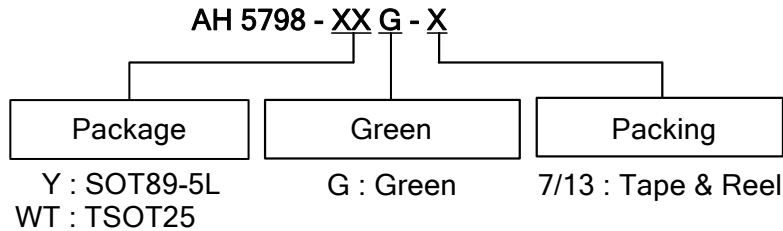

Device	Package Code	Packaging (Note 7 & 8)	7"/13" Tape and Reel	
			Quantity	Part Number Suffix
AH5798-YG-13	Y	SOT89-5L	2500/Tape & Reel	-13
AH5798-WTG-7	WT	TSOT25	3000/Tape & Reel	-7

Notes: 7. Pad layout as shown on Diodes Inc. suggested pad layout document AP02001, which can be found on our website at <http://www.diodes.com/datasheets/ap02001.pdf>
 8. EU Directive 2002/95/EC (RoHS). All applicable RoHS exemptions applied. Please visit our website at http://www.diodes.com/products/lead_free.html

Marking Information

(1) SOT89-5L

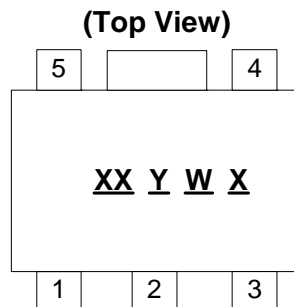

XX : Identification code
Y : Year : 0~9
W : Week : A~Z : 1~26 week;
 a~z : 27~52 week;
 z represents 52 and 53 week
X : Internal code
 A~Z : Green

Part Number	Package	Identification Code
AH5798-YG	SOT89-5L	K4

(2) TSOT25

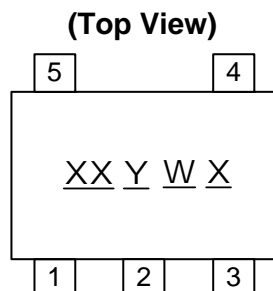

XX : Identification code
Y : Year 0~9
W : Week : A~Z : 1~26 week;
 a~z : 27~52 week;
 z represents 52 and 53 week
X : A~Z : Green

Part Number	Package	Identification Code
AH5798-WTG	TSOT25	K4

Package Outline Dimensions (All Dimensions in mm)

(1) Package type: SOT89-5L

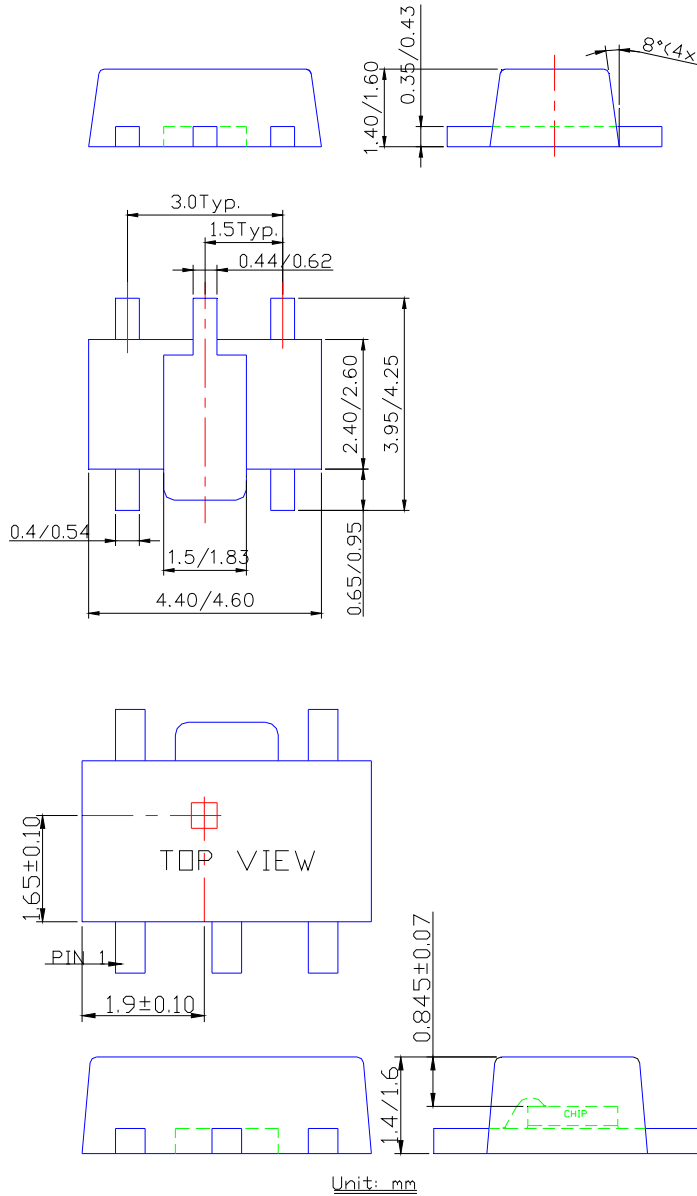

Sensor Location

Package Outline Dimensions (Continued)

(2) Package type: TSOT25

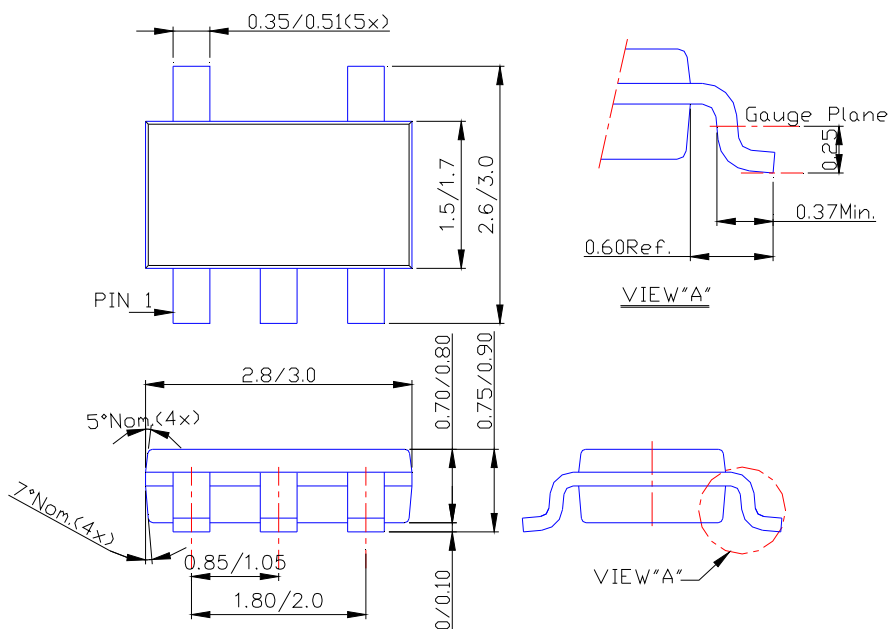

TSOT25L Package

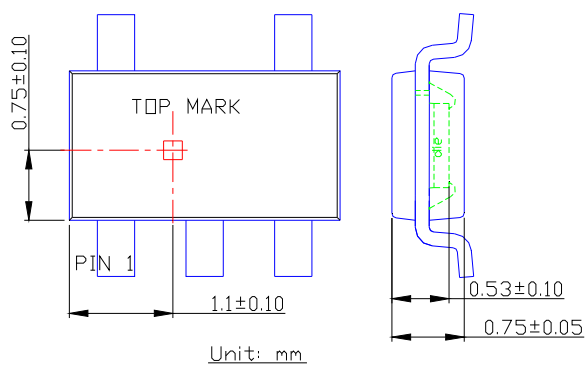

Sensor Location

**SINGLE PHASE HALL EFFECT LATCH SMART
FAN MOTOR CONTROLLER****IMPORTANT NOTICE**

DIODES INCORPORATED MAKES NO WARRANTY OF ANY KIND, EXPRESS OR IMPLIED, WITH REGARDS TO THIS DOCUMENT, INCLUDING, BUT NOT LIMITED TO, THE IMPLIED WARRANTIES OF MERCHANTABILITY AND FITNESS FOR A PARTICULAR PURPOSE (AND THEIR EQUIVALENTS UNDER THE LAWS OF ANY JURISDICTION).

Diodes Incorporated and its subsidiaries reserve the right to make modifications, enhancements, improvements, corrections or other changes without further notice to this document and any product described herein. Diodes Incorporated does not assume any liability arising out of the application or use of this document or any product described herein; neither does Diodes Incorporated convey any license under its patent or trademark rights, nor the rights of others. Any Customer or user of this document or products described herein in such applications shall assume all risks of such use and will agree to hold Diodes Incorporated and all the companies whose products are represented on Diodes Incorporated website, harmless against all damages.

Diodes Incorporated does not warrant or accept any liability whatsoever in respect of any products purchased through unauthorized sales channel.

Should Customers purchase or use Diodes Incorporated products for any unintended or unauthorized application, Customers shall indemnify and hold Diodes Incorporated and its representatives harmless against all claims, damages, expenses, and attorney fees arising out of, directly or indirectly, any claim of personal injury or death associated with such unintended or unauthorized application.

Products described herein may be covered by one or more United States, international or foreign patents pending. Product names and markings noted herein may also be covered by one or more United States, international or foreign trademarks.

LIFE SUPPORT

Diodes Incorporated products are specifically not authorized for use as critical components in life support devices or systems without the express written approval of the Chief Executive Officer of Diodes Incorporated. As used herein:

A. Life support devices or systems are devices or systems which:

1. are intended to implant into the body, or
2. support or sustain life and whose failure to perform when properly used in accordance with instructions for use provided in the labeling can be reasonably expected to result in significant injury to the user.

B. A critical component is any component in a life support device or system whose failure to perform can be reasonably expected to cause the failure of the life support device or to affect its safety or effectiveness.

Customers represent that they have all necessary expertise in the safety and regulatory ramifications of their life support devices or systems, and acknowledge and agree that they are solely responsible for all legal, regulatory and safety-related requirements concerning their products and any use of Diodes Incorporated products in such safety-critical, life support devices or systems, notwithstanding any devices- or systems-related information or support that may be provided by Diodes Incorporated. Further, Customers must fully indemnify Diodes Incorporated and its representatives against any damages arising out of the use of Diodes Incorporated products in such safety-critical, life support devices or systems.

Copyright © 2010, Diodes Incorporated

www.diodes.com