



VN5772AK-E

Quad smart power solid-state relay for complete H-bridge configurations

Features

Type	$R_{DS(on)}$	I_{OUT}	V_{CC}
VN5772AK-E	100 m Ω ⁽¹⁾	18 A ⁽²⁾	36 V

1. Total resistance of one side in bridge configuration.
2. Typical current limitation value.

■ General features

- Inrush current management by active power limitation on the high-side switches
- Very low standby current
- Very low electromagnetic susceptibility
- In compliance with the 2002/95/EC European directive

■ Protections

- High-side drivers under voltage shutdown
- Overvoltage clamp
- Output current limitation
- High and low-side over temperature shutdown
- Short-circuit protection
- ESD protection

■ Diagnostic functions

- Proportional load current sense
- Thermal shutdown indication on both the high and low-side switches

Applications

- DC motor driving in full or half-bridge configuration
- All types of resistive, inductive and capacitive loads

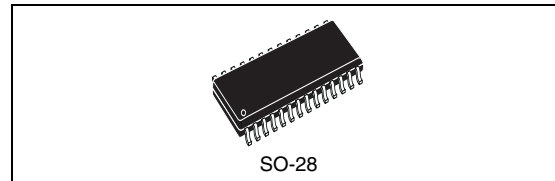

Description

The VN5772AK-E is a device formed by three monolithic chips housed in a standard SO-28 package: a double high-side and two low-side switches. The double high-side is made using STMicroelectronics VIPower M0-5 technology, while the low-side switches are fully protected VIPower M0-5 OMNIFET III. This device is suitable to drive a DC motor in a bridge configuration as well as to be used as a quad switch for any low-voltage application. The dual high-side switches integrate built-in non latching thermal shutdown with thermal hysteresis. An output current limiter protects the device in overload condition. In the case of long overload duration, the device limits the dissipated power to a safe level up to thermal shutdown intervention. An analog current sense pin delivers a current proportional to the load current (according to a known ratio) and indicates over temperature shutdown of the relevant high-side switch through a voltage flag. The low side switches have built-in non latching thermal shutdown with thermal hysteresis, linear current limitation and overvoltage clamping. Fault feedback for over temperature shutdown of the low side switch is indicated by the relevant input pin current consumption going up to the fault sink current flag.

Table 1. Device summary

Package	Order codes	
	Tube	Tape and reel
SO-28	VN5772AK-E	VN5772AKTR-E

Contents

1	Block diagram and pin description	5
2	Electrical specification	7
2.1	Absolute maximum ratings	7
2.2	Thermal data	8
2.3	Electrical characteristics	9
2.3.1	Electrical characteristics for dual high-side switches	9
2.4	Electrical characteristics curves for dual high-side switches	14
2.5	Electrical characteristics for low-side switch	16
2.6	Electrical characteristics curves for low-side switch	19
3	Application information	21
3.1	Maximum demagnetization energy ($V_{CC} = 13.5 \text{ V}$)	24
4	Package and PC board thermal data	25
4.1	SO-28 thermal data	25
5	Package and packing information	30
5.1	ECOPACK [®] package	30
5.2	Package mechanical data	30
5.3	Packing information	32
6	Revision history	33

List of tables

Table 1.	Device summary	1
Table 2.	Pin description	6
Table 3.	Dual high-side switch	7
Table 4.	Low side switch.	8
Table 5.	Thermal data.	8
Table 6.	Power section	9
Table 7.	Switching ($V_{CC} = 13\text{ V}$)	9
Table 8.	Logic inputs.	10
Table 9.	Protection and diagnostics	10
Table 10.	Current sense ($8\text{ V} < V_{CC} < 16\text{ V}$)	11
Table 11.	Truth table high-side driver	13
Table 12.	PowerMOS section - off	16
Table 13.	PowerMOS section - On	16
Table 14.	Switching ($T_j = 25^\circ\text{ C}$, unless otherwise specified)	16
Table 15.	Source drain diode	16
Table 16.	Input section	17
Table 17.	STATUS pin	17
Table 18.	Protection and diagnostics ($-40^\circ\text{ C} < T_j < 150^\circ\text{ C}$, unless otherwise specified)	17
Table 19.	Truth table low-side driver	18
Table 20.	Thermal calculations in clockwise and anti-clockwise operation in steady-state mode	26
Table 21.	Thermal resistances definitions	26
Table 22.	Single pulse thermal impedance definitions	27
Table 23.	Thermal calculations in transient mode	27
Table 24.	Thermal parameters	29
Table 25.	SO-28 mechanical data	31
Table 26.	Document revision history	33

List of figures

Figure 1.	Block diagram	5
Figure 2.	Configuration diagram (top view)	6
Figure 3.	Current sense delay characteristics	12
Figure 4.	Switching time waveforms	12
Figure 5.	Output voltage drop limitation	12
Figure 6.	Off-state output current	14
Figure 7.	High-level input current	14
Figure 8.	Input voltage clamp	14
Figure 9.	Low level input voltage	14
Figure 10.	High-level input voltage	14
Figure 11.	Input voltage hysteresis	14
Figure 12.	On-state resistance vs Tcase	15
Figure 13.	On-state resistance vs VCC	15
Figure 14.	Undervoltage shutdown	15
Figure 15.	Turn-on voltage slope	15
Figure 16.	I_{LIMH} vs Tcase	15
Figure 17.	Turn-off voltage slope	15
Figure 18.	Source diode forward characteristics	19
Figure 19.	Static drain source on-resistance vs drain current (3 pin)	19
Figure 20.	Static drain source on-resistance vs input voltage (3 pin)	19
Figure 21.	Static drain source on-resistance vs drain current	19
Figure 22.	Transfer characteristics	19
Figure 23.	Output characteristics	19
Figure 24.	Normalized on-resistance vs temperature	20
Figure 25.	Normalized input threshold vs temperature	20
Figure 26.	Typical application schematic	21
Figure 27.	Recommended motor operation	22
Figure 28.	Waveforms (high-side switches)	23
Figure 29.	Maximum turn-off current vs load inductance ⁽¹⁾	24
Figure 30.	SO-28 PC board ⁽¹⁾	25
Figure 31.	Chipset configuration	25
Figure 32.	Auto and mutual Rthj-amb vs PCB copper area in open box free air condition ⁽¹⁾	26
Figure 33.	SO-28 HSD thermal impedance junction-ambient single pulse	27
Figure 34.	SO-28 LSD thermal impedance junction-ambient single pulse	28
Figure 35.	Thermal fitting model of an H-bridge in SO-28	29
Figure 36.	SO-28 package dimensions	30
Figure 37.	SO-28 tube shipment (no suffix)	32
Figure 38.	Tape and reel shipment (suffix "TR")	32

1 Block diagram and pin description

Figure 1. Block diagram

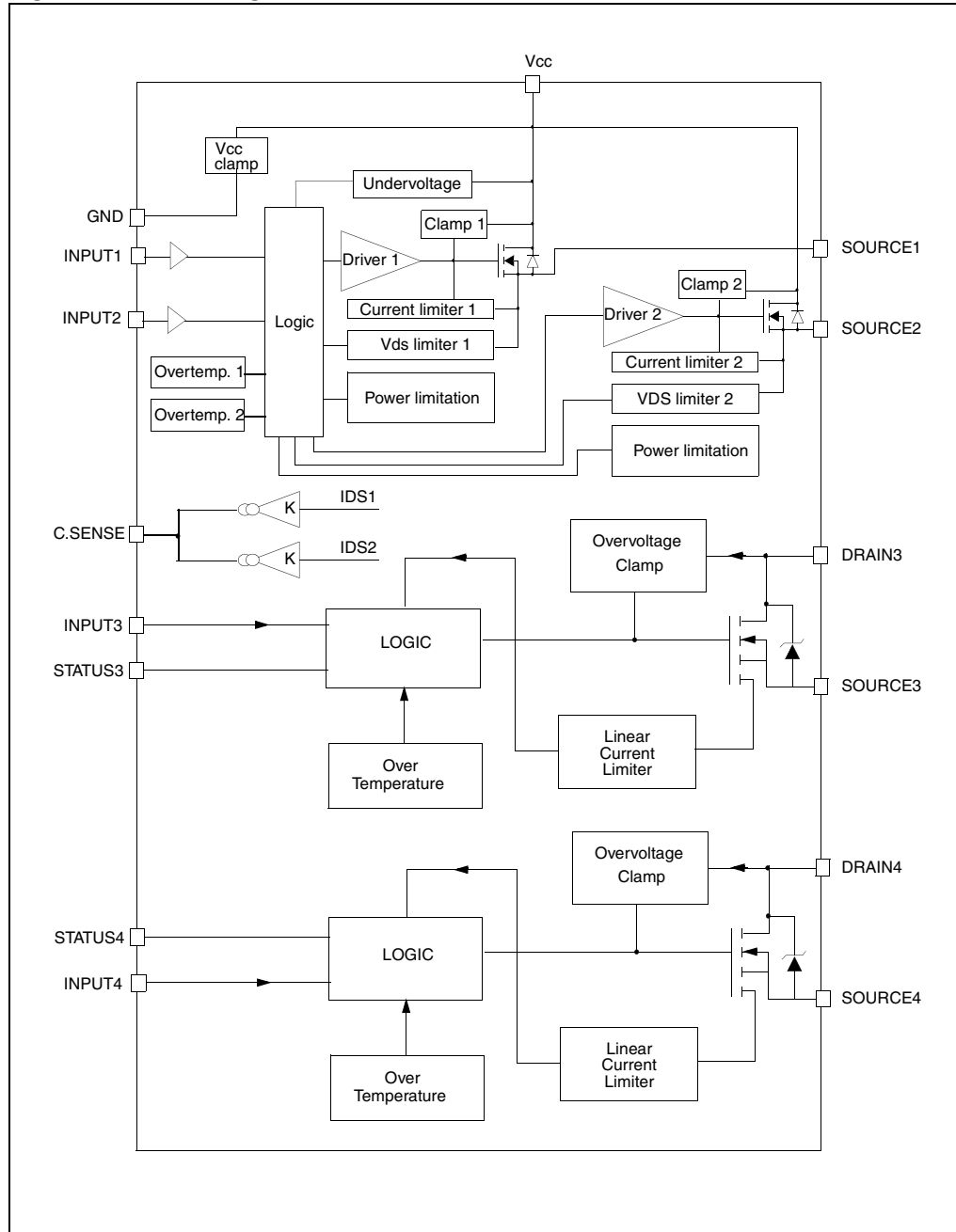
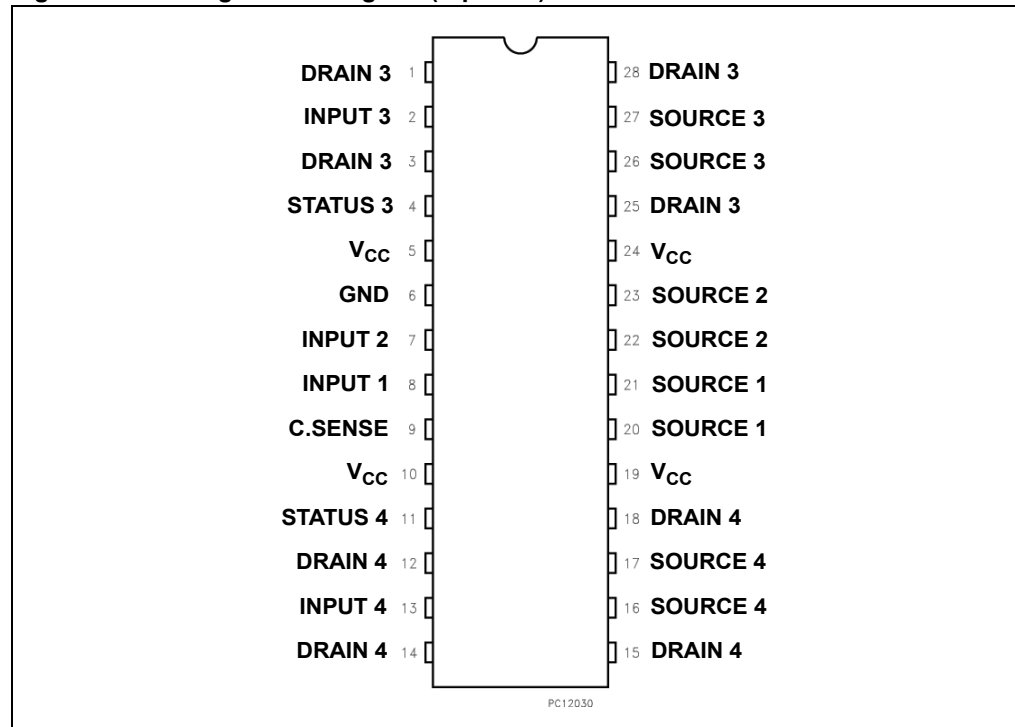

Table 2. Pin description

N° pin	Name	Function
1, 3, 25, 28	DRAIN 3	Drain of switch 3 (low-side switches)
2	INPUT 3	Input of switch 3 (low-side switch)
4	STATUS 3	Status of switch 3 (low-side switch)
11	STATUS 4	Status of switch 4 (low-side switch)
5, 10, 19, 24	V _{CC}	Drain of switches 1 and 2 (high-side switches) and power supply voltage
6	GND	Ground of switches 1 and 2 (high-side switches)
8	INPUT 1	Input of switch 1 (high-side switch)
7	INPUT 2	Input of switch 2 (high-side switch)
9	C.SENSE	Analog current sense pin, delivers a current proportional to the load current
12, 14, 15, 18	DRAIN 4	Drain of switch 4 (low-side switches)
13	INPUT 4	Input of switch 4 (low-side switch)
16, 17	SOURCE 4	Source of switch 4 (low-side switches)
22, 23	SOURCE 2	Source of switch 2 (high-side switches)
20, 21	SOURCE 1	Source of switch 1 (high-side switches)
26, 27	SOURCE 3	Source of switch 3 (low-side switches)

Figure 2. Configuration diagram (top view)

2 Electrical specification

2.1 Absolute maximum ratings

Stressing the device above the rating listed in the “absolute maximum ratings” table may cause permanent damage to the device. These are stress ratings only and operation of the device at these or any other conditions above those indicated in the operating sections of this specification is not implied. Exposure to the conditions in the tables below for extended periods may affect device reliability. Refer also to the STMicroelectronics SURE program and other relevant quality document.

Table 3. Dual high-side switch

Symbol	Parameter	Value	Unit
V_{CC}	DC supply voltage	41	V
$-V_{CC}$	Reverse DC supply voltage	0.3	V
$-I_{GND}$	DC reverse ground pin current	200	mA
I_{OUT}	DC output current	Internally limited	A
$-I_{OUT}$	Reverse DC output current	-12	A
I_{IN}	DC input current	-1 to 10	mA
$-I_{CSENSE}$	DC reverse C.SENSE pin current	200	mA
V_{CSENSE}	Current sense maximum voltage	$V_{CC} - 41$ $+V_{CC}$	V V
E_{MAX}	Maximum switching energy (single pulse) ($L = 3$ mH; $R_L = 0$ Ω ; $V_{bat} = 13.5$ V; $T_{jstart} = 150$ °C; $I_{OUT} = I_{limL}(Typ.)$)	104	mJ
V_{ESD}	Electrostatic discharge (human body model: $R = 1.5$ K Ω ; $C = 100$ pF) – Input – Current sense – SOURCE _n /DRAIN _n – V_{CC}	4000 2000 5000 5000	V V V V
V_{ESD}	Charge device model (CDM-AEC-Q100-011)	750	V
T_j	Junction operating temperature	-40 to 150	°C
T_{stg}	Storage temperature	-55 to 150	°C

Table 4. Low side switch

Symbol	Parameter	Value	Unit
V_{DSn}	Drain-source voltage ($V_{INn} = 0$ V)	Internally clamped	V
I_{INn}	Input current	-1 to 10	mA
I_{Dn}	Drain current	Internally limited	A
$-I_{Dn}$	Reverse DC output current	-4	A
I_{STAT}	DC status current	-1 to 10	mA
V_{ESD1}	Electrostatic discharge ($R = 1.5$ K Ω , $C = 100$ pF): – Drain – Supply, status, input	5000 4000	V
V_{ESD2}	Electrostatic discharge on output pins only ($R = 330$ Ω , $C = 150$ pF)	2000	V
T_j	Operating junction-temperature	-40 to 150	$^{\circ}\text{C}$
T_{stg}	Storage temperature	-55 to 150	$^{\circ}\text{C}$

2.2 Thermal data

Table 5. Thermal data

Symbol	Parameter	Max. value	Unit
$R_{thj-leadHS}$	Thermal resistance junction-case (high-side switch)	22	$^{\circ}\text{C}/\text{W}$
$R_{thj-leadLS}$	Thermal resistance junction-case (low-side switch)	21	$^{\circ}\text{C}/\text{W}$
$R_{thj-amb}$	Thermal resistance junction-ambient (high-side switch)	47	$^{\circ}\text{C}/\text{W}$
	Thermal resistance junction-ambient (low-side switch)	57	$^{\circ}\text{C}/\text{W}$

2.3 Electrical characteristics

2.3.1 Electrical characteristics for dual high-side switches

Values specified in this section are for $8\text{ V} < V_{CC} < 36\text{ V}$; $-40\text{ }^{\circ}\text{C} < T_j < 150\text{ }^{\circ}\text{C}$, unless otherwise specified (for each channel).

Table 6. Power section

Symbol	Parameter	Test conditions	Min.	Typ.	Max.	Unit
V_{CC}	Operating supply voltage		4.5	13	36	V
V_{USD}	Undervoltage shutdown			3.5	4.5	V
$V_{USDhyst}$	Undervoltage shutdown hysteresis			0.5		V
R_{ON}	On-state resistance	$I_{OUT} = 3\text{ A}$; $T_j = 25\text{ }^{\circ}\text{C}$			50	m Ω
		$I_{OUT} = 3\text{ A}$; $T_j = 150\text{ }^{\circ}\text{C}$			100	
		$I_{OUT} = 3\text{ A}$; $V_{CC} = 5\text{ V}$; $T_j = 25\text{ }^{\circ}\text{C}$			65	
V_{clamp}	Voltage clamp	$I_S = 20\text{ mA}$	41	46	52	V
I_S	Supply current	Off-state: $V_{CC} = 13\text{ V}$; $T_j = 25\text{ }^{\circ}\text{C}$, $V_{IN} = V_{OUT} = V_{SENSE} = 0\text{ V}$		2 ⁽¹⁾	5 ⁽¹⁾	μA
		On-state: $V_{CC} = 13\text{ V}$; $V_{IN} = 5\text{ V}$, $I_{OUT} = 0\text{ A}$		3	6	mA
$I_{L(off)}$	Off-state output current ⁽²⁾	$V_{IN} = V_{OUT} = 0\text{ V}$; $V_{CC} = 13\text{ V}$, $T_j = 25\text{ }^{\circ}\text{C}$	0	0.01	3	μA
		$V_{IN} = V_{OUT} = 0\text{ V}$; $V_{CC} = 13\text{ V}$, $T_j = 125\text{ }^{\circ}\text{C}$	0		5	
V_F	Output - V_{CC} diode voltage ⁽²⁾	$I_{OUT} = 3\text{ A}$, $T_j = 150\text{ }^{\circ}\text{C}$			0.7	V

1. PowerMOS leakage included.

2. For each channel.

Table 7. Switching ($V_{CC} = 13\text{ V}$)

Symbol	Parameter	Test conditions	Min.	Typ.	Max.	Unit
$t_{d(on)}$	Turn-on delay time	$R_L = 6.5\text{ }\Omega$ (see Figure 4)	-	25	-	μs
$t_{d(off)}$	Turn-off delay time	$R_L = 6.5\text{ }\Omega$ (see Figure 4)	-	20	-	μs
$(dV_{OUT}/dt)_{on}$	Turn-on voltage slope	$R_L = 6.5\text{ }\Omega$	-	See Figure 15	-	V/ μs
$(dV_{OUT}/dt)_{off}$	Turn-off voltage slope	$R_L = 6.5\text{ }\Omega$	-	See Figure 17	-	V/ μs

Table 7. Switching ($V_{CC} = 13\text{ V}$) (continued)

Symbol	Parameter	Test conditions	Min.	Typ.	Max.	Unit
W_{ON}	Switching energy losses during t_{won}	$R_L = 6.5\ \Omega$ (see Figure 4)	-	0.24	-	mJ
W_{OFF}	Switching energy losses during t_{woff}	$R_L = 6.5\ \Omega$ (see Figure 4)	-	0.2	-	mJ

Table 8. Logic inputs

Symbol	Parameter	Test conditions	Min.	Typ.	Max.	Unit
V_{IL}	Low-level input voltage				0.9	V
I_{IL}	Low-level input current	$V_{IN} = 0.9\text{ V}$	1			μA
V_{IH}	High-level input voltage		2.1			V
I_{IH}	High-level input current	$V_{IN} = 2.1\text{ V}$			10	μA
$V_{I(hyst)}$	Input voltage hysteresis		0.25			V
V_{ICL}	Input voltage clamp	$I_{IN} = 1\text{ mA}$	5.5		7	V
		$I_{IN} = -1\text{ mA}$		-0.7		

Table 9. Protection and diagnostics⁽¹⁾

Symbol	Parameter	Test conditions	Min.	Typ.	Max.	Unit
I_{limH}	DC short-circuit current	$V_{CC} = 13\text{ V}$	12	18	24	A
		$5\text{ V} < V_{CC} < 36\text{ V}$			24	A
I_{limL}	Short-circuit current during thermal cycling	$V_{CC} = 13\text{ V}; T_R < T_J < T_{TSD}$		7		A
T_{TSD}	Shutdown temperature		150	175	200	$^{\circ}\text{C}$
T_R	Reset temperature		$T_{RS} + 1$	$T_{RS} + 5$		$^{\circ}\text{C}$
T_{RS}	Thermal reset of STATUS		135			$^{\circ}\text{C}$
T_{HYST}	Thermal hysteresis ($T_{TSD} - T_R$)			7		$^{\circ}\text{C}$
V_{DEMAG}	Turn-off output voltage clamp	$I_{OUT} = 2\text{ A}; V_{IN} = 0; L = 6\text{ mH}$	$V_{CC} - 41$	$V_{CC} - 46$	$V_{CC} - 52$	V
V_{ON}	Output voltage drop limitation	$I_{OUT} = 0.1\text{ A}, T_J = -40\text{ }^{\circ}\text{C}$ to $150\text{ }^{\circ}\text{C}$ (see Figure 5)		25		mV

1. To ensure long-term reliability under heavy overload or short-circuit conditions, protection and related diagnostic signals must be used together with a proper software strategy. If the device is subjected to abnormal conditions, this software must limit the duration and number of activation cycles.

Table 10. Current sense ($8\text{ V} < V_{CC} < 16\text{ V}$)

Symbol	Parameter	Test conditions	Min.	Typ.	Max.	Unit
K_0	I_{OUT} / I_{SENSE}	$I_{OUT} = 0.35\text{ A}$; $V_{SENSE} = 0.5\text{ V}$; $T_j = -40\text{ }^\circ\text{C}$ to $50\text{ }^\circ\text{C}$	1430	2140	2890	
K_1	I_{OUT} / I_{SENSE}	$I_{OUT} = 1\text{ A}$; $V_{SENSE} = 0.5\text{ V}$; $T_j = -40\text{ }^\circ\text{C}$ to $150\text{ }^\circ\text{C}$ $T_j = 25\text{ }^\circ\text{C}$ to $150\text{ }^\circ\text{C}$	1470 1570	2020 2020	2610 2470	
K_2	I_{OUT} / I_{SENSE}	$I_{OUT} = 2\text{ A}$; $V_{SENSE} = 4\text{ V}$; $T_j = -40\text{ }^\circ\text{C}$ to $150\text{ }^\circ\text{C}$ $T_j = 25\text{ }^\circ\text{C}$ to $150\text{ }^\circ\text{C}$	1740 1790	2020 2020	2320 2250	
K_3	I_{OUT} / I_{SENSE}	$I_{OUT} = 6\text{ A}$; $V_{SENSE} = 4\text{ V}$; $T_j = -40\text{ }^\circ\text{C}$ to $150\text{ }^\circ\text{C}$ $T_j = 25\text{ }^\circ\text{C}$ to $150\text{ }^\circ\text{C}$	1890 1890	2010 2010	2140 2140	
V_{SENSE}	Max analog sense output voltage	$I_{OUT} = 4\text{ A}$;	5			V
I_{SENSE0}	Analog sense leakage current	$I_{OUT} = 0\text{ A}$, $V_{SENSE} = 0\text{ V}$, $V_{IN} = 0\text{ V}$, $T_j = -40\text{ }^\circ\text{C}$ to $150\text{ }^\circ\text{C}$	0		1	μA
		$I_{OUT} = 0\text{ A}$, $V_{SENSE} = 0\text{ V}$, $V_{IN} = 5\text{ V}$, $T_j = -40\text{ }^\circ\text{C}$ to $150\text{ }^\circ\text{C}$	0		2	
V_{SENSEH}	Analog sense output voltage in over temperature condition	$V_{CC} = 13\text{ V}$, $R_{SENSE} = 10\text{ K}\Omega$		9		V
I_{SENSEH}	Analog sense output current in over temperature condition	$V_{CC} = 13\text{ V}$, $V_{SENSE} = 5\text{ V}$		8		mA
$t_{DSENSE2H}$	Delay response time from rising edge of INPUT pin	$V_{SENSE} < 4\text{ V}$, $0.5\text{ A} < I_{OUT} < 4\text{ A}$, $I_{SENSE} = 90\%$ of $I_{SENSE\text{ max}}$ (see Figure 3)		80	250	μs
$t_{DSENSE2L}$	Delay response time from falling edge of INPUT pin	$V_{SENSE} < 4\text{ V}$, $0.5\text{ A} < I_{OUT} < 4\text{ A}$, $I_{SENSE} = 10\%$ of $I_{SENSE\text{ max}}$ (see Figure 3)		100	250	μs

Figure 3. Current sense delay characteristics

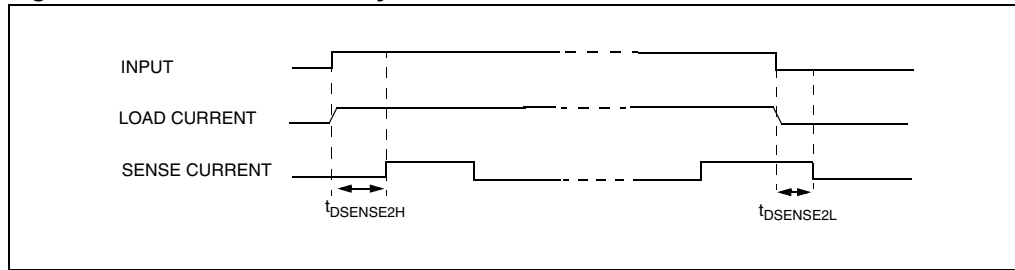

Figure 4. Switching time waveforms

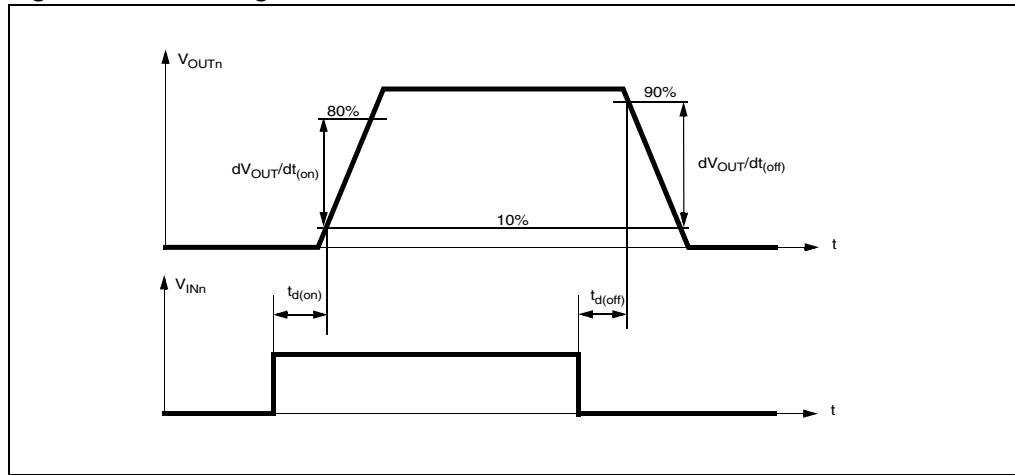

Figure 5. Output voltage drop limitation

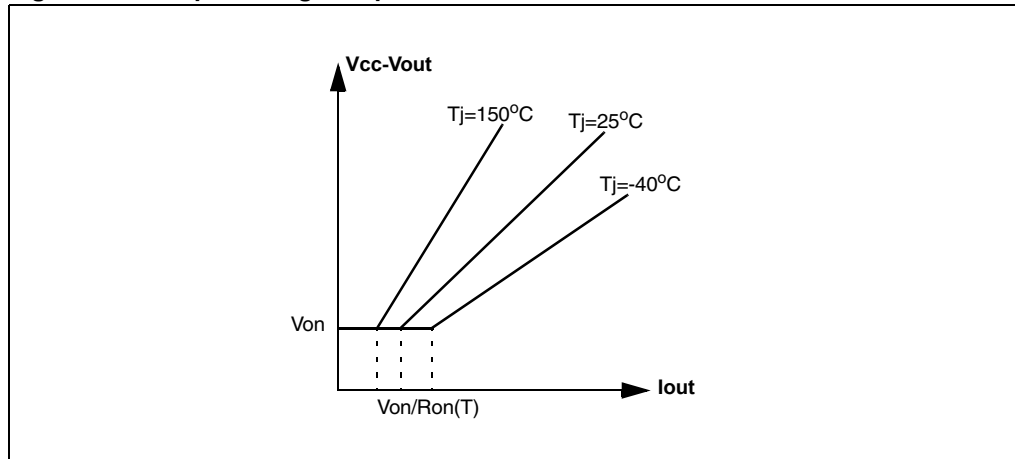

Table 11. Truth table high-side driver

Conditions	Input	Output	Sense
Normal operation	L	L	0
	H	H	Nominal
Over temperature	L	L	0
	H	L	V_{SENSEH}
Undervoltage	L	L	0
	H	L	0
Short-circuit to GND ($R_{SC} \leq 10 \text{ m}\Omega$)	L	L	0
	H	L	0 if $T_j < T_{TSD}$
	H	L	V_{SENSEH} if $T_j > T_{TSD}$
Short-circuit to V_{CC}	L	H	0
	H	H	< Nominal
Negative output voltage clamp	L	L	0

2.4 Electrical characteristics curves for dual high-side switches

Figure 6. Off-state output current

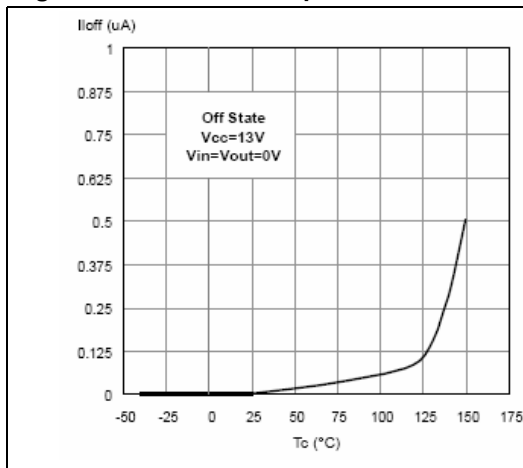

Figure 7. High-level input current

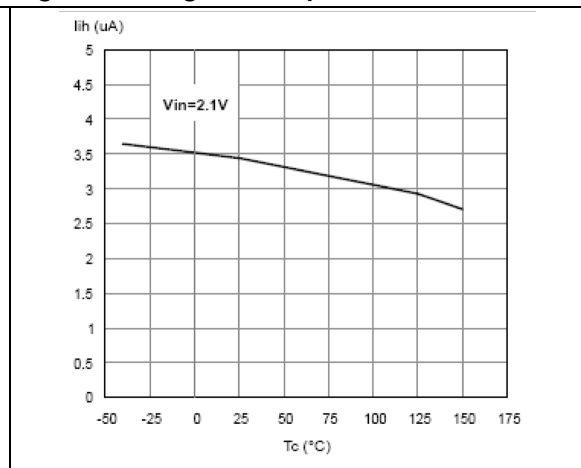

Figure 8. Input voltage clamp

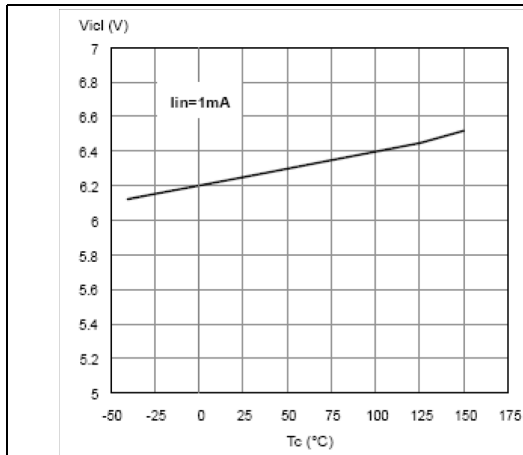

Figure 9. Low level input voltage

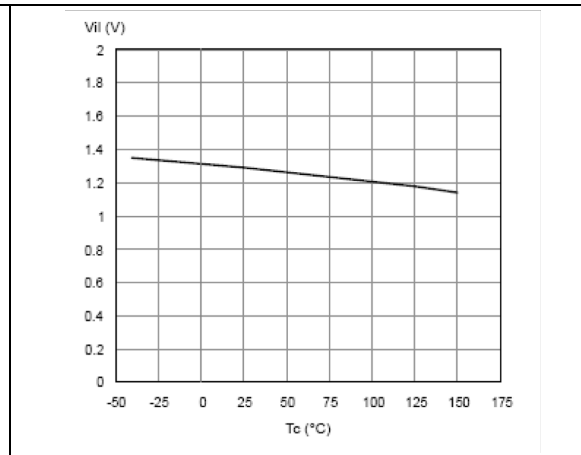

Figure 10. High-level input voltage

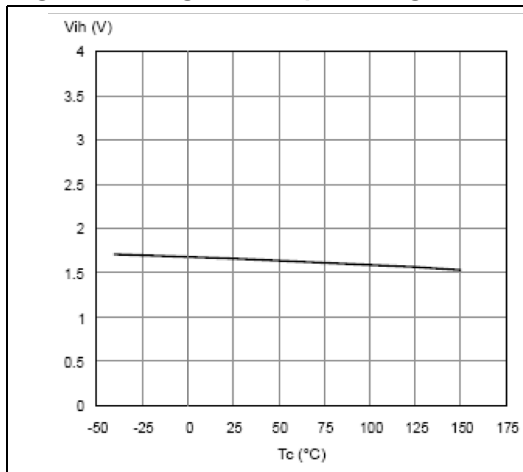

Figure 11. Input voltage hysteresis

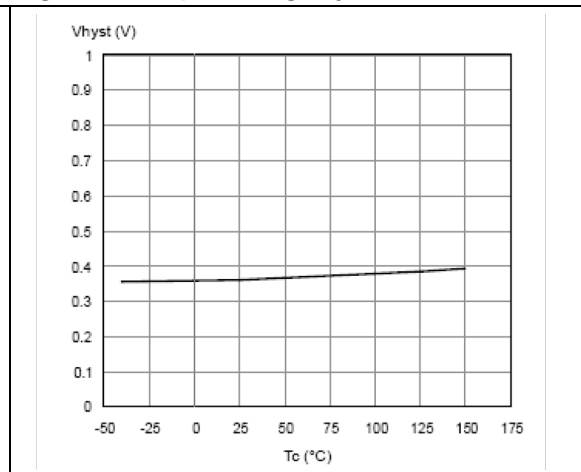

Figure 12. On-state resistance vs T_{case}

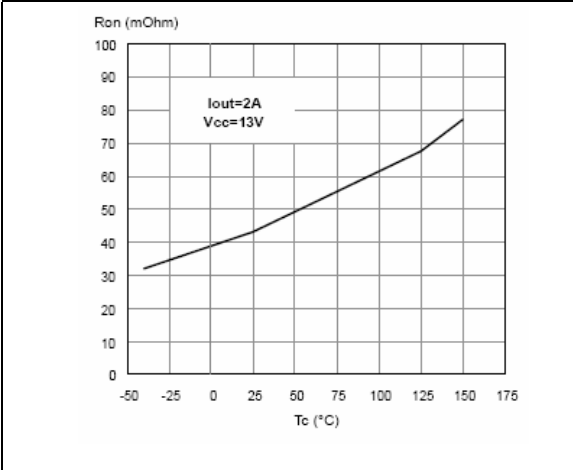

Figure 13. On-state resistance vs V_{CC}

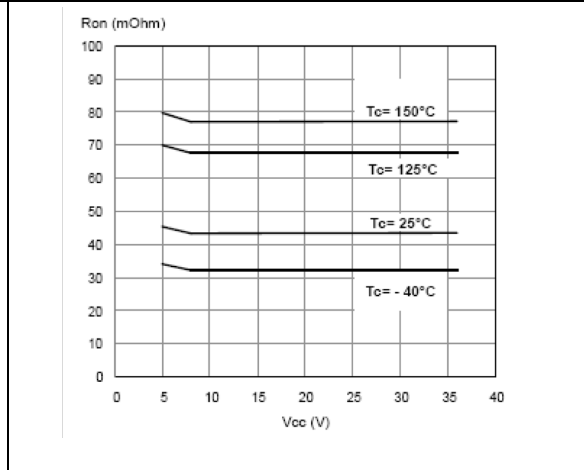

Figure 14. Undervoltage shutdown

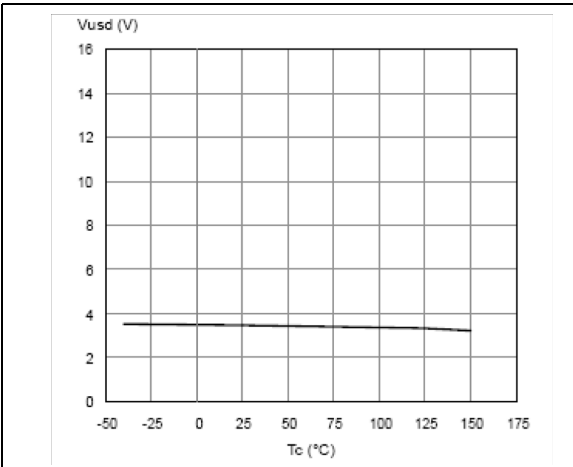

Figure 15. Turn-on voltage slope

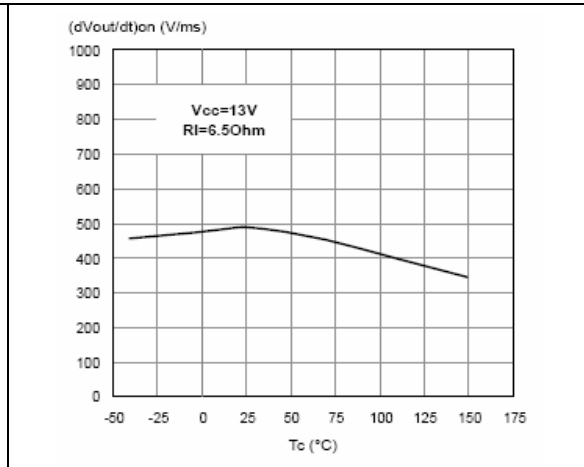

Figure 16. I_{LIMH} vs T_{case}

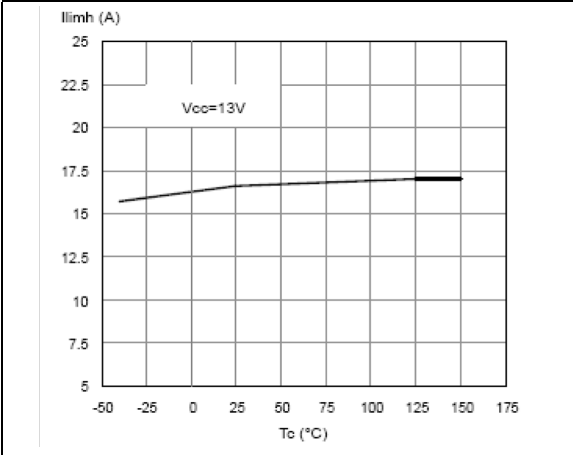
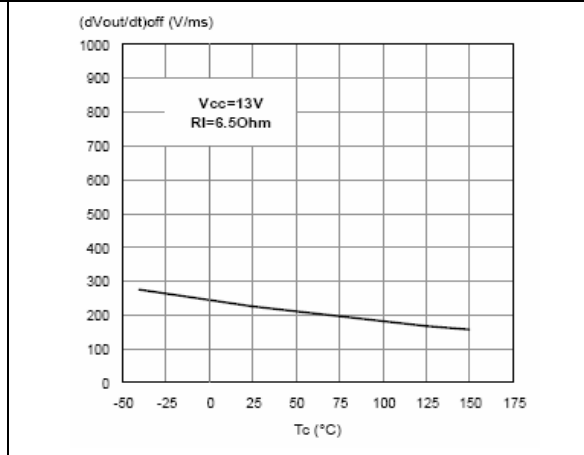

Figure 17. Turn-off voltage slope



2.5 Electrical characteristics for low-side switch

Values specified in this section are for $-40\text{ °C} < T_j < 150\text{ °C}$, unless otherwise specified

Table 12. PowerMOS section - off

Symbol	Parameter	Test conditions	Min.	Typ.	Max.	Unit
V_{CLAMP}	Drain-source voltage clamp	$V_{IN} = 0\text{ V}; I_D = 2\text{ A}$	41	46	52	V
V_{CLTH}	Drain-source threshold voltage clamp	$V_{IN} = 0\text{ V}; I_D = 2\text{ mA}$	36			V
I_{DSS}	Zero input voltage Drain current ($V_{IN} = 0\text{ V}$)	$V_{DS} = 13\text{ V}; V_{IN} = 0\text{ V}; T_j = 25\text{ °C}$	0		3	μA
		$V_{DS} = 13\text{ V}; V_{IN} = 0\text{ V}; T_j = 125\text{ °C}$	0		5	

Table 13. PowerMOS section - On

Symbol	Parameter	Test conditions	Min.	Typ.	Max.	Unit
$R_{DS(on)}$	Static drain-source on-resistance	$V_{IN} = 5\text{ V}; I_D = 2\text{ A}; T_j = 25\text{ °C}$ $V_{IN} = 5\text{ V}; I_D = 2\text{ A}; T_j = 150\text{ °C}$	-	-	50 100	$\text{m}\Omega$

Table 14. Switching ($T_j = 25\text{ °C}$, unless otherwise specified)

Symbol	Parameter	Test conditions	Min.	Typ.	Max.	Unit
$t_{d(on)}$	Turn-on delay time	$R_L = 6.5\ \Omega; V_{CC} = 13\text{ V}$	-	6	-	μs
$t_{d(off)}$	Turn-off delay time	$R_L = 6.5\ \Omega; V_{CC} = 13\text{ V}$	-	20	-	μs
$(dV_{OUT}/dt)_{on}$	Turn-on voltage slope	$R_L = 6.5\ \Omega; V_{CC} = 13\text{ V}$	-	10 (see Figure 15)	-	$\text{V}/\mu\text{s}$
$(dV_{OUT}/dt)_{off}$	Turn-off voltage slope	$R_L = 6.5\ \Omega; V_{CC} = 13\text{ V}$	-	10 (see Figure 17)	-	$\text{V}/\mu\text{s}$
W_{ON}	Switching energy losses during t_{won}	$R_L = 6.5\ \Omega; V_{CC} = 13\text{ V}$	-	0.025	-	mJ
W_{OFF}	Switching energy losses during t_{woff}	$R_L = 6.5\ \Omega; V_{CC} = 13\text{ V}$	-	0.025	-	mJ

Table 15. Source drain diode

Symbol	Parameter	Test conditions	Min.	Typ.	Max.	Unit
$V_{SD}^{(1)}$	Forward on voltage	$I_{SD} = 2\text{ A}; V_{IN} = 0\text{ V}$	-	0.8	-	V

1. Pulsed: Pulse duration = 300 μs , duty cycle 1.5%

Table 16. Input section

Symbol	Parameter	Test conditions	Min.	Typ.	Max.	Unit
I_{ISS}	Supply current from input pin	On-state: $V_{IN} = 5\text{ V}$; $V_{DS} = 0\text{ V}$		30	110	μA
V_{ICL}	Input voltage clamp	$I_S = 1\text{ mA}$	5.5		7	V
		$I_S = -1\text{ mA}$		-0.7		
V_{INTH}	Input voltage threshold	$V_{DS} = V_{IN}$; $I_D = 1\text{ mA}$	1		3.5	V

Table 17. STATUS pin

Symbol	Parameter	Test conditions	Min.	Typ.	Max.	Unit
V_{STAT}	Status low output voltage	$I_{STAT} = 1\text{ mA}$			0.5	V
I_{LSTAT}	Status leakage current	Normal operation, $V_{STAT} = 5\text{ V}$			10	μA
C_{STAT}	STATUS pin input capacitance	Normal operation, $V_{STAT} = 5\text{ V}$			100	pF
V_{STCL}	Status voltage clamp	$I_{STAT} = 1\text{ mA}$	5.5		7	V
		$I_{STAT} = -1\text{ mA}$		-0.7		

Table 18. Protection and diagnostics (-40 °C < T_j < 150 °C, unless otherwise specified)

Symbol	Parameter	Test conditions	Min.	Typ.	Max.	Unit
I_{limH}	DC short-circuit current	$V_{DS} = 13\text{ V}$, $V_{IN} = 5\text{ V}$	19	27	38	A
I_{limL}	Short-circuit current during thermal cycling	$V_{DS} = 13\text{ V}$, $T_R < T_j < T_{TSD}$		11		A
t_{dlim}	Step response current limit	$V_{IN} = 5\text{ V}$, $V_{DS} = 13\text{ V}$		20		μs
T_{TSD}	Over temperature shutdown		150	175	200	°C
T_R	Over temperature reset		135			°C

Table 19. Truth table low-side driver

Conditions	Input	Drain	Status
Normal operation	L	H	H
	H	L	H
Over temperature	L	H	H
	H	H	L

2.6 Electrical characteristics curves for low-side switch

Figure 18. Source diode forward characteristics

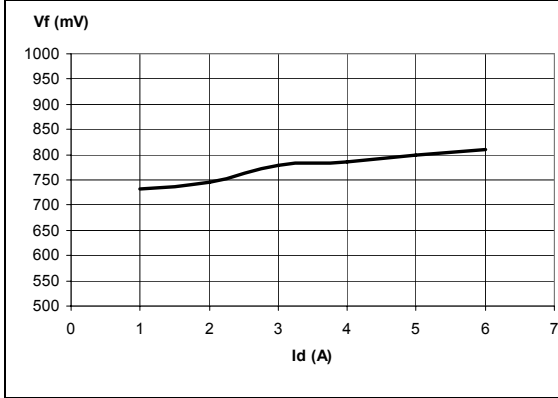

Figure 19. Static drain source on-resistance vs drain current (3 pin)

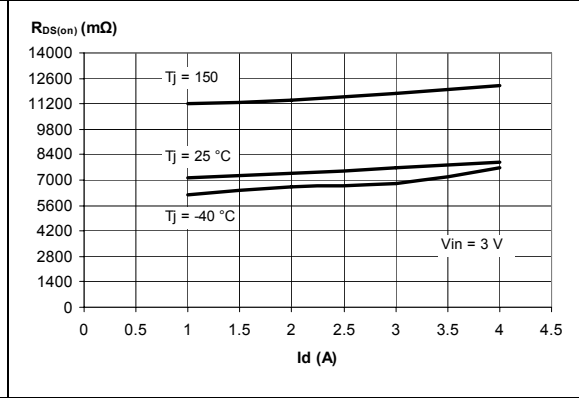

Figure 20. Static drain source on-resistance vs input voltage (3 pin)

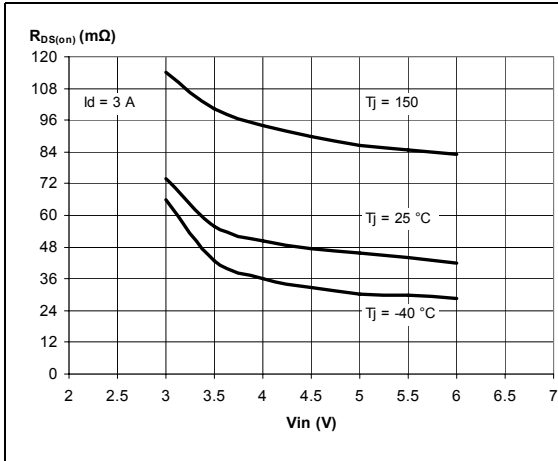

Figure 21. Static drain source on-resistance vs drain current

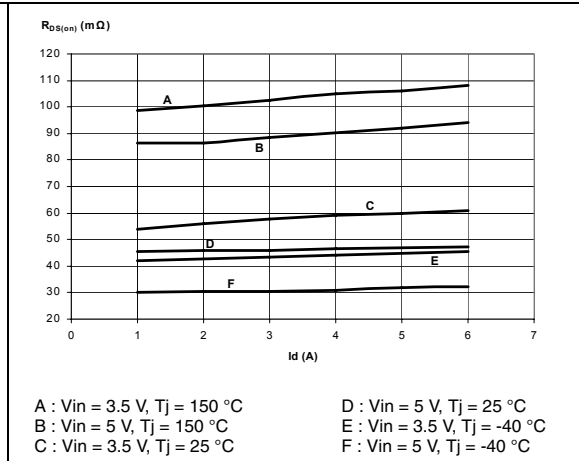

Figure 22. Transfer characteristics

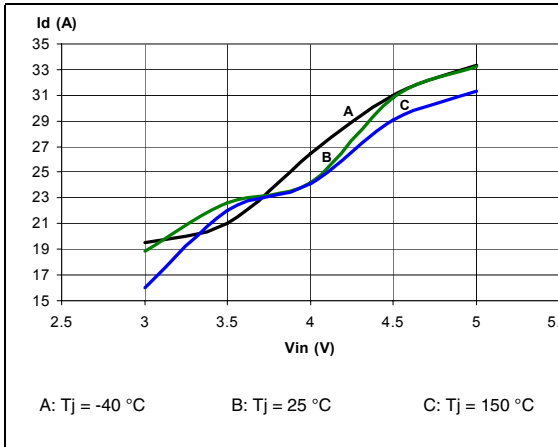

Figure 23. Output characteristics

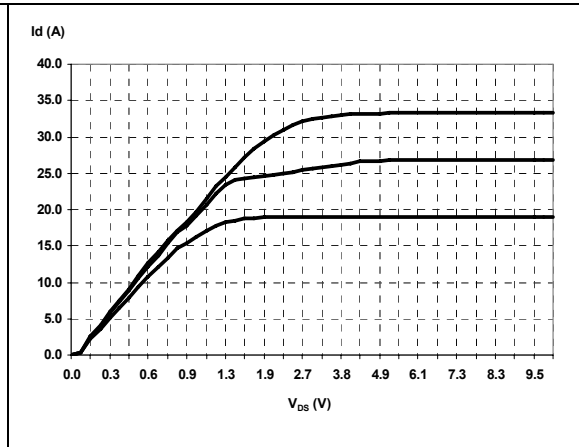

Figure 24. Normalized on-resistance vs temperature

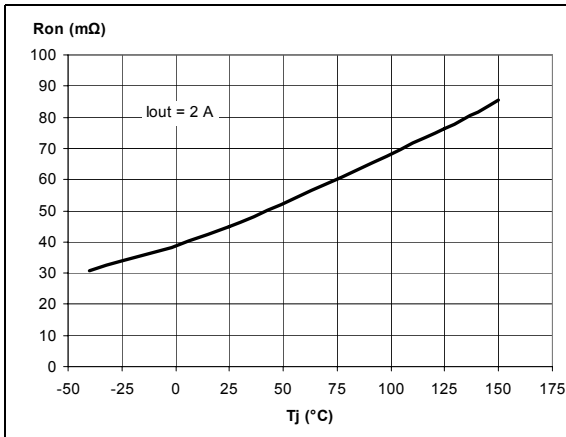
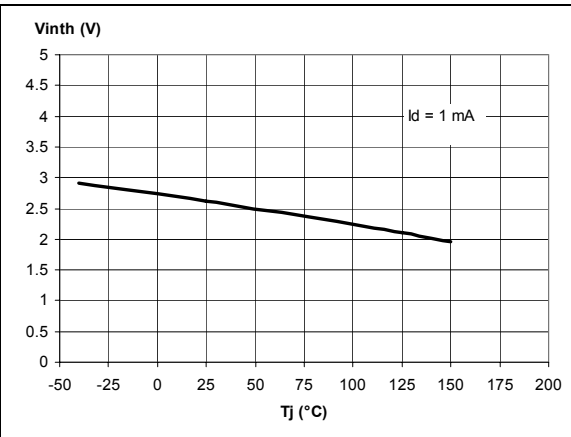
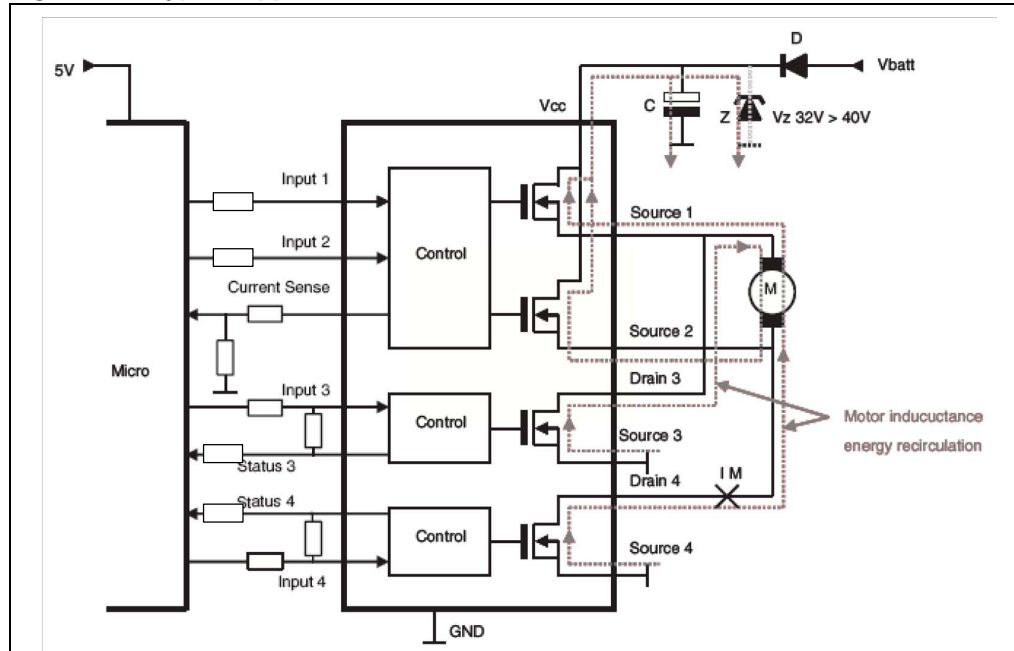

Figure 25. Normalized input threshold vs temperature



3 Application information

Figure 26. Typical application schematic



Mostly motor bridge drivers use a reverse battery protection diode (D) inside supply rail. This diode prevents a reverse current flow back to Vbatt in case the bridge gets disabled via the logic inputs while motor inductance still carries energy. In order to prevent a hazardous overvoltage at circuit supply terminal (Vcc), a blocking capacitor (C) is needed to limit the voltage overshoot. As basic orientation, 50 μF per 1 A load current is recommended. In alternative, also a Zener protection (Z) is suitable.

Even if a reverse polarity diode is not present, it is recommended to use a capacitor or zener at Vcc because a similar problem appears in case supply terminal of the module has intermittent electrical contact to the battery or gets disconnected while motor is operating.

Figure 27. Recommended motor operation

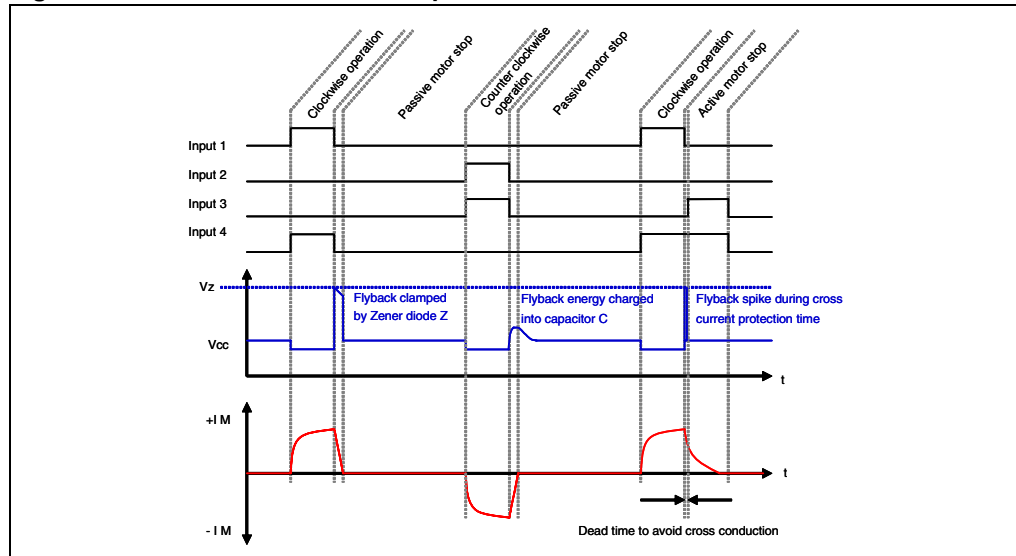
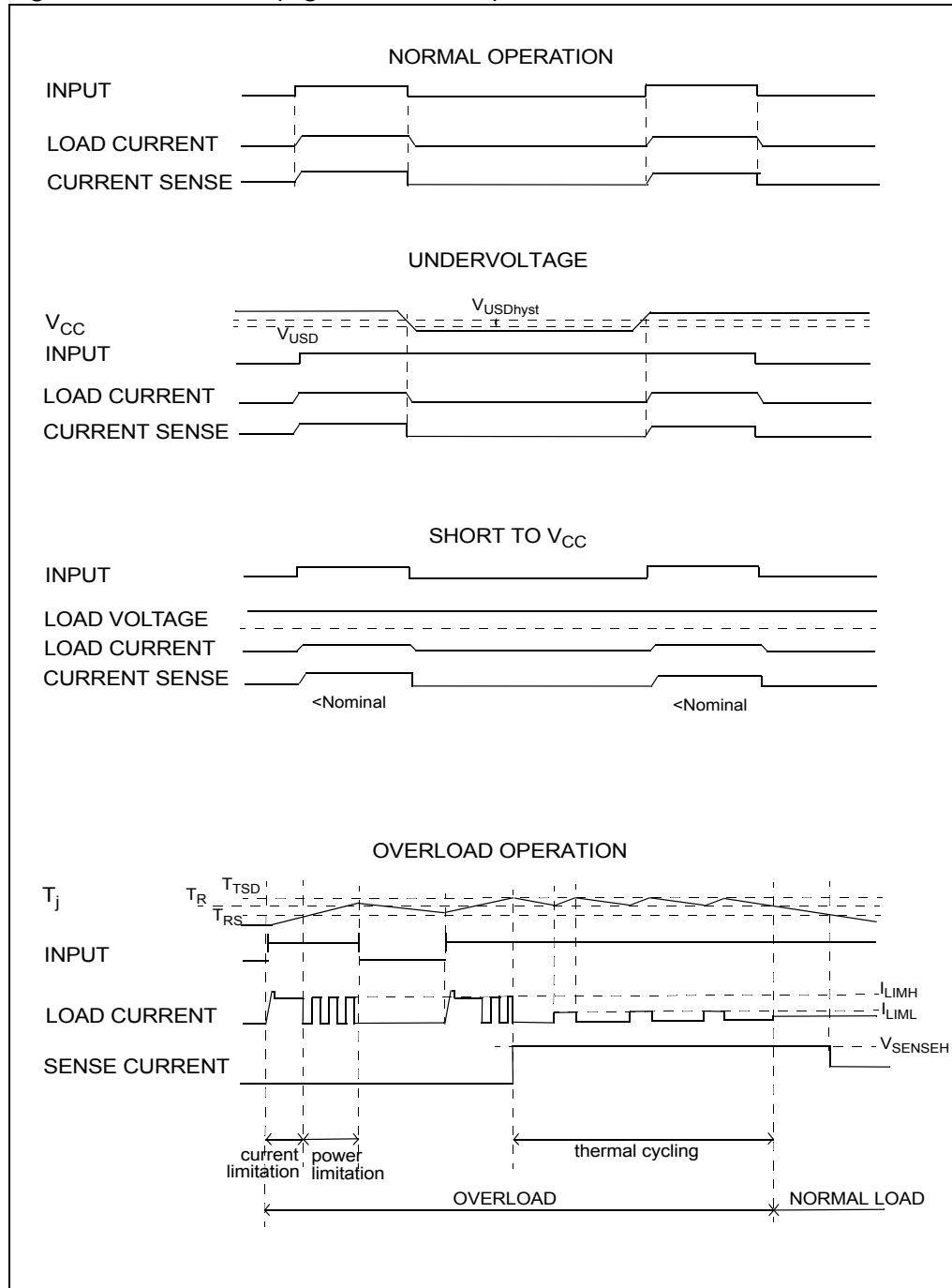
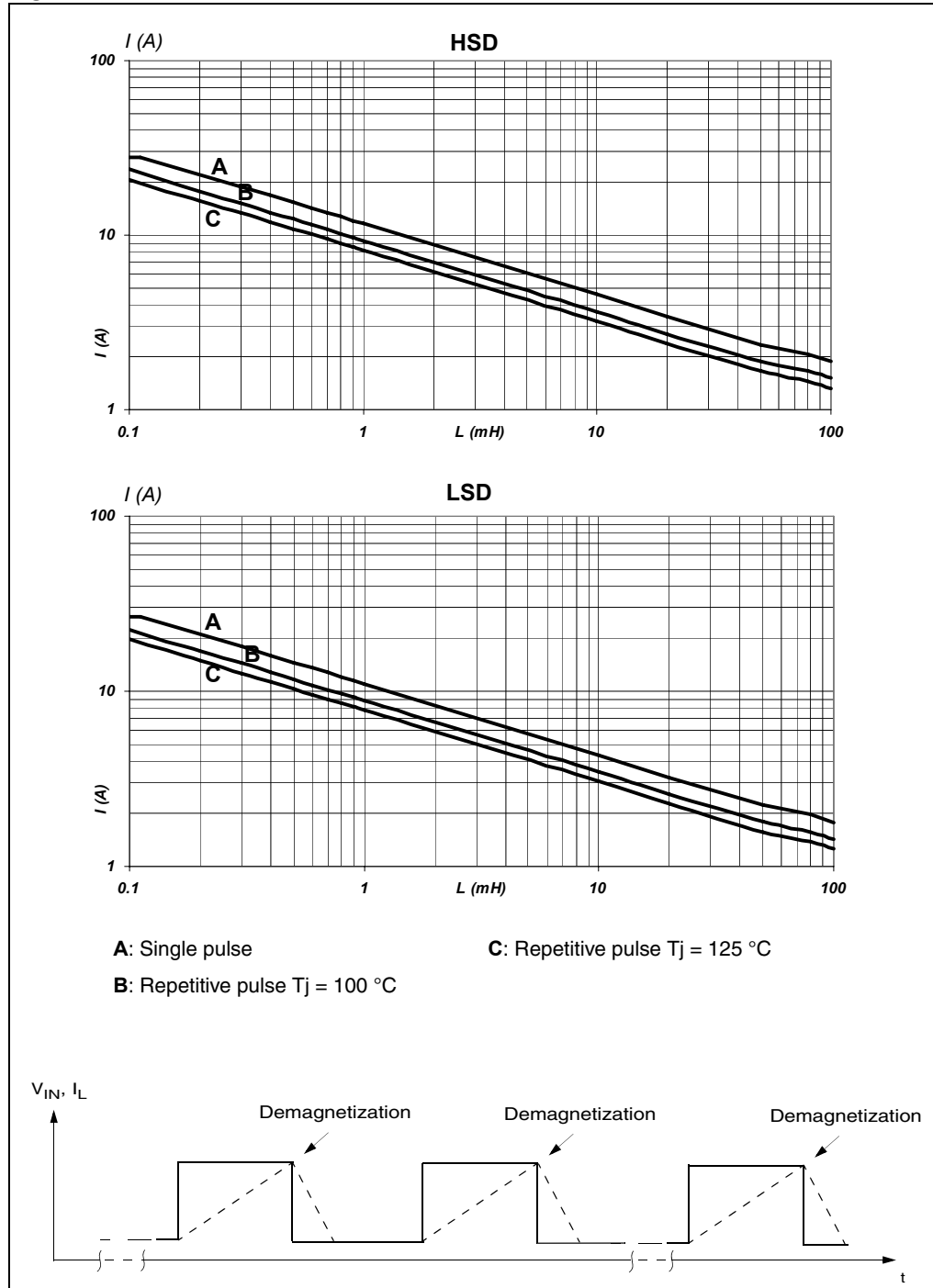

Figure 28. Waveforms (high-side switches)



3.1 Maximum demagnetization energy ($V_{CC} = 13.5\text{ V}$)

Figure 29. Maximum turn-off current vs load inductance⁽¹⁾



1. Values are generated with $R_L = 0\ \Omega$
 In the case of repetitive pulses, $T_{j\text{start}}$ (at beginning of each demagnetization) of every pulse must not exceed the temperature specified above for curves B and C.

4 Package and PC board thermal data

4.1 SO-28 thermal data

Figure 30. SO-28 PC board⁽¹⁾

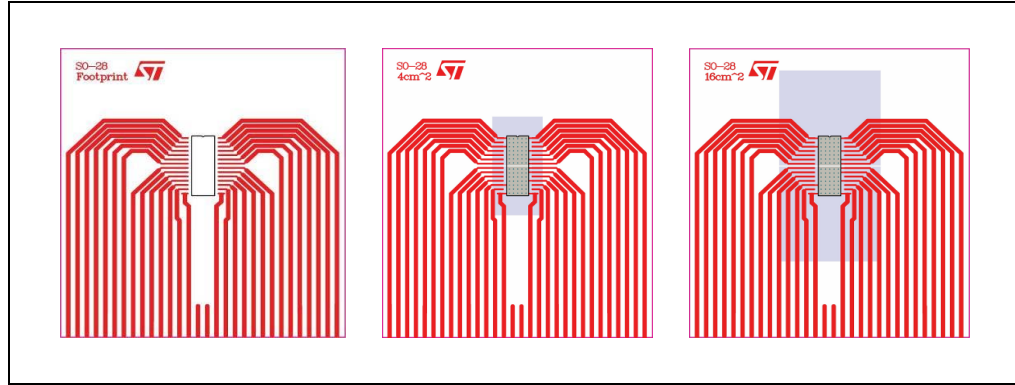

1. Layout condition of Rth and Zth measurements (Board finish thickness 1.6 mm +/- 10%; Board double layers; Board dimension 77x86; Board Material FR4; Cu thickness 0.070mm (front and back side); Thermal vias separation 1.2 mm; Thermal via diameter 0.3 mm +/- 0.08 mm; Cu thickness on vias 0.025 mm).

Figure 31. Chipset configuration

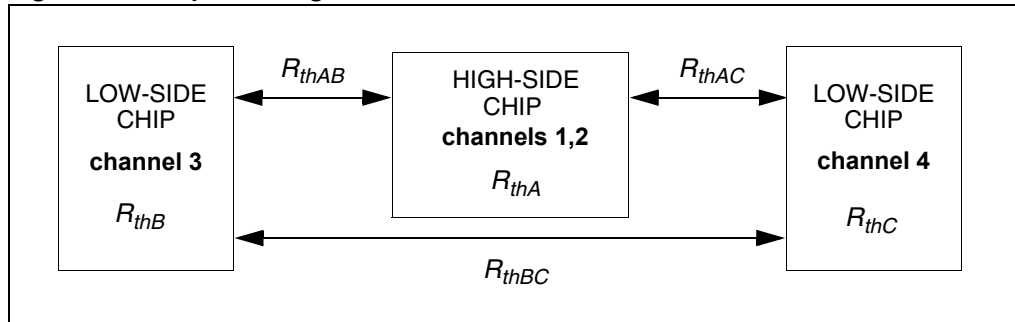
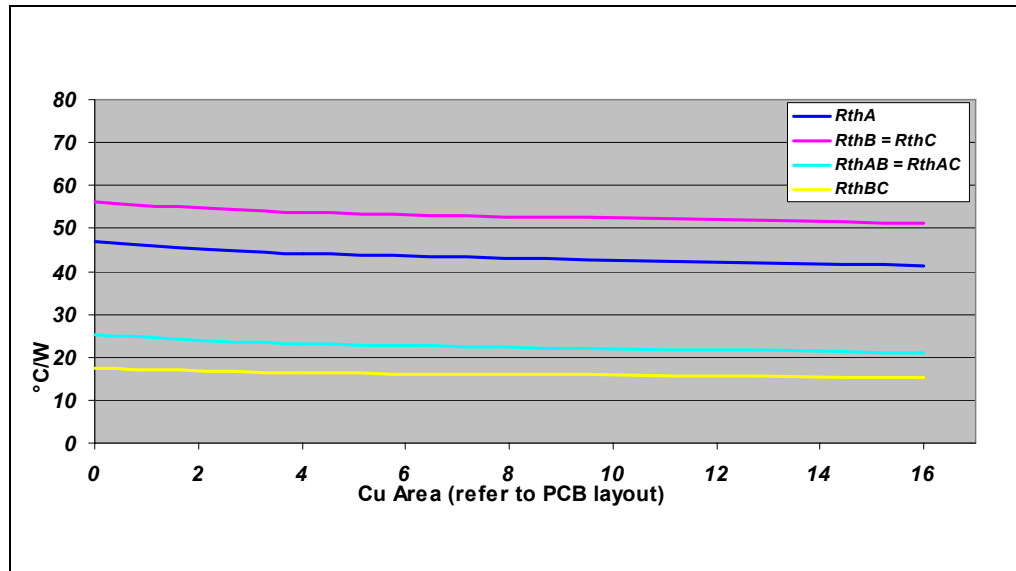

Figure 32. Auto and mutual Rthj-amb vs PCB copper area in open box free air condition⁽¹⁾



1. See Figure 31. For more detailed information see Table 20 and Table 21.

Table 20. Thermal calculations in clockwise and anti-clockwise operation in steady-state mode

HS ₁	HS ₂	LS ₃	LS ₄	T _{JHS12}	T _{JLS3}	T _{JLS4}
On	Off	Off	On	$P_{dHS1} \times R_{thHS} + P_{dLS4} \times R_{thHLSLS} + T_{amb}$	$P_{dHS1} \times R_{thHLSLS} + P_{dLS4} \times R_{thLSLS} + T_{amb}$	$P_{dHS1} \times R_{thHLSLS} + P_{dLS4} \times R_{thLS} + T_{amb}$
Off	On	On	Off	$P_{dHS2} \times R_{thHS} + P_{dLS3} \times R_{thHLSLS} + T_{amb}$	$P_{dHS2} \times R_{thHLSLS} + P_{dLS3} \times R_{thLS} + T_{amb}$	$P_{dHS2} \times R_{thHLSLS} + P_{dLS3} \times R_{thLSLS} + T_{amb}$

Table 21. Thermal resistances definitions⁽¹⁾

$R_{thHS} = R_{thHS1} = R_{thHS2}$	High-side chip thermal resistance junction-to-ambient (HS ₁ or HS ₂ in on-state)
$R_{thLS} = R_{thLS3} = R_{thLS4}$	Low-side chip thermal resistance junction-to-ambient
$R_{thHLSLS} = R_{thHS1LS4} = R_{thHS2LS3}$	Mutual thermal resistance junction-to-ambient between high-side and low-side chips
$R_{thLSLS} = R_{thLS3LS4}$	Mutual thermal resistance junction-to-ambient between low-side chips

1. values dependent on PCB heatsink area.

Table 22. Single pulse thermal impedance definitions⁽¹⁾

Z_{thHS}	High-side chip thermal impedance junction-to-ambient
$Z_{thLS} = Z_{thLS3} = Z_{thLS4}$	Low-side chip thermal impedance junction-to-ambient
$Z_{thHSLS} = Z_{thHS12LS3} = Z_{thHS12LS4}$	Mutual thermal impedance junction-to-ambient between high-side and low-side chips
$Z_{thLSLS} = Z_{thLS3LS4}$	Mutual thermal impedance junction-to-ambient between low-side chips

1. values dependent on PCB heatsink area.

Table 23. Thermal calculations in transient mode⁽¹⁾

T_{jHS12}	$Z_{thHS} \times P_{dHS12} + Z_{thHSLS} \times (P_{dLS3} + P_{dLS4}) + T_{amb}$
T_{jLS3}	$Z_{thHSLS} \times P_{dHS12} + Z_{thLS} \times P_{dLS3} + Z_{thLSLS} \times P_{dLS4} + T_{amb}$
T_{jLS4}	$Z_{thHSLS} \times P_{dHS12} + Z_{thLSLS} \times P_{dLS3} + Z_{thLS} \times P_{dLS4} + T_{amb}$

1. Calculation is valid in any dynamic operating condition. Pd values set by user.

Figure 33. SO-28 HSD thermal impedance junction-ambient single pulse

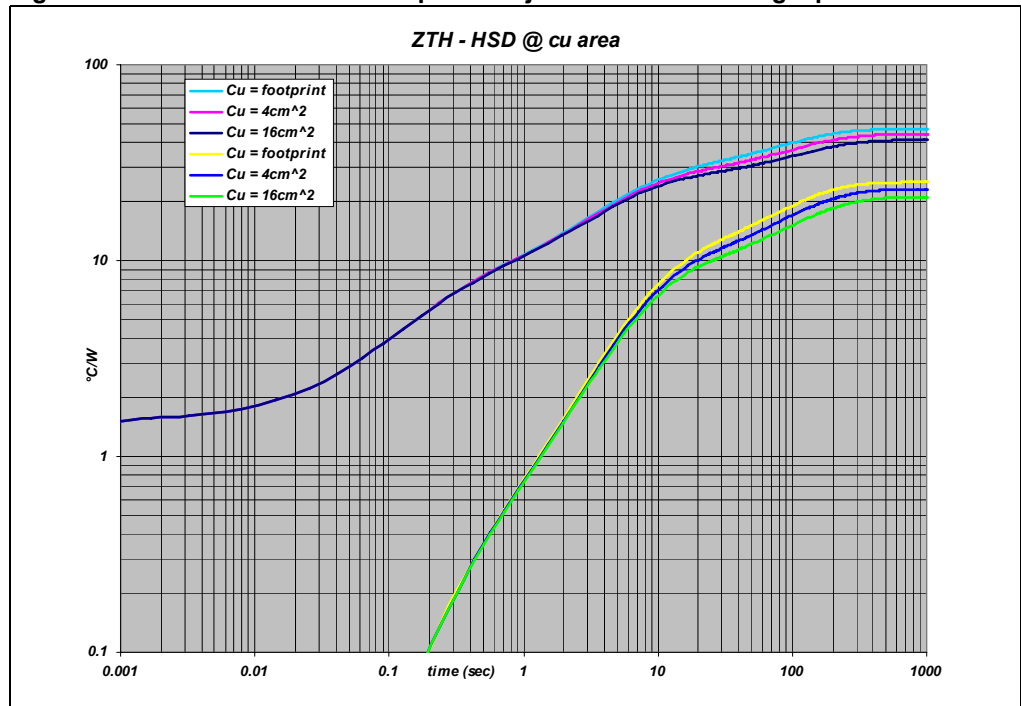
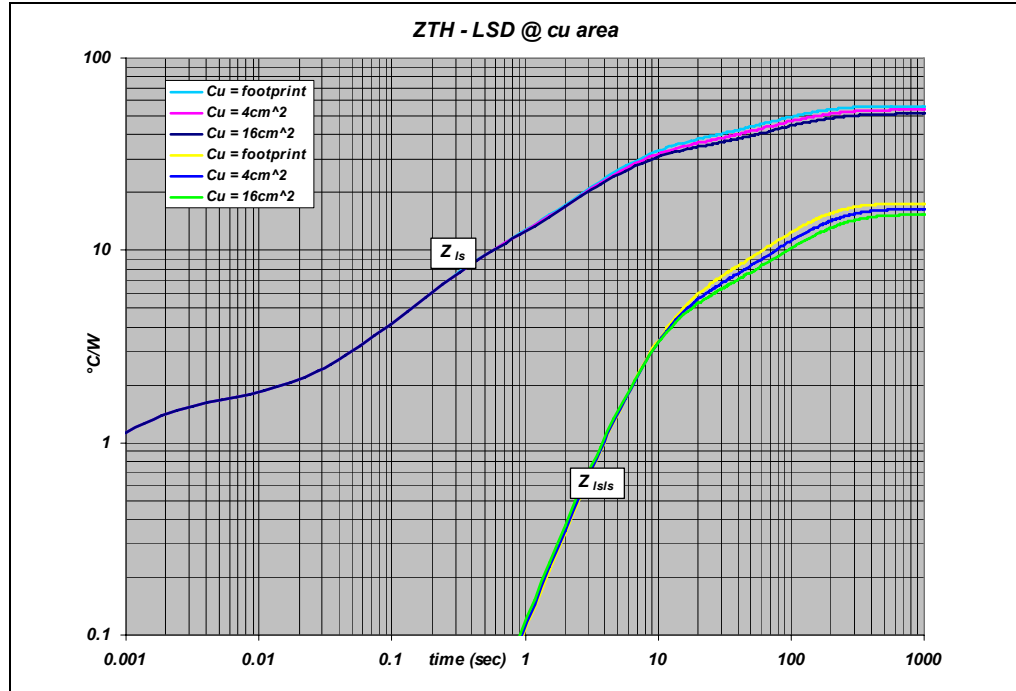

Figure 34. SO-28 LSD thermal impedance junction-ambient single pulse



Equation 1: Pulse Calculation Formula

$$Z_{TH\delta} = R_{TH} \cdot \delta + Z_{THtp}(1 - \delta)$$

where $\delta = t_p/T$

Figure 35. Thermal fitting model of an H-bridge in SO-28

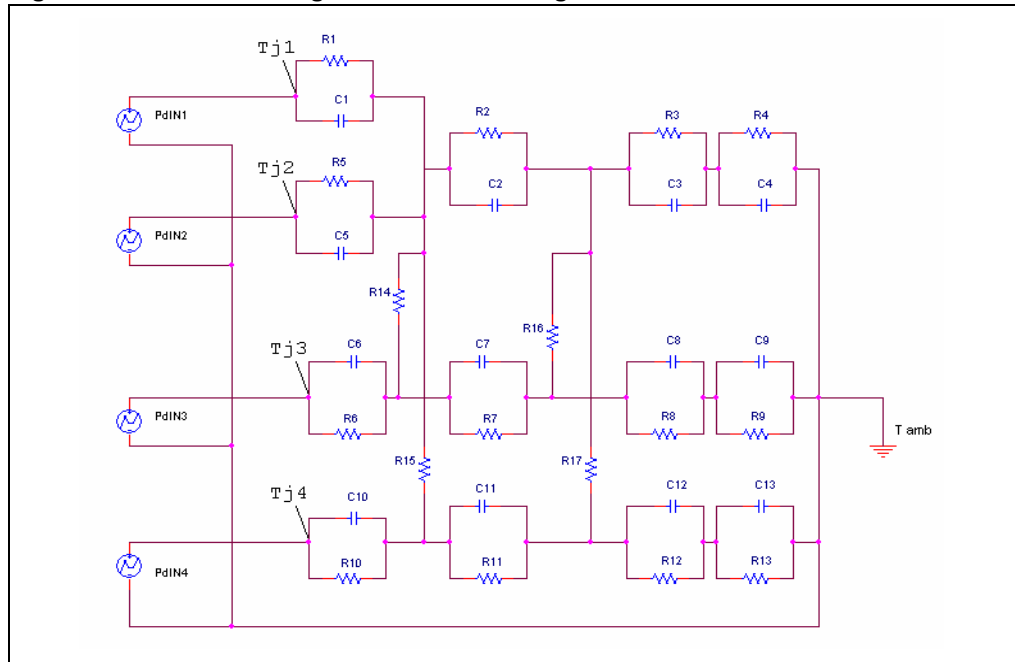

Table 24. Thermal parameters⁽¹⁾

Area/island (cm ²)	FP	4	16
R1=R5=R6=R10 (°C/W)	1.5		
R2=R7=R11 (°C/W)	5.5		
R3 (°C/W)	36	34	32
R4 (°C/W)	55	43	36
R8=R12 (°C/W)	40	38	36
R9=R13 (°C/W)	54	52	50
R14=R15 (°C/W)	120		
R16=R17 (°C/W)	200		
R18 (°C/W)	400	350	300
C1=C5 (W·s/°C)	0.00025		
C2=C7=C11 (W·s/°C)	0.04		
C3 (W·s/°C)	0.2		
C4 (W·s/°C)	2.2	3	4
C6=C10 (W·s/°C)	0.00075		
C8=C12 (W·s/°C)	0.15		
C9=C13 (W·s/°C)	1.6	1.8	2

1. A blank space means that the value is the same as the previous one

5 Package and packing information

5.1 ECOPACK[®] package

In order to meet environmental requirements, ST offers these devices in different grades of ECOPACK[®] packages, depending on their level of environmental compliance. ECOPACK[®] specifications, grade definitions and product status are available at: www.st.com. ECOPACK[®] is an ST trademark.

5.2 Package mechanical data

Figure 36. SO-28 package dimensions

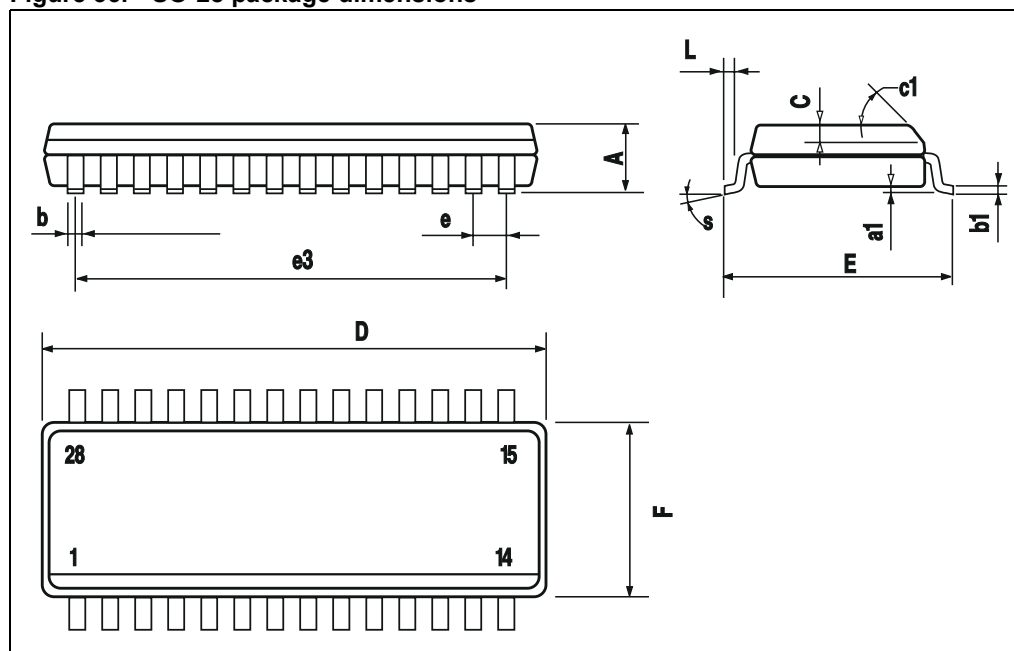

Table 25. SO-28 mechanical data

Symbol	Millimeters		
	Min.	Typ.	Max.
A			2.65
a1	0.10		0.30
b	0.35		0.49
b1	0.23		0.32
C		0.50	
c1	45° (typ.)		
D	17.7		18.1
E	10.00		10.65
e		1.27	
e3		16.51	
F	7.40		7.60
L	0.40		1.27
S	8° (max.)		

5.3 Packing information

Figure 37. SO-28 tube shipment (no suffix)

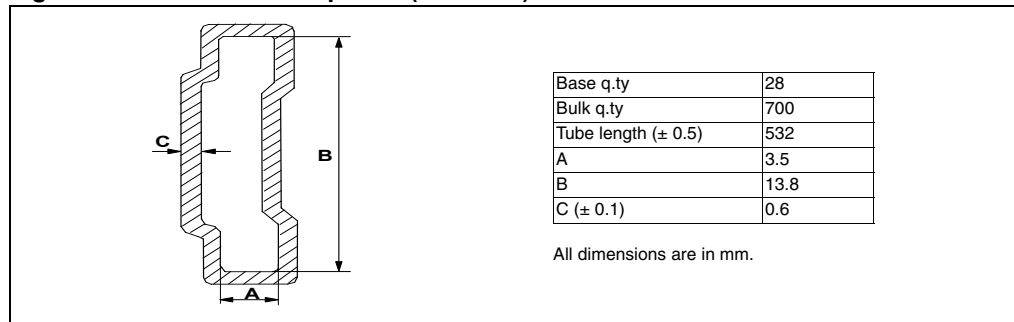
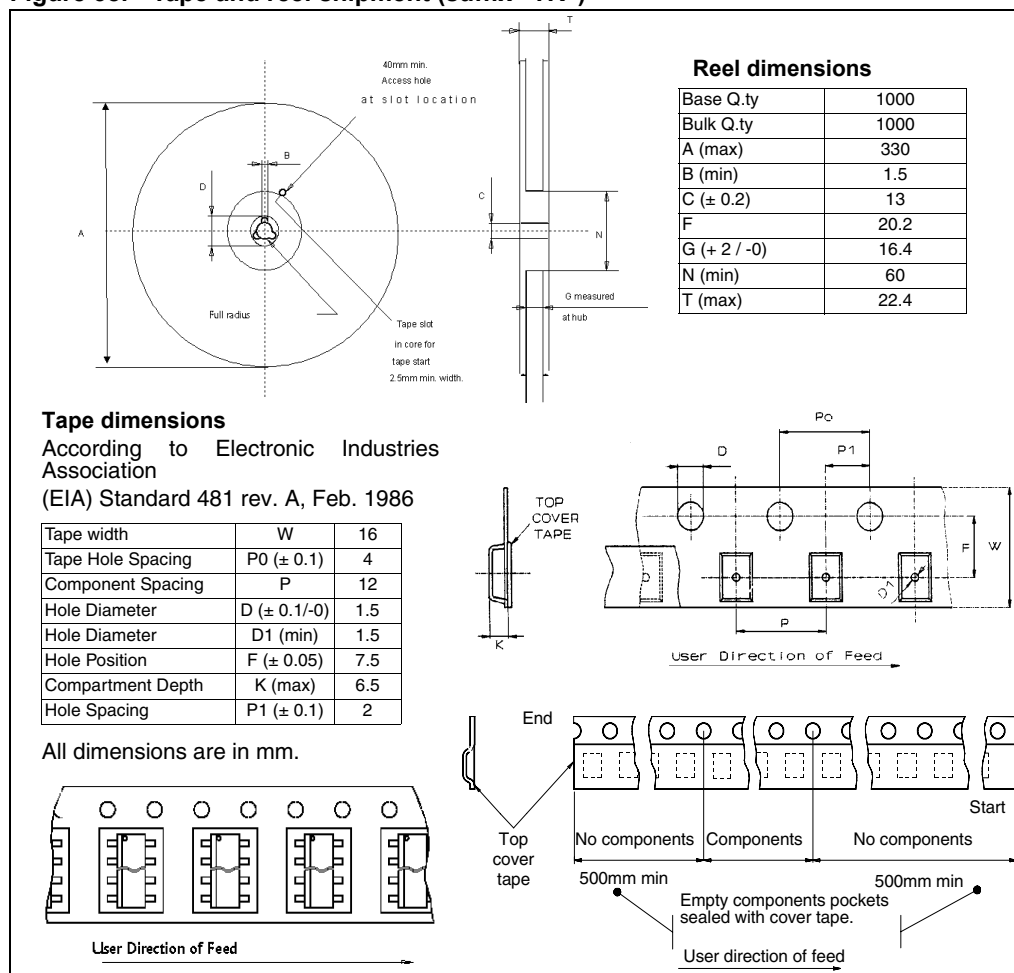

Figure 38. Tape and reel shipment (suffix “TR”)



6 Revision history

Table 26. Document revision history

Date	Revision	Changes
30-Jul-2009	1	Initial release.
10-Sep-2009	2	Updated following figures: <ul style="list-style-type: none"> – <i>Figure 29: Maximum turn-off current vs load inductance⁽¹⁾</i> – <i>Figure 32: Auto and mutual Rthj-amb vs PCB copper area in open box free air condition⁽¹⁾</i> – <i>Figure 33: SO-28 HSD thermal impedance junction-ambient single pulse</i> – <i>Figure 34: SO-28 LSD thermal impedance junction-ambient single pulse</i> Updated <i>Table 24: Thermal parameters</i> .
14-Jan-2010	3	Updated <i>Figure 26: Typical application schematic</i> .

Please Read Carefully:

Information in this document is provided solely in connection with ST products. STMicroelectronics NV and its subsidiaries ("ST") reserve the right to make changes, corrections, modifications or improvements, to this document, and the products and services described herein at any time, without notice.

All ST products are sold pursuant to ST's terms and conditions of sale.

Purchasers are solely responsible for the choice, selection and use of the ST products and services described herein, and ST assumes no liability whatsoever relating to the choice, selection or use of the ST products and services described herein.

No license, express or implied, by estoppel or otherwise, to any intellectual property rights is granted under this document. If any part of this document refers to any third party products or services it shall not be deemed a license grant by ST for the use of such third party products or services, or any intellectual property contained therein or considered as a warranty covering the use in any manner whatsoever of such third party products or services or any intellectual property contained therein.

UNLESS OTHERWISE SET FORTH IN ST'S TERMS AND CONDITIONS OF SALE ST DISCLAIMS ANY EXPRESS OR IMPLIED WARRANTY WITH RESPECT TO THE USE AND/OR SALE OF ST PRODUCTS INCLUDING WITHOUT LIMITATION IMPLIED WARRANTIES OF MERCHANTABILITY, FITNESS FOR A PARTICULAR PURPOSE (AND THEIR EQUIVALENTS UNDER THE LAWS OF ANY JURISDICTION), OR INFRINGEMENT OF ANY PATENT, COPYRIGHT OR OTHER INTELLECTUAL PROPERTY RIGHT.

UNLESS EXPRESSLY APPROVED IN WRITING BY AN AUTHORIZED ST REPRESENTATIVE, ST PRODUCTS ARE NOT RECOMMENDED, AUTHORIZED OR WARRANTED FOR USE IN MILITARY, AIR CRAFT, SPACE, LIFE SAVING, OR LIFE SUSTAINING APPLICATIONS, NOR IN PRODUCTS OR SYSTEMS WHERE FAILURE OR MALFUNCTION MAY RESULT IN PERSONAL INJURY, DEATH, OR SEVERE PROPERTY OR ENVIRONMENTAL DAMAGE. ST PRODUCTS WHICH ARE NOT SPECIFIED AS "AUTOMOTIVE GRADE" MAY ONLY BE USED IN AUTOMOTIVE APPLICATIONS AT USER'S OWN RISK.

Resale of ST products with provisions different from the statements and/or technical features set forth in this document shall immediately void any warranty granted by ST for the ST product or service described herein and shall not create or extend in any manner whatsoever, any liability of ST.

ST and the ST logo are trademarks or registered trademarks of ST in various countries.

Information in this document supersedes and replaces all information previously supplied.

The ST logo is a registered trademark of STMicroelectronics. All other names are the property of their respective owners.

© 2010 STMicroelectronics - All rights reserved

STMicroelectronics group of companies

Australia - Belgium - Brazil - Canada - China - Czech Republic - Finland - France - Germany - Hong Kong - India - Israel - Italy - Japan - Malaysia - Malta - Morocco - Philippines - Singapore - Spain - Sweden - Switzerland - United Kingdom - United States of America

www.st.com