



VNN1NV04P-E, VNS1NV04P-E

OMNIFET II fully autoprotected Power MOSFET

Features

Parameter	Symbol	Value
Max on-state resistance (per ch.)	R_{ON}	250 m Ω
Current limitation (typ)	I_{LIMH}	1.7 A
Drain-source clamp voltage	V_{CLAMP}	40 V

- Linear current limitation
- Thermal shutdown
- Short circuit protection
- Integrated clamp
- Low current drawn from input pin
- Diagnostic feedback through input pin
- ESD protection
- Direct access to the gate of the Power MOSFET (analog driving)
- Compatible with standard Power MOSFET

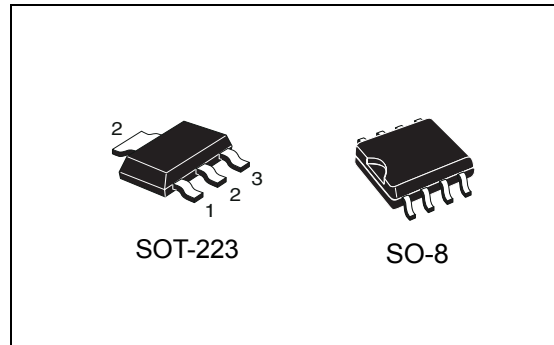

Description

The VNN1NV04P-E, VNS1NV04P-E are monolithic devices designed in STMicroelectronics VIPower M0-3 Technology, intended for replacement of standard Power MOSFETs from DC up to 50 kHz applications. Built in thermal shutdown, linear current limitation and overvoltage clamp protect the chip in harsh environments.

Fault feedback can be detected by monitoring the voltage at the input pin.

Table 1. Device summary

Package	Order codes	
	Tube	Tape and reel
SOT-223	VNN1NV04P-E	VNN1NV04PTR-E
SO-8	VNS1NV04P-E	VNS1NV04PTR-E

Contents

1	Block diagram and pin description	5
2	Electrical specifications	6
2.1	Absolute maximum ratings	6
2.2	Thermal data	7
2.3	Electrical characteristics	7
2.4	Electrical characteristics curves	12
3	Protection features	16
4	Package and PCB thermal data	17
4.1	SOT-223 thermal data	17
4.2	SO-8 thermal data	19
5	Package and packing information	22
5.1	SOT-223 mechanical data	22
5.2	SO8 mechanical data	23
5.3	SOT-223 packing information	25
5.4	SO8 packing information	26
6	Revision history	27

List of tables

Table 1.	Device summary	1
Table 2.	Absolute maximum ratings	6
Table 3.	Thermal data.	7
Table 4.	Electrical characteristics	7
Table 5.	SOT-223 thermal parameter.	18
Table 6.	SO-8 thermal parameter	20
Table 7.	SO-8 mechanical data	23
Table 8.	Document revision history	27

List of figures

Figure 1.	Block diagram	5
Figure 2.	Configuration diagram (top view)	5
Figure 3.	Current and voltage conventions	6
Figure 4.	Switching time test circuit for resistive load	9
Figure 5.	Test circuit for diode recovery times	10
Figure 6.	Unclamped inductive load test circuits	10
Figure 7.	Input charge test circuit.	11
Figure 8.	Unclamped inductive waveforms	11
Figure 9.	Source-drain diode forward characteristics	12
Figure 10.	Static drain-source on resistance	12
Figure 11.	Derating curve	12
Figure 12.	Static drain-source on resistance vs input voltage (part 1/2)	12
Figure 13.	Static drain-source on resistance vs input voltage (part 2/2)	12
Figure 14.	Transconductance	12
Figure 15.	Static drain-source on resistance vs I_d	13
Figure 16.	Transfer characteristics	13
Figure 17.	Turn-on current slope (part 1/2)	13
Figure 18.	Turn-on current slope (part 2/2)	13
Figure 19.	Input voltage vs input charge	13
Figure 20.	Turn-off drain source voltage slope (part 1/2)	13
Figure 21.	Turn-off drain-source voltage slope (part 2/2)	14
Figure 22.	Capacitance variations	14
Figure 23.	Switching time resistive load (part 1/2)	14
Figure 24.	Switching time resistive load (part 2/2)	14
Figure 25.	Output characteristics	14
Figure 26.	Normalized on resistance vs temperature	14
Figure 27.	Normalized input threshold voltage vs temperature	15
Figure 28.	Normalized current limit vs junction temperature	15
Figure 29.	Step response current limit	15
Figure 30.	SOT-223 PC board	17
Figure 31.	SOT-223 $R_{thj-amb}$ vs PCB copper area in open box free air condition	17
Figure 32.	SOT-223 thermal impedance junction ambient single pulse	18
Figure 33.	SOT-223 thermal fitting model of a single channel	18
Figure 34.	SO-8 PC board	19
Figure 35.	SO-8 $R_{thj-amb}$ vs PCB copper area in open box free air condition	19
Figure 36.	SO-8 thermal impedance junction ambient single pulse	20
Figure 37.	SO-8 thermal fitting model of a single channel	20
Figure 38.	SOT-223 mechanical data and package outline	22
Figure 39.	SO-8 package dimension	24
Figure 40.	SOT-223 tape and reel shipment (suffix "TR")	25
Figure 41.	SO-8 tube shipment (no suffix)	26
Figure 42.	SO-8 tape and reel shipment (suffix "TR")	26

1 Block diagram and pin description

Figure 1. Block diagram

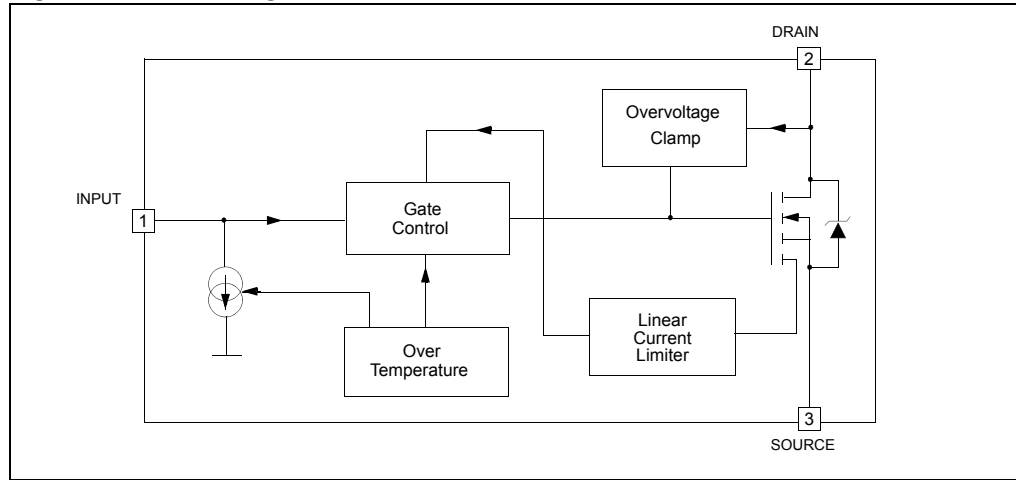
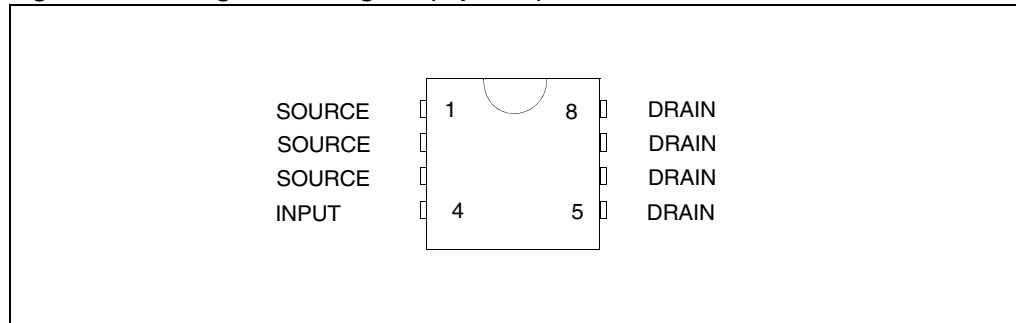

Figure 2. Configuration diagram (top view) (a)



a. For the pins configuration related to SOT-223 see outline at page 1.

2 Electrical specifications

Figure 3. Current and voltage conventions

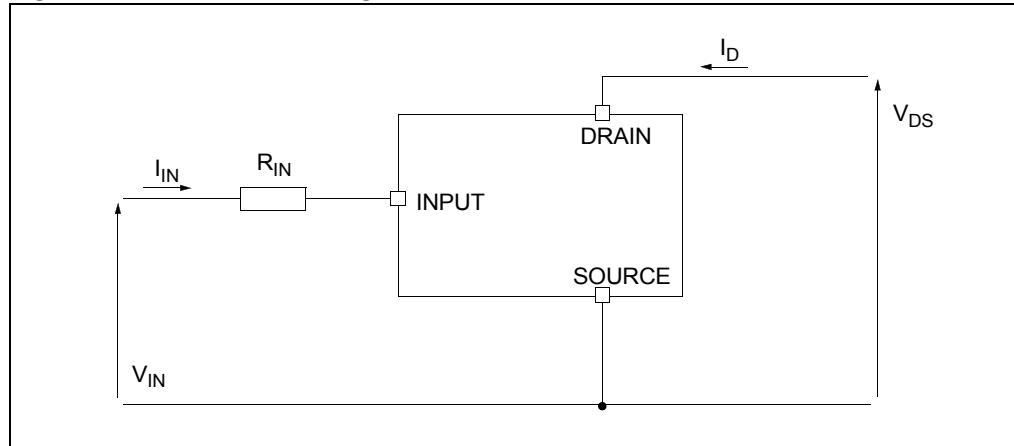

2.1 Absolute maximum ratings

Stress values that exceed those listed in the “Absolute maximum ratings” table can cause permanent damage to the device. These are stress ratings only, and operation of the device at these, or any other conditions greater than those, indicated in the operating sections of this specification is not implied. Exposure to absolute maximum rating conditions for extended periods may affect device reliability. Refer also to the STMicroelectronics sure program and other relevant quality documents.

Table 2. Absolute maximum ratings

Symbol	Parameter	Value		Unit
		SOT-223	SO-8	
V_{DSn}	Drain-source voltage ($V_{INn}=0$ V)	Internally clamped		V
V_{INn}	Input voltage	Internally clamped		V
I_{INn}	Input current	+/-20		mA
$R_{IN\ MINn}$	Minimum input series impedance	330		Ω
I_{Dn}	Drain current	Internally limited		A
I_{Rn}	Reverse DC output current	-3		A
V_{ESD1}	Electrostatic discharge ($R=1.5$ K Ω , $C=100$ pF)	4000		V
V_{ESD2}	Electrostatic discharge on output pins only ($R=330$ Ω , $C=150$ pF)	16500		V
P_{tot}	Total dissipation at $T_c=25$ °C	7	8.3	W
T_j	Operating junction temperature	Internally limited		°C
T_c	Case operating temperature	Internally limited		°C
T_{stg}	Storage temperature	-55 to 150		°C

2.2 Thermal data

Table 3. Thermal data

Symbol	Parameter	Max value		Unit
		SOT-223	SO-8	
$R_{thj-case}$	Thermal resistance junction-case	18		°C/W
$R_{thj-lead}$	Thermal resistance junction-lead		15	°C/W
$R_{thj-amb}$	Thermal resistance junction-ambient	70 ⁽¹⁾	65 ⁽¹⁾	°C/W

1. When mounted on a standard single-sided FR4 board with 50 mm² of Cu (at least 35 μm thick) connected to all DRAIN pins

2.3 Electrical characteristics

Table 4. Electrical characteristics

Symbol	Parameter	Test conditions	Min	Typ	Max	Unit
Off (-40 °C < T_j < 150 °C, unless otherwise specified)						
V_{CLAMP}	Drain-source clamp voltage	$V_{IN}=0\text{ V}; I_D=0.5\text{ A}$	40	45	55	V
V_{CLTH}	Drain-source clamp threshold voltage	$V_{IN}=0\text{ V}; I_D=2\text{ mA}$	36			V
V_{INTH}	Input threshold voltage	$V_{DS}=V_{IN}; I_D=1\text{ mA}$	0.5		2.5	V
I_{ISS}	Supply current from input pin	$V_{DS}=0\text{ V}; V_{IN}=5\text{ V}$		100	150	μA
V_{INCL}	Input-source clamp voltage	$I_{IN}=1\text{ mA}$ $I_{IN}=-1\text{ mA}$	6 -1.0	6.8	8 -0.3	V
I_{DSS}	Zero input voltage drain current ($V_{IN}=0\text{ V}$)	$V_{DS}=13\text{ V}; V_{IN}=0\text{ V}; T_j=25\text{ °C}$ $V_{DS}=25\text{ V}; V_{IN}=0\text{ V}$			30 75	μA
On (-40 °C < T_j < 150 °C, unless otherwise specified)						
$R_{DS(on)}$	Static drain-source on resistance	$V_{IN}=5\text{ V}; I_D=0.5\text{ A}; T_j=25\text{ °C}$ $V_{IN}=5\text{ V}; I_D=0.5\text{ A}$			250 500	mΩ
Dynamic (T_j=25 °C, unless otherwise specified)						
$g_{fs}^{(1)}$	Forward transconductance	$V_{DD}=13\text{ V}; I_D=0.5\text{ A}$		2		S
C_{OSS}	Output capacitance	$V_{DS}=13\text{ V}; f=1\text{ MHz}; V_{IN}=0\text{ V}$		90		pF
Switching (T_j=25 °C, unless otherwise specified)						
$t_{d(on)}$	Turn-on delay time	$V_{DD}=15\text{ V}; I_D=0.5\text{ A}$ $V_{gen}=5\text{ V}; R_{gen}=R_{IN\text{ MIN}}=330\text{ Ω}$ (see Figure 4)		70	200	ns
t_r	Rise time			170	500	ns
$t_{d(off)}$	Turn-off delay time			350	1000	ns
t_f	Fall time			200	600	ns

Table 4. Electrical characteristics (continued)

Symbol	Parameter	Test conditions	Min	Typ	Max	Unit	
$t_{d(on)}$	Turn-on delay time	$V_{DD}=15\text{ V}$; $I_D=0.5\text{ A}$ $V_{gen}=5\text{ V}$; $R_{gen}=2.2\text{ K}\Omega$ (see Figure 4)		0.25	1.0	μs	
t_r	Rise time			1.3	4.0	μs	
$t_{d(off)}$	Turn-off delay time			1.8	5.5	μs	
t_f	Fall time			1.2	4.0	μs	
$(di/dt)_{on}$	Turn-on current slope	$V_{DD}=15\text{ V}$; $I_D=1.5\text{ A}$ $V_{gen}=5\text{ V}$; $R_{gen}=R_{IN\text{ MIN}}=330\ \Omega$		5		$\text{A}/\mu\text{s}$	
Q_i	Total input charge	$V_{DD}=12\text{ V}$; $I_D=0.5\text{ A}$; $V_{IN}=5\text{ V}$ $I_{gen}=2.13\text{ mA}$ (see Figure 7)		5		nC	
Source drain diode ($T_j=25\text{ }^\circ\text{C}$, unless otherwise specified)							
$V_{SD}^{(1)}$	Forward on voltage	$I_{SD}=0.5\text{ A}$; $V_{IN}=0\text{ V}$		0.8		V	
t_{rr}	Reverse recovery time	$I_{SD}=0.5\text{ A}$; $di/dt=6\text{ A}/\mu\text{s}$ $V_{DD}=30\text{ V}$; $L=200\ \mu\text{H}$ (see Figure 5)		205		ns	
Q_{rr}	Reverse recovery charge				100		nC
I_{RRM}	Reverse recovery current				0.7		A
Protections ($-40\text{ }^\circ\text{C}<T_j<150\text{ }^\circ\text{C}$, unless otherwise specified)							
I_{lim}	Drain current limit	$V_{IN}=5\text{ V}$; $V_{DS}=13\text{ V}$	1.7		3.5	A	
t_{dlim}	Step response current limit	$V_{IN}=5\text{ V}$; $V_{DS}=13\text{ V}$		2.0		μs	
T_{jsh}	Over temperature shutdown		150	175	200	$^\circ\text{C}$	
T_{jrs}	Over temperature reset		135			$^\circ\text{C}$	
I_{gf}	Fault sink current	$V_{IN}=5\text{ V}$; $V_{DS}=13\text{ V}$; $T_j=T_{jsh}$	10	15	20	mA	
E_{as}	Single pulse avalanche energy	Starting $T_j=25\text{ }^\circ\text{C}$; $V_{DD}=24\text{ V}$ $V_{IN}=5\text{ V}$ $R_{gen}=R_{IN\text{ MIN}}=330\ \Omega$; $L=50\text{ mH}$ (see Figure 6 and Figure 8)	55			mJ	

1. Pulsed: pulse duration = 300 μs , duty cycle 1.5 %

Figure 4. Switching time test circuit for resistive load

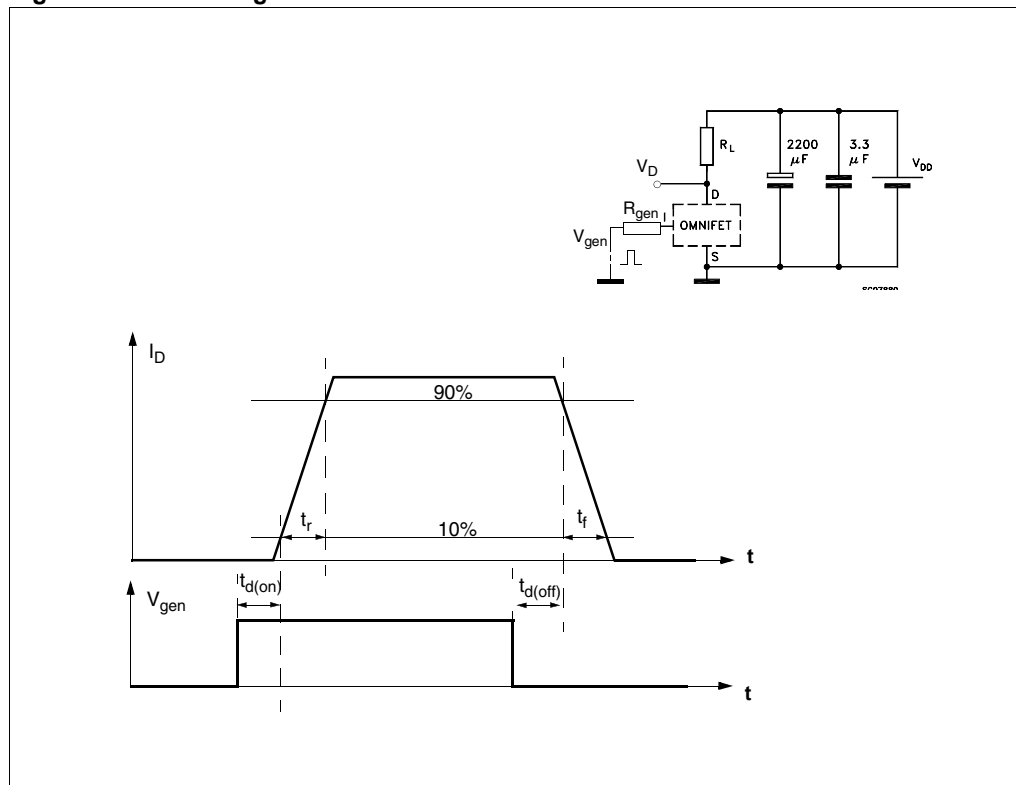

Figure 5. Test circuit for diode recovery times

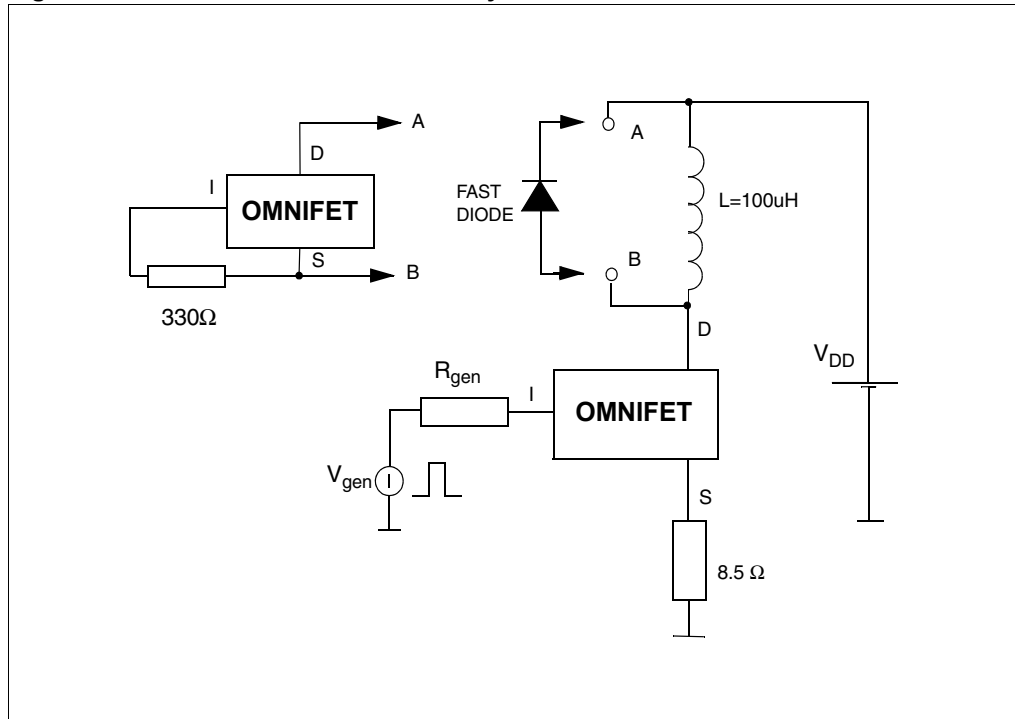

Figure 6. Unclamped inductive load test circuits

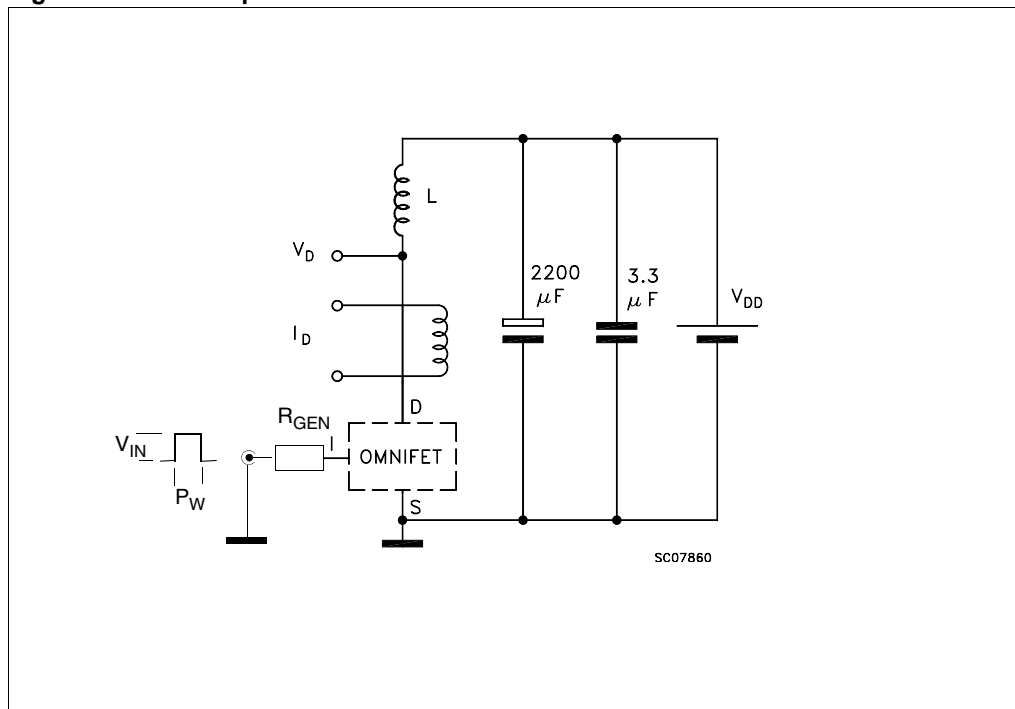

Figure 7. Input charge test circuit

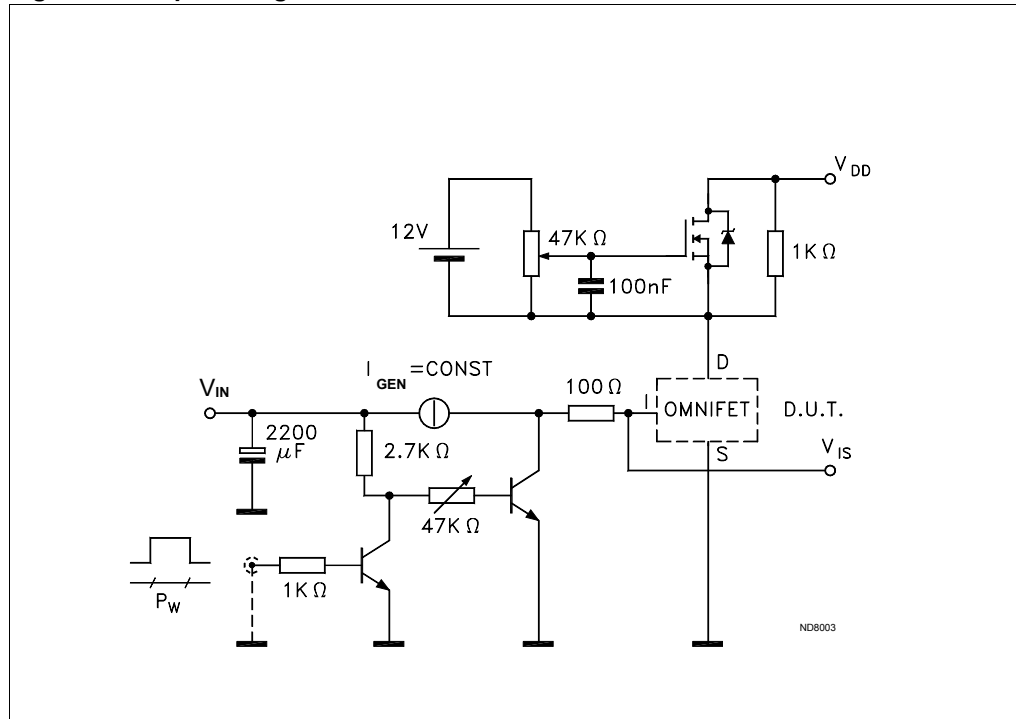
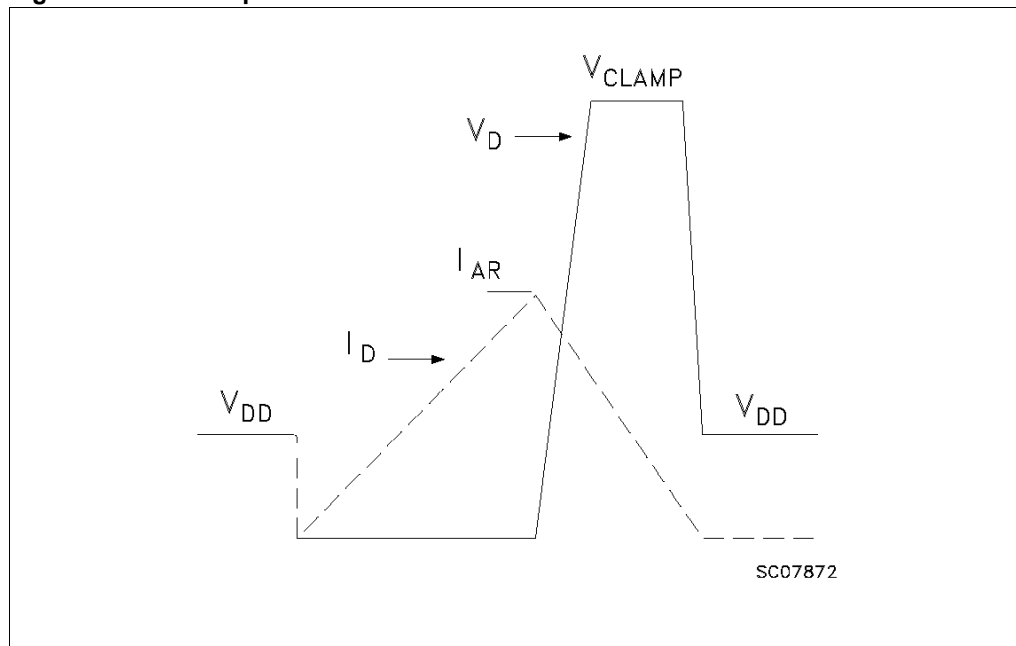

Figure 8. Unclamped inductive waveforms



2.4 Electrical characteristics curves

Figure 9. Source-drain diode forward characteristics

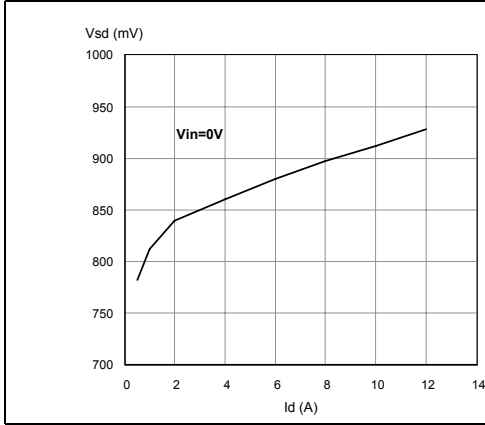

Figure 10. Static drain-source on resistance

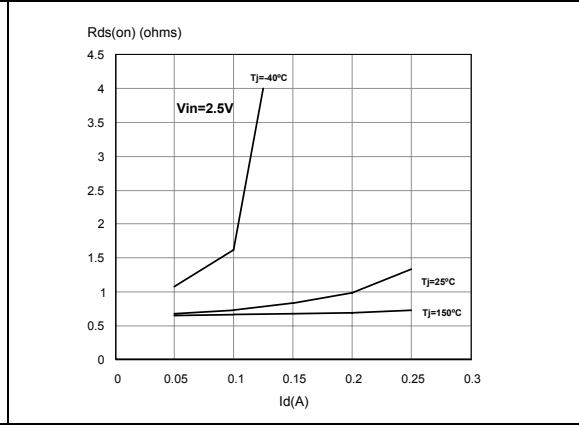

Figure 11. Derating curve

Figure 12. Static drain-source on resistance vs input voltage (part 1/2)

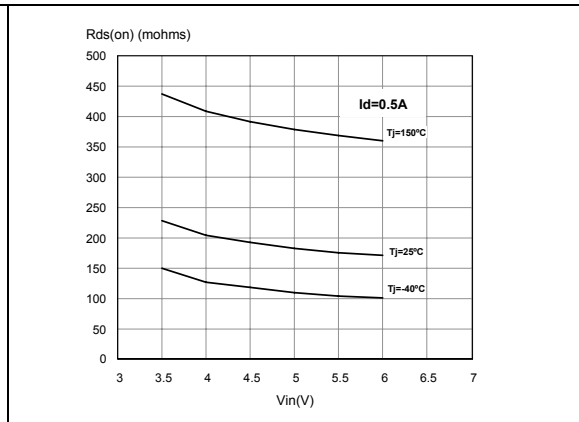
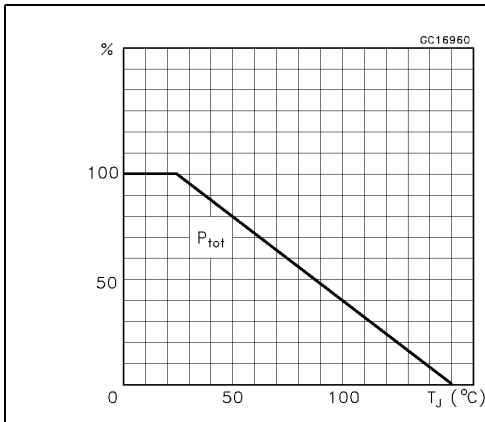

Figure 13. Static drain-source on resistance vs input voltage (part 2/2)

Figure 14. Transconductance

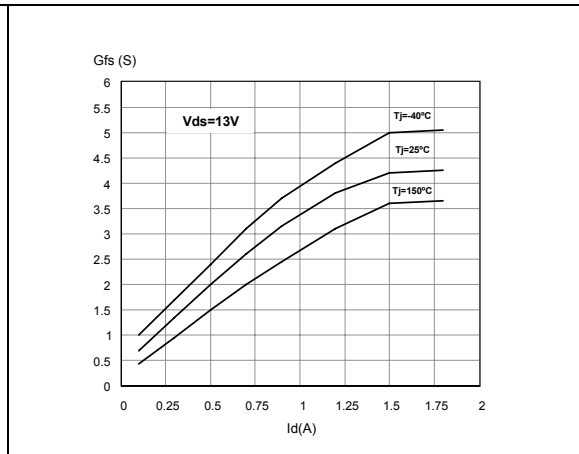
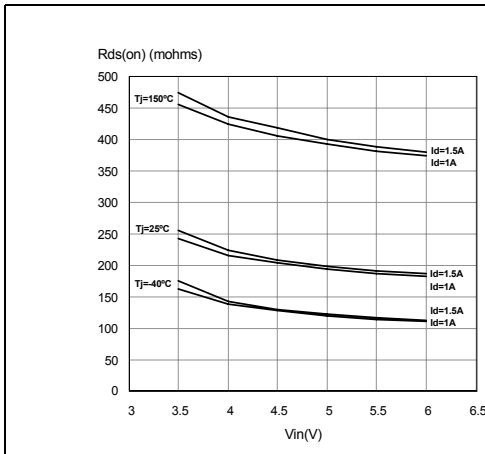

Figure 15. Static drain-source on resistance vs Id

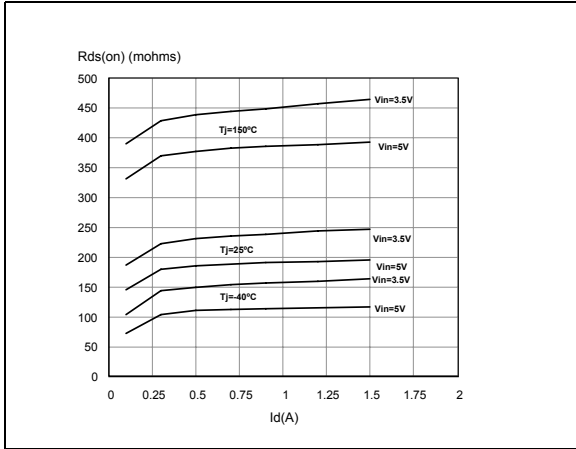

Figure 16. Transfer characteristics

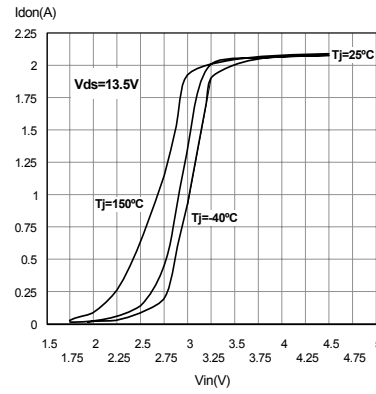

Figure 17. Turn-on current slope (part 1/2)

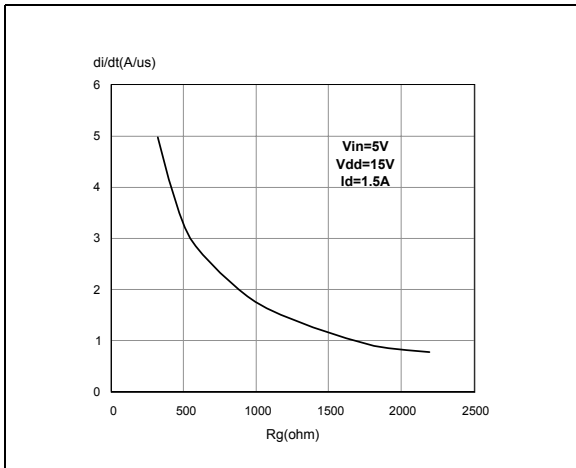

Figure 18. Turn-on current slope (part 2/2)

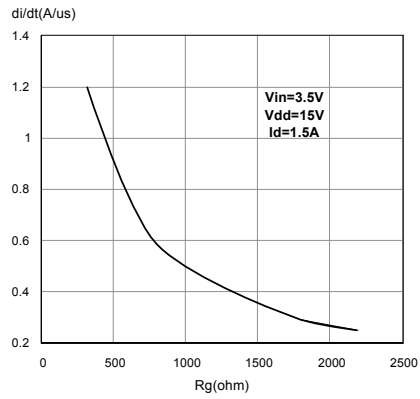

Figure 19. Input voltage vs input charge

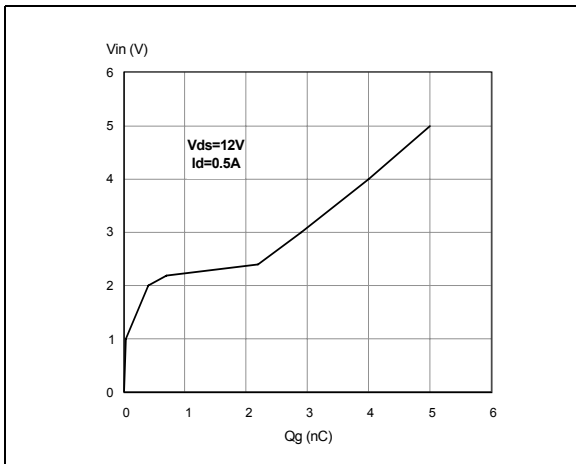

Figure 20. Turn-off drain source voltage slope (part 1/2)

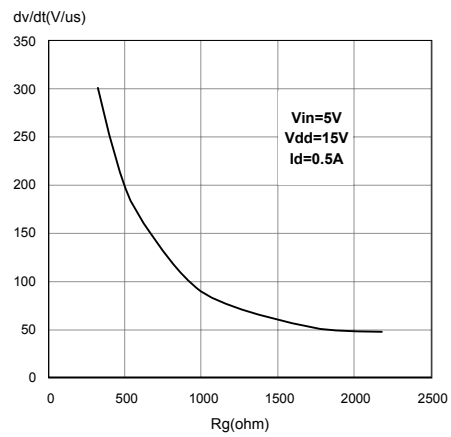

Figure 21. Turn-off drain-source voltage slope Figure 22. Capacitance variations (part 2/2)

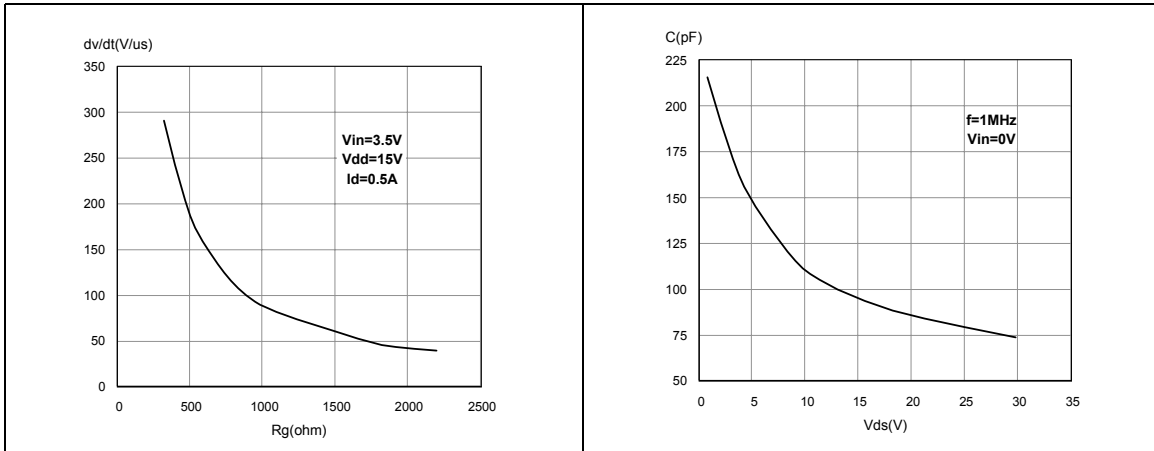

Figure 23. Switching time resistive load (part 1/2)

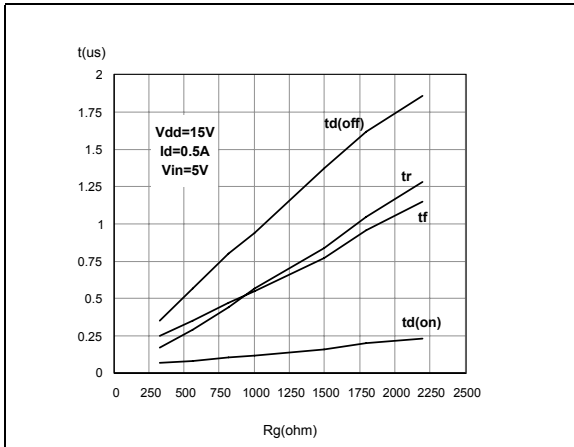

Figure 24. Switching time resistive load (part 2/2)

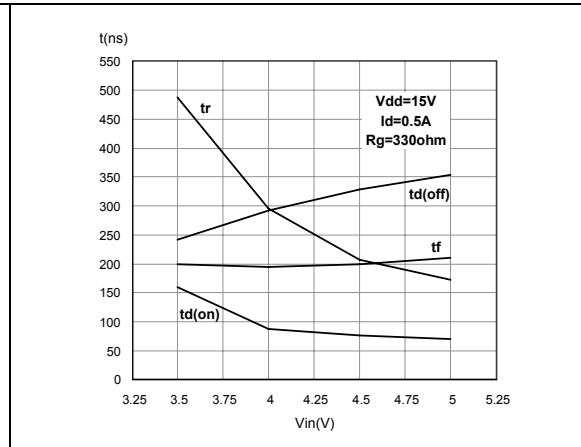

Figure 25. Output characteristics

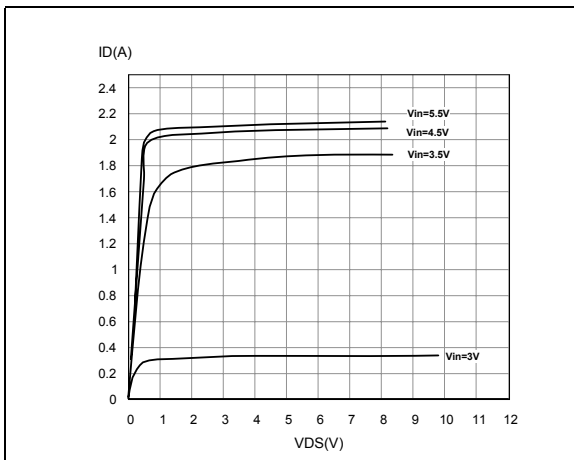

Figure 26. Normalized on resistance vs temperature

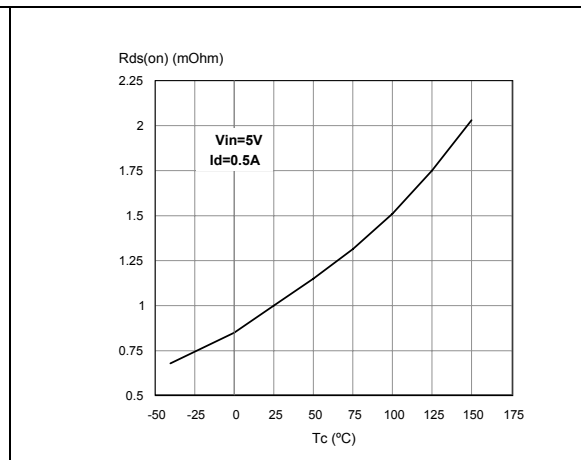

Figure 27. Normalized input threshold voltage vs temperature **Figure 28. Normalized current limit vs junction temperature**

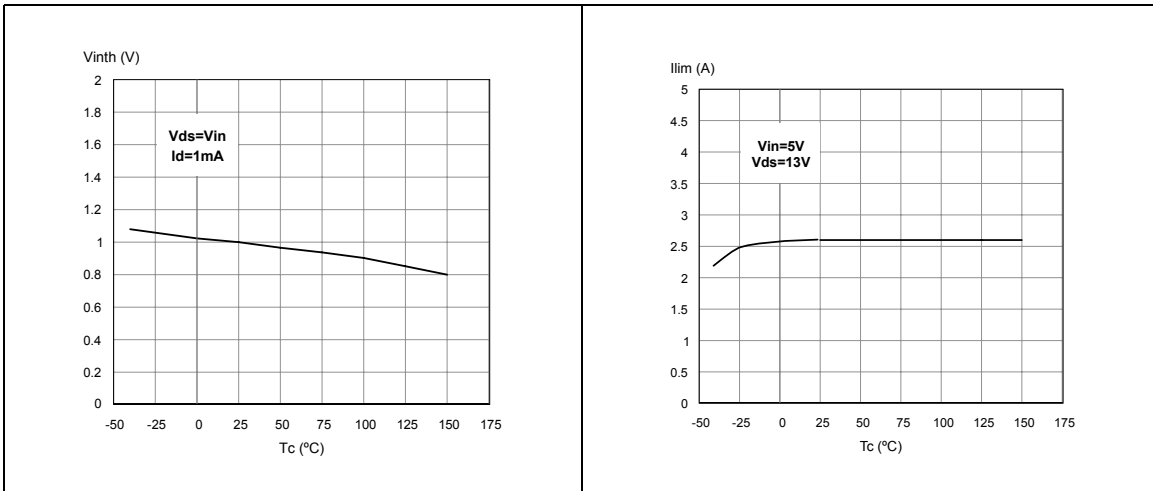
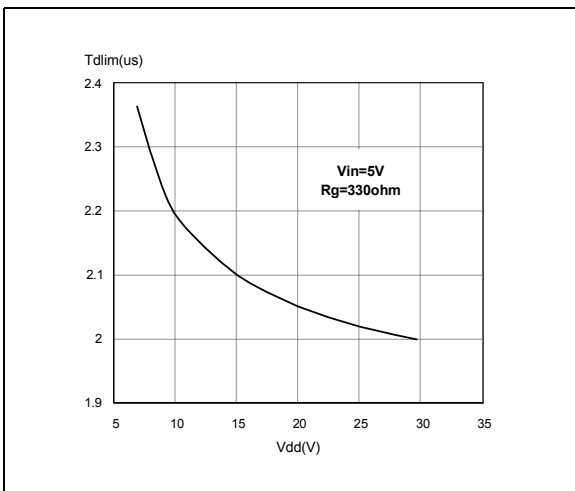

Figure 29. Step response current limit



3 Protection features

During normal operation, the input pin is electrically connected to the gate of the internal Power MOSFET through a low impedance path.

The device then behaves like a standard Power MOSFET and can be used as a switch from DC up to 50 kHz. The only difference from the user's standpoint is that a small DC current I_{ISS} (typ. 100 μ A) flows into the input pin in order to supply the internal circuitry.

The device integrates:

- Overvoltage clamp protection: internally set at 45 V, along with the rugged avalanche characteristics of the Power MOSFET stage give this device unrivalled ruggedness and energy handling capability. This feature is mainly important when driving inductive loads.
- Linear current limiter circuit: limits the drain current I_D to I_{lim} whatever the input pin voltages. When the current limiter is active, the device operates in the linear region, so power dissipation may exceed the capability of the heatsink. Both case and junction temperatures increase, and if this phase lasts long enough, junction temperature may reach the over temperature threshold T_{jsh} .
- Over temperature and short circuit protection: these are based on sensing the chip temperature and are not dependent on the input voltage. The location of the sensing element on the chip in the power stage area ensures fast, accurate detection of the junction temperature. Over temperature cutout occurs in the range 150 to 190 °C, a typical value being 170 °C. The device is automatically restarted when the chip temperature falls of about 15 °C below shutdown temperature.
- Status feedback: in the case of an over temperature fault condition ($T_j > T_{jsh}$), the device tries to sink a diagnostic current I_{gf} through the input pin in order to indicate fault condition. If driven from a low impedance source, this current may be used in order to warn the control circuit of a device shutdown. If the drive impedance is high enough so that the input pin driver is not able to supply the current I_{gf} , the input pin will fall to 0 V. This will not however affect the device operation: no requirement is put on the current capability of the input pin driver except to be able to supply the normal operation drive current I_{ISS} .

Additional features of this device are ESD protection according to the Human Body model and the ability to be driven from a TTL logic circuit.

4 Package and PCB thermal data

4.1 SOT-223 thermal data

Figure 30. SOT-223 PC board

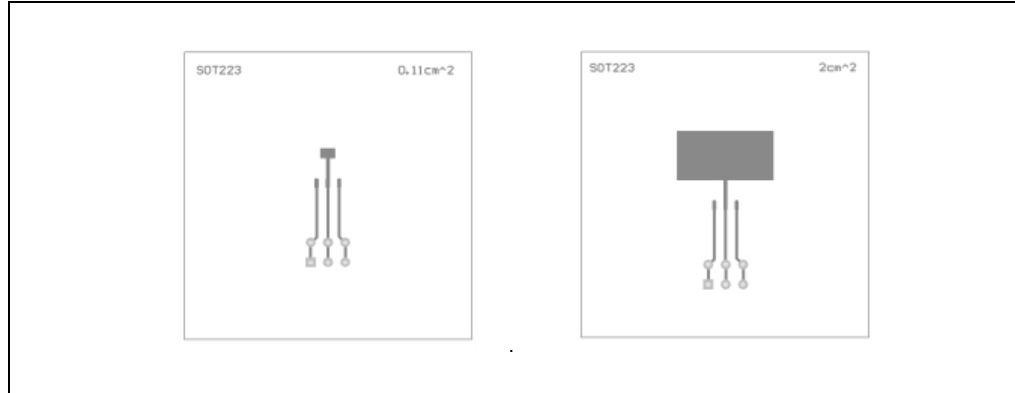

Note: Layout condition of R_{th} and Z_{th} measurements (PCB FR4 area = 58 mm x 58 mm, PCB thickness = 2 mm, Cu thickness = 35 μ m, Copper areas: from minimum pad layout to 0.8 cm²).

Figure 31. SOT-223 $R_{thj-amb}$ vs PCB copper area in open box free air condition

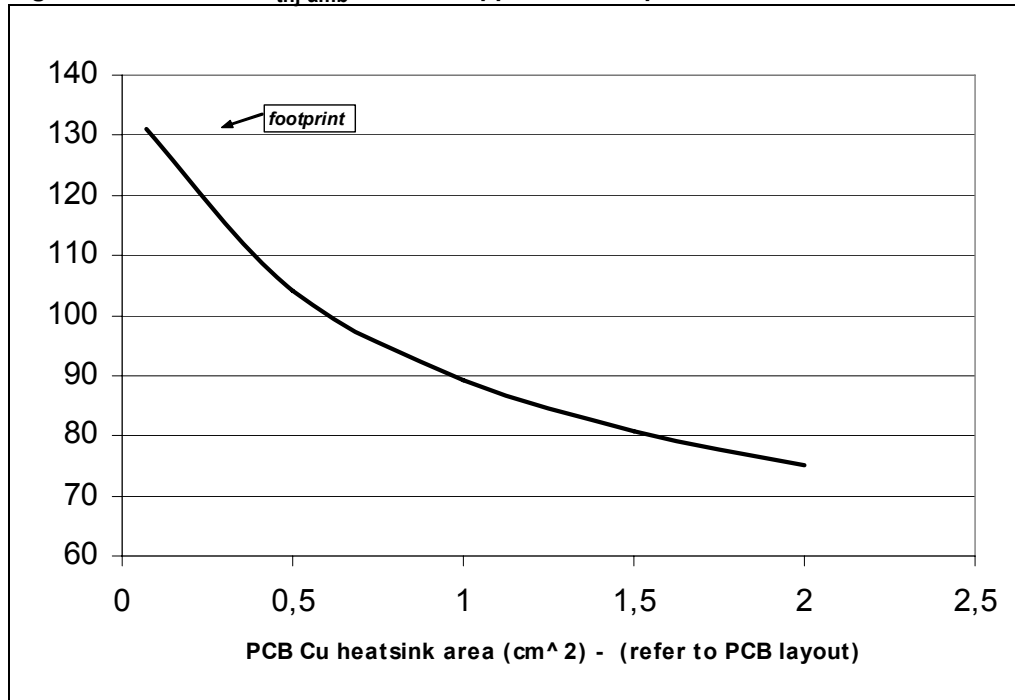
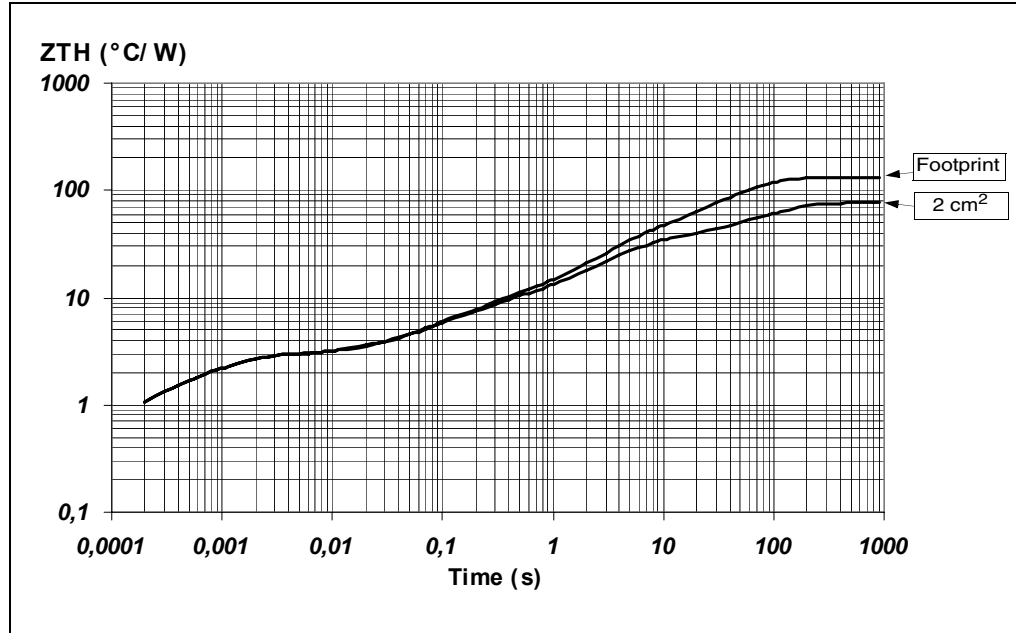

Figure 32. SOT-223 thermal impedance junction ambient single pulse



Equation 1: pulse calculation formula

$$Z_{TH\delta} = R_{TH} \cdot \delta + Z_{THtp}(1 - \delta)$$

where $\delta = t_p/T$

Figure 33. SOT-223 thermal fitting model of a single channel

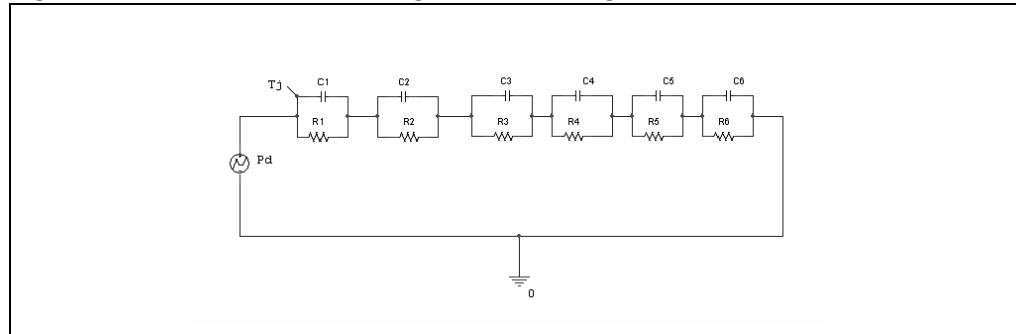

Table 5. SOT-223 thermal parameter

Area/island (cm ²)	FP	2
R1 (°C/W)	0.8	
R2 (°C/W)	1.6	
R3 (°C/W)	4.5	
R4 (°C/W)	24	
R5 (°C/W)	0.1	
R6 (°C/W)	100	45

Table 5. SOT-223 thermal parameter (continued)

Area/island (cm ²)	FP	2
C1 (W·s/°C)	0.00006	
C2 (W·s/°C)	0.0005	
C3 (W·s/°C)	0.03	
C4 (W·s/°C)	0.16	
C5 (W·s/°C)	1000	
C6 (W·s/°C)	0.5	2

4.2 SO-8 thermal data

Figure 34. SO-8 PC board

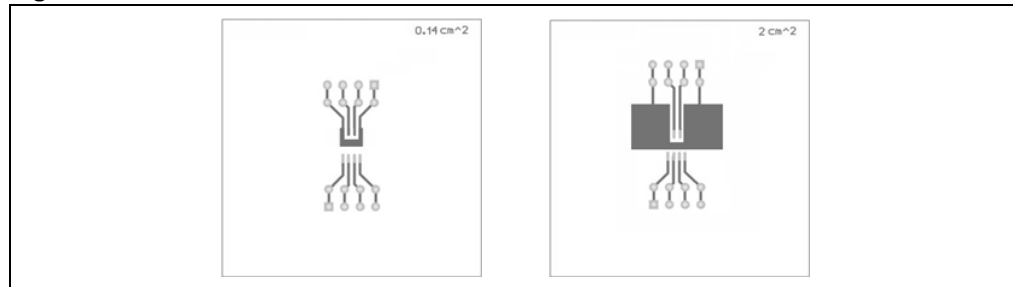

Note: Layout condition of R_{th} and Z_{th} measurements (PCB FR4 area = 58 mm x 58 mm, PCB thickness = 2 mm, Cu thickness = 35 μm, Copper areas: from minimum pad layout to 2 cm²).

Figure 35. SO-8 $R_{thj-amb}$ vs PCB copper area in open box free air condition

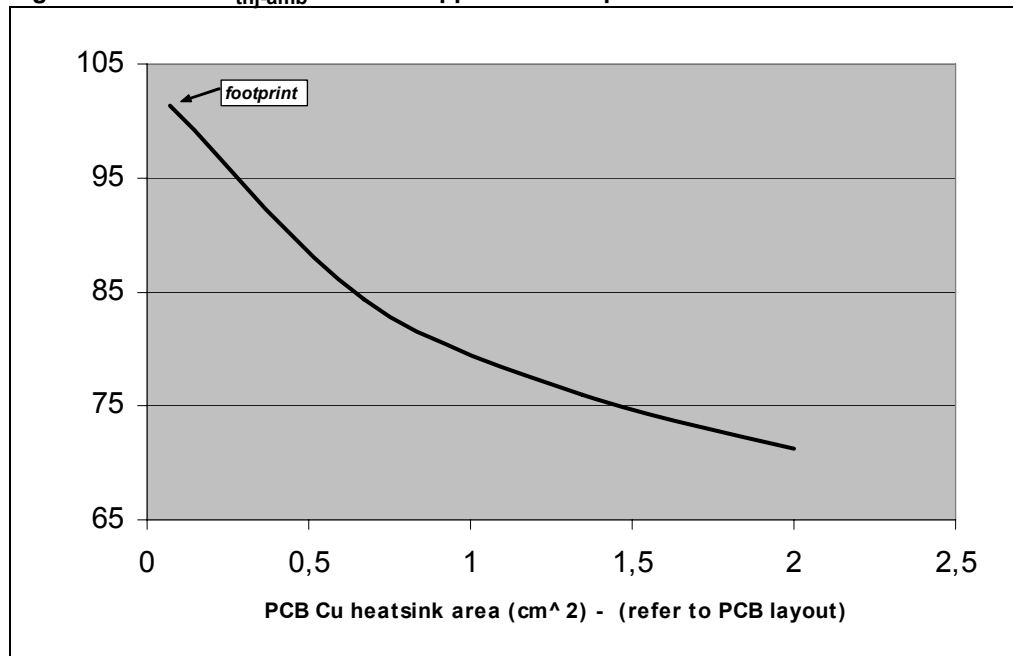
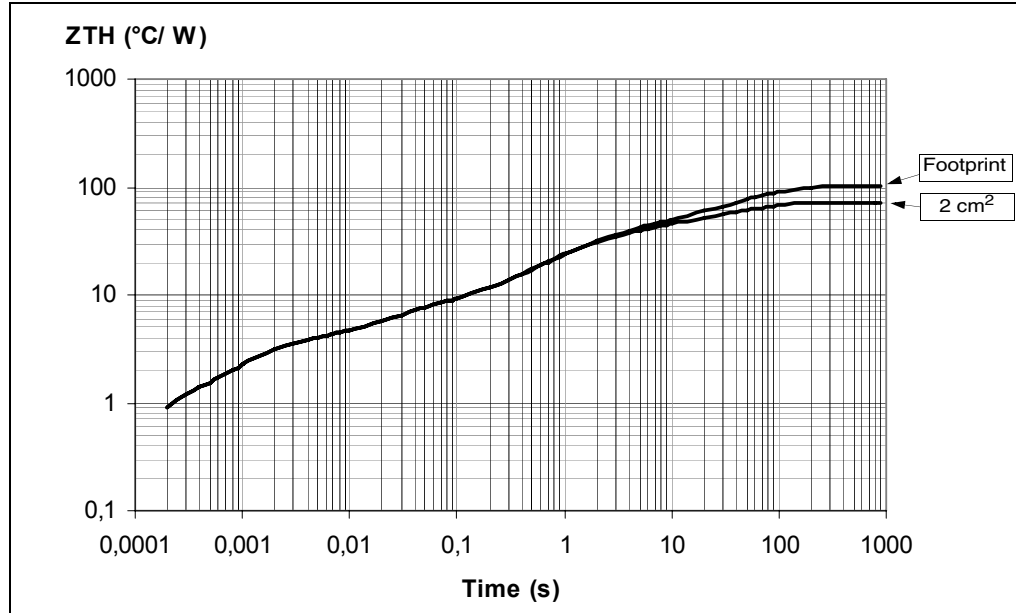

Figure 36. SO-8 thermal impedance junction ambient single pulse



Equation 2: pulse calculation formula

$$Z_{TH\delta} = R_{TH} \cdot \delta + Z_{THtp}(1 - \delta)$$

where $\delta = t_p/T$

Figure 37. SO-8 thermal fitting model of a single channel

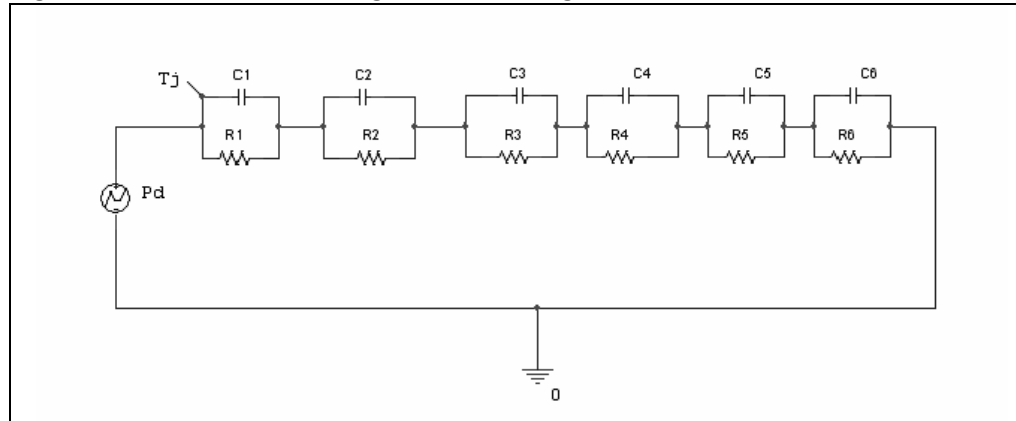

Table 6. SO-8 thermal parameter

Area/island (cm ²)	FP	2
R1 (°C/W)	0.8	
R2 (°C/W)	2.6	
R3 (°C/W)	3.5	
R4 (°C/W)	21	

Table 6. SO-8 thermal parameter (continued)

Area/island (cm ²)	FP	2
R5 (°C/W)	16	
R6 (°C/W)	58	28
C1 (W·s/°C)	0.00006	
C2 (W·s/°C)	0.0005	
C3 (W·s/°C)	0.0075	
C4 (W·s/°C)	0.045	
C5 (W·s/°C)	0.35	
C6 (W·s/°C)	1.05	2

5 Package and packing information

In order to meet environmental requirements, ST offers these devices in different grades of ECOPACK[®] packages, depending on their level of environmental compliance. ECOPACK[®] specifications, grade definitions and product status are available at: www.st.com.

ECOPACK[®] is an ST trademark.

5.1 SOT-223 mechanical data

Figure 38. SOT-223 mechanical data and package outline

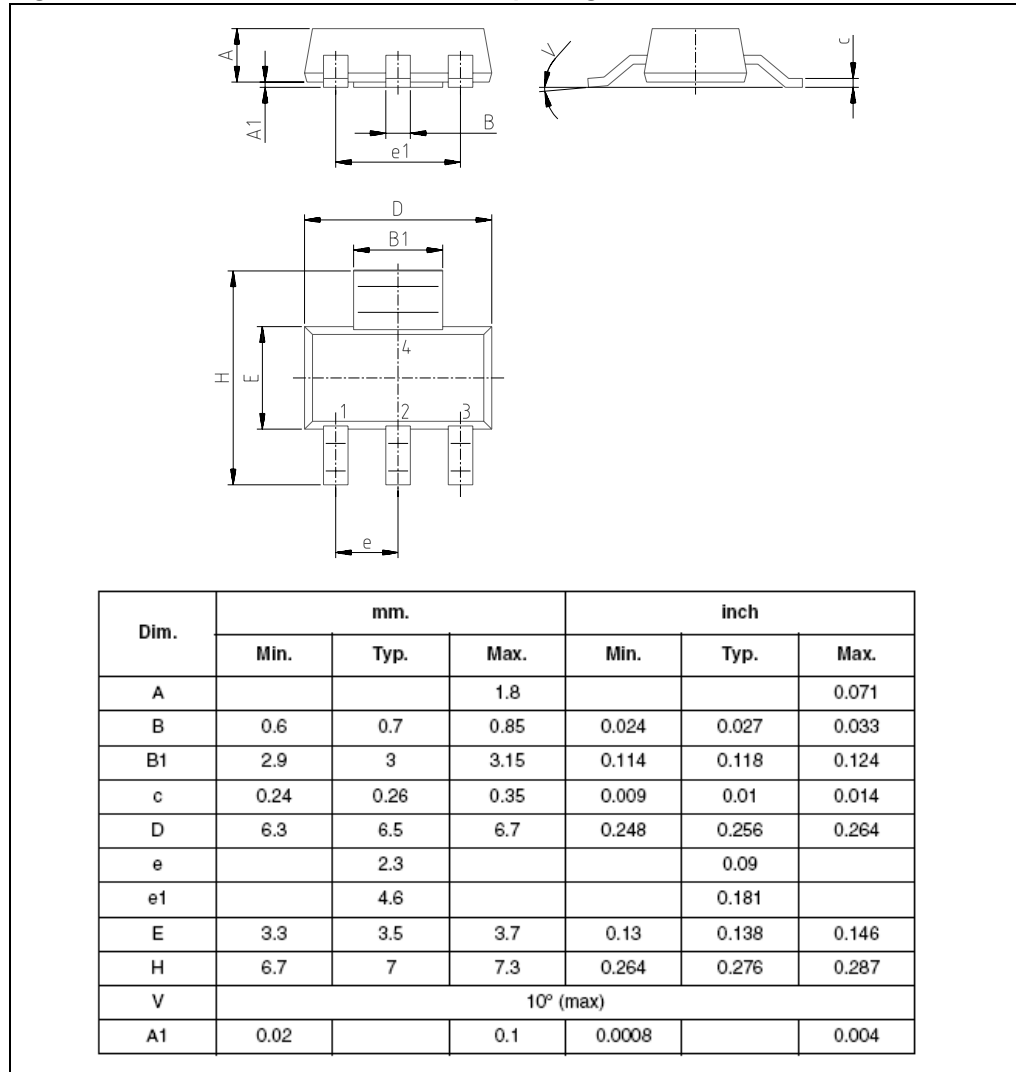

5.2 SO8 mechanical data

Table 7. SO-8 mechanical data

Dim.	mm		
	Min.	Typ.	Max.
A			1.75
A1	0.10		0.25
A2	1.25		
b	0.28		0.48
c	0.17		0.23
D ⁽¹⁾	4.80	4.90	5.00
E	5.80	6.00	6.20
E1 ⁽²⁾	3.80	3.90	4.00
e		1.27	
h	0.25		0.50
L	0.40		1.27
L1		1.04	
k	0°		8°
ccc			0.10

1. Dimension "D" does not include mold flash, protrusions or gate burrs. Mold flash, protrusions or gate burrs shall not exceed 0.15 mm in total (both side).
2. Dimension "E1" does not include interlead flash or protrusions. Interlead flash or protrusions shall not exceed 0.25 mm per side.

Figure 39. SO-8 package dimension

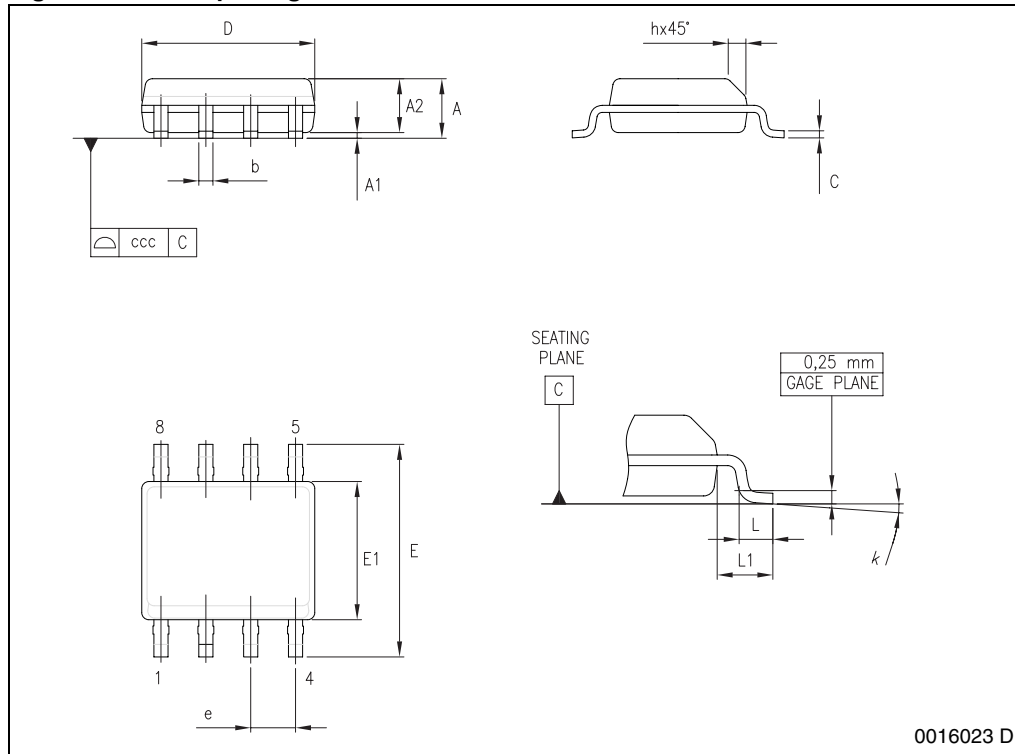

5.3 SOT-223 packing information

Figure 40. SOT-223 tape and reel shipment (suffix “TR”)

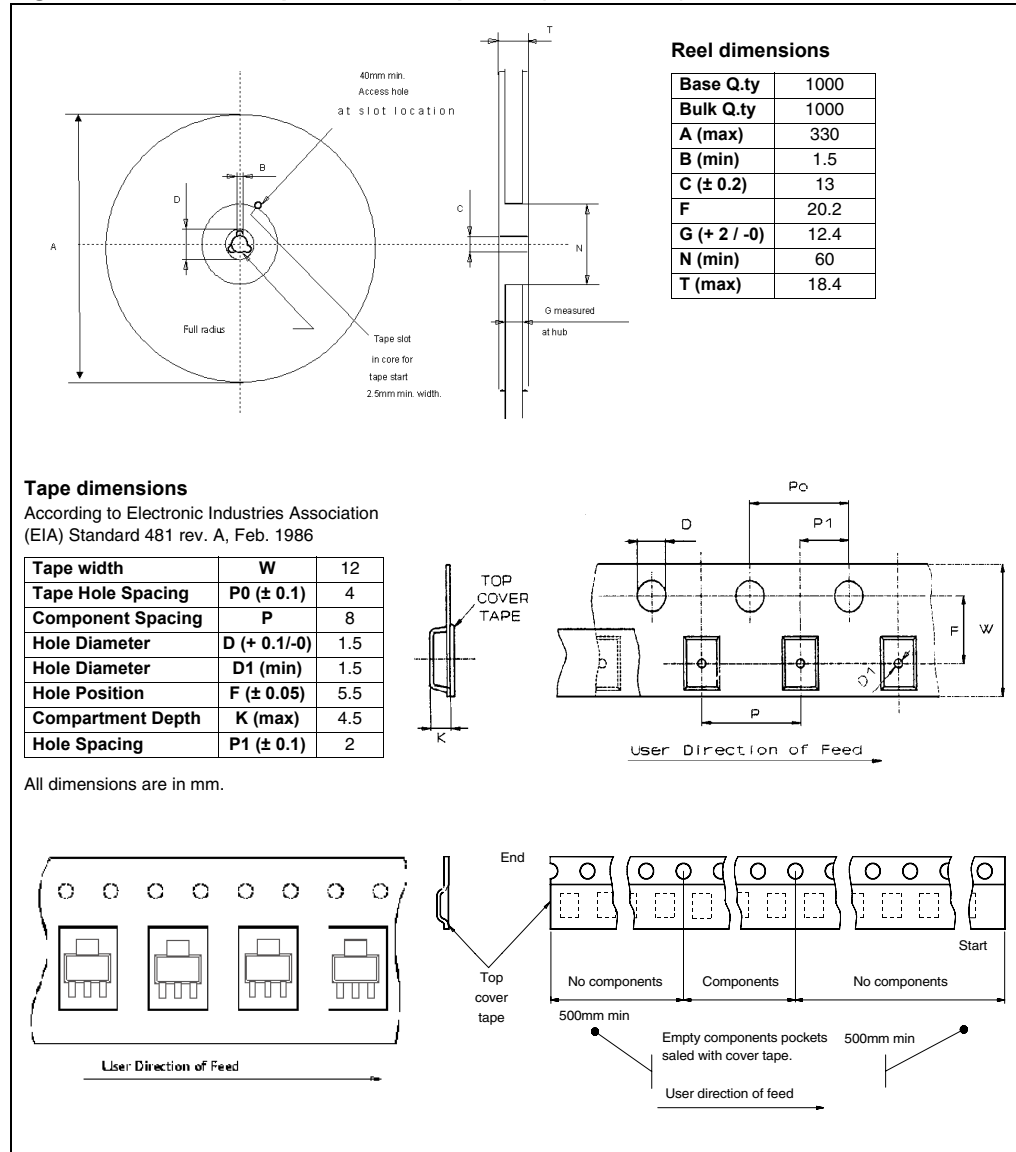

5.4 SO8 packing information

Figure 41. SO-8 tube shipment (no suffix)

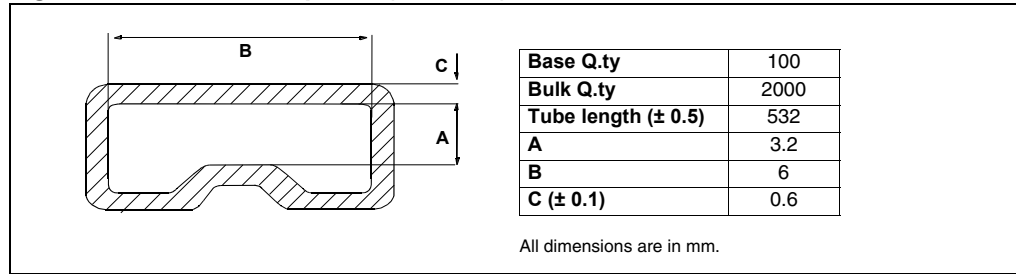
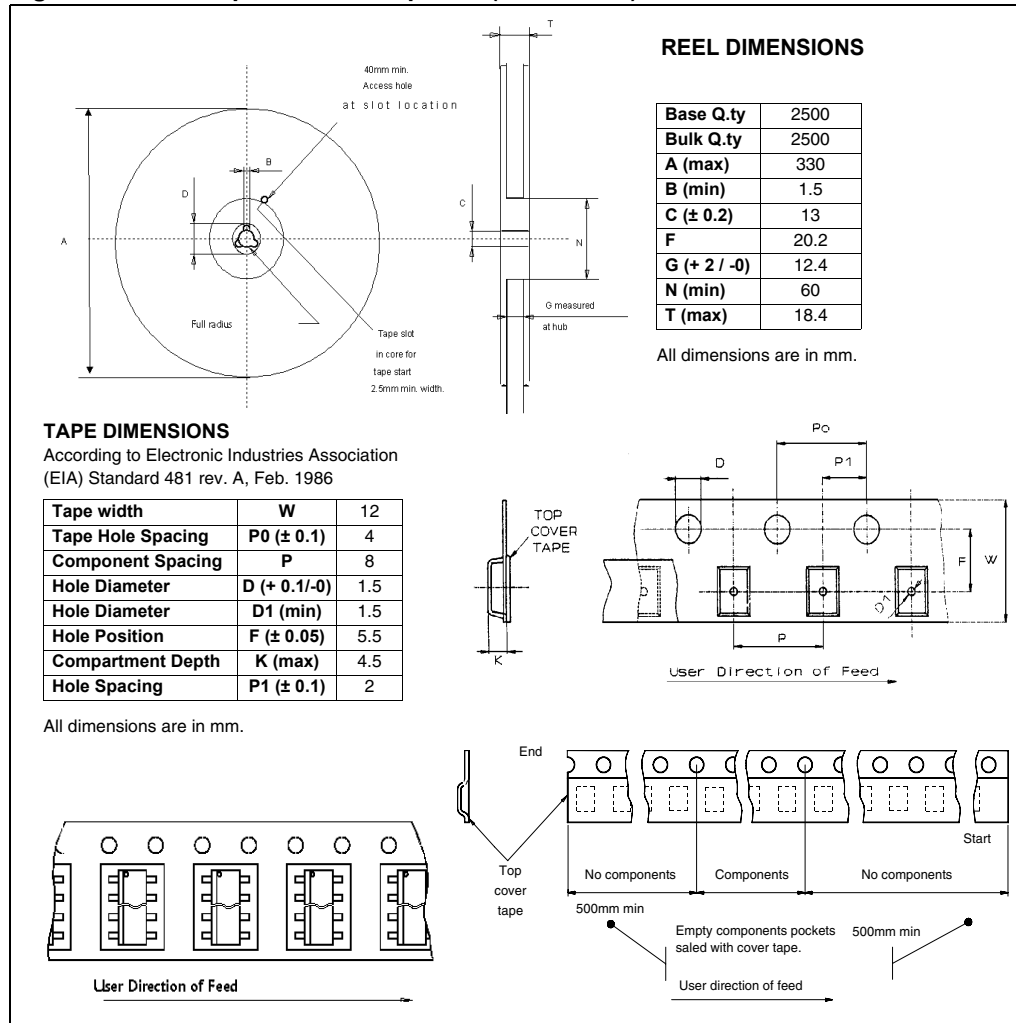

Figure 42. SO-8 tape and reel shipment (suffix “TR”)



6 Revision history

Table 8. Document revision history

Date	Revision	Changes
16-May-2009	1	Initial release.
29-Sep-2009	2	Removed target specification on cover page.

Please Read Carefully:

Information in this document is provided solely in connection with ST products. STMicroelectronics NV and its subsidiaries ("ST") reserve the right to make changes, corrections, modifications or improvements, to this document, and the products and services described herein at any time, without notice.

All ST products are sold pursuant to ST's terms and conditions of sale.

Purchasers are solely responsible for the choice, selection and use of the ST products and services described herein, and ST assumes no liability whatsoever relating to the choice, selection or use of the ST products and services described herein.

No license, express or implied, by estoppel or otherwise, to any intellectual property rights is granted under this document. If any part of this document refers to any third party products or services it shall not be deemed a license grant by ST for the use of such third party products or services, or any intellectual property contained therein or considered as a warranty covering the use in any manner whatsoever of such third party products or services or any intellectual property contained therein.

UNLESS OTHERWISE SET FORTH IN ST'S TERMS AND CONDITIONS OF SALE ST DISCLAIMS ANY EXPRESS OR IMPLIED WARRANTY WITH RESPECT TO THE USE AND/OR SALE OF ST PRODUCTS INCLUDING WITHOUT LIMITATION IMPLIED WARRANTIES OF MERCHANTABILITY, FITNESS FOR A PARTICULAR PURPOSE (AND THEIR EQUIVALENTS UNDER THE LAWS OF ANY JURISDICTION), OR INFRINGEMENT OF ANY PATENT, COPYRIGHT OR OTHER INTELLECTUAL PROPERTY RIGHT.

UNLESS EXPRESSLY APPROVED IN WRITING BY AN AUTHORIZED ST REPRESENTATIVE, ST PRODUCTS ARE NOT RECOMMENDED, AUTHORIZED OR WARRANTED FOR USE IN MILITARY, AIR CRAFT, SPACE, LIFE SAVING, OR LIFE SUSTAINING APPLICATIONS, NOR IN PRODUCTS OR SYSTEMS WHERE FAILURE OR MALFUNCTION MAY RESULT IN PERSONAL INJURY, DEATH, OR SEVERE PROPERTY OR ENVIRONMENTAL DAMAGE. ST PRODUCTS WHICH ARE NOT SPECIFIED AS "AUTOMOTIVE GRADE" MAY ONLY BE USED IN AUTOMOTIVE APPLICATIONS AT USER'S OWN RISK.

Resale of ST products with provisions different from the statements and/or technical features set forth in this document shall immediately void any warranty granted by ST for the ST product or service described herein and shall not create or extend in any manner whatsoever, any liability of ST.

ST and the ST logo are trademarks or registered trademarks of ST in various countries.

Information in this document supersedes and replaces all information previously supplied.

The ST logo is a registered trademark of STMicroelectronics. All other names are the property of their respective owners.

© 2009 STMicroelectronics - All rights reserved

STMicroelectronics group of companies

Australia - Belgium - Brazil - Canada - China - Czech Republic - Finland - France - Germany - Hong Kong - India - Israel - Italy - Japan - Malaysia - Malta - Morocco - Philippines - Singapore - Spain - Sweden - Switzerland - United Kingdom - United States of America

www.st.com