

Power Management Switch ICs for PCs and Digital Consumer Products

1ch High Current Output USB High Side Switch ICs



BD2061AFJ, BD2065AFJ

No.11029EBT06

●Description

Single channel high side switch IC for USB port is a high side switch having over current protection used in power supply line of universal serial bus (USB). N-channel power MOSFET of low on resistance and low supply current are realized in this IC. And, over current detection circuit, thermal shutdown circuit, under voltage lockout and soft start circuit are built in.

●Features

- 1) Low on resistance 80mΩ Nch MOSFET Switch.
- 2) Continuous current load 1.0A
- 3) Control input logic
Active-Low : BD2061AFJ
Active-High : BD2065AFJ
- 4) Soft start circuit
- 5) Over current detection
- 6) Thermal shutdown
- 7) Under voltage lockout
- 8) Open drain error flag output
- 9) Reverse-current protection when power switch off
- 10) Power supply voltage range 2.7V~5.5V
- 11) TTL Enable input
- 12) 1.2ms typical rise time
- 13) 10μA max standby current
- 14) Operating temperature range -40°C~85°C

●Applications

USB hub in consumer appliances, Car accessory, PC, PC peripheral equipment, and so forth

●Lineup

Parameter	BD2061AFJ	BD2065AFJ
Continuous current load (A)	1.0	1.0
Output current at short (A)	1.5	1.5
Control input logic	Low	High

●Absolute Maximum Ratings

Parameter	Symbol	Ratings	Unit
Supply voltage	V _{IN}	-0.3 to 6.0	V
Enable voltage	V _{EN} , V _{EN}	-0.3 to 6.0	V
/OC voltage	V _{IOC}	-0.3 to 6.0	V
/OC current	I _{SIOC}	10	mA
OUT voltage	V _{OUT}	-0.3 to 6.0	V
Storage temperature	T _{STG}	-55 to 150	°C
Power dissipation	PD	560 ^{*1}	mW

*1 In the case of exceeding Ta = 25°C, 4.48mW should be reduced per 1°C.

* This chip is not designed to protect itself against radioactive rays.

●Operating conditions

Parameter	Symbol	Ratings	Unit
Operating voltage	V _{IN}	2.7 to 5.5	V
Operating temperature	T _{OPR}	-40 to 85	°C
Continuous output current	I _{LO}	0 to 1.0	A

● Electrical characteristics

◎BD2061AFJ (Unless otherwise specified, $V_{IN} = 5.0V$, $T_a = 25^\circ C$)

Parameter	Symbol	Limits			Unit	Condition
		Min.	Typ.	Max.		
Operating Current	I_{DD}	-	90	120	μA	$V_{EN} = 0V$, $OUT = OPEN$
Standby Current	I_{STB}	-	0.01	1	μA	$V_{EN} = 5V$, $OUT = OPEN$
/EN input voltage	V_{EN}	2.0	-	-	V	High input
	V_{EN}	-	-	0.8	V	Low input
		-	-	0.4	V	Low input $2.7V \leq V_{IN} \leq 4.5V$
/EN input current	I_{EN}	-1.0	0.01	1.0	μA	$V_{EN} = 0V$ or $V_{EN} = 5V$
/OC output LOW voltage	V_{IOC}	-	-	0.5	V	$I_{OC} = 5mA$
/OC output leak current	I_{LIOC}	-	0.01	1	μA	$V_{IOC} = 5V$
/OC delay time	T_{DIOC}	-	2.5	8	ms	
ON resistance	R_{ON}	-	80	100	m Ω	$I_{OUT} = 1.0A$
Output current at short	I_{SC}	1.1	1.5	1.9	A	$V_{IN} = 5V$, $V_{OUT} = 0V$, $C_L = 100\mu F$ (RMS)
Output rise time	T_{ON1}	-	1.2	10	ms	$R_L = 10\Omega$, $C_L = OPEN$
Output turn on time	T_{ON2}	-	1.5	20	ms	
Output fall time	T_{OFF1}	-	1	20	μs	
Output turn off time	T_{OFF2}	-	3	40	μs	
UVLO threshold	V_{TUVH}	2.1	2.3	2.5	V	Increasing V_{IN}
	V_{TUVL}	2.0	2.2	2.4	V	Decreasing V_{IN}

◎BD2065AFJ (Unless otherwise specified, $V_{IN} = 5.0V$, $T_a = 25^\circ C$)

Parameter	Symbol	Limits			Unit	Condition
		Min.	Typ.	Max.		
Operating Current	I_{DD}	-	90	120	μA	$V_{EN} = 5V$, $OUT = OPEN$
Standby Current	I_{STB}	-	0.01	1	μA	$V_{EN} = 0V$, $OUT = OPEN$
EN input voltage	V_{EN}	2.0	-	-	V	High input
	V_{EN}	-	-	0.8	V	Low input
		-	-	0.4	V	Low input $2.7V \leq V_{IN} \leq 4.5V$
EN input current	I_{EN}	-1.0	0.01	1.0	μA	$V_{EN} = 0V$ or $V_{EN} = 5V$
/OC output LOW voltage	V_{IOC}	-	-	0.5	V	$I_{OC} = 5mA$
/OC output leak current	I_{LIOC}	-	0.01	1	μA	$V_{IOC} = 5V$
/OC delay time	T_{DIOC}	-	2.5	8	ms	
ON resistance	R_{ON}	-	80	100	m Ω	$I_{OUT} = 1.0A$
Output current at short	I_{SC}	1.1	1.5	1.9	A	$V_{IN} = 5V$, $V_{OUT} = 0V$, $C_L = 100\mu F$ (RMS)
Output rise time	T_{ON1}	-	1.2	10	ms	$R_L = 10\Omega$, $C_L = OPEN$
Output turn on time	T_{ON2}	-	1.5	20	ms	
Output fall time	T_{OFF1}	-	1	20	μs	
Output turn off time	T_{OFF2}	-	3	40	μs	
UVLO Threshold	V_{TUVH}	2.1	2.3	2.5	V	Increasing V_{IN}
	V_{TUVL}	2.0	2.2	2.4	V	Decreasing V_{IN}

● Measurement circuit

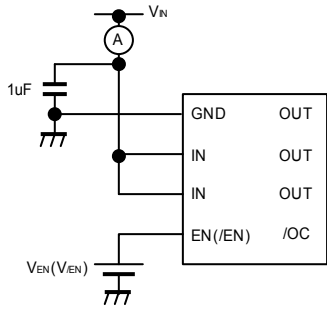

Operating current

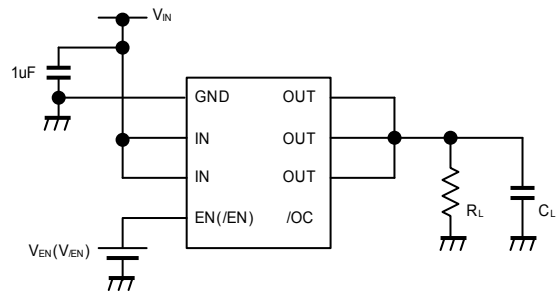

EN, /EN input voltage, Output rise, fall time

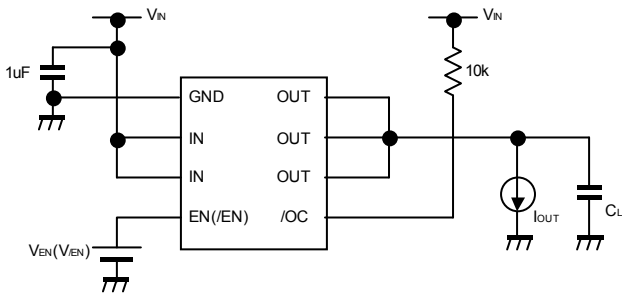

ON resistance, Over current detection

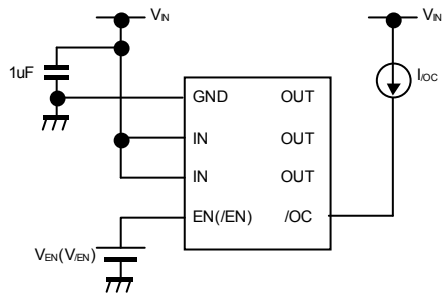

/OC output LOW voltage

Fig.1 Measurement circuit

● Timing diagram

OBD2061AFJ

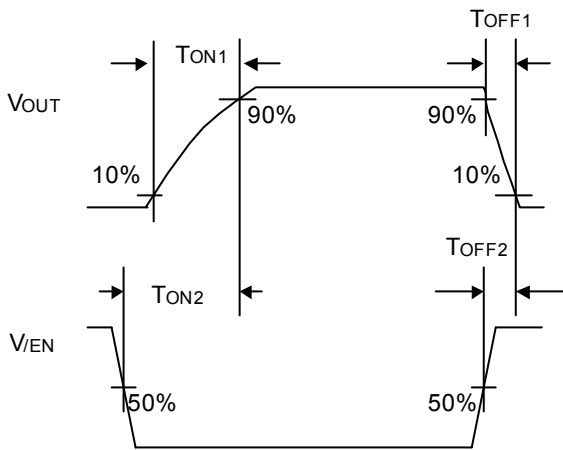

Fig.2 Timing diagram

OBD2065AFJ

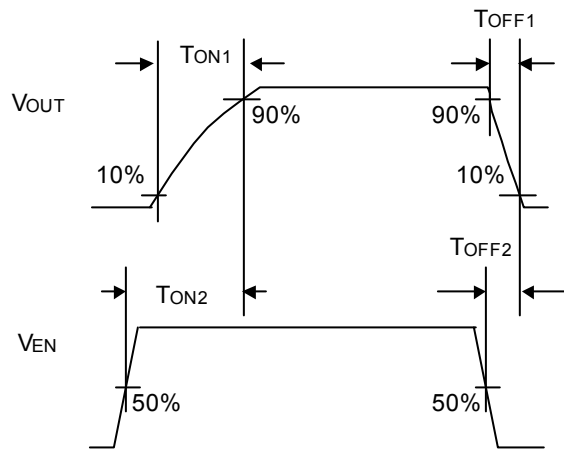

Fig.3 Timing diagram

●Reference data

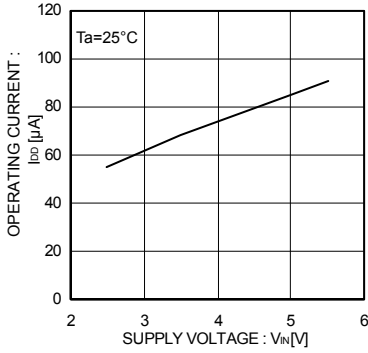

Fig.4 Operating current
EN, /EN Enable

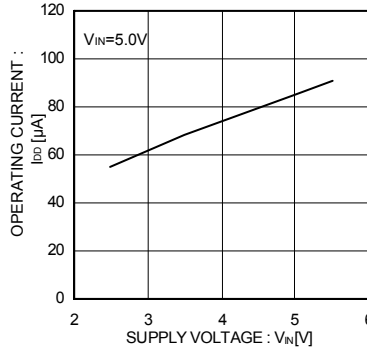

Fig.5 Operating current
EN, /EN Enable

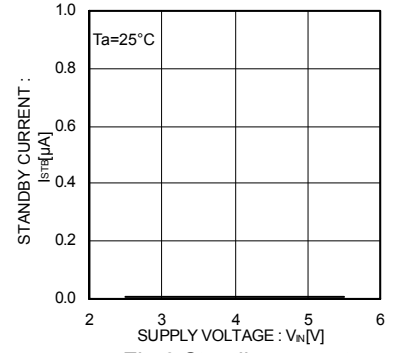

Fig.6 Standby current
EN, /EN Disable

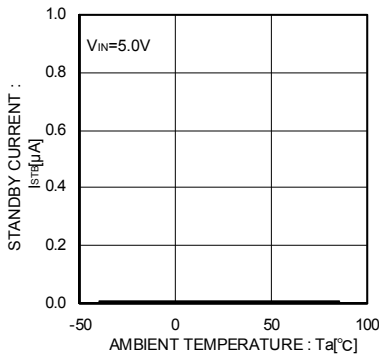

Fig.7 Standby current
EN, /EN Disable

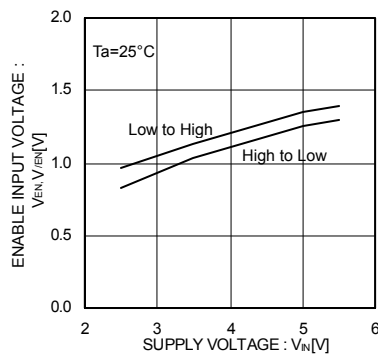

Fig.8 EN, /EN input voltage

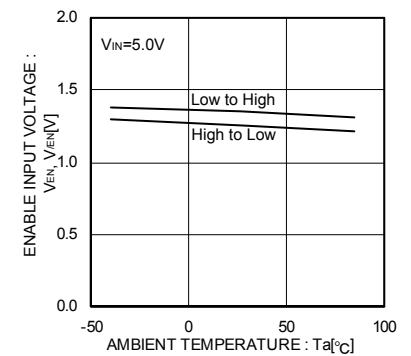

Fig.9 EN, /EN input voltage

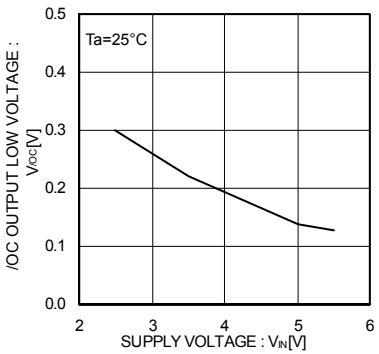

Fig.10 /OC output LOW voltage

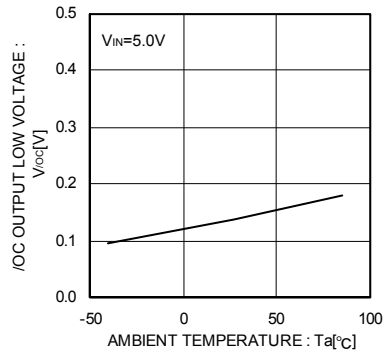

Fig.11 /OC output LOW voltage

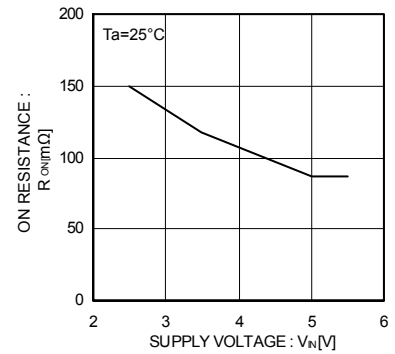

Fig.12 ON resistance

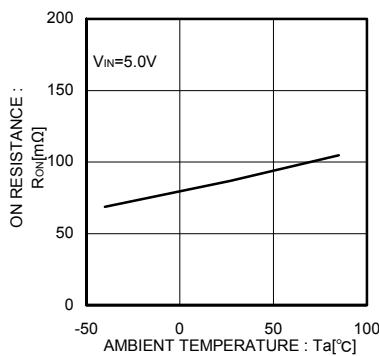

Fig.13 ON resistance

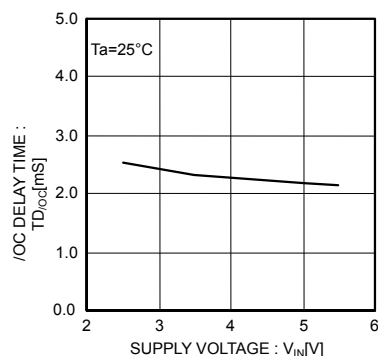

Fig.14 /OC output delay time

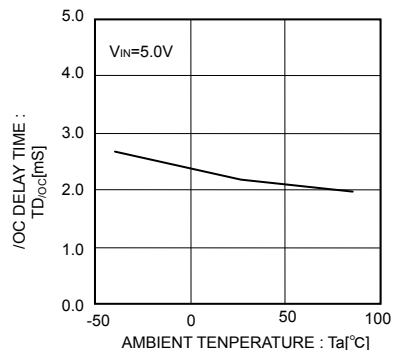

Fig.15 /OC output delay time

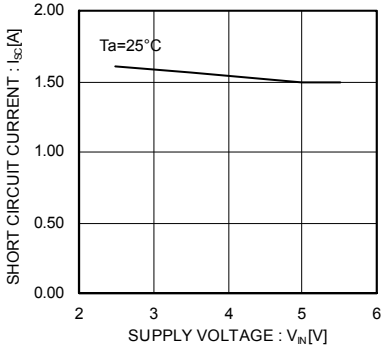

Fig.16 Output current at shortcircuit

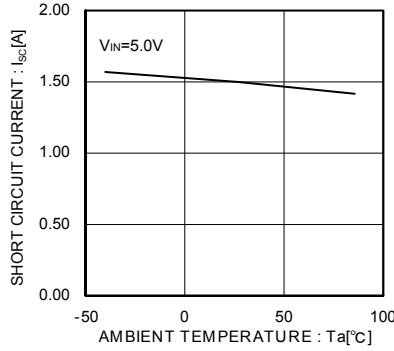

Fig.17 Output current at shortcircuit

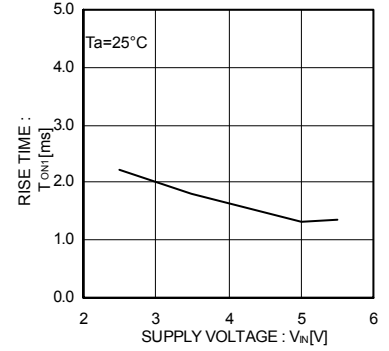

Fig.18 Output rise time

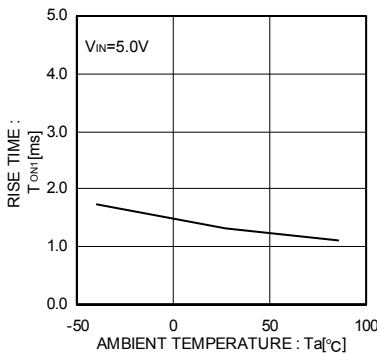

Fig.19 Output rise time

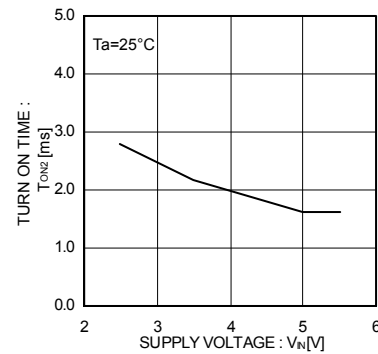

Fig.20 Output turn on time

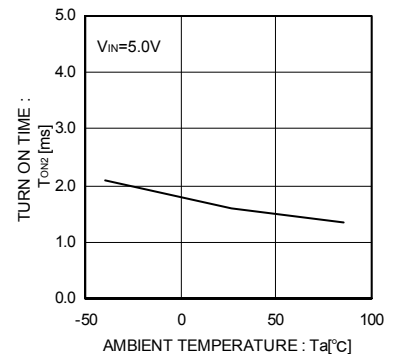

Fig.21 Output turn on time

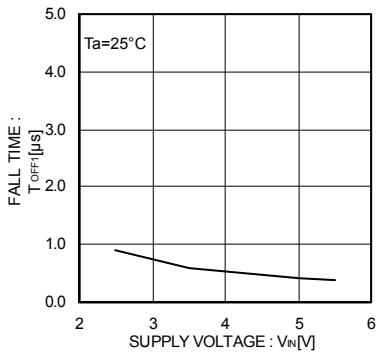

Fig.22 Output fall time

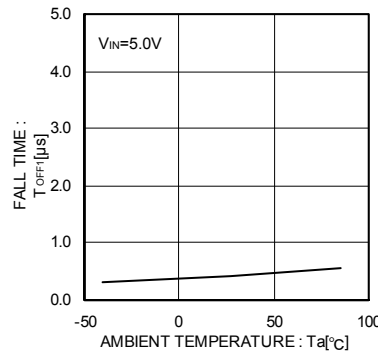

Fig.23 Output fall time

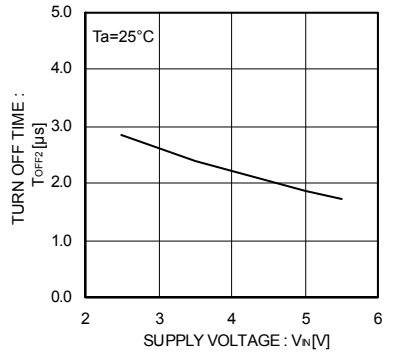

Fig.24 Output turn off time

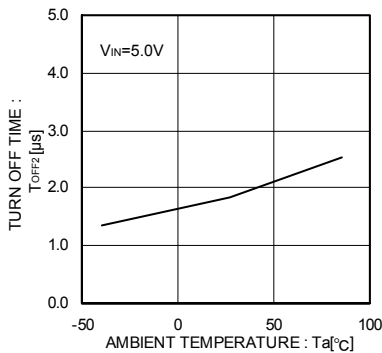

Fig.25 Output turn off time

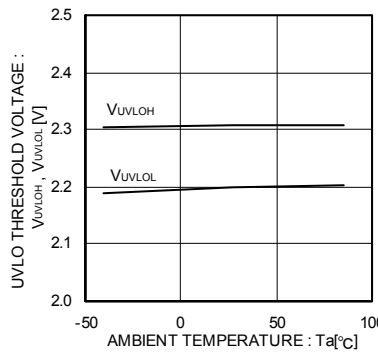

Fig.26 UVLO threshold voltage

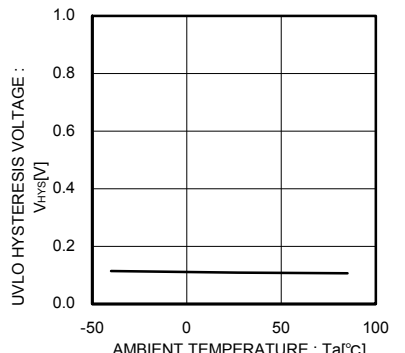

Fig.27 UVLO hysteresis voltage

● Waveform data

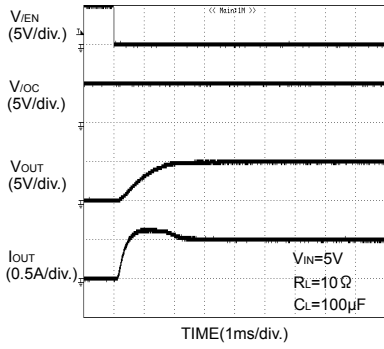

Fig.28 Output rise characteristic (BD2061AFJ)

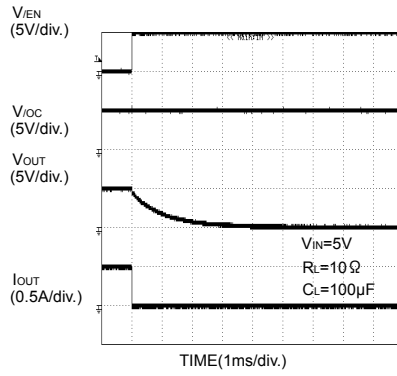

Fig.29 Output fall characteristic (BD2061AFJ)

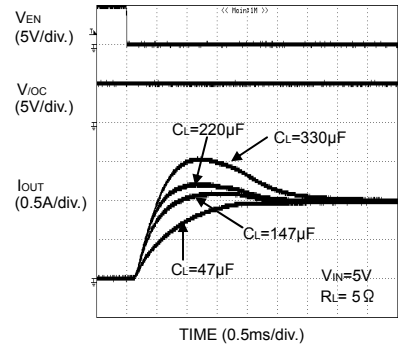

Fig.30 Inrush current response (BD2061AFJ)

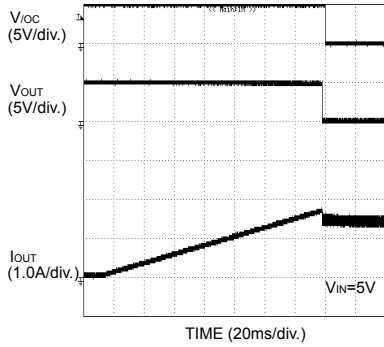

Fig.31 Over current response Ramped load (BD2061AFJ)

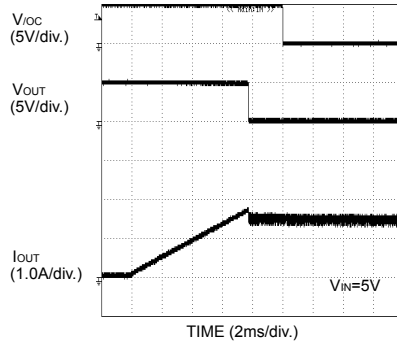

Fig.32 Over current response Ramped load (BD2061AFJ)

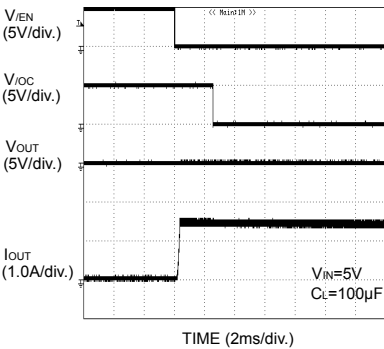

Fig.33 Over current response Enable to shortcircuit (BD2061AFJ)

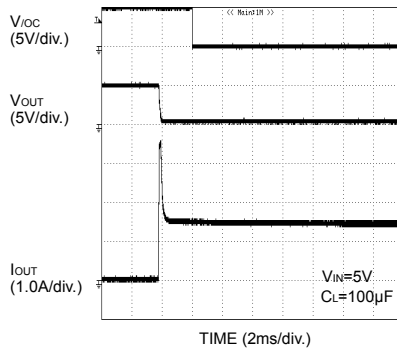

Fig.34 Over current response Enable to shortcircuit (BD2061AFJ)

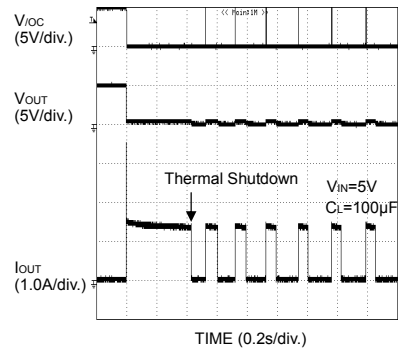

Fig.35 Over current response Enable to shortcircuit (BD2061AFJ)

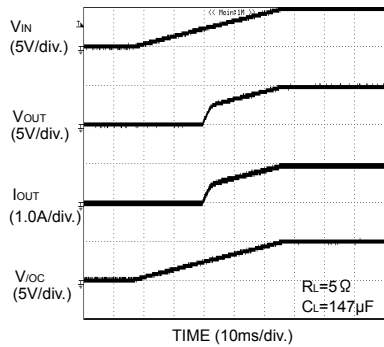

Fig.36 UVLO response Increasing V_{IN} (BD2061AFJ)

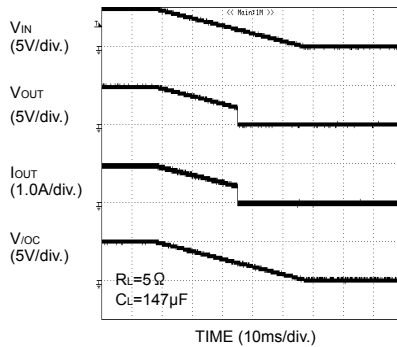

Fig.37 UVLO response Decreasing V_{IN} (BD2061AFJ)

Regarding the output rise/fall and over current detection characteristics of BD2065AFJ, refer to the characteristic of BD2061AFJ.

●Block diagram

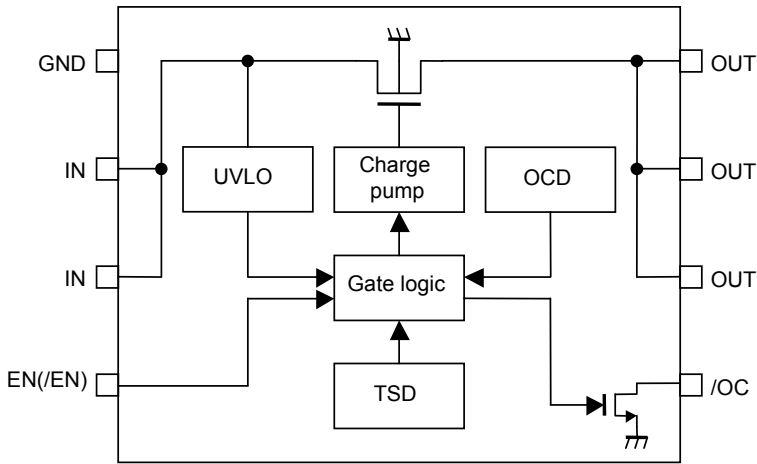

Fig.38 Block diagram

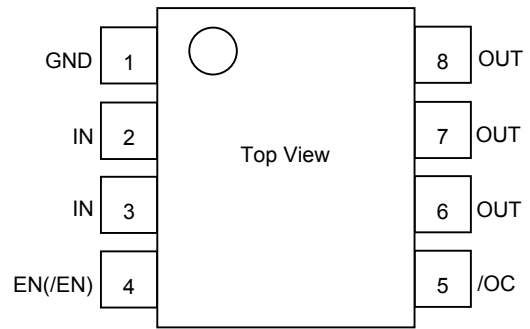

Fig.39 Pin Configuration

●Pin description

©BD2061AFJ

Pin No.	Symbol	I / O	Pin function
1	GND	I	Ground.
2, 3	IN	I	Power supply input. Input terminal to the power switch and power supply input terminal of the internal circuit. At use, connect each pin outside.
4	/EN	I	Enable input. Power switch on at Low level. High level input > 2.0V, Low level input < 0.8V.
5	/OC	O	Error flag output. Low at over current, thermal shutdown. Open drain output.
6, 7, 8	OUT	O	Power switch output. At use, connect each pin outside.

©BD2065AFJ

Pin No.	Symbol	I / O	Pin function
1	GND	I	Ground.
2, 3	IN	I	Power supply input. Input terminal to the power switch and power supply input terminal of the internal circuit. At use, connect each pin outside.
4	EN	I	Enable input. Power switch on at High level. High level input > 2.0V, Low level input < 0.8V
5	/OC	O	Error flag output. Low at over current, thermal shutdown. Open drain output.
6, 7, 8	OUT	O	Power switch output. At use, connect each pin outside.

● I/O circuit

Symbol	Pin No	Equivalent circuit
EN(/EN)	4	
/OC	5	
OUT	6,7,8	

● Functional description

1. Switch operation

IN terminal and OUT terminal are connected to the drain and the source of switch MOSFET respectively. And the IN terminal is used also as power source input to internal control circuit.

When the switch is turned on from EN/EN control input, IN terminal and OUT terminal are connected by a 80mΩ switch. In on status, the switch is bidirectional. Therefore, when the potential of OUT terminal is higher than that of IN terminal, current flows from OUT terminal to IN terminal.

Since a parasitic diode between the drain and the source of switch MOSFET is canceled, in the off status, it is possible to prevent current from flowing reversely from OUT to IN.

2. Thermal shutdown circuit (TSD)

If over current would continue, the temperature of the IC would increase drastically. If the junction temperature were beyond 140°C (typ.) in the condition of over current detection, thermal shutdown circuit operates and makes power switch turn off and outputs error flag (/OC). Then, when the junction temperature decreases lower than 120°C (typ.), power switch is turned on and error flag (/OC) is cancelled. Unless the fact of the increasing chips temperature is removed or the output of power switch is turned off, this operation repeats.

The thermal shutdown circuit operates when the switch is on (EN,/EN signal is active).

3. Over current detection (OCD)

The over current detection circuit limits current (I_{sc}) and outputs error flag (/OC) when current flowing in each switch MOSFET exceeds a specified value. There are three types of response against over current. The over current detection circuit works when the switch is on (EN,/EN signal is active).

3-1. When the switch is turned on while the output is in shortcircuit status

When the switch is turned on while the output is in shortcircuit status or so, the switch gets in current limit status soon.

3-2. When the output shortcircuits while the switch is on

When the output shortcircuits or large capacity is connected while the switch is on, very large current flows until the over current limit circuit reacts. When the current detection, limit circuit works, current limitation is carried out.

3-3. When the output current increases gradually

When the output current increases gradually, current limitation does not work until the output current exceeds the over current detection value. When it exceeds the detection value, current limitation is carried out.

4. Under voltage lockout (UVLO)

UVLO circuit prevents the switch from turning on until the V_{IN} exceeds 2.3V(Typ.). If the V_{IN} drops below 2.2V(Typ.) while the switch turns on, then UVLO shuts off the power switch. UVLO has hysteresis of a 100mV(Typ). Under voltage lockout circuit works when the switch is on (EN,/EN signal is active).

5. Error flag (/OC) output

Error flag output is N-MOS open drain output. At detection of over current, thermal shutdown, low level is output.

Over current detection has delay filter. This delay filter prevents instantaneous current detection such as inrush current at switch on, hot plug from being informed to outside.

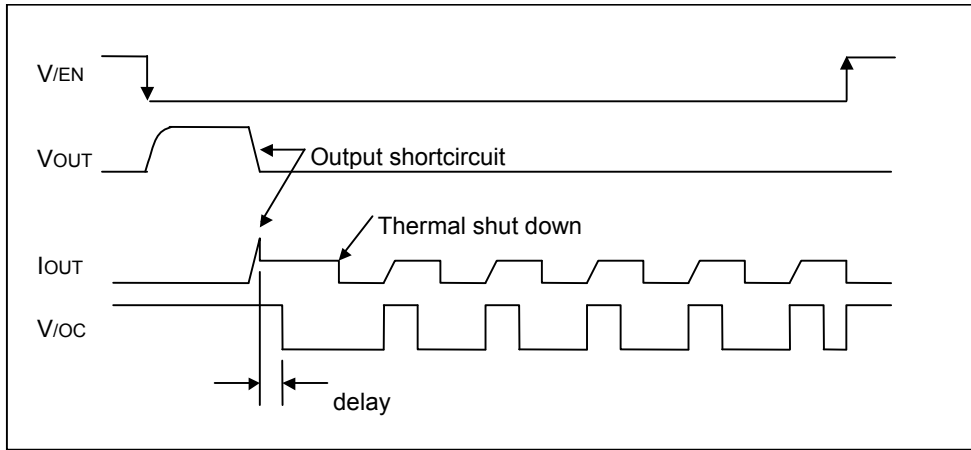

Fig.40 Over current detection, thermal shutdown timing (BD2061AFJ)

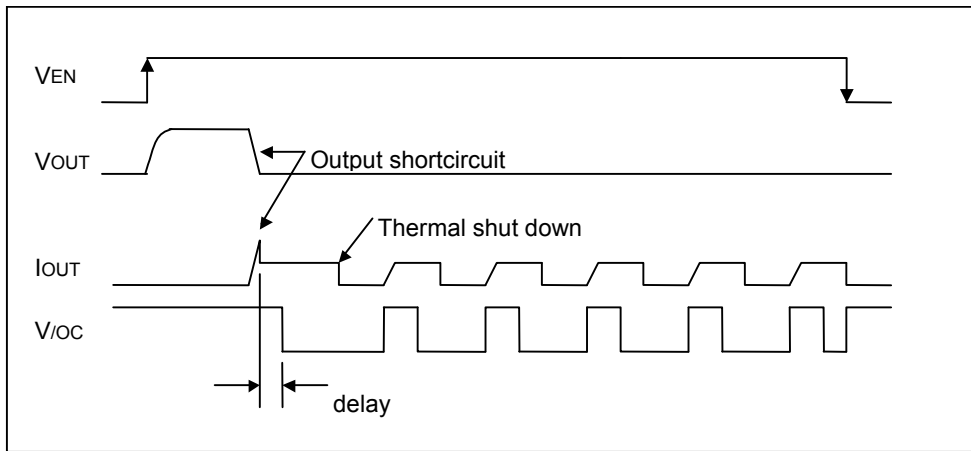

Fig.41 Over current detection, thermal shutdown timing (BD2065AFJ)

● Typical application circuit

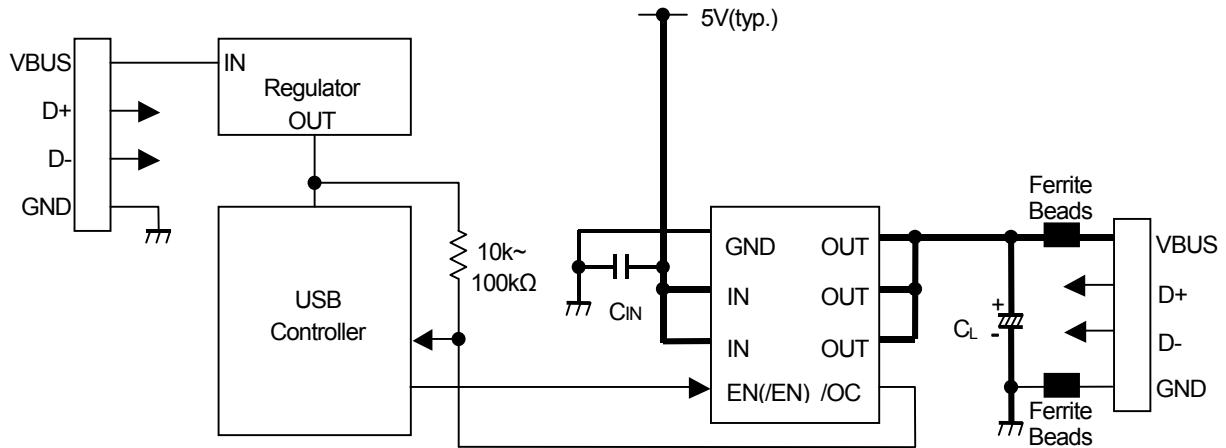

Fig.42 Typical application circuit

● Application information

When excessive current flows owing to output shortcircuit or so, ringing occurs by inductance of power source line to IC, and may cause bad influences upon IC actions. In order to avoid this case, connect a bypass capacitor by IN terminal and GND terminal of IC. 1μF or higher is recommended.

Pull up /OC output by resistance 10kΩ ~ 100kΩ.

Set up value which satisfies the application as C_L and Ferrite Beads.

This system connection diagram doesn't guarantee operating as the application.

The external circuit constant and so on is changed and it uses, in which there are adequate margins by taking into account external parts or dispersion of IC including not only static characteristics but also transient characteristics.

● Power dissipation character
(SOP-J8)

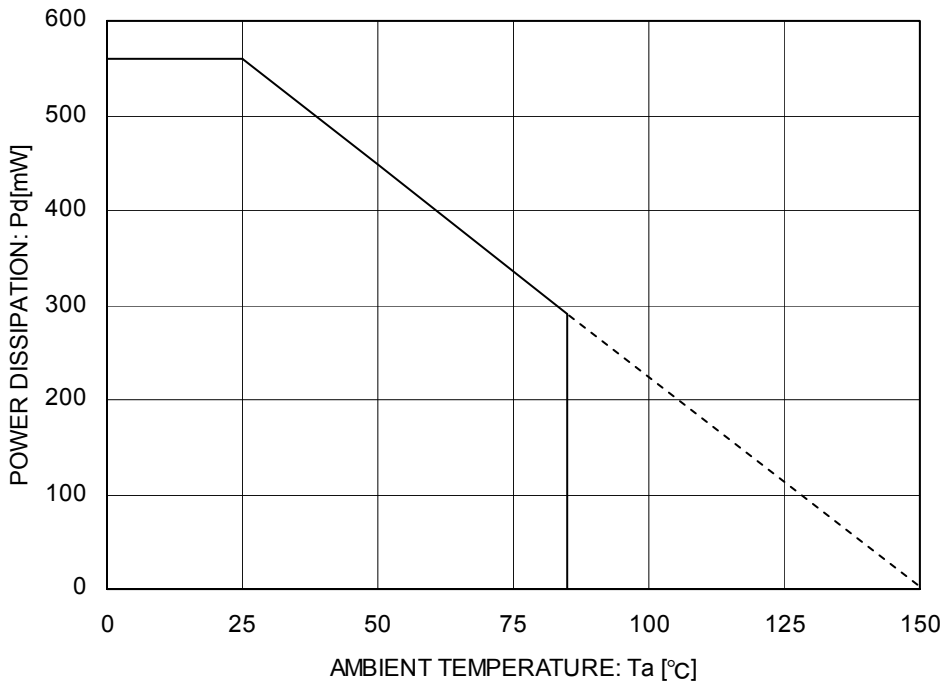

Fig.43 Power dissipation curve (Pd-Ta Curve)

●Notes for use

- (1) Absolute Maximum Ratings
An excess in the absolute maximum ratings, such as supply voltage, temperature range of operating conditions, etc., can break down devices, thus making impossible to identify breaking mode such as a short circuit or an open circuit. If any special mode exceeding the absolute maximum ratings is assumed, consideration should be given to take physical safety measures including the use of fuses, etc.
- (2) Operating conditions
These conditions represent a range within which characteristics can be provided approximately as expected. The electrical characteristics are guaranteed under the conditions of each parameter.
- (3) Reverse connection of power supply connector
The reverse connection of power supply connector can break down ICs. Take protective measures against the breakdown due to the reverse connection, such as mounting an external diode between the power supply and the IC's power supply terminal.
- (4) Power supply line
Design PCB pattern to provide low impedance for the wiring between the power supply and the GND lines. In this regard, for the digital block power supply and the analog block power supply, even though these power supplies has the same level of potential, separate the power supply pattern for the digital block from that for the analog block, thus suppressing the diffraction of digital noises to the analog block power supply resulting from impedance common to the wiring patterns. For the GND line, give consideration to design the patterns in a similar manner. Furthermore, for all power supply terminals to ICs, mount a capacitor between the power supply and the GND terminal. At the same time, in order to use an electrolytic capacitor, thoroughly check to be sure the characteristics of the capacitor to be used present no problem including the occurrence of capacity dropout at a low temperature, thus determining the constant.
- (5) GND voltage
Make setting of the potential of the GND terminal so that it will be maintained at the minimum in any operating state. Furthermore, check to be sure no terminals are at a potential lower than the GND voltage including an actual electric transient.
- (6) Short circuit between terminals and erroneous mounting
In order to mount ICs on a set PCB, pay thorough attention to the direction and offset of the ICs. Erroneous mounting can break down the ICs. Furthermore, if a short circuit occurs due to foreign matters entering between terminals or between the terminal and the power supply or the GND terminal, the ICs can break down.
- (7) Operation in strong electromagnetic field
Be noted that using ICs in the strong electromagnetic field can malfunction them.
- (8) Inspection with set PCB
On the inspection with the set PCB, if a capacitor is connected to a low-impedance IC terminal, the IC can suffer stress. Therefore, be sure to discharge from the set PCB by each process. Furthermore, in order to mount or dismount the set PCB to/from the jig for the inspection process, be sure to turn OFF the power supply and then mount the set PCB to the jig. After the completion of the inspection, be sure to turn OFF the power supply and then dismount it from the jig. In addition, for protection against static electricity, establish a ground for the assembly process and pay thorough attention to the transportation and the storage of the set PCB.
- (9) Input terminals
In terms of the construction of IC, parasitic elements are inevitably formed in relation to potential. The operation of the parasitic element can cause interference with circuit operation, thus resulting in a malfunction and then breakdown of the input terminal. Therefore, pay thorough attention not to handle the input terminals, such as to apply to the input terminals a voltage lower than the GND respectively, so that any parasitic element will operate. Furthermore, do not apply a voltage to the input terminals when no power supply voltage is applied to the IC. In addition, even if the power supply voltage is applied, apply to the input terminals a voltage lower than the power supply voltage or within the guaranteed value of electrical characteristics.
- (10) Ground wiring pattern
If small-signal GND and large-current GND are provided, It will be recommended to separate the large-current GND pattern from the small-signal GND pattern and establish a single ground at the reference point of the set PCB so that resistance to the wiring pattern and voltage fluctuations due to a large current will cause no fluctuations in voltages of the small-signal GND. Pay attention not to cause fluctuations in the GND wiring pattern of external parts as well.
- (11) External capacitor
In order to use a ceramic capacitor as the external capacitor, determine the constant with consideration given to a degradation in the nominal capacitance due to DC bias and changes in the capacitance due to temperature, etc.
- (12) Thermal shutdown circuit (TSD)
When junction temperatures become detected temperatures or higher, the thermal shutdown circuit operates and turns a switch OFF. The thermal shutdown circuit, which is aimed at isolating the LSI from thermal runaway as much as possible, is not aimed at the protection or guarantee of the LSI. Therefore, do not continuously use the LSI with this circuit operating or use the LSI assuming its operation.
- (13) Thermal design
Perform thermal design in which there are adequate margins by taking into account the power dissipation (Pd) in actual states of use.

● Ordering part number

B	D
---	---

Part No.

2	0	6	1	A
---	---	---	---	---

Part No.
2061A
2065A

F	J
---	---

Package
FJ: SOP-J8

E	2
---	---

Packaging and forming specification
E2: Embossed tape and reel
(SOP-J8)

SOP-J8

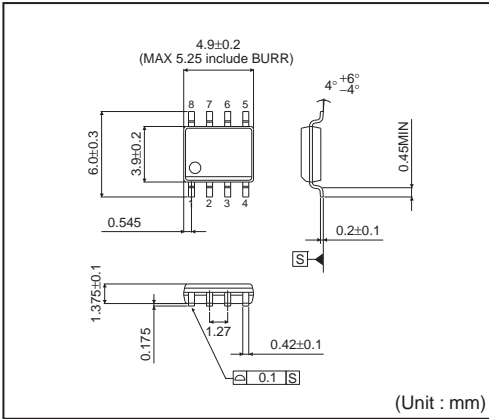

<Tape and Reel information>

Tape	Embossed carrier tape
Quantity	2500pcs
Direction of feed	E2 (The direction is the 1 pin of product is at the upper left when you hold reel on the left hand and you pull out the tape on the right hand)

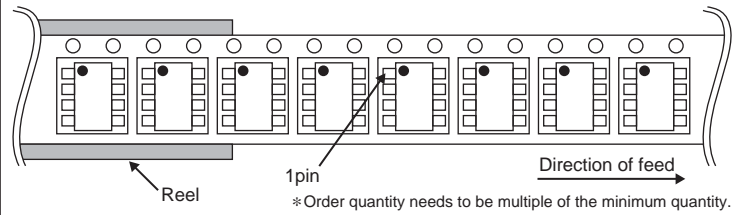

Notes

No copying or reproduction of this document, in part or in whole, is permitted without the consent of ROHM Co.,Ltd.

The content specified herein is subject to change for improvement without notice.

The content specified herein is for the purpose of introducing ROHM's products (hereinafter "Products"). If you wish to use any such Product, please be sure to refer to the specifications, which can be obtained from ROHM upon request.

Examples of application circuits, circuit constants and any other information contained herein illustrate the standard usage and operations of the Products. The peripheral conditions must be taken into account when designing circuits for mass production.

Great care was taken in ensuring the accuracy of the information specified in this document. However, should you incur any damage arising from any inaccuracy or misprint of such information, ROHM shall bear no responsibility for such damage.

The technical information specified herein is intended only to show the typical functions of and examples of application circuits for the Products. ROHM does not grant you, explicitly or implicitly, any license to use or exercise intellectual property or other rights held by ROHM and other parties. ROHM shall bear no responsibility whatsoever for any dispute arising from the use of such technical information.

The Products specified in this document are intended to be used with general-use electronic equipment or devices (such as audio visual equipment, office-automation equipment, communication devices, electronic appliances and amusement devices).

The Products specified in this document are not designed to be radiation tolerant.

While ROHM always makes efforts to enhance the quality and reliability of its Products, a Product may fail or malfunction for a variety of reasons.

Please be sure to implement in your equipment using the Products safety measures to guard against the possibility of physical injury, fire or any other damage caused in the event of the failure of any Product, such as derating, redundancy, fire control and fail-safe designs. ROHM shall bear no responsibility whatsoever for your use of any Product outside of the prescribed scope or not in accordance with the instruction manual.

The Products are not designed or manufactured to be used with any equipment, device or system which requires an extremely high level of reliability the failure or malfunction of which may result in a direct threat to human life or create a risk of human injury (such as a medical instrument, transportation equipment, aerospace machinery, nuclear-reactor controller, fuel-controller or other safety device). ROHM shall bear no responsibility in any way for use of any of the Products for the above special purposes. If a Product is intended to be used for any such special purpose, please contact a ROHM sales representative before purchasing.

If you intend to export or ship overseas any Product or technology specified herein that may be controlled under the Foreign Exchange and the Foreign Trade Law, you will be required to obtain a license or permit under the Law.



Thank you for your accessing to ROHM product informations.
More detail product informations and catalogs are available, please contact us.

ROHM Customer Support System

<http://www.rohm.com/contact/>